

Product Description

The QPM1002 is a Gallium Nitride MMIC front-end module (FEM) designed for X-Band radar applications within the 8.5 – 10.5 GHz range. The MMIC combines a T/R switch, low-noise amplifier, and a power amplifier. The receive path offers 25 dB gain with low noise figure of 2.2 dB. The transmit path offers a small signal gain of 33 dB, it can deliver 3 W of saturated power with a PAE of 32%, with a 25 dB of large signal gain. The FEM is robust up to 2 W of input power into the ANT port eliminating the need for a limiter.

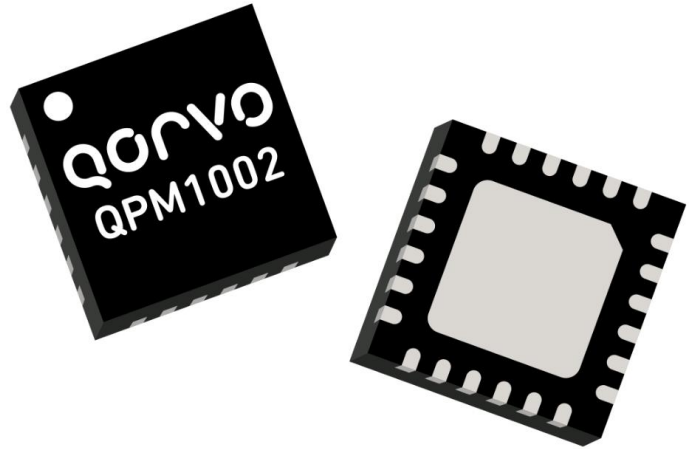

The QPM1002 is fabricated on Qorvo's QGaN25 0.25um GaN-on-SiC process. The 5 x 5 mm QFN surface mount package with over-mold encapsulant, coupled with high thermal conductivity die-attach process, allows the QPM1002 to perform well in a high temperature environment. Its compact size supports tight lattice spacing requirements needed for X-Band phased array radar applications.

Functional Block Diagram

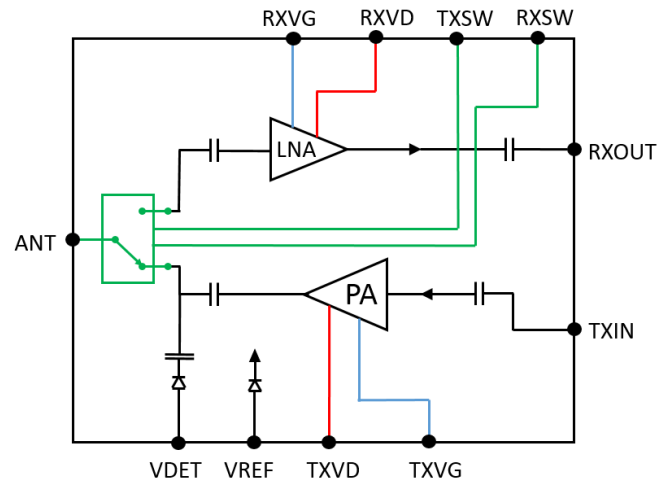

Product Features

- Frequency Range: 8.5 – 10.5 GHz
- RX Noise Figure: 2.2 dB
- RX Small Signal Gain: 25 dB
- RX Saturated Power: 16 dBm
- RX Output TOI: 22dBm
- TX Small Signal Gain: 33 dB
- TX Large Signal Gain: 25 dB
- TX Saturated Power: 35 dBm, Pulsed
- TX PAE: 32% @ 35 dBm Pout, Pulsed
- TX Output TOI @ 6 dBm Pin / tone: 38.5 dBm
- TX Harmonics Suppression: 35 dBc
- Package Dimensions: 5 x 5 x 0.85 mm

*Performance is typical at room temperature.
Please reference electrical specification table and data plots for more details.*

Applications

- Electronics Warfare (EW)
- Commercial and Military Radar
- Communications

Ordering Information

Part No.	Description
QPM1002SR	QPM1002 Tape and Reel, Qty 100
QPM1002	QPM1002 Shipping Tray, Qty 250
QPM1002TR7	QPM1002 Tape and Reel, Qty 750
QPM1002EVB1	QPM1002 Evaluation Board

Normal Operating Conditions

Parameter	Value
RX Drain Voltage (RXVD) ^{1, 3}	10 V
RX Drain Quiescent Current (RXIDQ)	20 mA
RX Gate Control (RXVG) ²	-2.5 V
TX Drain Voltage (TXVD)	25 V
TX Drain Quiescent Current (TXIDQ)	110 mA
TX Gate Voltage (TXVG) ²	-2.5 V
Control Voltage (TXSW / RXSW)	Transmit: -28V / 0 V; Receive: 0V / -28V
Operating Temperature Range	-40 to 95 °C

1. Electrical specifications are measured at specified test conditions. Specifications are not guaranteed over all recommended operating conditions.
2. Gate voltage shown are typical, can be adjusted to set required drain current.
3. Drain of LNA is switched off by internal switch when in transmit mode. In receive mode, the PA should be biased off.

Absolute Maximum Ratings

Parameter	Value
Drain Voltage (TXVD and RXVD)	32 V
Drain Current (TXID)	600 mA
Drain Current (RXID)	60 mA
Gate Voltage (RXVG, TXVG)	0 to -5 V
Gate Current (RXIG)	10 mA
Gate Current (TXIG)	20 mA
Switch Control Voltage (TXSW, RXSW)	0 to -50 V
Switch Control Current	20 mA
RF Input Power (All RF ports, 85 °C)	33 dBm
Channel Temperature, T _{CH}	225 °C
Mounting Temperature (30 seconds)	260 °C
Storage Temperature	-55 to 150 °C

Operation of this device outside the parameter ranges given above may cause permanent damage. These are stress ratings only, and functional operation of the device at these conditions is not implied.

Electrical Specifications, Receive

Test conditions unless otherwise noted: RXVD = 10 V, RXIDQ = 20 mA, RXSW = - 28 V, TXSW = 0 V, Transmit channel biased off.
Data de-embedded to device reference plane, 25 °C

Parameter	Min	Typical	Max	Units
Frequency	8.5		10.5	GHz
Small Signal Gain	23	25	28.5	dB
Noise Figure		2.2		dB
Input Return Loss		13		dB
Output Return Loss		12		dB
Saturated Output Power, CW Mode		16		dBm
Output TOI @ -31 dBm Pin / Tone, CW Mode		22		dBm
Gate Leakage Current (RXVG leak, RXVD = 10 V, RXVG = -3.7 V)	-0.44	0		mA
Switch Settling Time, Rising Edge ¹			20	nS
Switch Settling Time, Falling Edge ²			100	nS
Gain Temperature Coefficient		-0.04		dB/°C

- 1 From 50% trigger signal to 90 % of RF on (Trigger signal to switch driver to DUT).
2 From 50% trigger signal to 10 % of RF off (Trigger signal to switch driver to DUT).

Electrical Specifications, Transmit

Test conditions unless otherwise noted: TXVD = 25 V, TXIDQ = 110 mA, RXSW = 0V, TXSW = - 28 V
Data de-embedded to device reference plane, 25 °C

Parameter	Min	Typical	Max	Units
Frequency	8.5		10.5	GHz
Small Signal Gain		33		dB
Large Signal Gain		25		dB
Input Return Loss		15		dB
Output Return Loss		15		dB
Saturated Output Power @ 8.5 GHz to 9.5 GHz ¹	33	35		dBm
Saturated Output Power @ 10 GHz ¹	32	35		dBm
Saturated Output Power @ 10.5 GHz ¹	31.5	35		dBm
PAE at Saturated Power (@ 10 dBm Pin) ¹		32		%
Output TOI @ 6 dBm Pin / tone, CW Mode		38.5		dBm
Harmonic Suppression, CW Mode		35		dBc
Power Detection Output (VREF – VDET)	0		0.3	V
Gate Leakage Current (TXVG leak, TXVD = 10 V, TXVG = -3.7 V)	- 2.37	0		mA
Switch Settling Time, Rising Edge ²			40	nS
Switch Settling Time, Falling Edge ³			60	nS
Gain Temperature Coefficient		-0.05		dB/°C

1. Power and PAE measured with DC drain pulsed, PW = 100 uS, Duty Cycle = 10%.
2. From 50% trigger signal to 90 % of RF on (Trigger signal to switch driver to DUT)
3. From 50% trigger signal to 10 % of RF off (Trigger signal to switch driver to DUT)

Small Signal Performance, Receive

Test Conditions unless otherwise stated: RXVD = 10 V, RXIDQ = 20 mA, RXSW = -28 V, TXSW = 0 V, 25 °C
Transmit channel biased off.

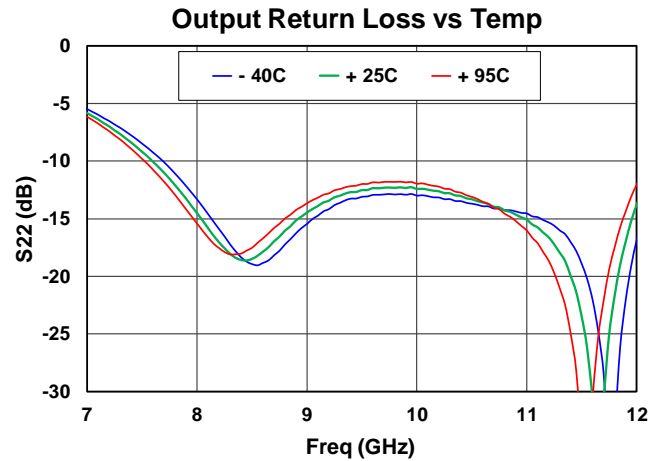
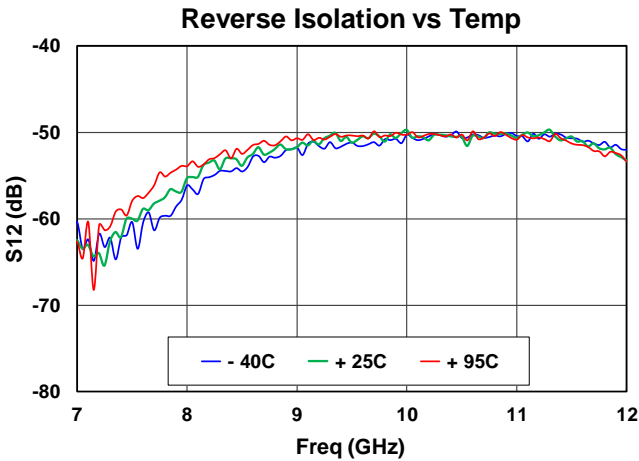
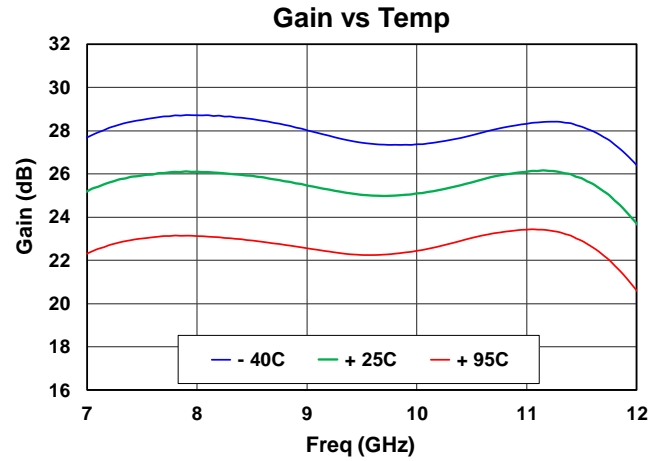
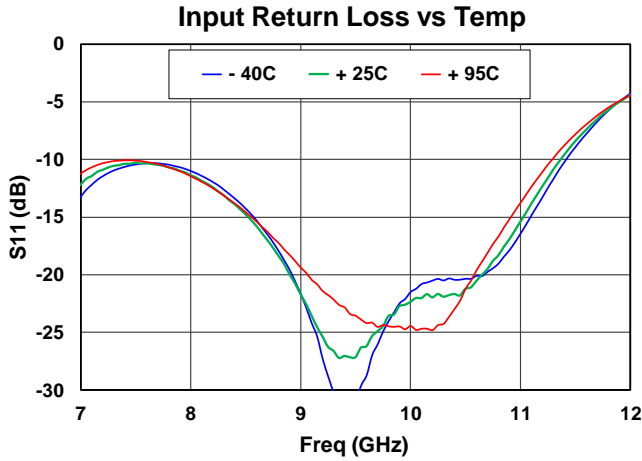

Small Signal Performance, Receive

Test Conditions unless otherwise stated: RXVD = 10 V, RXIDQ = 20 mA, RXSW = -28 V, TXSW = 0 V, 25 °C
Transmit channel biased off.

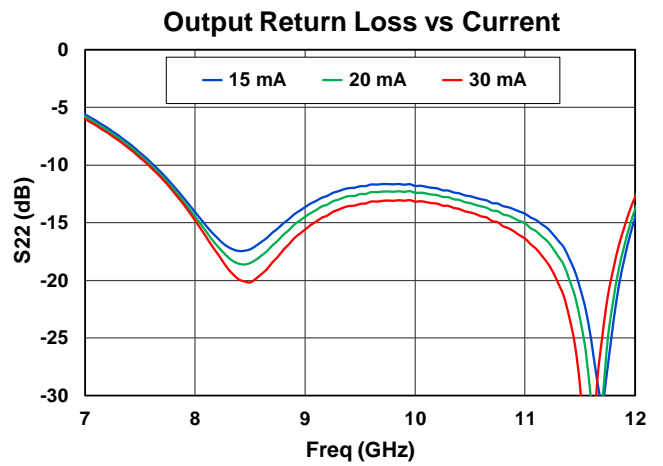
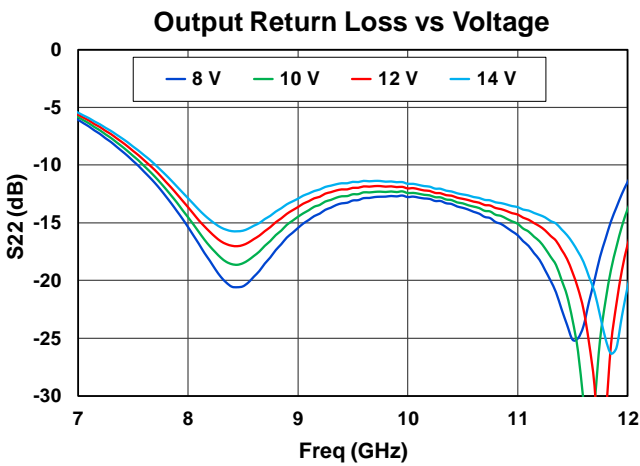
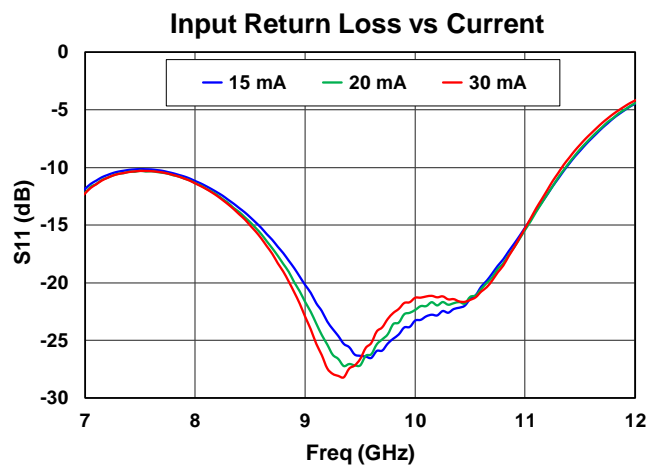
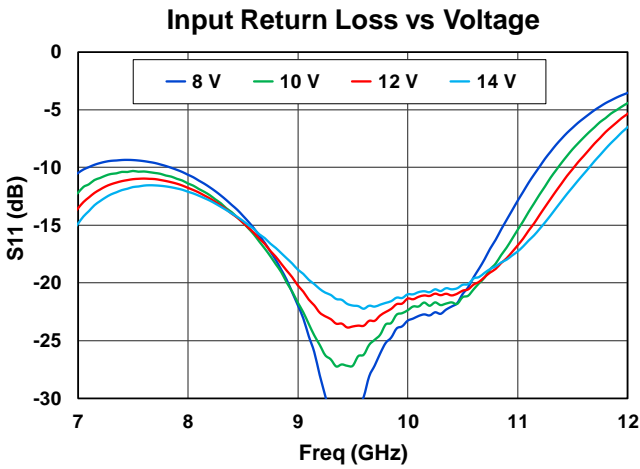
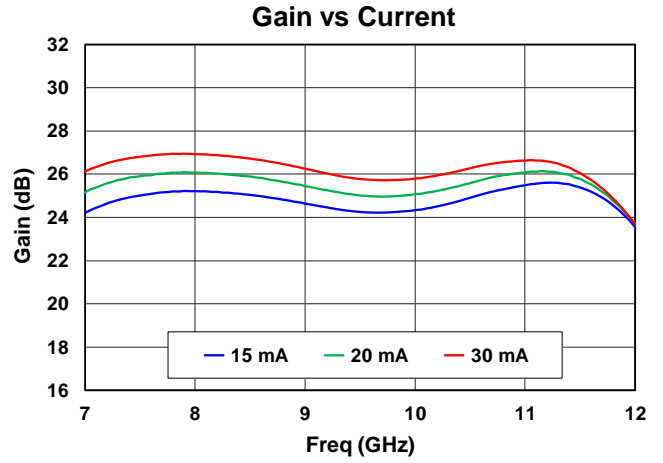
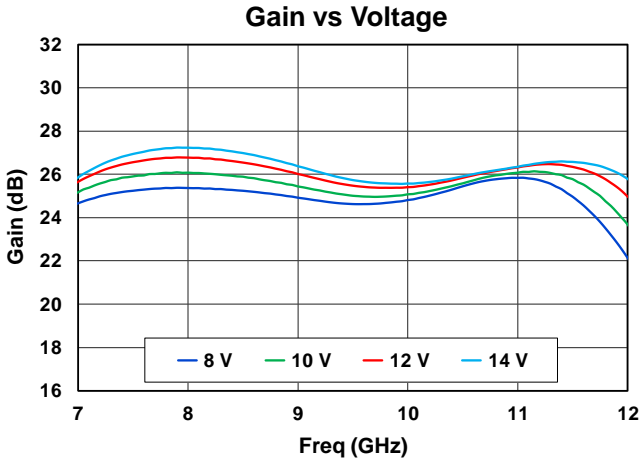

Noise Figure and Isolation

Test Conditions unless otherwise stated: VD = 10 V, RXIDQ = 20 mA, RXSW = -28 V, TXSW = 0 V, 25 °C
Transmit channel biased off.

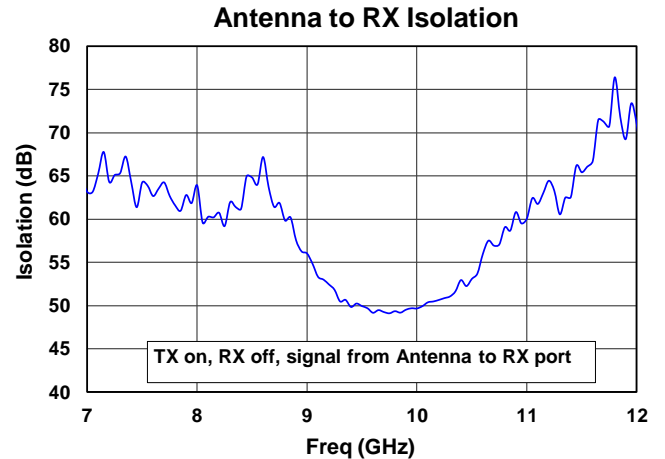
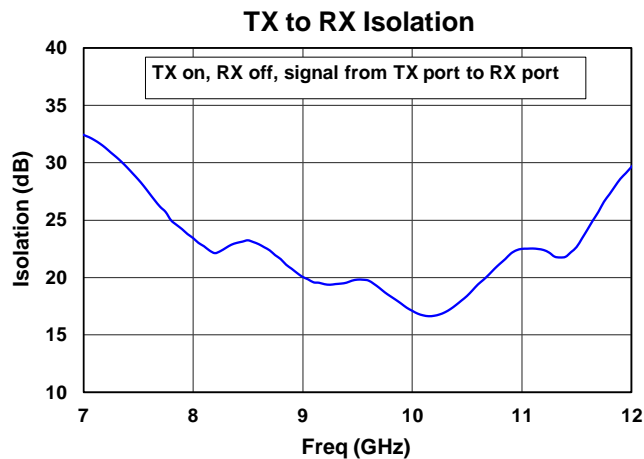
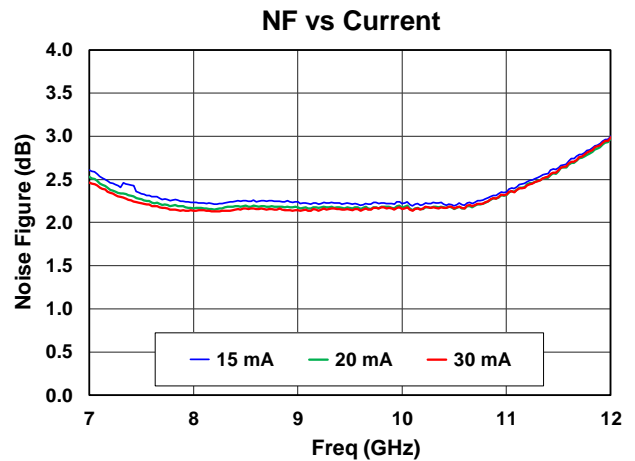
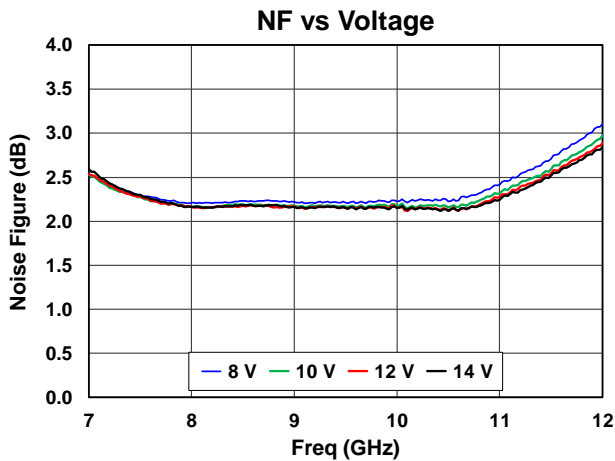
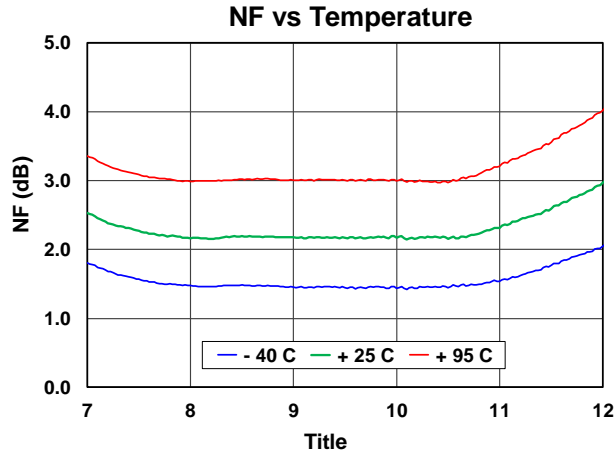

Power Performance, Receive

Test Conditions unless otherwise stated: VD = 10 V, RXIDQ = 20 mA, RXSW = -28 V, TXSW = 0 V
CW Mode, Pin = 5 dBm, transmit channel biased off., 25 °C

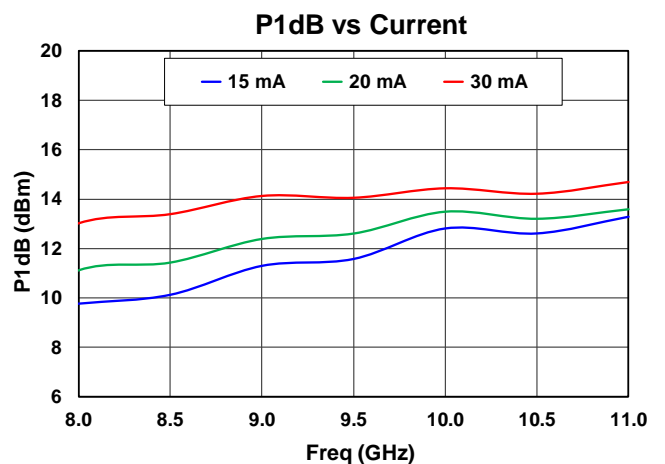
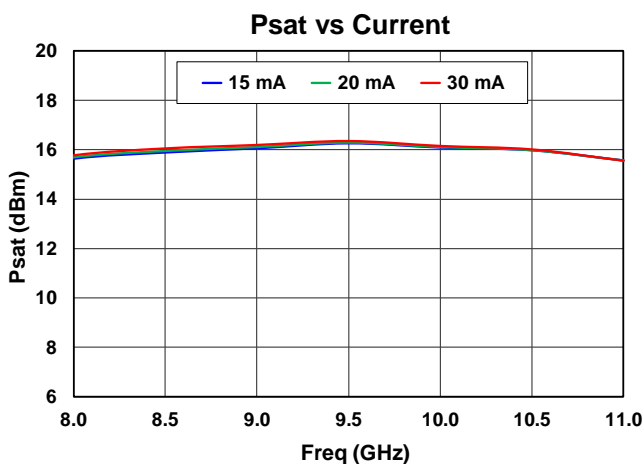
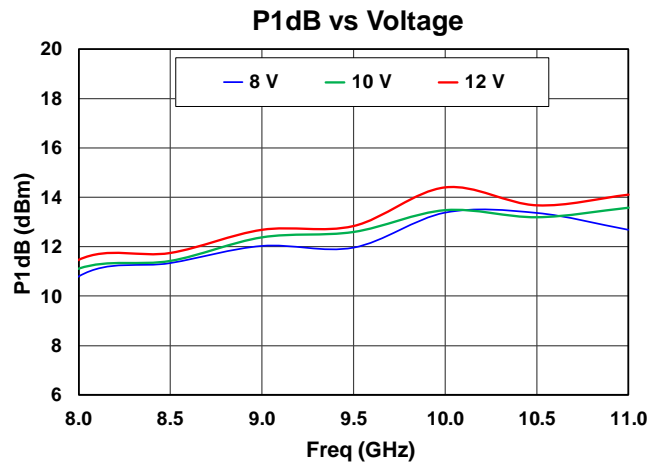
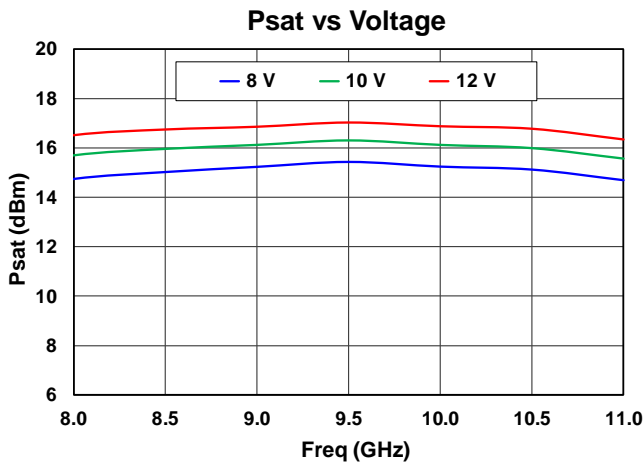
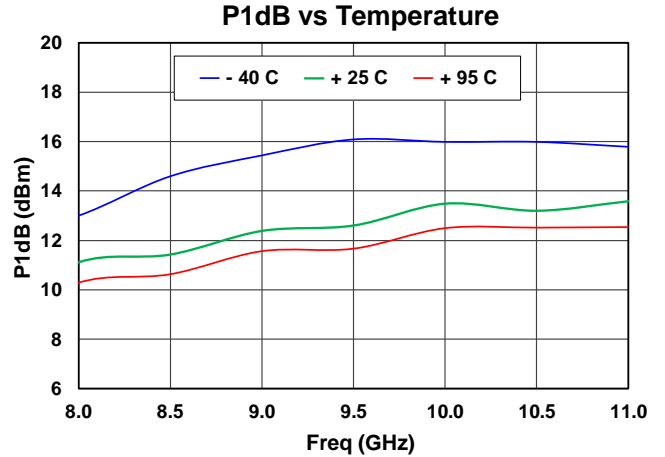
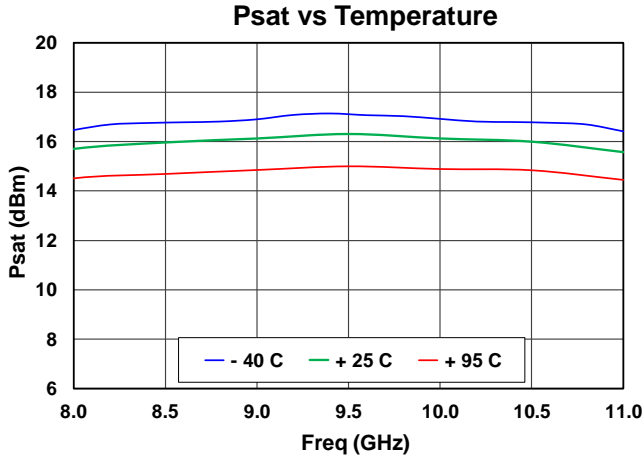

Power Sweep, Receive

Test Conditions unless otherwise stated: $V_D = 10\text{ V}$, $R_{XIDQ} = 20\text{ mA}$, $R_{XSW} = -28\text{ V}$, $R_{TSW} = 0\text{ V}$
CW Mode, transmit channel biased off, $25\text{ }^\circ\text{C}$

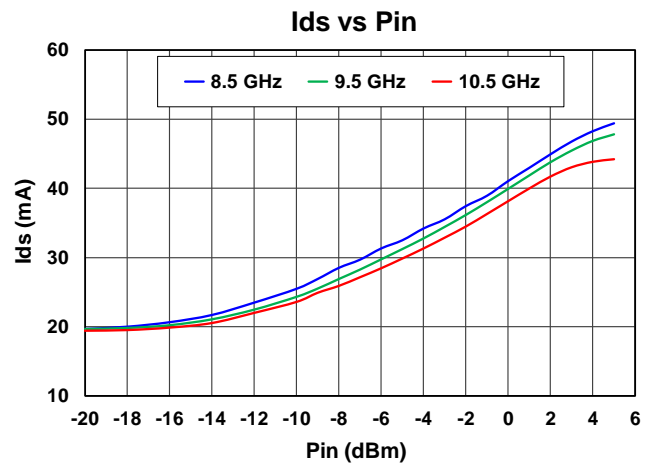
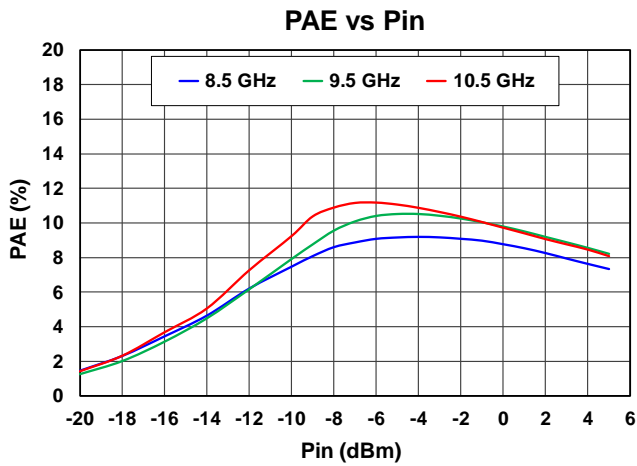
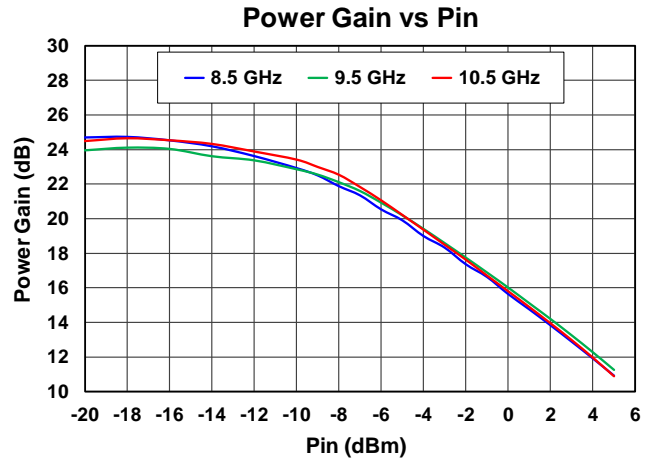
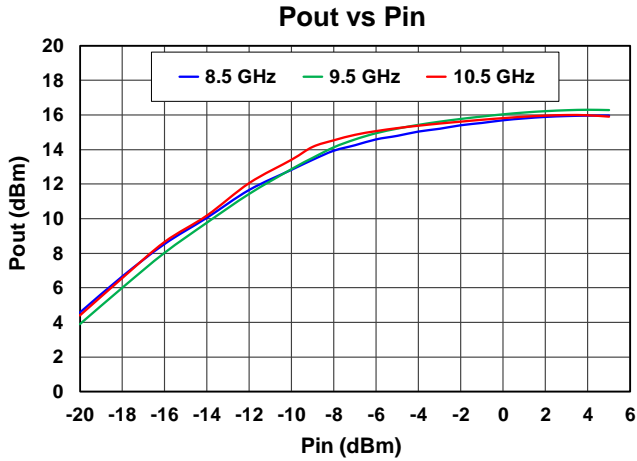

Linearity, Receive

Test Conditions unless otherwise stated: Transmit channel biased off, 25 °C
VD = 10 V, RXIDQ = 20 mA, RXSW = -28 V, TXSW = 0 V, CW Mode, Tone spacing = 20 MHz.

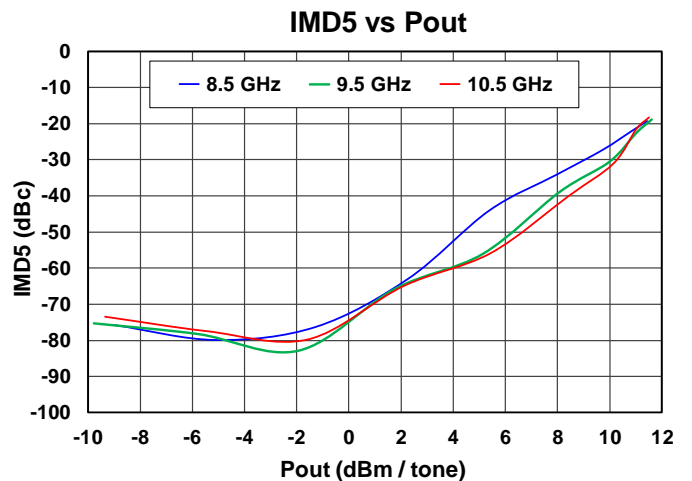
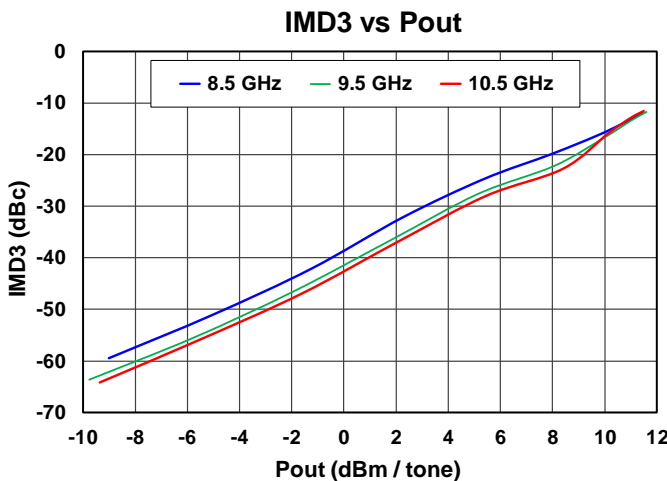
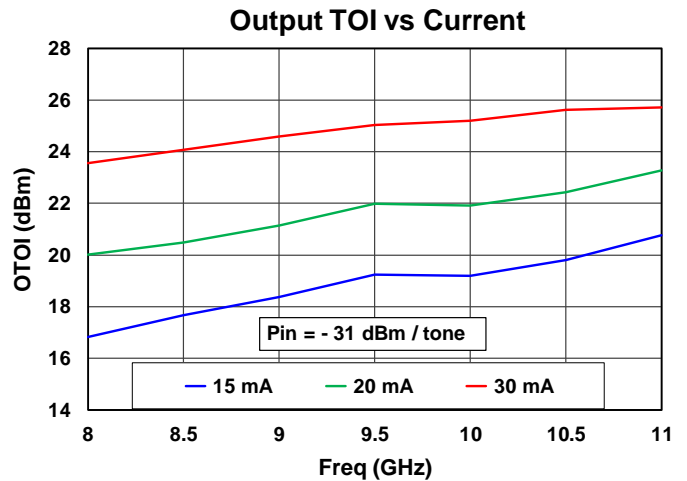
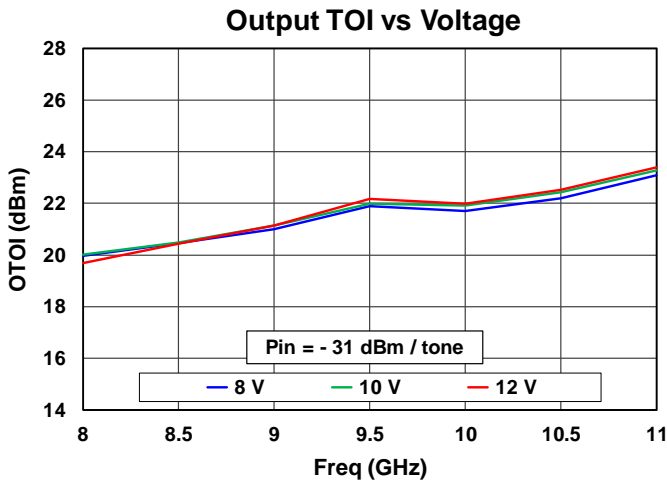
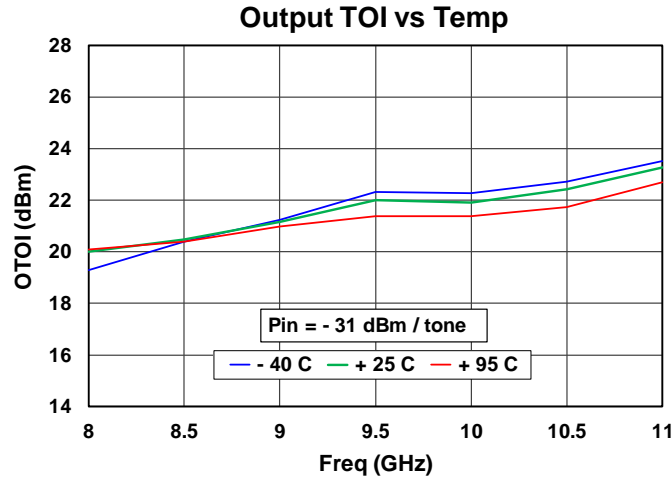

Small Signal Performance, Transmit

Test Conditions unless otherwise stated: TXVD = 25 V, TXIDQ = 110 mA, RXSW = 0V, TXSW = -28 V, 25 °C

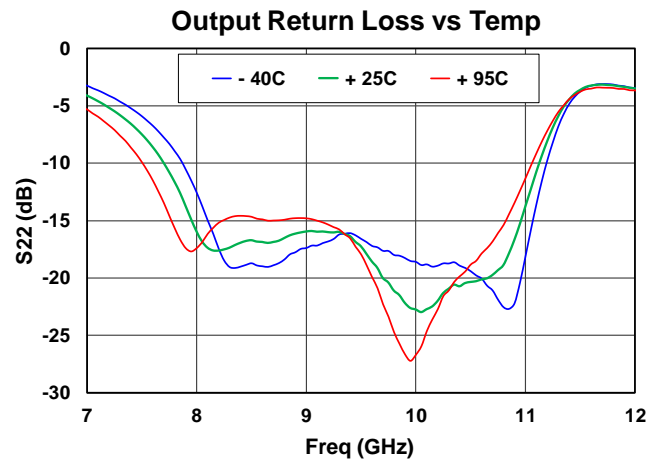
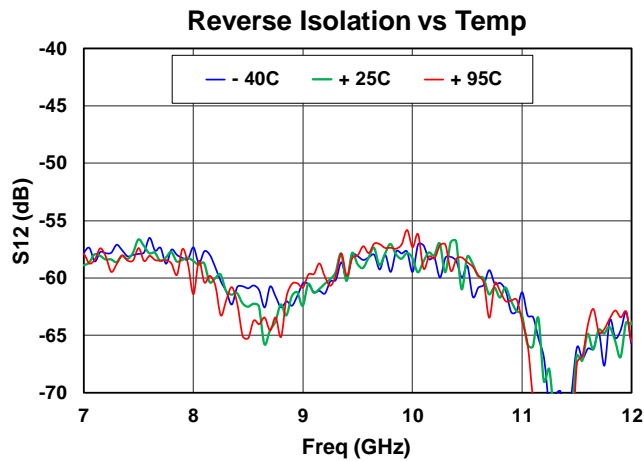
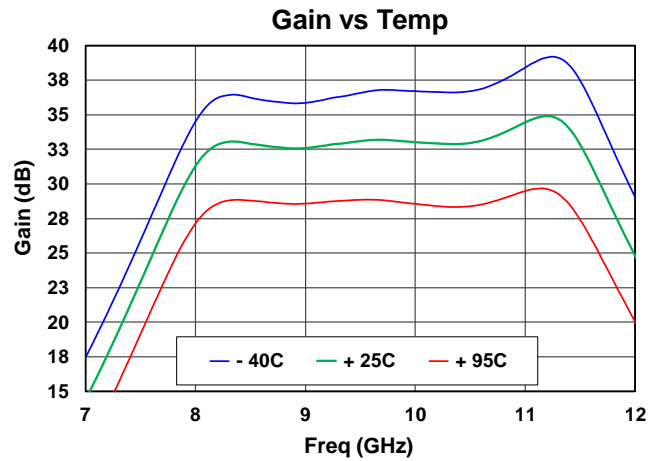
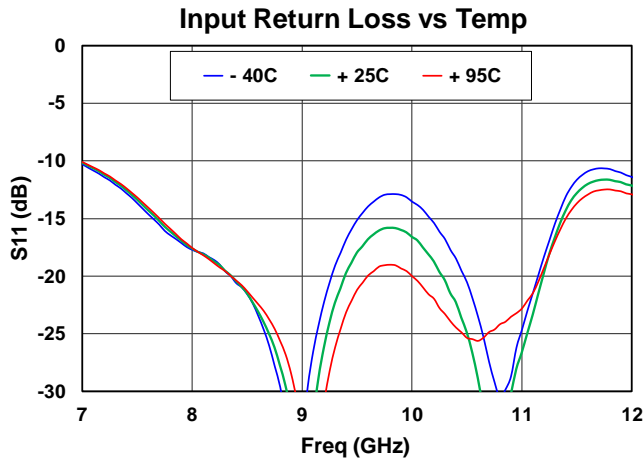

Small Signal Performance, Transmit

Test Conditions unless otherwise stated: VD = 25 V, TXIDQ = 110 mA, RXSW = 0V, TXSW = -28 V, 25 °C

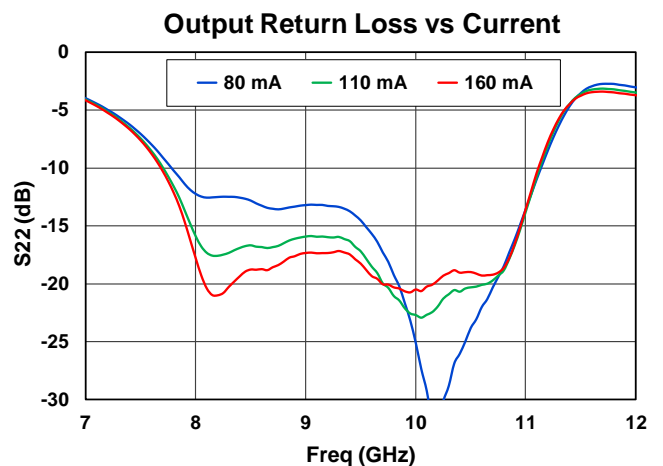
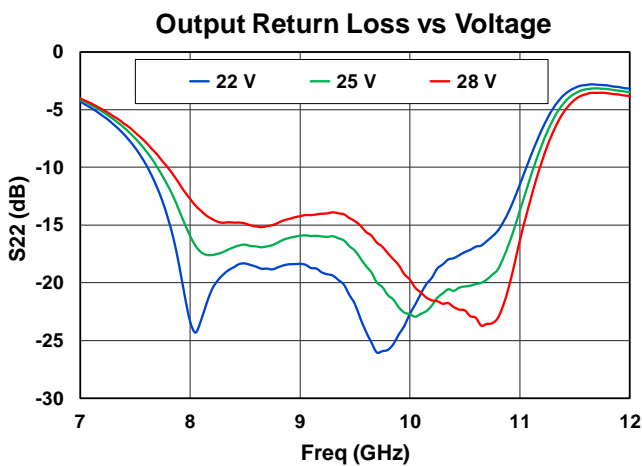
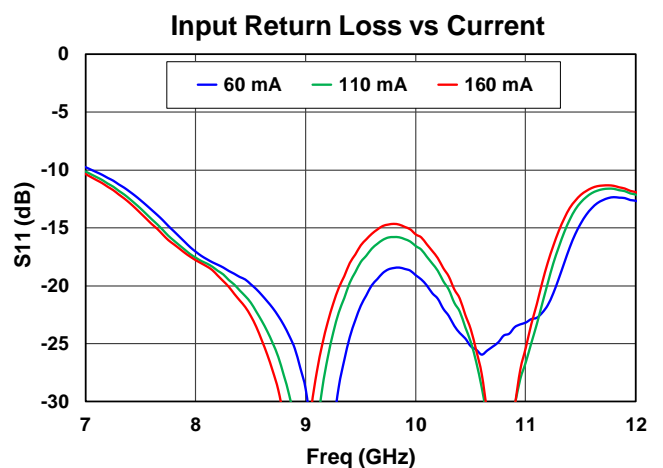
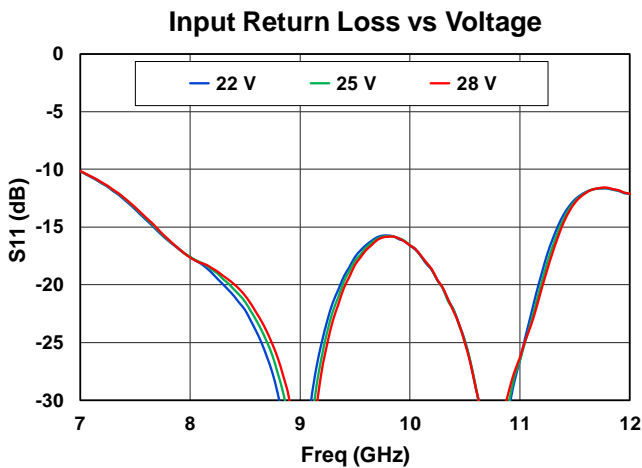
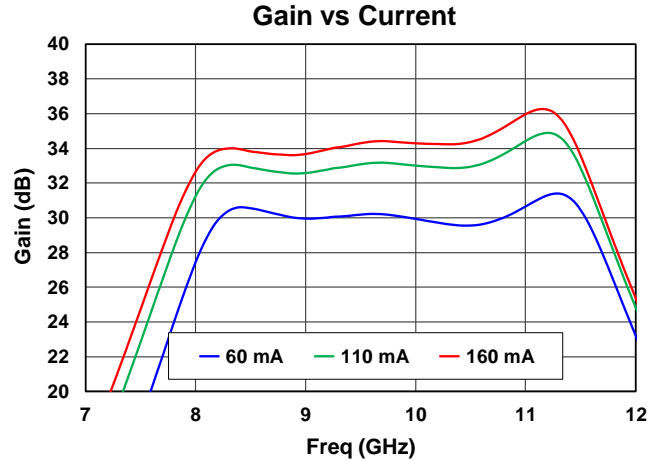
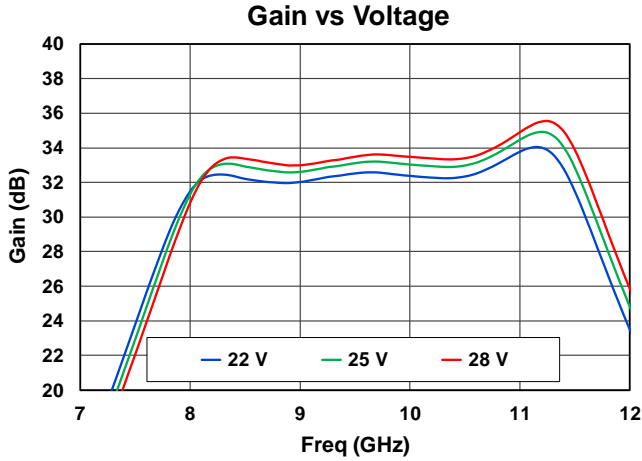

Power Performance, Transmit

Test Conditions unless otherwise stated: TXVD = 25 V, TXIDQ = 110 mA, RXSW = 0V, TXSW = -28 V
Pulse Mode, Pin = 16 dBm, PW = 100 uS, DC = 10%, 25 °C

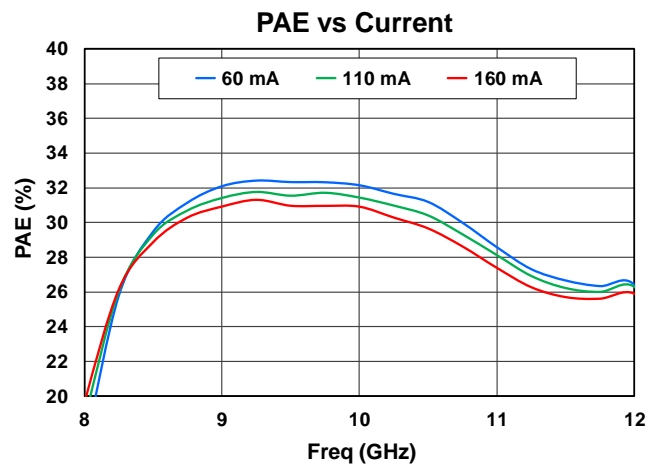
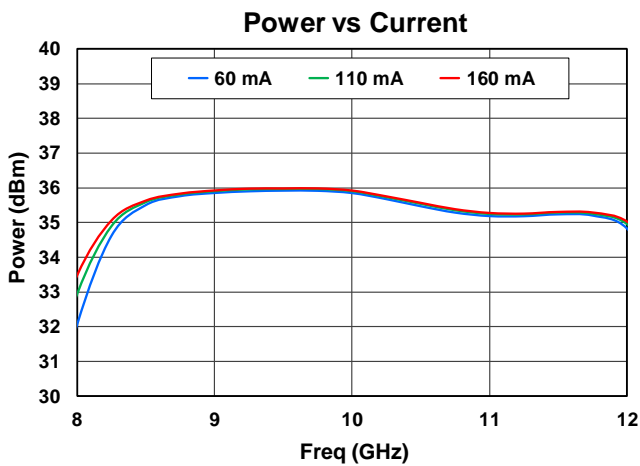
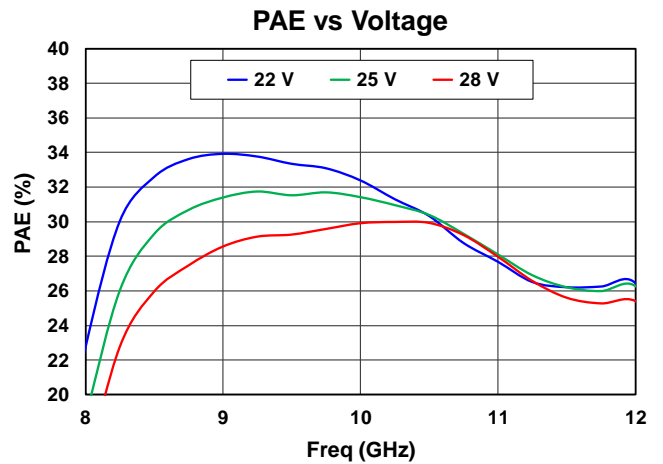
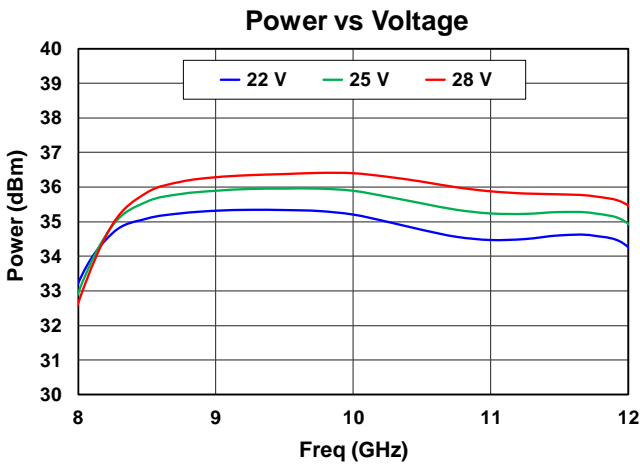
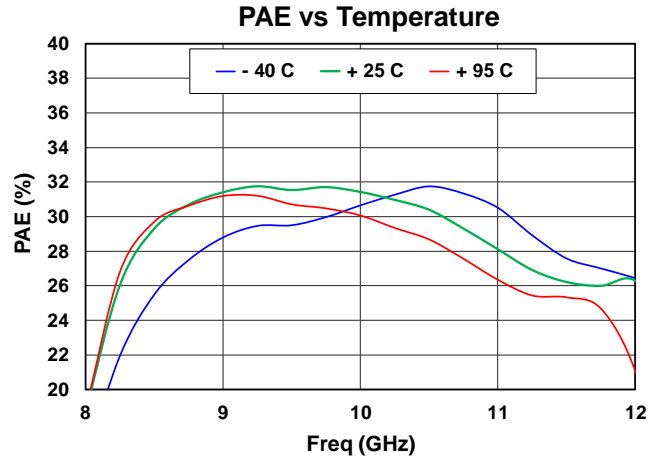
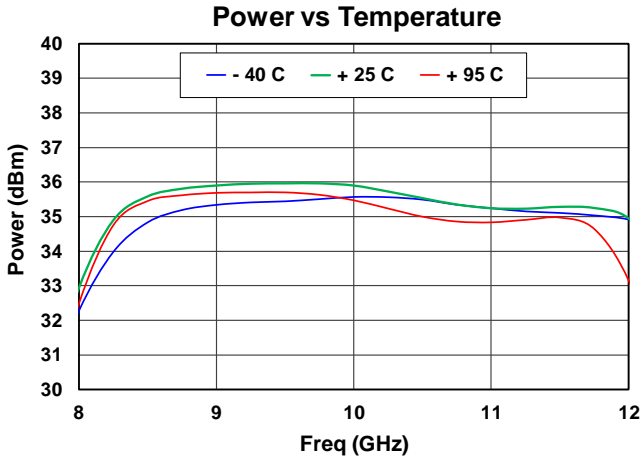

Power Performance, Transmit

Test Conditions unless otherwise stated: TXVD = 25 V, TXIDQ = 110 mA, RXSW = 0V, TXSW = -28 V
Pulse Mode, Pin = 10 dBm, PW = 100 uS, DC = 10%, 25 °C

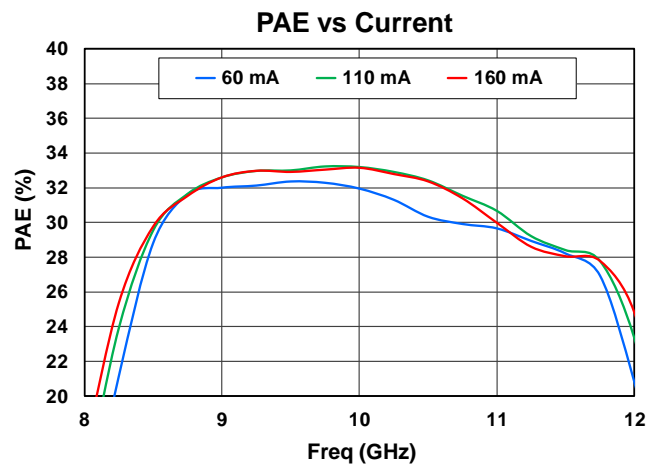
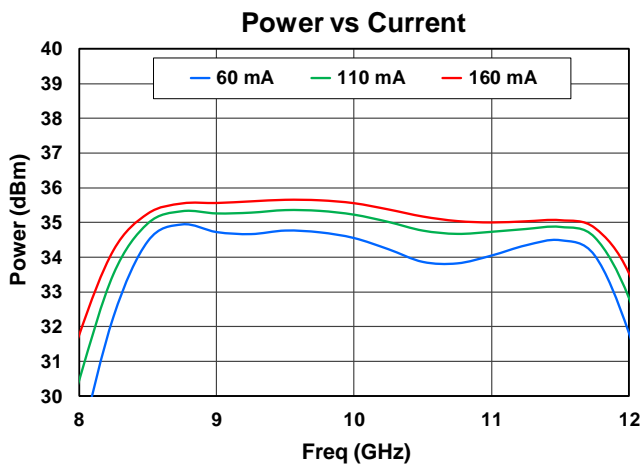
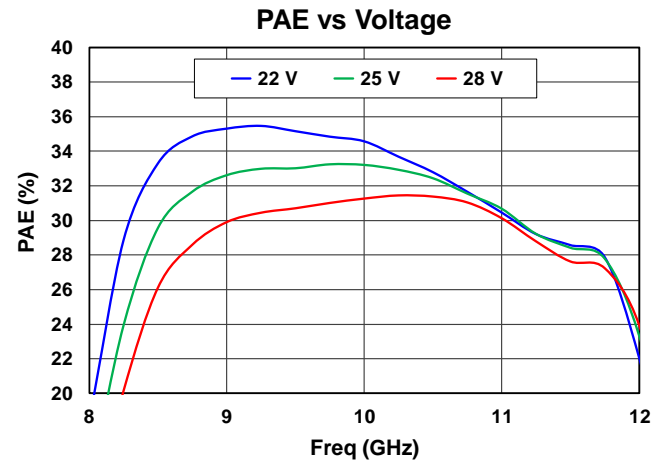
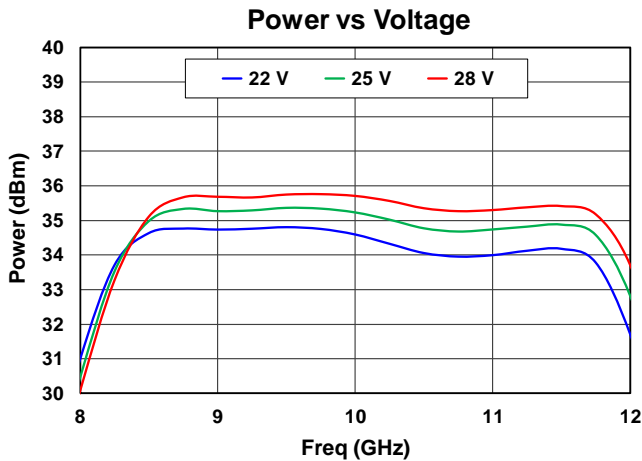
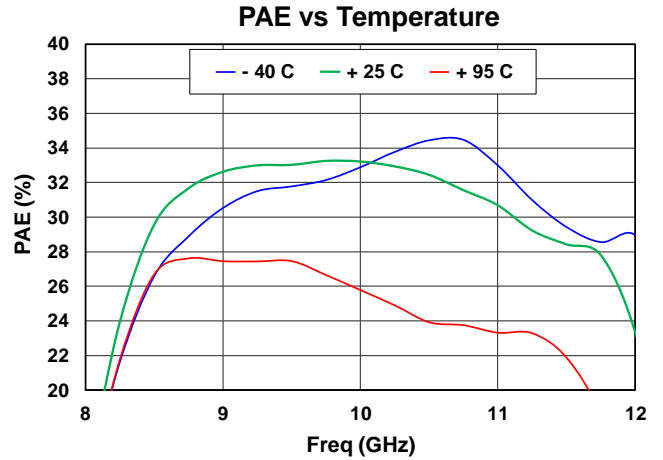
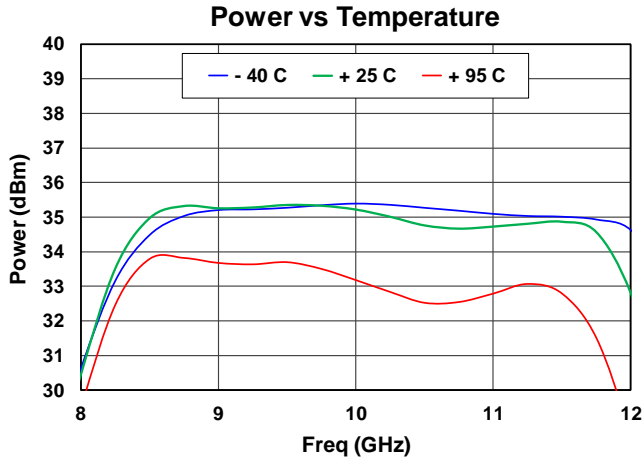

Power Performance, Transmit

Test Conditions unless otherwise stated: TXVD = 25 V, TXIDQ = 110 mA, RXSW = 0V, TXSW = -28 V
Pulse Mode, PW = 100 uS, DC = 10%, 25 °C

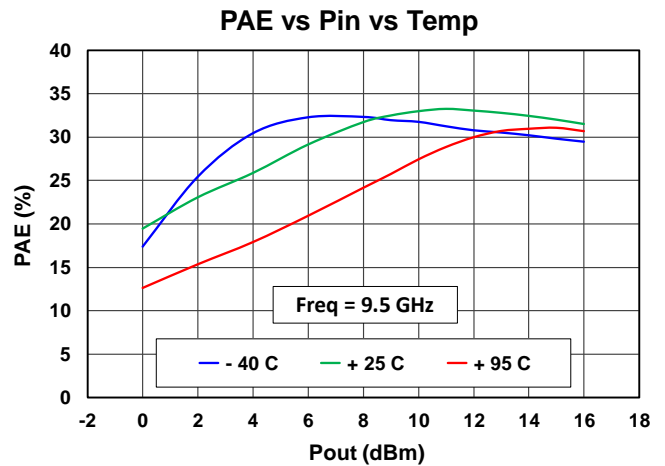
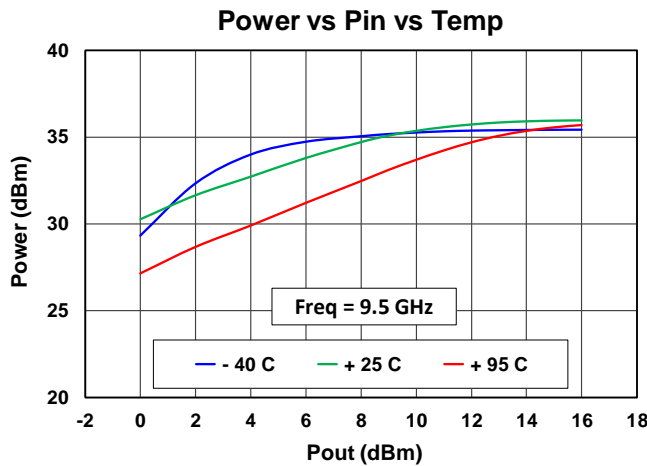
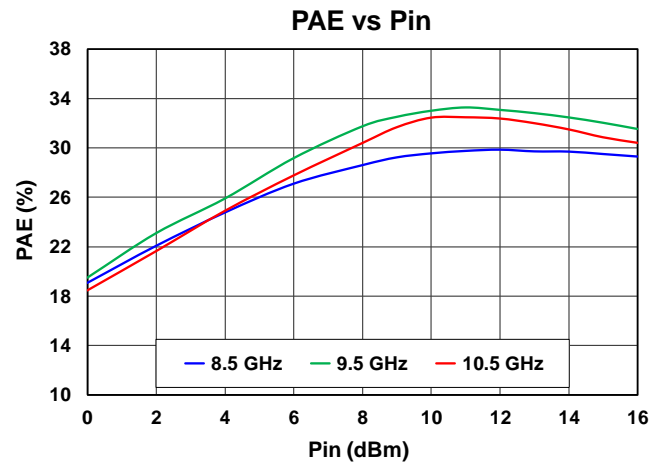
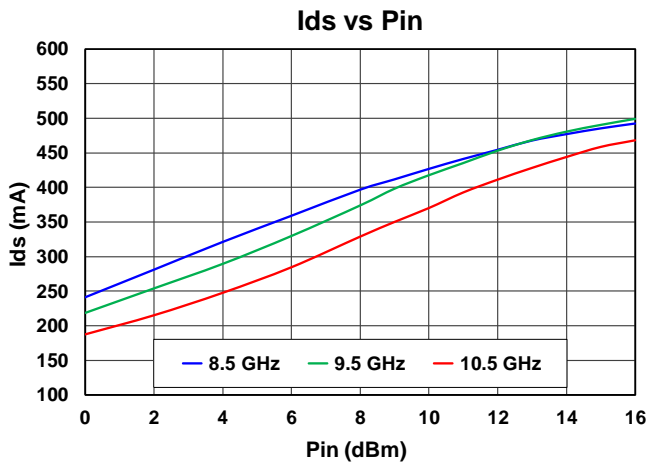
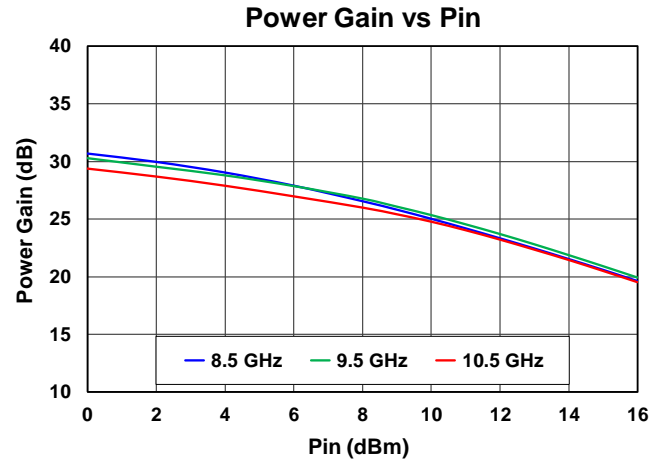
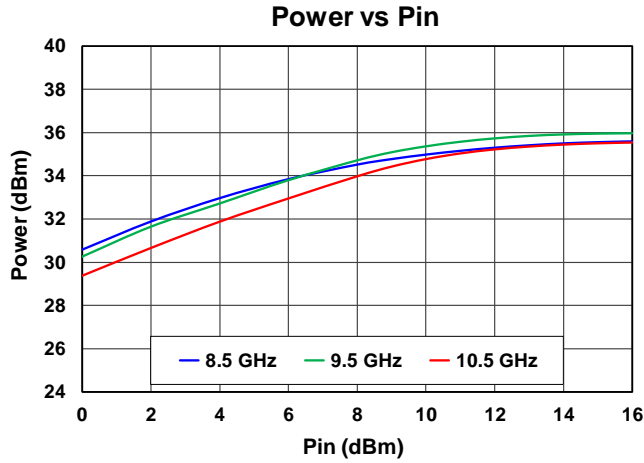

Power Performance, Transmit

Test Conditions unless otherwise stated: TXVD = 25 V, TXIDQ = 110 mA, RXSW = 0V, TXSW = -28 V
Pulse Mode, PW = 100 uS, DC = 10%, 25 °C
Detector Diodes are internally biased, Vout = VREF - VDET

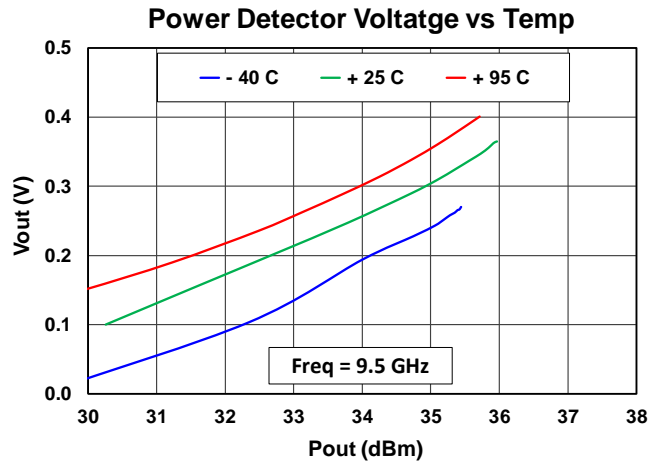
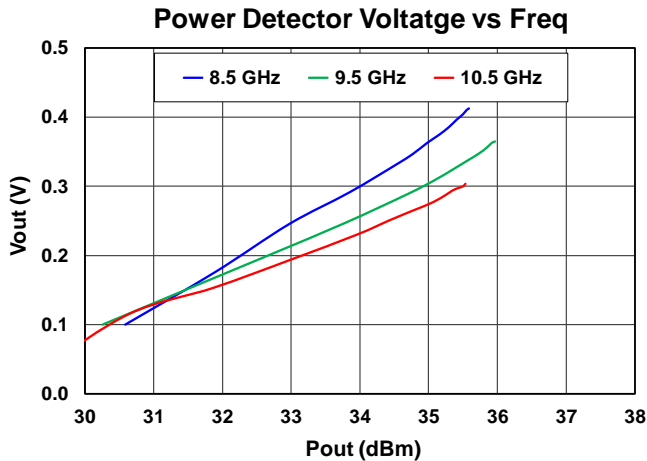
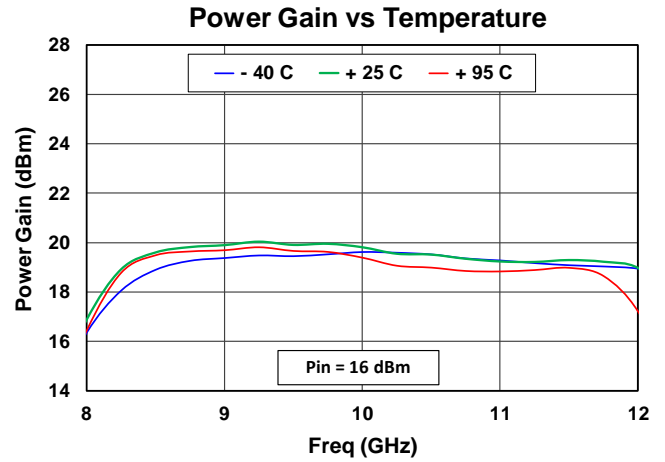
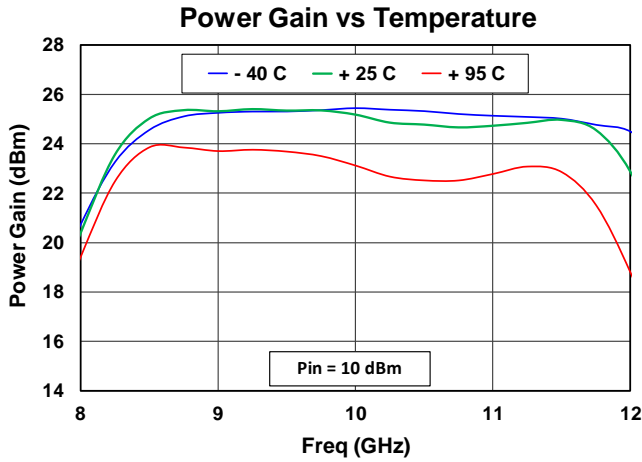

Linearity, Transmit

Test Conditions unless otherwise stated: 25 °C
TXVD = 25 V, TXIDQ = 110 mA, RXSW = 0V, TXSW = -28 V, CW Mode, Tone Spacing = 20 MHz

Output TOI vs Temp

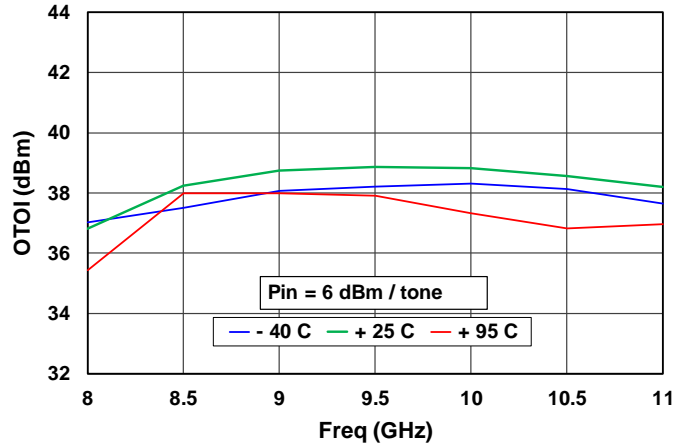

Output TOI vs Voltage

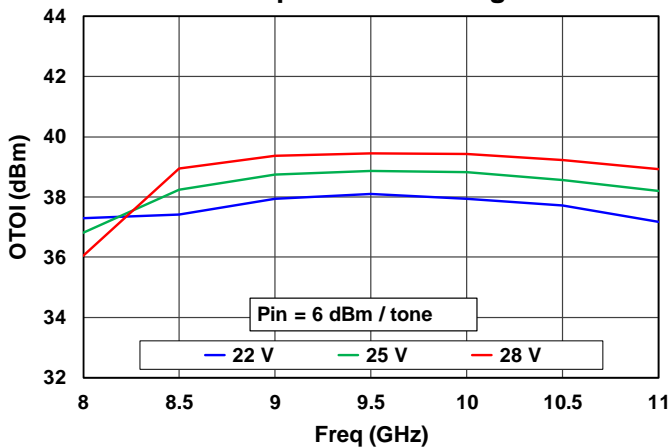

Output TOI vs Current

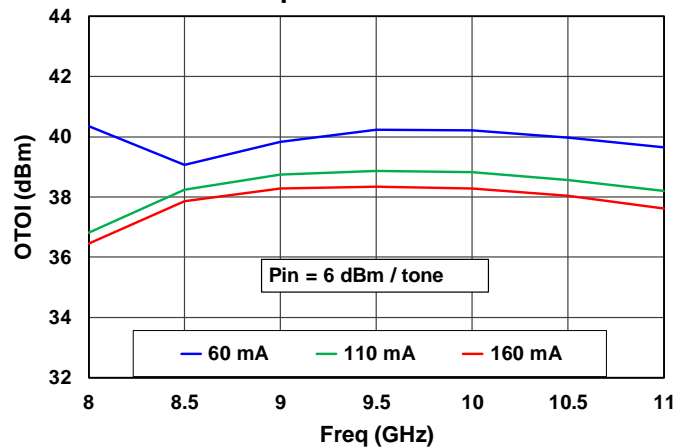

IMD3 vs Pout

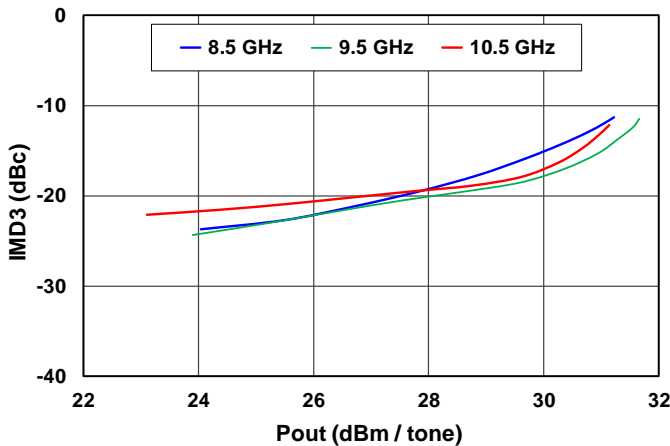

IMD5 vs Pout

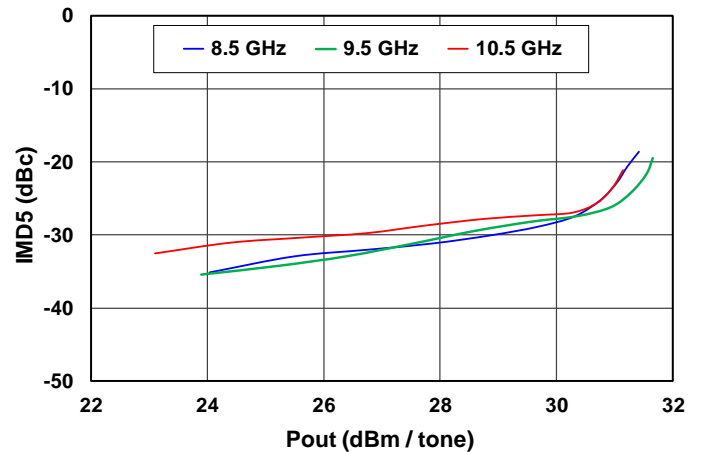

Harmonics, Transmit

Test Conditions unless otherwise stated: TXVD = 25 V, TXIDQ = 110 mA, RXSW = 0V, TXSW = -28 V, CW mode, 25 °C

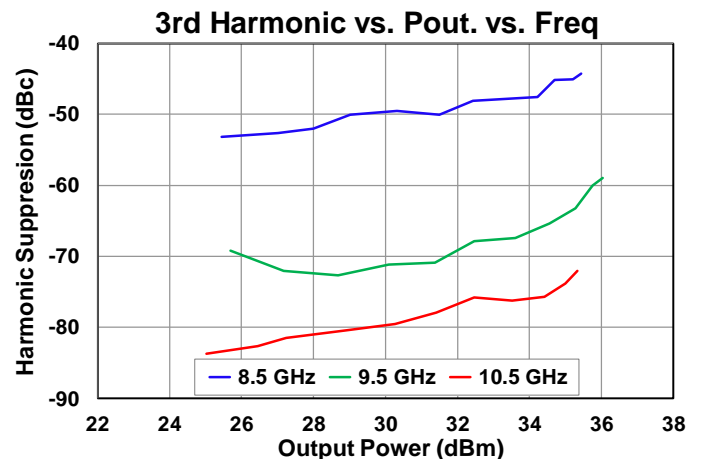
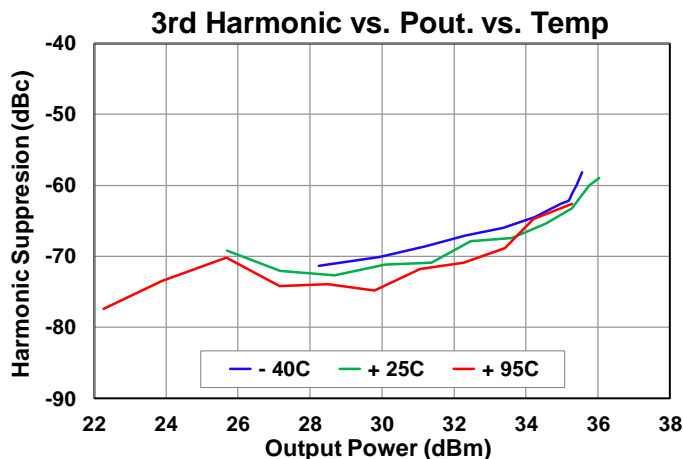
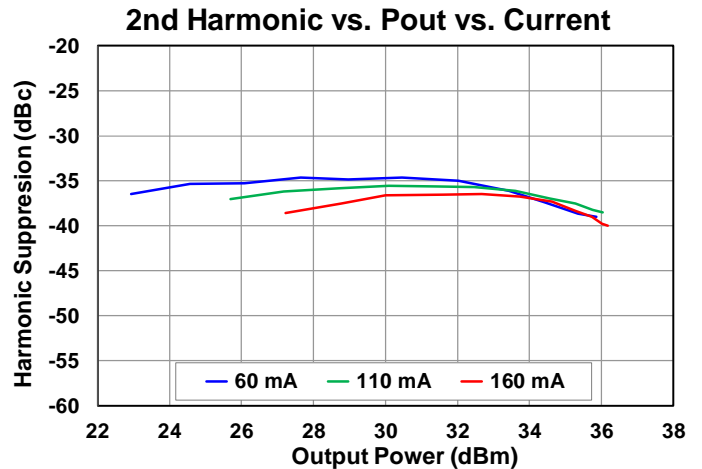
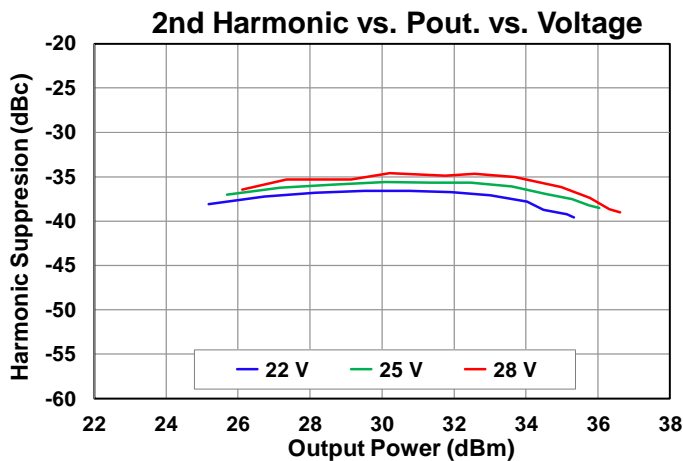
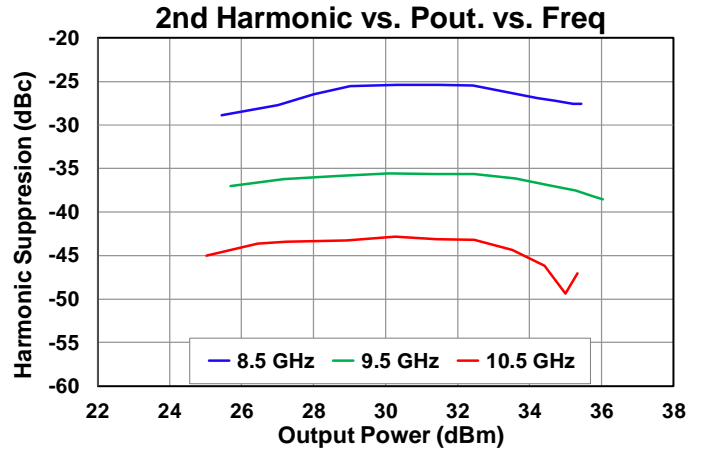
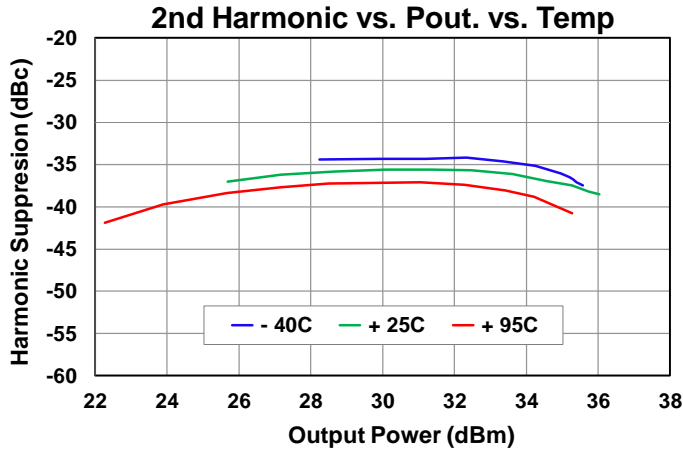

Application Circuit

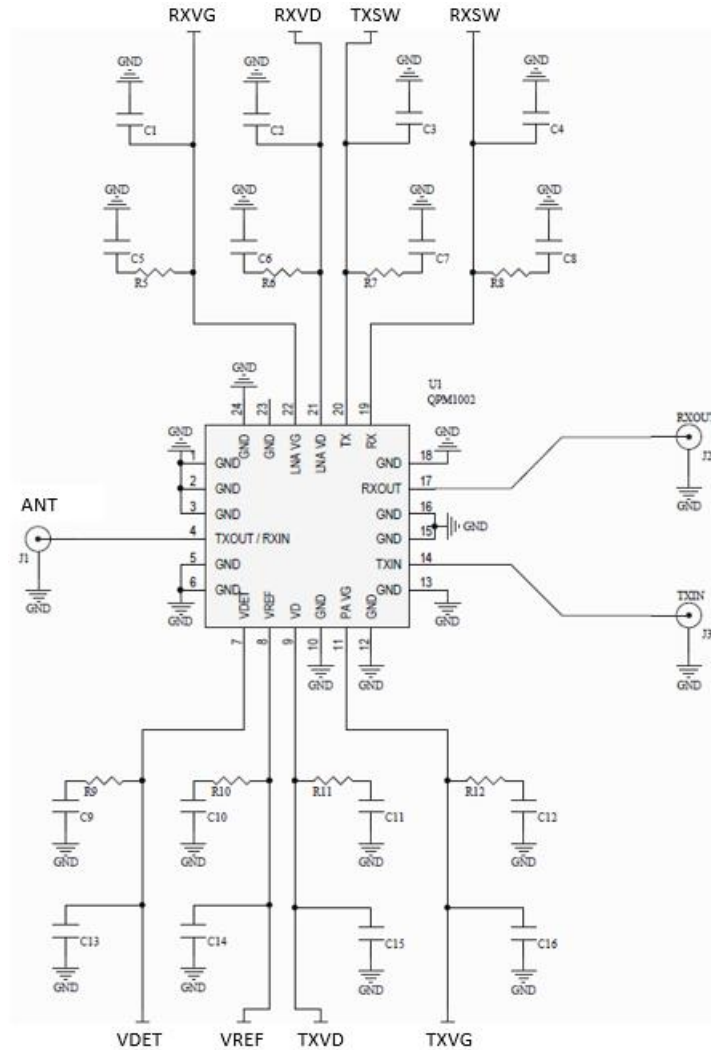

Bias-up Procedure

1. Set TXVD current limit to 600 mA, RXVD current limit to 60mA, gate current limit to 10 mA, switch control current limit to 10mA
2. Set RXVG and TXVG to - 5 V
3. Set TXSW = - 28 V (or 0 V), RXSW = 0 V (or - 28 V) for Transmit (Receive)
4. Set RXVD = + 10 V, TXVD = + 25 V (when in receive mode, should either set TXVG = -5 V, or TXVD off).
5. Adjust TXVG, RXVG to achieve required drain current for TX and RX (-2.5 V Typical)
6. Apply RF signal

Bias-down Procedure

1. Turn off RF signal
2. Set RXVG, TXVG to -5 V
3. Set RXVD = 0 V, TXVD = 0 V
4. Turn off drain supply
5. Turn off TXSW, RXSW
6. Turn off gate supply

Mechanical Drawing & Pad Description

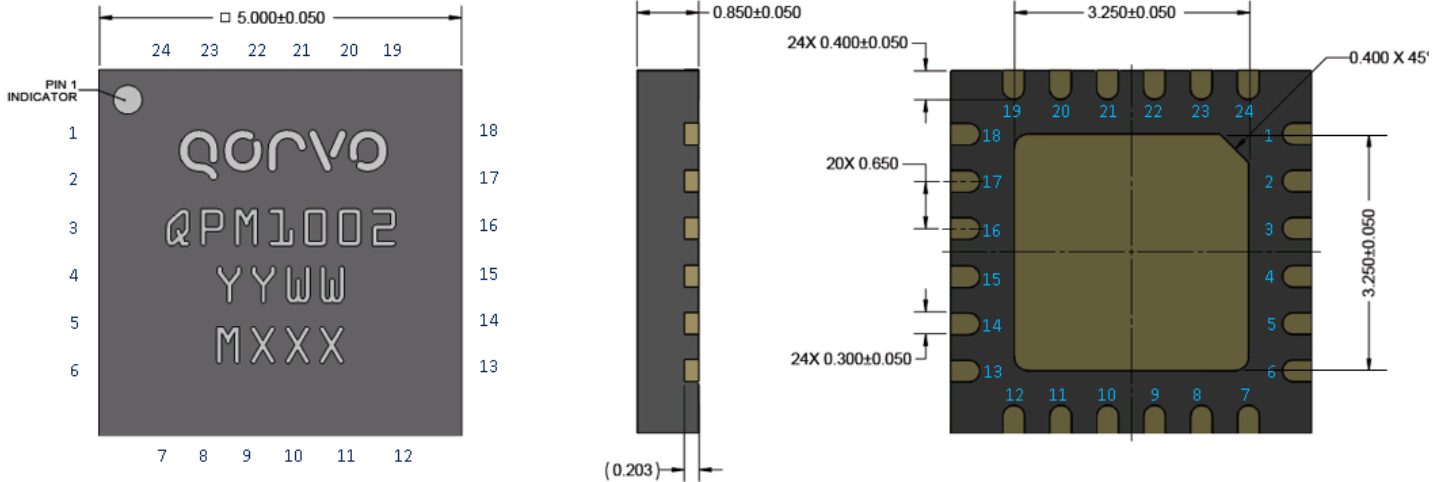

Dimensions in mm, package is mold encapsulated with gold plated leads
 Part Marking: QPM1002 = Part Number
 YY = Part Assembly Year, WW = Part Assembly Week, MXXX = Batch ID

Pin Number	Label	Description
Slug	GND	GROUND
4	ANT	Common Port to Antenna
7	VDET	PA Power Detector
8	VREF	PA Power Detector Reference
9	TXVD	Transmit Drain Supply
11	TXVG	Transmit Gate Control
14	TXIN	Transmit Input
17	RXOUT	Receive Output
19	RXSW	Receive Switch Control
20	TXSW	Transmit Switch Control
21	RXVD	Receive Drain Supply
22	RXVG	Receive Gate Control
1, 2, 3, 5, 6, 10, 12, 13, 15, 16, 18, 23, 24	N/C	No Internal Connections

Evaluation Board and Assembly

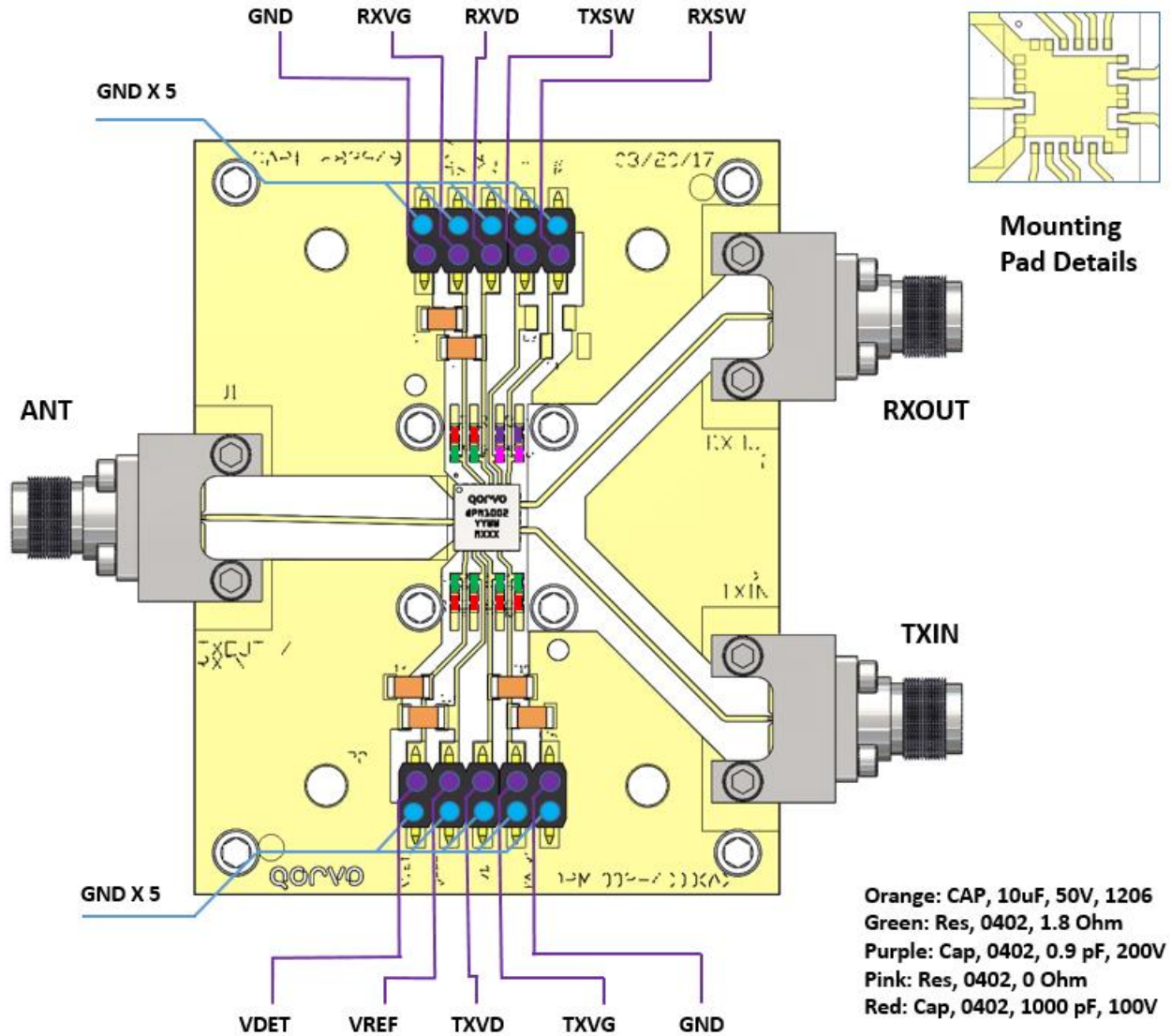

RF Layer is 0.008" thick Rogers Corp. RO4003C ($\epsilon_r = 3.35$). Metal layers are 0.5 oz. copper. The microstrip line at the connector interface is optimized for the Southwest Microwave end launch connector 1092-01A-5.

Ref. Des.	Component	Value	Manuf.	Part Number
C5, C6, C9 - C12	SMT Cap.	CAP, 0402 1000pF +/-10% 100V X7R ROHS	Various	
C1, C2, C13 - C16	SMT Cap.	CAP, 1206 10uF +/-10% 50V X7R	Various	
R5, R6, R9 - R12	SMT Res.	RES, 0402 1.8 OHM, 5% 1/10W	Various	
R7, R8	SMT Res.	RES, 0402 0 OHM, 5% 1/10 W	Various	
C7, C8	SMT Res.	CAP, 0402 0.9 pF, 0.05% 200V, Hi-Q	Various	

Thermal and Reliability Information

Parameter	Values	Units	Conditions
TX Channel, Thermal Resistance (θ_{JC}) ^(1,3)	7.1	°C/W	T _{BASE} = 95°C, TXVD = 25 V, TXIDQ = 110 mA TXID_DRIVE = 482 mA, P _{IN} = 16 dBm, Freq = 9.5 GHz, P _{DISS} = 8.38 W (PA only, LNA off)
Channel Temperature (T _{CH})	154.5	°C	
RX Channel, Thermal Resistance (θ_{JC}) ⁽¹⁾	11.0	°C/W	T _{BASE} = 95°C, RXVD = 10 V, RXIDQ = 20 mA P _{DISS} = 0.2 W (LNA only, PA off)
Channel Temperature (T _{CH})	97.2	°C	

Notes:

1. Thermal resistance is referenced to package backside
2. Base or ambient temperature is 95 °C
3. Transmit Channel, RF drive is under pulse drain supply condition, PW = 100 uS, DC = 10%, P_{DISS} and ID_DRIVE are peak values.
4. Refer to the following document: [GaN Device Channel Temperature, Thermal Resistance, and Reliability Estimates](#)

Solderability and Recommended Soldering Temperature Profile

1. Compatible with the latest version of J-STD-020, Lead-free solder, peak reflow temperature 260 °C.

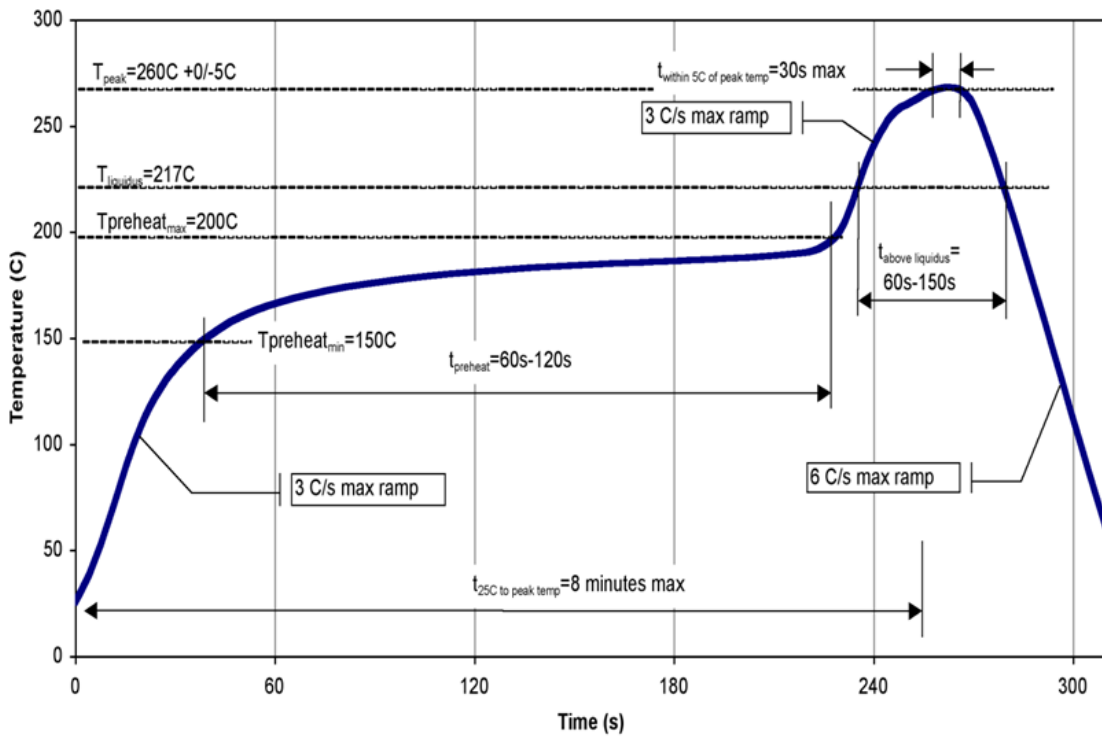

Tape and Reel Information

Standard T/R size = 750 pieces on a 7" reel.

Material		Cavity (mm)				Distance Between Centerline (mm)		Carrier Tape (mm)	Cover Carrier (mm)
Vendor	Vendor P/N	Length (A0)	Width (B0)	Depth (K0)	Pitch (P1)	Length direction (P2)	Width Direction (F)	Width (W)	Width (W)
Advantek	ML0505-A	5.25	5.25	1.1	8.0	2.00	5.50	12.0	9.20

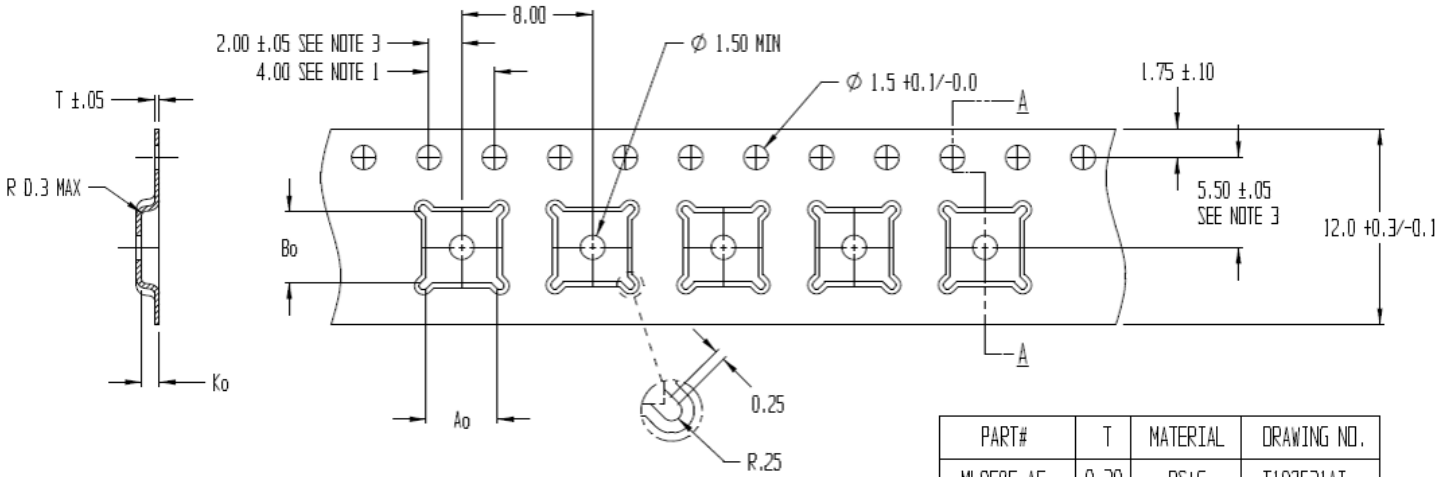

SECTION A - A

A₀ = 5.25
B₀ = 5.25
K₀ = 1.10

PART#	T	MATERIAL	DRAWING NO.
ML0505-AC	0.30	PS+C	T102531AT
ML0505-AD	0.30	PS+C	T108759BT
ML0505-AI	0.25	PS+C	T111798BT

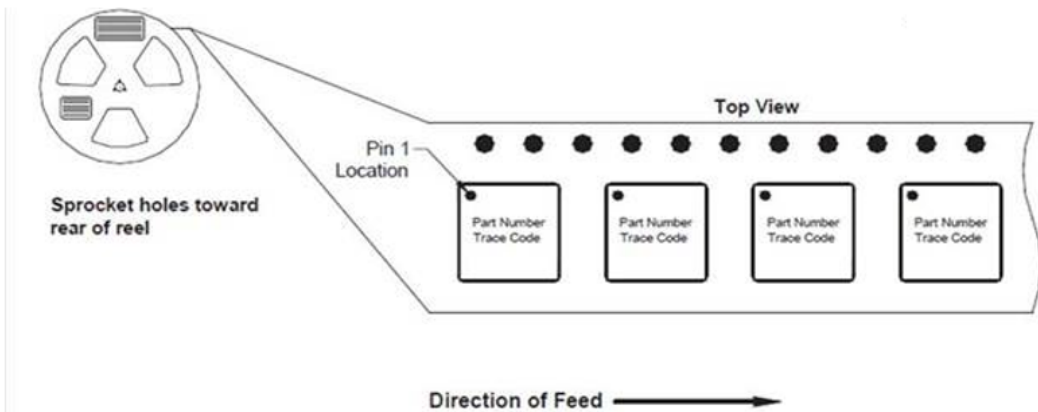

Handling Precautions

Parameter	Rating	Standard
ESD – Human Body Model (HBM)	0Z	ESDA / JEDEC JS-001-2012
ESD – Charged Device Model (CDM)	C3	ESDA / JEDEC JS-002-2014
MSL – Convection Reflow 260 °C	3	JEDEC standard IPC/JEDEC J-STD-020



Caution!
ESD-Sensitive Device

RoHS Compliance

This product is compliant with the 2011/65/EU RoHS directive (Restrictions on the Use of Certain Hazardous Substances in Electrical and Electronic Equipment), as amended by Directive 2015/863/EU.

This product also has the following attributes:

- Lead Free
- Halogen Free (Chlorine, romine)
- Antimony Free
- TBBP-A (C₁₅H₁₂Br₄O₂) Free
- SVHC Free

Contact Information

For the latest specifications, additional product information, worldwide sales and distribution locations:

Tel: 1-844-890-8163

Web: www.qorvo.com

Email: customer.support@qorvo.com

Important Notice

The information contained herein is believed to be reliable; however, Qorvo makes no warranties regarding the information contained herein and assumes no responsibility or liability whatsoever for the use of the information contained herein. All information contained herein is subject to change without notice. Customers should obtain and verify the latest relevant information before placing orders for Qorvo products. The information contained herein or any use of such information does not grant, explicitly or implicitly, to any party any patent rights, licenses, or any other intellectual property rights, whether with regard to such information itself or anything described by such information. **THIS INFORMATION DOES NOT CONSTITUTE A WARRANTY WITH RESPECT TO THE PRODUCTS DESCRIBED HEREIN, AND QORVO HEREBY DISCLAIMS ANY AND ALL WARRANTIES WITH RESPECT TO SUCH PRODUCTS WHETHER EXPRESS OR IMPLIED BY LAW, COURSE OF DEALING, COURSE OF PERFORMANCE, USAGE OF TRADE OR OTHERWISE, INCLUDING THE IMPLIED WARRANTIES OF MERCHANTABILITY AND FITNESS FOR A PARTICULAR PURPOSE.**

Without limiting the generality of the foregoing, Qorvo products are not warranted or authorized for use as critical components in medical, life-saving, or life-sustaining applications, or other applications where a failure would reasonably be expected to cause severe personal injury or death.

Copyright 2020 © Qorvo, Inc. | Qorvo is a registered trademark of Qorvo, Inc.

Компания «Life Electronics» занимается поставками электронных компонентов импортного и отечественного производства от производителей и со складов крупных дистрибьюторов Европы, Америки и Азии.

С конца 2013 года компания активно расширяет линейку поставок компонентов по направлению коаксиальный кабель, кварцевые генераторы и конденсаторы (керамические, пленочные, электролитические), за счёт заключения дистрибьюторских договоров

Мы предлагаем:

- Конкурентоспособные цены и скидки постоянным клиентам.
- Специальные условия для постоянных клиентов.
- Подбор аналогов.
- Поставку компонентов в любых объемах, удовлетворяющих вашим потребностям.
- Приемлемые сроки поставки, возможна ускоренная поставка.
- Доставку товара в любую точку России и стран СНГ.
- Комплексную поставку.
- Работу по проектам и поставку образцов.
- Формирование склада под заказчика.
- Сертификаты соответствия на поставляемую продукцию (по желанию клиента).
- Тестирование поставляемой продукции.
- Поставку компонентов, требующих военную и космическую приемку.
- Входной контроль качества.
- Наличие сертификата ISO.

В составе нашей компании организован Конструкторский отдел, призванный помогать разработчикам, и инженерам.

Конструкторский отдел помогает осуществить:

- Регистрацию проекта у производителя компонентов.
- Техническую поддержку проекта.
- Защиту от снятия компонента с производства.
- Оценку стоимости проекта по компонентам.
- Изготовление тестовой платы монтаж и пусконаладочные работы.



Тел: +7 (812) 336 43 04 (многоканальный)

Email: org@lifeelectronics.ru