

LCM600

600 Watts

Bulk Front End

Total Power: 600 W
of Outputs: Single
Output: 3.3 to 60 V
Optional 5.0 V standby



Special Features

- 600 W output power
- Low Cost
- 2.4" x 4.5" x 7.5"
- 7.41 W/cu-in
- Industrial/Medical safety
- -40 °C to 70 °C with derating
- Optional 5 V @ 2 A Housekeeping
- High Efficiency: 89% typical
- Variable speed "Smart Fans"
- DSP controlled front end
- Conformal coat option
- ± 20% adjustment range
- Margin programming
- OR-ing FET
- Terminal block input option

Compliance

- EMI Class B
- EN61000 Immunity

Safety

- UL 60950-1
508/1598/1433
60601-1
- CSA 60950-1
- VDE 60950-1
60601
- China CCC
- CB Scheme Report/Cert

Electrical Specifications

Input	
Input range:	85 - 264 Vac (Operating) 115/230 Vac (Nominal) Input through standard IEC connector
Frequency:	47 - 440 Hz, Nominal 50/60
Input fusing:	Internal 10 A fuses, both lines fused
Inrush current:	≤ 25 A peak, either hot or cold start
Power factor:	0.99 typical, meets EN61000-3-2
Harmonics:	Meets IEC 1000-3-2 requirements
Input current:	8 A RMS max input current, at 100 Vac
Hold up time:	20 ms minimum for Main O/P, at full rated load
Efficiency:	> 88% at full load
Leakage current:	< 0.3 mA at 264 Vac
ON/OFF power switch:	N/A
Power line transient:	MOV directly after the fuse
Isolation:	PRI-Chassis 2500 Vdc Basic PRI-SEC 2500 Vdc Reinforced SEC-Chassis 500 Vdc

LCM600Q Efficiency Without the 5 Vsb and 24 V ORing FETS

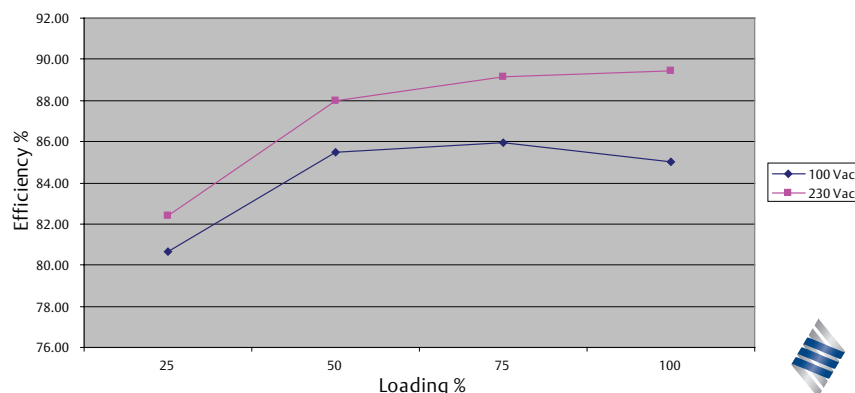

Output		
Output rating:	See table 1	85 - 264 Vac
Set point:	± 0.5%	85 - 264 Vac
Total regulation range:	Main output ± 2% 5 Vsb ± 1%	Combined line/load/transient when measured at output terminal
Rated load:	600 W maximum	Derate linear to 50% from 50 °C to 70 °C
Minimum load:	Main output @ 0.0 A 5 Vsb @ 0.0 A	No loss of regulation
Output noise (PARD):	1% max p-p 50 mV max p-p	Main output 5 Vsb output Measured with a 0.1 µF Ceramic and 10 µF Tantalum Capacitor on any output, 20 MHz
Output voltage overshoot:		No overshoot/undershoot outside the regulation band during on or off cycle
Transient response:	< 300 µSec	50% load step @ 1 A/µs Step load valid between 10% to 100% of output rating Recovery time to within 1% of set point at onset of transient
Max units in parallel:		Up to 10
Short circuit protection:	Protected, no damage to occur	Bounce mode
Remote sense:		Compensation up to 500 mV
Output isolation:		Standard per safety requirements
Forced load sharing:	To within 10% of all shared outputs	Analog sharing control
Overload protection (OCP):	105% to 125% 120% to 170%	Main output 5 Vsb output
Overvoltage protection (OVP):	125% to 145% 110% to 125%	12 V output 5 Vsb output
Overtemp protection:	10 - 15 °C above safe operating area	Both PFC and output converter monitored

Environmental Specifications

Operating temperature:	-40 °C to +70 °C, linear derating to 50% from 50 °C to 70 °C
Storage temperature:	-40 °C to +85 °C
Humidity:	20 to 90%, non-condensing. Operating. Conformal coat option available
Fan noise:	< 45 dBA, 80% load at 30 °C
Altitude:	Operating - 15,000 feet Storage - 30,000 feet
Shock:	MIL-STD-810F 516.5, Procedure I, VI. Storage
Vibration:	MIL-STD-810F 514.5, Cat. 4, 10. Storage

Ordering Information

Model Number*	Output	Nominal Output Voltage Set Point	Set Point Tolerance	Adjustment Range	Current		Output Ripple P/P	Power Max.	Combined Line/ Load Regulation	Status
					Min	Max				
LCM600C	3 V	3 V	± 0.5%	2.0 - 4.0 V	0 A	150 A	50 mV	600 W	2%	Coming Soon
LCM600E	5 V	5 V	± 0.5%	4.0 - 6.0 V	0 A	120 A	50 mV	600 W	2%	Coming Soon
LCM600L	12 V	12 V	± 0.5%	9.6 - 14.4 V	0 A	52 A	120 mV	600 W	2%	Released
LCM600N	15 V	15 V	± 0.5%	12.0 - 19.5 V	0 A	44 A	150 mV	600 W	2%	Coming Soon
LCM600Q	24 V	24 V	± 0.5%	19.2 - 28.8 V	0 A	27 A	240 mV	600 W	2%	Released
LCM600U	36 V	36 V	± 0.5%	28.8 - 43.2 V	0 A	16.7 A	240 mV	600 W	2%	Released
LCM600W	48 V	48 V	± 0.5%	38.4 - 57.6 V	0 A	14 A	280 mV	600 W	2%	Released

*Note: Add "-T" for terminal block instead of IEC input.

Pin Assignment		
Signals	Name Description	Pin Number(s)
+Vout	Power rail	SK4
GND	Power GND	SK5
Signals	Name Description	SK2 Pin Number
A2	EEPROM Address	1
-VPROG	Return connection of external supply for Margin Programming	2
A1	EEPROM Address	3
-Vsense	Remote Sense Return	4
ISHARE	Load share voltage	5
A0	EEPROM Address	6
SDA1	Serial Data Signal (I2C)	7
+VPROG	Positive connection of external supply for Margin Programming	8
SCL1	Serial Clock Signal (I2C)	9
+Vsense	Remote Sense Positive	10
5VSB	5V standby	11
GND	5V standby Return	12
5VSB	5V standby	13
G_DCOK_C	Global DCOK Collector	14
GPIOA6	EEPROM Write Protect	15
G_DCOK_E	Global DCOK Emitter (GND)	16
GND	Return Ground for output signal and I2C communication	17
G_ACOK_C	Global ACOK Collector	18
INH_EN	Turn Off Main Output	19
G_ACOK_E	Global ACOK Emitter (GND)	20

Note: Mating connector for SK2 is LANDWIN CI0120P1HD0-LF

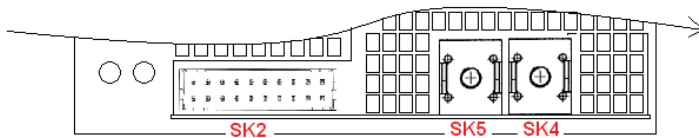

PSU Front View

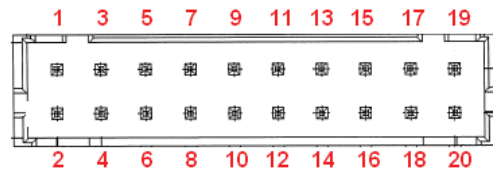

Signal Output Signal Connectors (SK2)

LED Indicators

2 provided are clearly visible up to a 45 degree offset from vertical with office environment ambient lighting. The status is reflected in the indicator color.

The DC_OK LED is bicolor. It shall light green if the DC output is within specification, and amber if the output falls out of specification.

The AC_OK LED is Green if the AC is within specification and off when out of specification. Note: With 5 V standby, Amber also indicates that PSU is in standby mode/output off.

Control Signals

AC_OK Open collector 0.5 V maximum at 10 mA. Both emitter and collector access provided.

DC_OK Open collector 0.5 V maximum at 10 mA. Both emitter and collector access provided.

PS_INHIBIT/ENABLE Signal 0.0 - 0.5 V contact closure, output OFF

Mechanical Drawing - Terminal Block Input Weight: 2.84 lbs (1.29 Kg)

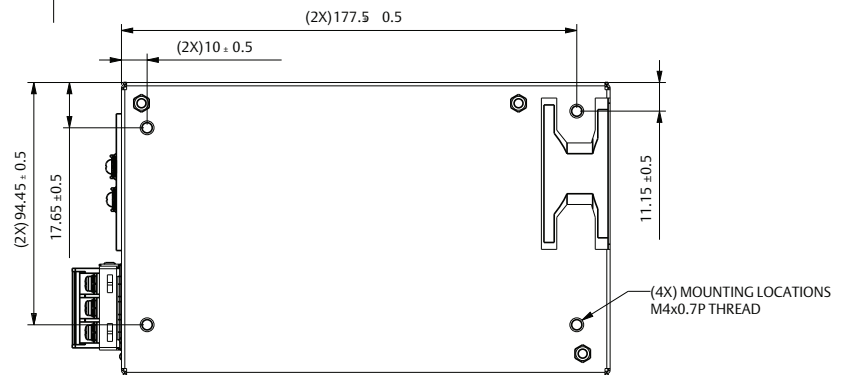
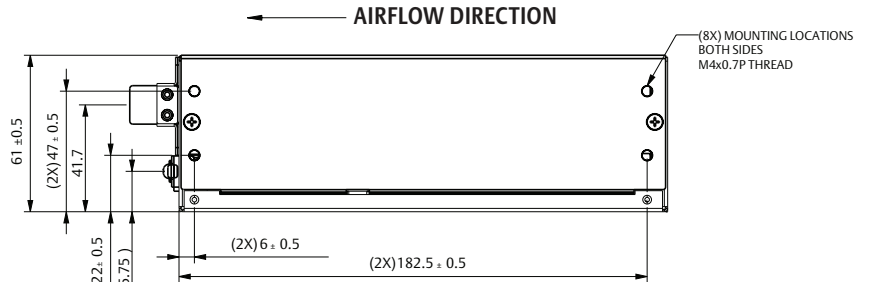
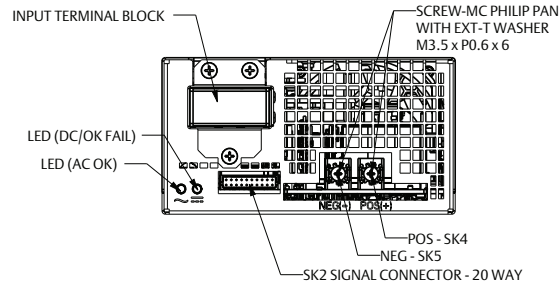
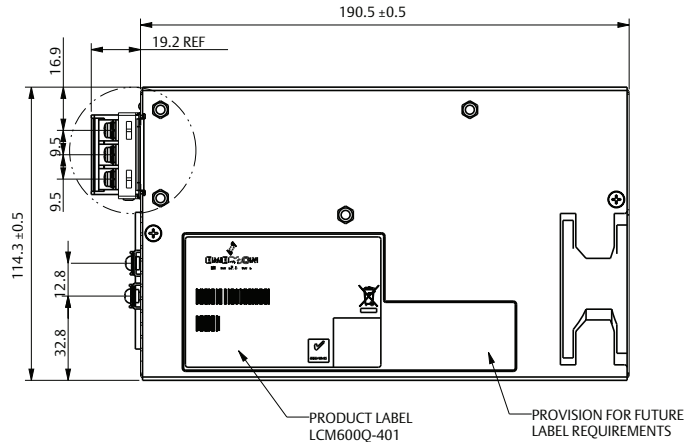

Accessories



Order kit part number 73-788-001 for control connector interface with .3m wires attached



Order kit part number 73-788-002 for control connector interface with unloaded housing and 20 pins

Miscellaneous Specifications

Burn-In

100% Burn-in at 45 °C, at 80 - 90 % load. Duration of burn-in determined by Quality Assurance Procedures

MTBF

The power supply has a minimum MTBF of 300K hours using the Bell core 332, issue 6 specification @ 25 °C and 40 °C, ambient, at full load. With the power supply installed in a system in a 25 °C ambient environment and operating at full load, capacitor life shall be 10 years, minimum for ALL electrolytic capacitors contained within this power supply. The power supply shall demonstrate a MTBF level of > 500,000 hours.

Quality Assurance

Full QAV testing shall be conducted in accordance with Emerson Network Power Standards with reports available upon request.

Warranty

Emerson Network Power shall warrant the power supply to be free of defects in materials and workmanship for a minimum period of **three years** from the date of shipment, when operated within specifications. The warranty shall be fully transferable to the end owner of the equipment powered by the supply.

Americas

5810 Van Allen Way
Carlsbad, CA 92008
USA
Telephone: +1 760 930 4600
Facsimile: +1 760 930 0698

Europe (UK)

Waterfront Business Park
Merry Hill, Dudley
West Midlands, DY5 1LX
United Kingdom
Telephone: +44 (0) 1384 842 211
Facsimile: +44 (0) 1384 843 355

Asia (HK)

14/F, Lu Plaza
2 Wing Yip Street
Kwun Tong, Kowloon
Hong Kong
Telephone: +852 2176 3333
Facsimile: +852 2176 3888

For global contact, visit:

www.Emerson.com/EmbeddedPower
techsupport.embeddedpower@emerson.com

While every precaution has been taken to ensure accuracy and completeness in this literature, Emerson Network Power assumes no responsibility, and disclaims all liability for damages resulting from use of this information or for any errors or omissions.

Emerson Network Power.

The global leader in enabling business-critical continuity.

- AC Power
- Connectivity
- DC Power
- Embedded Computing
- **Embedded Power**
- Monitoring
- Outside Plant
- Power Switching & Controls
- Precision Cooling
- Racks & Integrated Cabinets
- Services
- Surge Protection

EmersonNetworkPower.com

Emerson Network Power and the Emerson Network Power logo are trademarks and service marks of Emerson Electric Co.
©2011 Emerson Electric Co.

Компания «Life Electronics» занимается поставками электронных компонентов импортного и отечественного производства от производителей и со складов крупных дистрибьюторов Европы, Америки и Азии.

С конца 2013 года компания активно расширяет линейку поставок компонентов по направлению коаксиальный кабель, кварцевые генераторы и конденсаторы (керамические, пленочные, электролитические), за счёт заключения дистрибьюторских договоров

Мы предлагаем:

- Конкурентоспособные цены и скидки постоянным клиентам.
- Специальные условия для постоянных клиентов.
- Подбор аналогов.
- Поставку компонентов в любых объемах, удовлетворяющих вашим потребностям.
- Приемлемые сроки поставки, возможна ускоренная поставка.
- Доставку товара в любую точку России и стран СНГ.
- Комплексную поставку.
- Работу по проектам и поставку образцов.
- Формирование склада под заказчика.
- Сертификаты соответствия на поставляемую продукцию (по желанию клиента).
- Тестирование поставляемой продукции.
- Поставку компонентов, требующих военную и космическую приемку.
- Входной контроль качества.
- Наличие сертификата ISO.

В составе нашей компании организован Конструкторский отдел, призванный помогать разработчикам, и инженерам.

Конструкторский отдел помогает осуществить:

- Регистрацию проекта у производителя компонентов.
- Техническую поддержку проекта.
- Защиту от снятия компонента с производства.
- Оценку стоимости проекта по компонентам.
- Изготовление тестовой платы монтаж и пусконаладочные работы.



Тел: +7 (812) 336 43 04 (многоканальный)

Email: org@lifeelectronics.ru