

## 100A BIDIRECTIONAL SURFACE MOUNT THYRISTOR SURGE PROTECTIVE DEVICE

### Features

- 100A Peak Pulse Current @ 10/1000 $\mu$ s
- 400A Peak Pulse Current @ 8/20 $\mu$ s
- 58 - 320V Stand-Off Voltages
- Oxide-Glass Passivated Junction
- Bidirectional Protection In a Single Device
- High Off-State Impedance and Low On-State Voltage
- Helps Equipment Meet GR-1089-CORE, IEC 61000-4-5, FCC Part 68, ITU-T K.20/K.21, and UL497B
- UL Listed Under Recognized Component Index, File Number 156346
- **Lead Free Finish/RoHS Compliant (Note 1)**
- **Green Molding Compound (No Halogen and Antimony) (Note 2)**

### Mechanical Data

- Case: SMB
- Case Material: Molded Plastic. UL Flammability Classification Rating 94V-0
- Moisture Sensitivity: Level 1 per J-STD-020
- Terminals: Lead Free Plating (Matte Tin Finish). Solderable per MIL-STD-202, Method 208
- Polarity: None; Bidirectional Devices Have No Polarity Indicator
- Weight: 0.093 grams (approximate)



Top View



Bottom View

### Ordering Information (Note 3)

Part Number	Case	Packaging
TB0640H-13-F	SMB	3000/Tape & Reel
TB0720H-13-F	SMB	3000/Tape & Reel
TB0900H-13-F	SMB	3000/Tape & Reel
TB1100H-13-F	SMB	3000/Tape & Reel
TB1300H-13-F	SMB	3000/Tape & Reel
TB1500H-13-F	SMB	3000/Tape & Reel
TB1800H-13-F	SMB	3000/Tape & Reel
TB2300H-13-F	SMB	3000/Tape & Reel
TB2600H-13-F	SMB	3000/Tape & Reel
TB3100H-13-F	SMB	3000/Tape & Reel
TB3500H-13-F	SMB	3000/Tape & Reel

- Notes:
1. EU Directive 2002/95/EC (RoHS). All applicable RoHS exemptions applied, see EU Directive 2002/95/EC Annex Notes.
  2. Product manufactured with Data Code 0924 (week 24, 2009) and newer are built with Green Molding Compound.
  3. For packaging details, go to our website at <http://www.diodes.com>.

### Marking Information

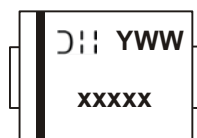

- xxxxx = Product type marking code (See table on page 2)
- DII = Manufacturers' code marking
- YWW = Date code marking
- Y = Last digit of year (ex: 6 for 2006)
- WW = Week code (01 to 53)

### Maximum Ratings @ $T_A = 25^\circ\text{C}$ unless otherwise specified

Single phase, half wave, 60Hz, resistive or inductive load.  
 For capacitance load, derate current by 20%.

Characteristic	Symbol	Value	Unit
Non-Repetitive Peak Impulse Current @10/1000us	$I_{pp}$	100	A
Non-Repetitive Peak On-State Current @8.3ms (one-half cycle)	$I_{TSM}$	50	A
Typical Positive Temperature Coefficient for Breakdown Voltage	$\Delta V_{BR}/\Delta T_J$	0.1	%/°C

### Thermal Characteristics

Characteristic	Symbol	Value	Unit
Thermal Resistance, Junction to Lead	$R_{\theta JL}$	20	°C/W
Thermal Resistance, Junction to Ambient	$R_{\theta JA}$	100	°C/W
Junction Temperature Range	$T_J$	-40 to +150	°C
Storage Temperature Range	$T_{STG}$	-55 to +150	°C

### Maximum Rated Surge Waveform

Waveform	Standard	$I_{pp}$ (A)
2/10 $\mu\text{s}$	GR-1089-CORE	500
8/20 $\mu\text{s}$	IEC 61000-4-5	400
10/160 $\mu\text{s}$	FCC Part 68	250
10/700 $\mu\text{s}$ (Note 4)	ITU-T, K.20/K.21	200
10/560 $\mu\text{s}$	FCC Part 68	160
10/1000 $\mu\text{s}$	GR-1089-CORE	100

Notes: 4. Applied 6kV, 10/700 $\mu\text{s}$  waveform

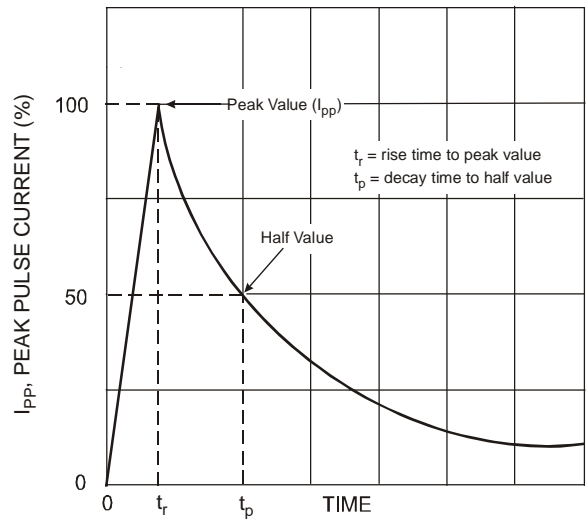

**Electrical Characteristics** @ $T_A = 25^\circ\text{C}$  unless otherwise specified

Part Number	Maximum Rated Repetitive Off-State Voltage	Maximum Off-State Leakage Current @ $V_{\text{DRM}}$	Maximum Breakover Voltage	Maximum On-State Voltage @ $I_T = 1\text{A}$	Breakover Current $I_{\text{BO}}$		Holding Current $I_{\text{H}}$		Typical Off-State Capacitance	Marking Code
	$V_{\text{DRM}}$ (V)	$I_{\text{DRM}}$ ( $\mu\text{A}$ )	$V_{\text{BO}}$ (V)	$V_{\text{T}}$ (V)	Min (mA)	Max (mA)	Min (mA)	Max (mA)	$C_{\text{O}}$ (pF)	
TB0640H	58	5	77	3.5	50	800	150	800	200	T064H
TB0720H	65	5	88	3.5	50	800	150	800	200	T072H
TB0900H	75	5	98	3.5	50	800	150	800	200	T090H
TB1100H	90	5	130	3.5	50	800	150	800	120	T110H
TB1300H	120	5	160	3.5	50	800	150	800	120	T130H
TB1500H	140	5	180	3.5	50	800	150	800	120	T150H
TB1800H	160	5	220	3.5	50	800	150	800	120	T180H
TB2300H	190	5	265	3.5	50	800	150	800	80	T230H
TB2600H	220	5	300	3.5	50	800	150	800	80	T260H
TB3100H	275	5	350	3.5	50	800	150	800	80	T310H
TB3500H	320	5	400	3.5	50	800	150	800	80	T350H

Symbol	Parameter
$V_{\text{DRM}}$	Stand-off Voltage
$I_{\text{DRM}}$	Leakage current at stand-off voltage
$V_{\text{BR}}$	Breakdown voltage
$I_{\text{BR}}$	Breakdown current
$V_{\text{BO}}$	Breakover voltage
$I_{\text{BO}}$	Breakover current
$I_{\text{H}}$	Holding current (Note 5)
$V_{\text{T}}$	On state voltage
$I_{\text{PP}}$	Peak pulse current
$C_{\text{O}}$	Off-state capacitance (Note 6)

- Notes:
- $I_{\text{H}} > (V_{\text{L}}/R_{\text{L}})$  If this criterion is not obeyed, the TSPD triggers but does not return correctly to high-resistance state. The surge recovery time does not exceed 30ms.
  - Off-state capacitance measured at  $f = 1.0\text{MHz}$ ,  $1.0V_{\text{RMS}}$  signal,  $V_{\text{R}} = 2V_{\text{DC}}$  bias.

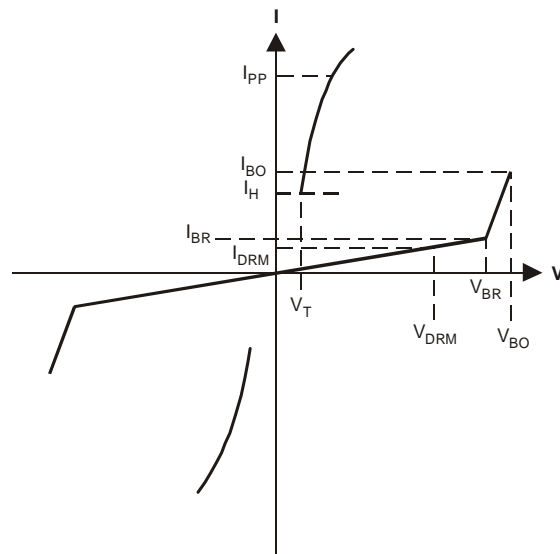

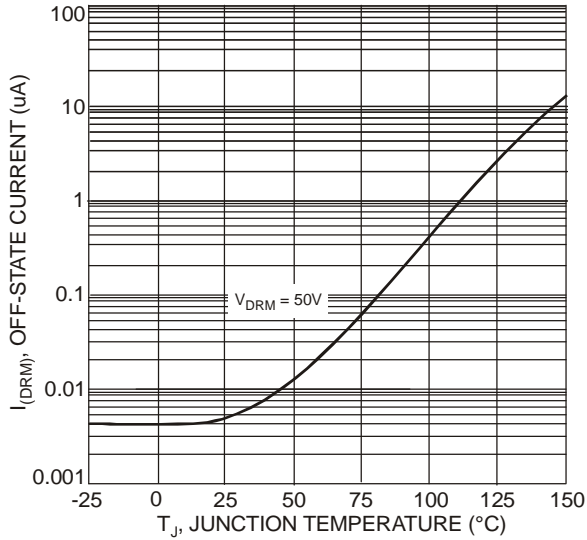

Fig. 1 Off-State Current vs. Junction Temperature

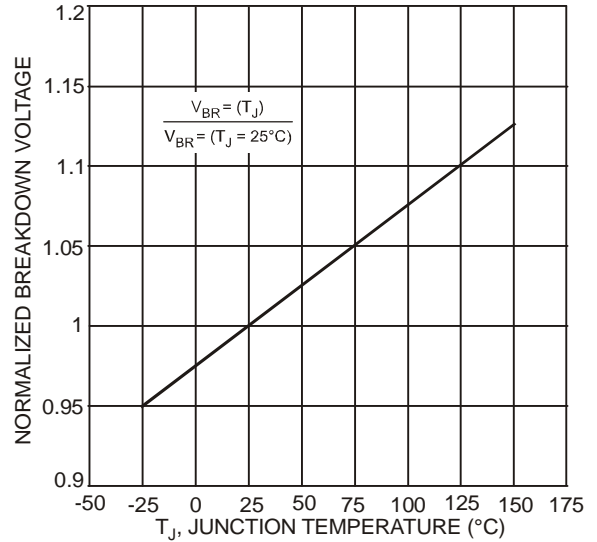

Fig. 2 Relative Variation of Breakdown Voltage vs. Junction Temperature

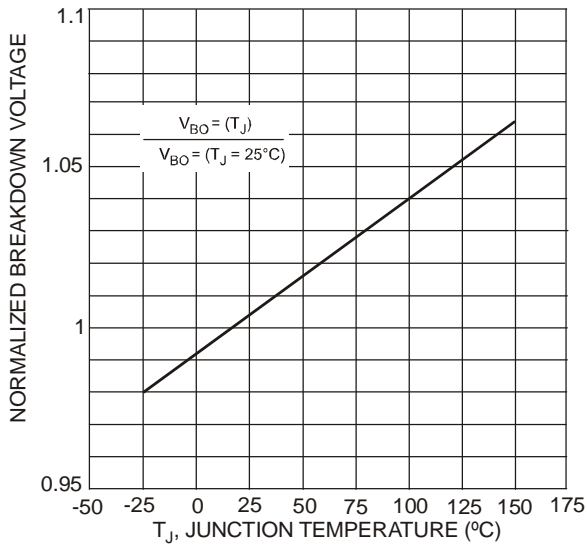

Fig. 3 Relative Variation of Breakover Voltage vs. Junction Temperature

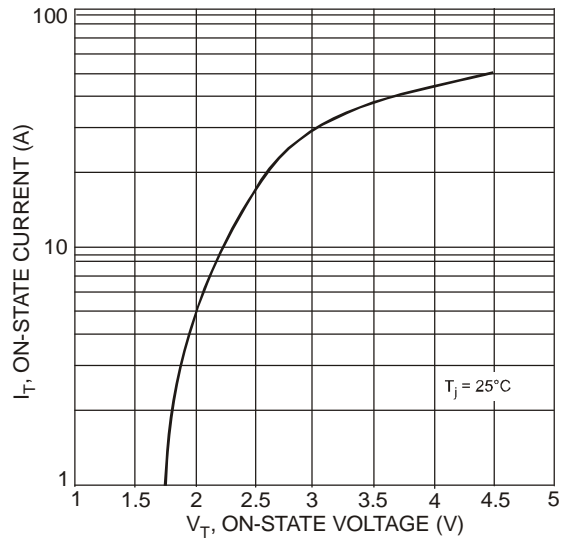

Fig. 4 On-State Current vs. On-State Voltage

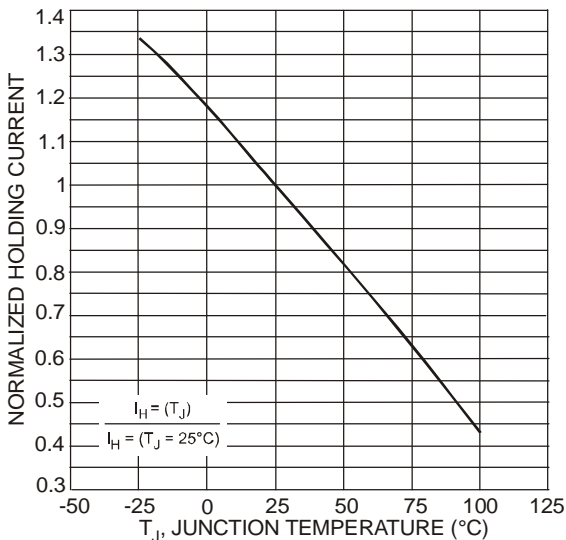

Fig. 5 Relative Variation of Holding Current vs. Junction Temperature

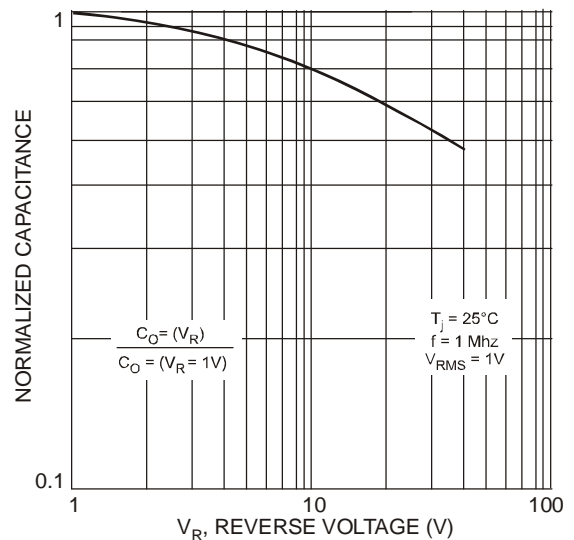
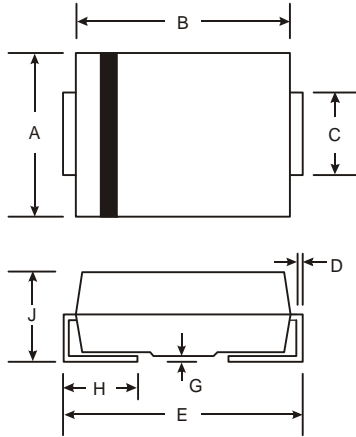

Fig. 6 Relative Variation of Junction Capacitance vs. Reverse Voltage Bias

**Package Outline Dimensions**



SMB		
Dim	Min	Max
A	3.30	3.94
B	4.06	4.57
C	1.96	2.21
D	0.15	0.31
E	5.00	5.59
G	0.05	0.20
H	0.76	1.52
J	2.00	2.50

**All Dimensions in mm**

**Suggested Pad Layout**

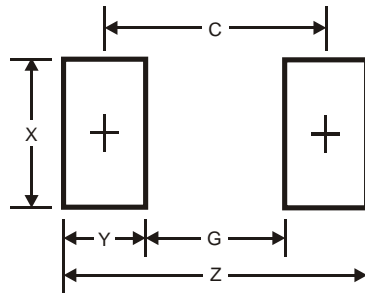

Dimensions	Value (in mm)
Z	6.8
G	1.8
X	2.3
Y	2.5
C	4.3

**IMPORTANT NOTICE**

DIODES INCORPORATED MAKES NO WARRANTY OF ANY KIND, EXPRESS OR IMPLIED, WITH REGARDS TO THIS DOCUMENT, INCLUDING, BUT NOT LIMITED TO, THE IMPLIED WARRANTIES OF MERCHANTABILITY AND FITNESS FOR A PARTICULAR PURPOSE (AND THEIR EQUIVALENTS UNDER THE LAWS OF ANY JURISDICTION).

Diodes Incorporated and its subsidiaries reserve the right to make modifications, enhancements, improvements, corrections or other changes without further notice to this document and any product described herein. Diodes Incorporated does not assume any liability arising out of the application or use of this document or any product described herein; neither does Diodes Incorporated convey any license under its patent or trademark rights, nor the rights of others. Any Customer or user of this document or products described herein in such applications shall assume all risks of such use and will agree to hold Diodes Incorporated and all the companies whose products are represented on Diodes Incorporated website, harmless against all damages.

Diodes Incorporated does not warrant or accept any liability whatsoever in respect of any products purchased through unauthorized sales channel. Should Customers purchase or use Diodes Incorporated products for any unintended or unauthorized application, Customers shall indemnify and hold Diodes Incorporated and its representatives harmless against all claims, damages, expenses, and attorney fees arising out of, directly or indirectly, any claim of personal injury or death associated with such unintended or unauthorized application.

Products described herein may be covered by one or more United States, international or foreign patents pending. Product names and markings noted herein may also be covered by one or more United States, international or foreign trademarks.

**LIFE SUPPORT**

Diodes Incorporated products are specifically not authorized for use as critical components in life support devices or systems without the express written approval of the Chief Executive Officer of Diodes Incorporated. As used herein:

A. Life support devices or systems are devices or systems which:

1. are intended to implant into the body, or
2. support or sustain life and whose failure to perform when properly used in accordance with instructions for use provided in the labeling can be reasonably expected to result in significant injury to the user.

B. A critical component is any component in a life support device or system whose failure to perform can be reasonably expected to cause the failure of the life support device or to affect its safety or effectiveness.

Customers represent that they have all necessary expertise in the safety and regulatory ramifications of their life support devices or systems, and acknowledge and agree that they are solely responsible for all legal, regulatory and safety-related requirements concerning their products and any use of Diodes Incorporated products in such safety-critical, life support devices or systems, notwithstanding any devices- or systems-related information or support that may be provided by Diodes Incorporated. Further, Customers must fully indemnify Diodes Incorporated and its representatives against any damages arising out of the use of Diodes Incorporated products in such safety-critical, life support devices or systems.

Copyright © 2011, Diodes Incorporated

[www.diodes.com](http://www.diodes.com)

Компания «Life Electronics» занимается поставками электронных компонентов импортного и отечественного производства от производителей и со складов крупных дистрибьюторов Европы, Америки и Азии.

С конца 2013 года компания активно расширяет линейку поставок компонентов по направлению коаксиальный кабель, кварцевые генераторы и конденсаторы (керамические, пленочные, электролитические), за счёт заключения дистрибьюторских договоров

Мы предлагаем:

- Конкурентоспособные цены и скидки постоянным клиентам.
- Специальные условия для постоянных клиентов.
- Подбор аналогов.
- Поставку компонентов в любых объемах, удовлетворяющих вашим потребностям.
- Приемлемые сроки поставки, возможна ускоренная поставка.
- Доставку товара в любую точку России и стран СНГ.
- Комплексную поставку.
- Работу по проектам и поставку образцов.
- Формирование склада под заказчика.
- Сертификаты соответствия на поставляемую продукцию (по желанию клиента).
- Тестирование поставляемой продукции.
- Поставку компонентов, требующих военную и космическую приемку.
- Входной контроль качества.
- Наличие сертификата ISO.

В составе нашей компании организован Конструкторский отдел, призванный помогать разработчикам, и инженерам.

Конструкторский отдел помогает осуществить:

- Регистрацию проекта у производителя компонентов.
- Техническую поддержку проекта.
- Защиту от снятия компонента с производства.
- Оценку стоимости проекта по компонентам.
- Изготовление тестовой платы монтаж и пусконаладочные работы.



Тел: +7 (812) 336 43 04 (многоканальный)

Email: [org@lifeelectronics.ru](mailto:org@lifeelectronics.ru)