

- NOTES:
- 1.MATERIALS:  
1-1.HOUSING: SEE TABLE ,GLASS FIBER FILLED UL94V-0, COLOR: SEE TABLE.  
1-2.CONTACT: SEE TABLE
  - 2.PLATING:  
2-1.CONTACT AREA: GOLD, THICKNESS : SEE TABLE .  
2-2.SOLDER TAIL: 100 MICRINCH MIN. TIN PLATING.  
2-3.UNDER PLATING: NICKEL PLATING OVERALL.
  - 3.WEEK CODE: XX(YEAR) XXI(WEEK) XI(LOCATION).
  - 4.PRODUCT SPECIFICATION REFER TO PS-87715-200.
  - 5.PACKAGING SPECIFICATION REFER TO PK-87715-207.
  - 6.TEST SUMMARY:REFER TO TS-87715-207.
  - 7.LEAD FREE AND ROHS COMPLIANCE PRODUCT.

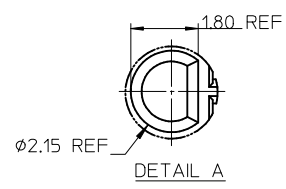
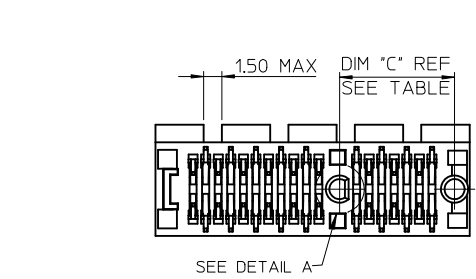
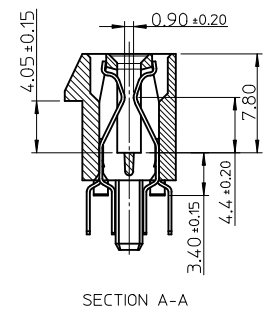
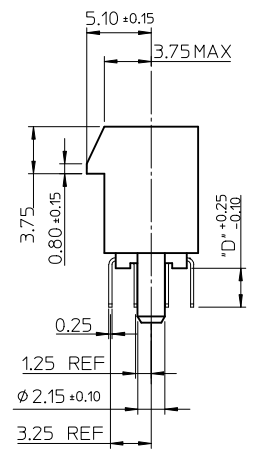
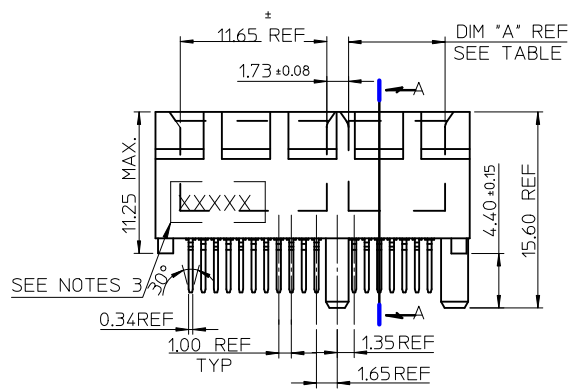

CONNECTOR LINK WIDTH	# POS REF	N	DIM 'A'	DIM 'B'	DIM 'C'
X1	36	6	7.65	25.00	9.15
X4	64	20	21.65	39.00	23.15
X8	98	37	38.65	56.00	40.15
X16	164	70	71.65	89.00	73.15

PCB THK (REF)	DIM 'D'
1.60	2.30
1.58	2.54
2.36	3.00

REVISED IEC NO: SH2010-0468 DRWNR:ZHANG CHKD:ALLEN L LIN APPR:X.J.SONG	2010/06/15 2004/07/20 2010/07/02	DESCRIPTION QUALITY SYMBOLS F=0 E=0 A=0	GENERAL TOLERANCES (UNLESS SPECIFIED)		DIMENSION STYLE MM ONLY		SCALE	DESIGN UNITS METRIC	THIRD ANGLE PROJECTION		
					mm	INCH	DRAWN BY TOM		TITLE		
			4 PLACES ± --- ± ---				DATE 2004/07/20		PCI EXPRESS EDGE CARD CONNECTOR (LEAD FREE VERSION)		
			3 PLACES ± --- ± ---				CHECKED BY ALLEN LIN				
2 PLACES ± 0.25 ± ---				DATE 2004/07/20		MOLEX INCORPORATED SD-87715-207					
1 PLACE ± 0.25 ± ---				APPROVED BY WILSON							
ANGULAR ± 3 °				DATE 2004/07/20		DOCUMENT NO.					
DRAFT WHERE APPLICABLE MUST REMAIN WITHIN DIMENSIONS				MATERIAL NO.		SEE SHEET 4		SHEET NO. 1 OF 4			
				SIZE A3		THIS DRAWING CONTAINS INFORMATION THAT IS PROPRIETARY TO MOLEX INCORPORATED AND SHOULD NOT BE USED WITHOUT WRITTEN PERMISSION					

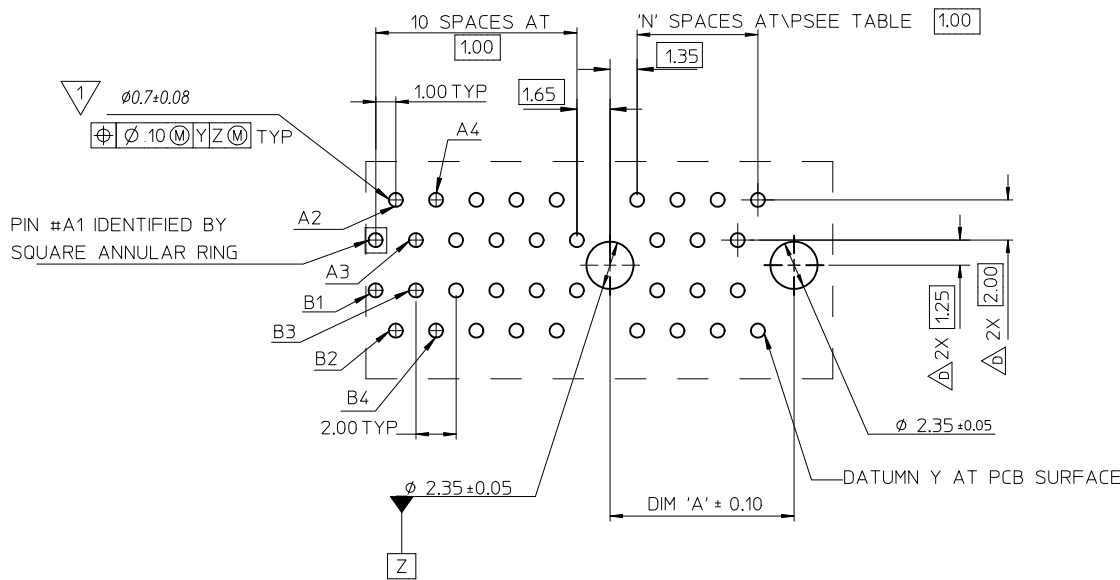

1 THE HORIZONTAL AXIS FOR THE HOLE PATTERN IS ESTABLISHED BY A LINE THROUGH THE CENTER OF THE TWO  $\phi 2.35$  HOLES. THE VERTICAL AXIS IS 90° TO THE HORIZONTAL AXIS. THROUGH THE CENTER OF DATUM Z

PIN #A1 IDENTIFIED BY SQUARE ANNULAR RING

CONNECTOR LINK WIDTH	# POS REF	N	DIM 'A'
X1	36	6	9.15
X4	64	20	23.15
X8	98	37	40.15
X16	164	70	73.15

SEE SHEET 1 EC NO: SH2010-0468 DRAWN: ZHANG 2010/06/15 CHKD: ALLEN LIN 2004/07/20 APPR: XJSONG 2010/07/02	QUALITY SYMBOLS $F_A=0$ $F_G=0$ $F_P=0$	GENERAL TOLERANCES (UNLESS SPECIFIED) mm INCH 4 PLACES ± --- ± --- 3 PLACES ± --- ± --- 2 PLACES ± 0.25 ± --- 1 PLACE ± 0.25 ± --- ANGULAR ± 3°	DIMENSION STYLE MM ONLY DRAWN BY TOM DATE 2004/07/20 CHECKED BY ALLEN LIN DATE 2004/07/20 APPROVED BY WILSON DATE 2004/07/20 MATERIAL NO. SEE SHEET 4	SCALE DESIGN UNITS METRIC THIRD ANGLE PROJECTION	TITLE PCI EXPRESS EDGE CARD CONNECTOR (LEAD FREE VERSION) MOLEX INCORPORATED DOCUMENT NO. SD-87715-207 SHEET NO. 2 OF 4	
	DRAFT WHERE APPLICABLE MUST REMAIN WITHIN DIMENSIONS	SIZE A3	THIS DRAWING CONTAINS INFORMATION THAT IS PROPRIETARY TO MOLEX INCORPORATED AND SHOULD NOT BE USED WITHOUT WRITTEN PERMISSION			

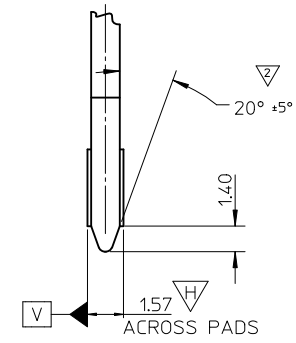
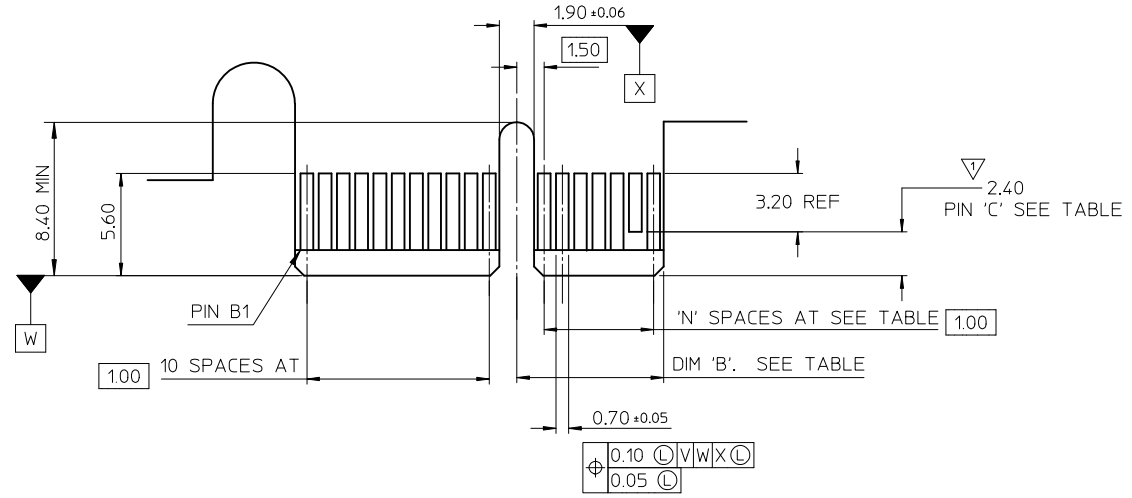

← I/O PANEL DIRECTION

PRIMARY (COMPONENT) SIDE

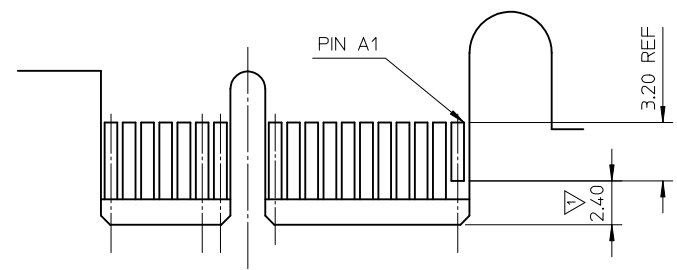

I/O PANEL DIRECTION →

SECONDARY (SOLDER) SIDE

- 1 NO TIE BAR PERMITTED FROM CARD EDGE TO LEADING EDGE OF PAD FOR PINS A1 AND "C".
- 2 CHAMFER EDGES MUST BE FREE OF CUTTING BURRS.
- 3. TOLERANCE: .XX±.13

CONNECTOR LINK WIDTH	# POS REF	N	DIM 'B'	'C' $\Delta$
X1	36	6	8.15	B17
X4	64	20	22.15	B17, B31
X8	98	37	39.15	B17, B31 B48
X16	164	70	72.15	B17, B31 B48, B81

SEE SHEET 1 EC NO: SH2010-0468 DRWR: ZHANG 2010/06/15 CHKD: ALLEN LIN 2004/07/20 APPR: X.J.SONG 2010/07/02	QUALITY SYMBOLS	GENERAL TOLERANCES (UNLESS SPECIFIED)		DIMENSION STYLE	SCALE	DESIGN UNITS	THIRD ANGLE PROJECTION
	$\nabla_{\text{A}}=0$	mm	INCH	MM ONLY		METRIC	
	$\nabla_{\text{B}}=0$	4 PLACES ± --- ± ---		DRAWN BY	DATE	TITLE	
	$\nabla_{\text{C}}=0$	3 PLACES ± --- ± ---		TOM	2004/07/20	PCI EXPRESS EDGE CARD CONNECTOR (LEAD FREE VERSION)	
	2 PLACES ± 0.25 ± ---		CHECKED BY	DATE	MOLEX INCORPORATED		
	1 PLACE ± 0.25 ± ---		ALLEN LIN	2004/07/20	MATERIAL NO. DOCUMENT NO.		
	ANGULAR ± 3°		APPROVED BY	DATE	SD-87715-207		
			WILSON	2004/07/20	SHEET NO.		
			MATERIAL NO.		3 OF 4		
			SEE SHEET 4				
			DRAFT WHERE APPLICABLE MUST REMAIN WITHIN DIMENSIONS				
			THIS DRAWING CONTAINS INFORMATION THAT IS PROPRIETARY TO MOLEX INCORPORATED AND SHOULD NOT BE USED WITHOUT WRITTEN PERMISSION				

MOLEX P/N	CIRCUIT SIZE	HOUSING MATERIAL	HOUSING COLOR	TERMINAL MATERIAL	CONTACT PLATING	SOLDER TAIL 'D' LENGTH
87715-9001	36	NYLON46	BLACK	PHOSPHOR BRONZE	10 MICROINCH	2.54
87715-9003					GOLD FLASH	
87715-9004					10 MICROINCH	3.00
87715-9007					GOLD FLASH	
87715-9008					15 MICROINCH	

MOLEX P/N	CIRCUIT SIZE	HOUSING MATERIAL	HOUSING COLOR	TERMINAL MATERIAL	CONTACT PLATING	SOLDER TAIL 'D' LENGTH
87715-9100	64	NYLON46	BLACK	PHOSPHOR BRONZE	GOLD FLASH	2.54
87715-9101					10 MICROINCH	
87715-9102					15 MICROINCH	3.00
87715-9103					GOLD FLASH	
87715-9104					10 MICROINCH	
87715-9105					15 MICROINCH	2.54
87715-9106					30 MICROINCH	
87715-9107					GOLD FLASH	2.30
87715-9108					15 MICROINCH	
87715-9109					30 MICROINCH	

MOLEX P/N	CIRCUIT SIZE	HOUSING MATERIAL	HOUSING COLOR	TERMINAL MATERIAL	CONTACT PLATING	SOLDER TAIL 'D' LENGTH
87715-9200	98	NYLON46	BLACK	PHOSPHOR BRONZE	GOLD FLASH	2.54
87715-9201					10 MICROINCH	
87715-9202					15 MICROINCH	3.00
87715-9203					GOLD FLASH	
87715-9204					10 MICROINCH	
87715-9205					15 MICROINCH	2.54
87715-9206					30 MICROINCH	
87715-9207					GOLD FLASH	2.30
87715-9208					15 MICROINCH	
87715-9209					30 MICROINCH	

MOLEX P/N	CIRCUIT SIZE	HOUSING MATERIAL	HOUSING COLOR	TERMINAL MATERIAL	CONTACT PLATING	SOLDER TAIL 'D' LENGTH
87715-9602	98	NYLON46	BLACK	BRASS	15 MICROINCH	2.54

MOLEX P/N	CIRCUIT SIZE	HOUSING MATERIAL	HOUSING COLOR	TERMINAL MATERIAL	CONTACT PLATING	SOLDER TAIL 'D' LENGTH
87715-9301	164	NYLON46	BLACK	PHOSPHOR BRONZE	10 MICROINCH	2.54
87715-9304						3.00
87715-9307					GOLD FLASH	2.30
87715-9308					15 MICROINCH	

SEE SHEET 1 EC NO: SH2010-0468 DRWNR: ZHANG 2010/06/15 CHKD: ALLEN LIN 2004/07/20 APPR: XJ.SONG 2010/07/02	QUALITY SYMBOLS	GENERAL TOLERANCES (UNLESS SPECIFIED)	DIMENSION STYLE	SCALE	DESIGN UNITS	THIRD ANGLE PROJECTION	
	$F_A=0$ $F_C=0$ $F_P=0$	mm    INCH 4 PLACES ± --- ± --- 3 PLACES ± --- ± --- 2 PLACES ± 0.25 ± --- 1 PLACE ± 0.25 ± --- ANGULAR ± 3°	MM ONLY	DRAWN BY: TOM    DATE: 2004/07/20 CHECKED BY: ALLEN LIN    DATE: 2004/07/20 APPROVED BY: WILSON    DATE: 2004/07/20	METRIC		
		DRAFT WHERE APPLICABLE MUST REMAIN WITHIN DIMENSIONS	SEE TABLE	MATERIAL NO.	DOCUMENT NO.	PCI EXPRESS EDGE CARD CONNECTOR (LEAD FREE VERSION) MOLEX INCORPORATED	
				SIZE: A3	THIS DRAWING CONTAINS INFORMATION THAT IS PROPRIETARY TO MOLEX INCORPORATED AND SHOULD NOT BE USED WITHOUT WRITTEN PERMISSION		SHEET NO. 4 OF 4

Компания «Life Electronics» занимается поставками электронных компонентов импортного и отечественного производства от производителей и со складов крупных дистрибьюторов Европы, Америки и Азии.

С конца 2013 года компания активно расширяет линейку поставок компонентов по направлению коаксиальный кабель, кварцевые генераторы и конденсаторы (керамические, пленочные, электролитические), за счёт заключения дистрибьюторских договоров

Мы предлагаем:

- Конкурентоспособные цены и скидки постоянным клиентам.
- Специальные условия для постоянных клиентов.
- Подбор аналогов.
- Поставку компонентов в любых объемах, удовлетворяющих вашим потребностям.
- Приемлемые сроки поставки, возможна ускоренная поставка.
- Доставку товара в любую точку России и стран СНГ.
- Комплексную поставку.
- Работу по проектам и поставку образцов.
- Формирование склада под заказчика.
- Сертификаты соответствия на поставляемую продукцию (по желанию клиента).
- Тестирование поставляемой продукции.
- Поставку компонентов, требующих военную и космическую приемку.
- Входной контроль качества.
- Наличие сертификата ISO.

В составе нашей компании организован Конструкторский отдел, призванный помогать разработчикам, и инженерам.

Конструкторский отдел помогает осуществить:

- Регистрацию проекта у производителя компонентов.
- Техническую поддержку проекта.
- Защиту от снятия компонента с производства.
- Оценку стоимости проекта по компонентам.
- Изготовление тестовой платы монтаж и пусконаладочные работы.



Тел: +7 (812) 336 43 04 (многоканальный)

Email: [org@lifeelectronics.ru](mailto:org@lifeelectronics.ru)