

### Applications

- HFC Nodes
- CATV Line Amplifiers
- Head End Equipment

### Product Features

- Frequency Range: 40 MHz – 1218 MHz
- 20 dB Flat Gain
- 800  $\Omega$  Transimpedance<sup>(1)</sup>
- < 5 pA /  $\sqrt{\text{Hz}}$  Equivalent Input Noise Current<sup>(1)</sup>
- 1.5 dB 75  $\Omega$  Noise Figure
- Ultra-Low Distortion (+45 dBm IP3 typ.)
- Low DC Power Consumption
- Single Supply Bias (+8 V)
- Proven GaAs Technology
- 20 Pin 4.0 x 4.0 x 0.9 mm QFN Package

Notes:

1. Includes 1:1 balun, No photodiode or auto-transformer

### General Description

The TriQuint TGA2803-SM is an ultra-linear, packaged TIA/Gain Block which operates from 40 MHz to 1218 MHz.

The TGA2803-SM typically provides flat gain along with ultra-low distortion. It also provides high output power with low DC power consumption.

This amplifier is ideally suited for use in CATV distribution systems or other applications requiring extremely low noise and distortion.

Demonstration Boards are available.  
Lead-free and RoHS compliant.

### Ordering Information

Part No.	Description
TGA2803-SM	QFN 20L 4 x 4 Surface Mount
TGA2803-SM-EVB	

Standard T/R size = 2,500 pieces on a 7" reel.

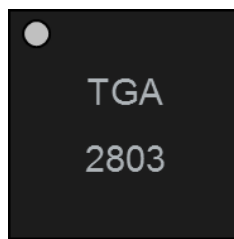

Top View

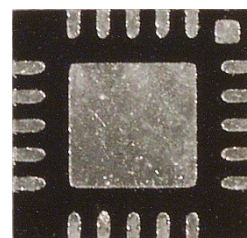

Bottom View

### Measured Performance

75  $\Omega$  Output TOI

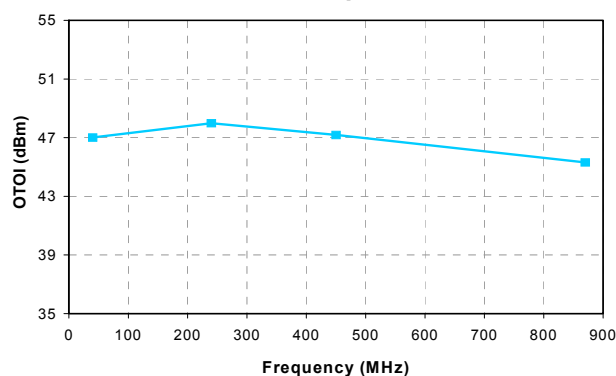

Input Referred Current Noise with High Impedance source

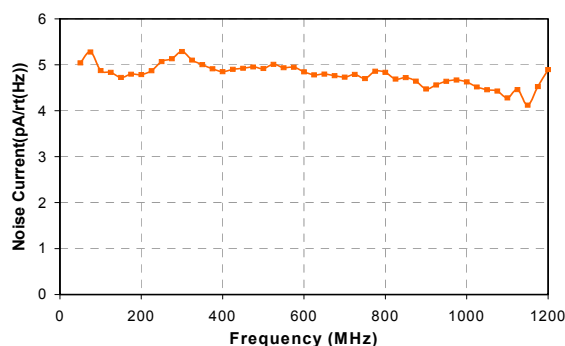

Typical 75  $\Omega$  Gain w/External Balun Losses Removed

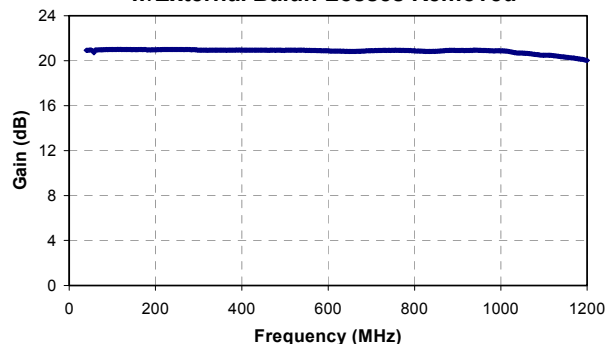

### Absolute Maximum Ratings

Parameter	Rating
Bias Supply Voltage ( $V_{DD}$ )	+15 V
Total Bias Supply Current ( $I_{DD}$ )	500 mA
Total RF Input Power ( $P_{IN}$ )	77 dBmV
Storage Temperature ( $T_{STG}$ )	-65 to 150 °C

Operation of this device outside the parameter ranges given above may cause permanent damage.

### Recommended Operating Conditions

Parameter	Min	Typ	Max	Units
Bias Supply Voltage		+8		V
Bias Supply Current		350		mA
Gate 1 Voltage (Pin 19)		+0.90		V
Gate 2 Voltage (Pin 7)		+2.66		V
$T_{AMB}$	-30	25	+85	°C
$T_j$ (for >10 <sup>6</sup> hours MTTF)			200	°C

Electrical performance is measured under conditions noted in the electrical specifications table. Specifications are not guaranteed over all recommended operating conditions.

### RF Specifications

Test conditions unless otherwise stated:  $T_A=+25$  °C,  $V_{DD}=+8$  V, Using electrical application circuit on pg. 9

Parameter	Symbol	Min	Typ	Max	Units
Bandwidth	BW	40		1218	MHz
Power Gain <sup>(1)</sup>	$S_{21}$		20		dB
Gain Flatness	GF		±0.3		dB
Adjacent Channel Power Ratio <sup>(1)</sup>	ACPR1	-63	-66		dBc
Noise Figure	NF		1.5		dB
Transimpedance	TZ		800		Ω
Equivalent Input Current Noise <sup>(2)</sup>	$I_n$		5		pA / rtHz
Two-Tone, Third-Order Intercept (450 MHz) <sup>(3)</sup>	IP3		+46		dBm
Two-Tone, Third-Order Intercept (750 MHz) <sup>(3)</sup>	IP3		+42		dBm
Input Return Loss	IRL		10		dB
Output Return Loss	ORL		17		dB
Drain Current <sup>(4)</sup>	$I_D$	250	350	500	mA
Saturated Output Power (750 MHz)	$P_{sat}$		+28		dBm

Notes:

1. Measured at 858 MHz with a single 6 MHz wide channel, 256QAM signal at 62 dBmV average output power (into 75 Ω). ACP is measured in the channel that is offset from the signal band edge by 750 kHz to 6 MHz. Gain is also measured at this frequency.
2. Measured with open-circuited input
3. Measured at +16 dBm output power per tone
4. Increasing drain current will improve linearity of device

### Thermal Information

Parameter	Conditions	$T_{CH}$ (°C)	$\theta_{JC}$ (°C/W)	$T_M$ (HRS)
$\theta_{JC}$ Thermal Resistance (channel to backside of package)	$V_D=+8$ V, $I_D=350$ mA $P_{DISS}=2.8$ W	128	15.4	7.2 E+6

Notes:

1. Worst case condition with no RF applied, 100% of DC power is dissipated. Package backside temperature at +85 °C.

**Typical Measured S-Parameters (75 Ω) : TGA2803-SM-EVB**

Includes effects of external baluns

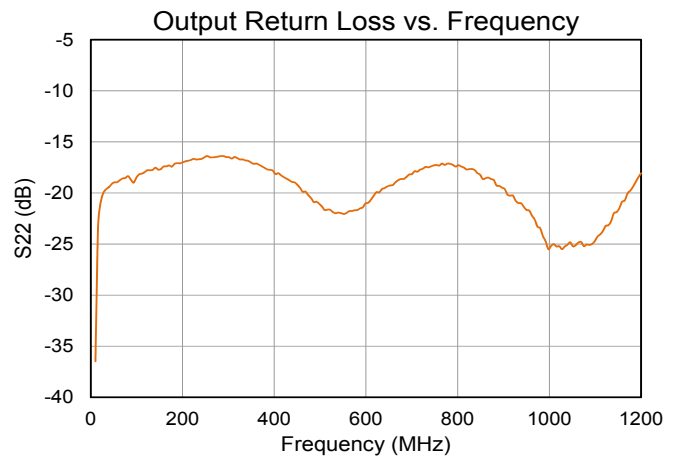
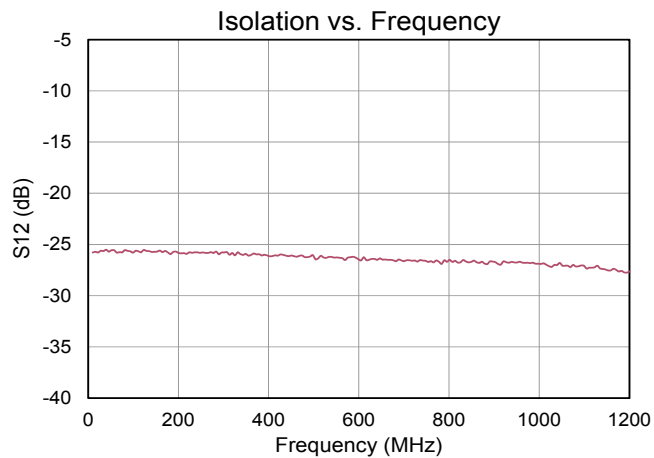
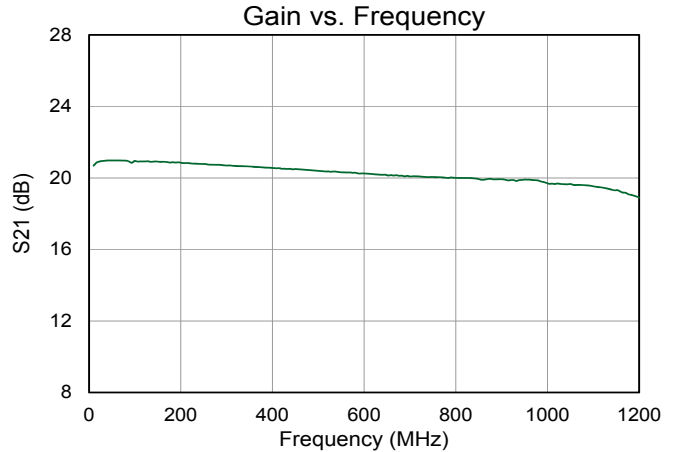
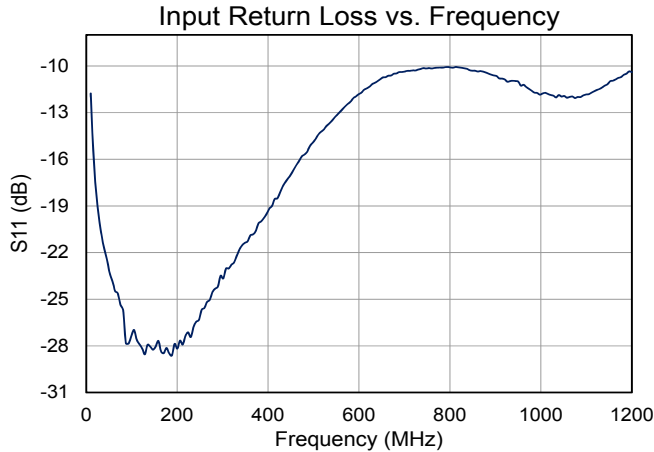

**Typical Performance TGA2803-SM-EVB**

Test conditions unless otherwise stated:  $V_D=+8\text{ V}$ ,  $I_D=350\text{ mA}$  (Includes effects of external baluns)

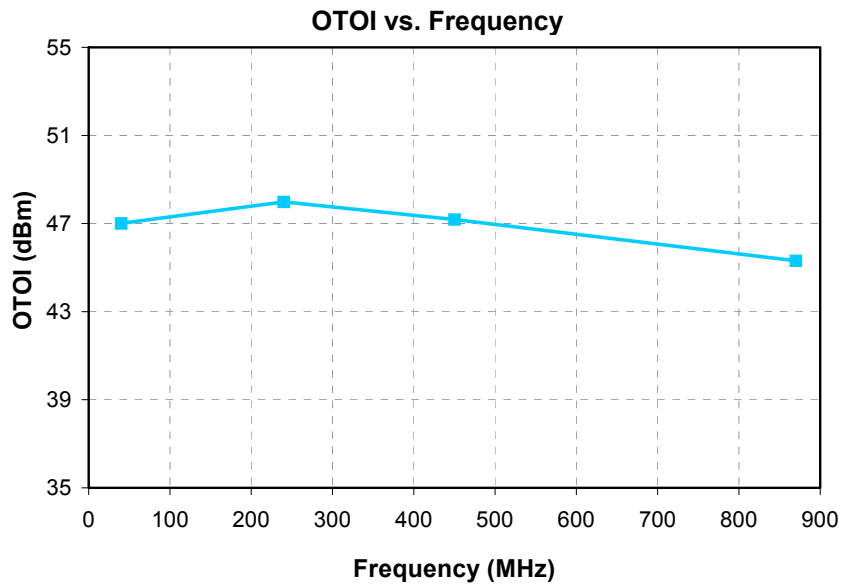
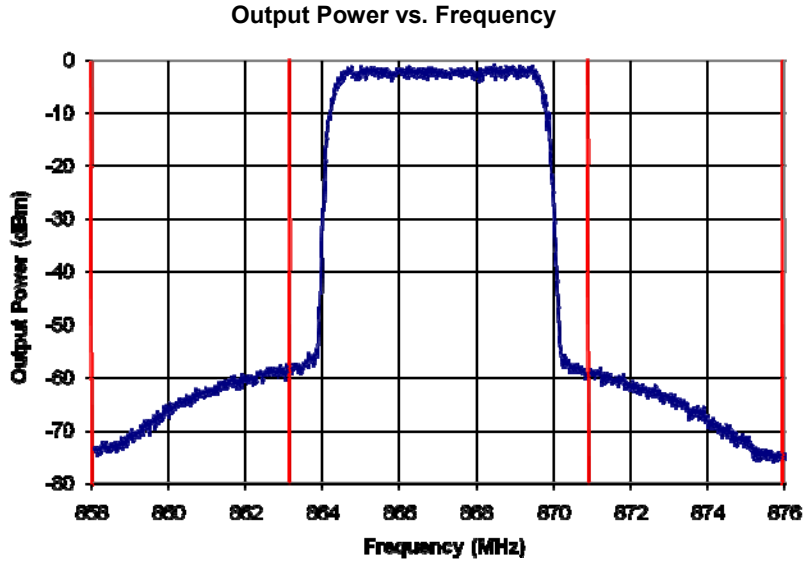

**Typical Performance TGA2803-SM-EVB**

Includes effects of external baluns

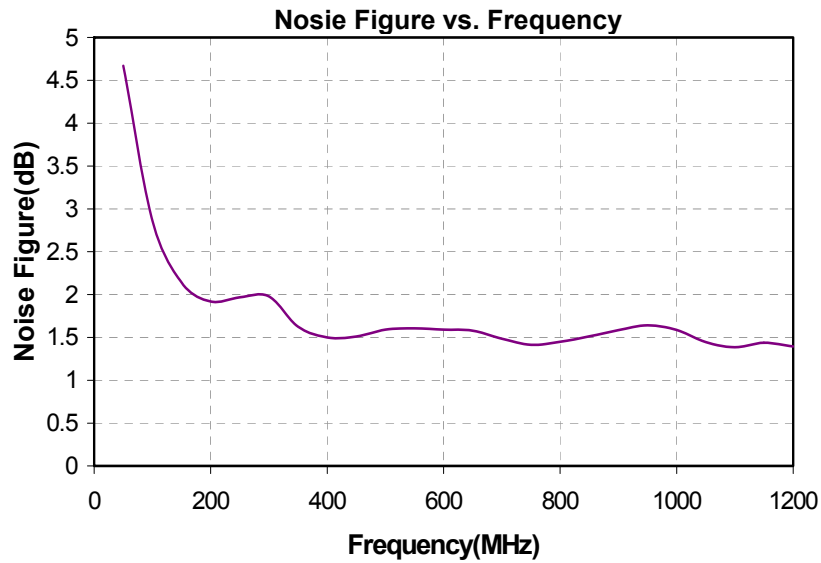
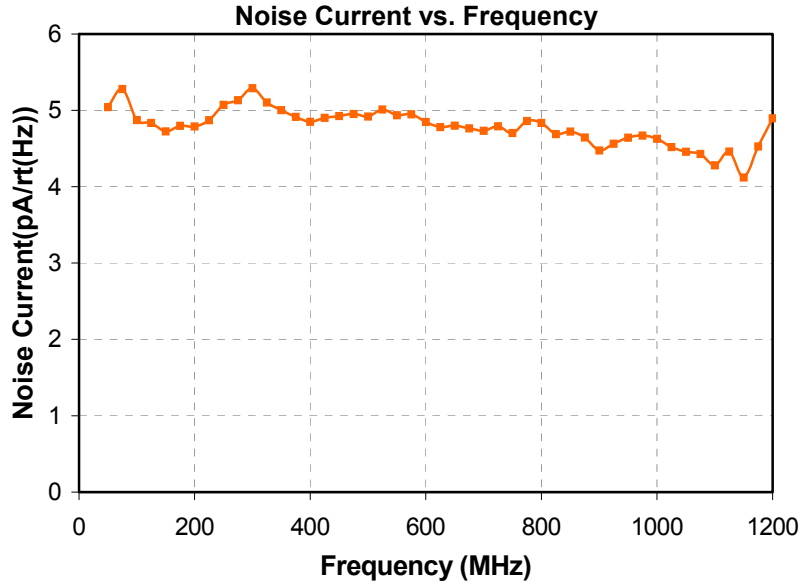

*\*Input balun losses removed*

**Typical Performance TGA2803-SM-EVB**

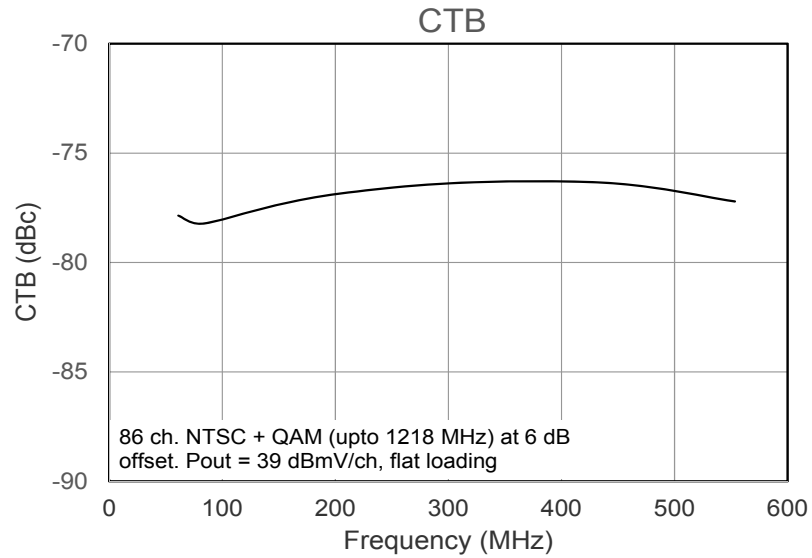
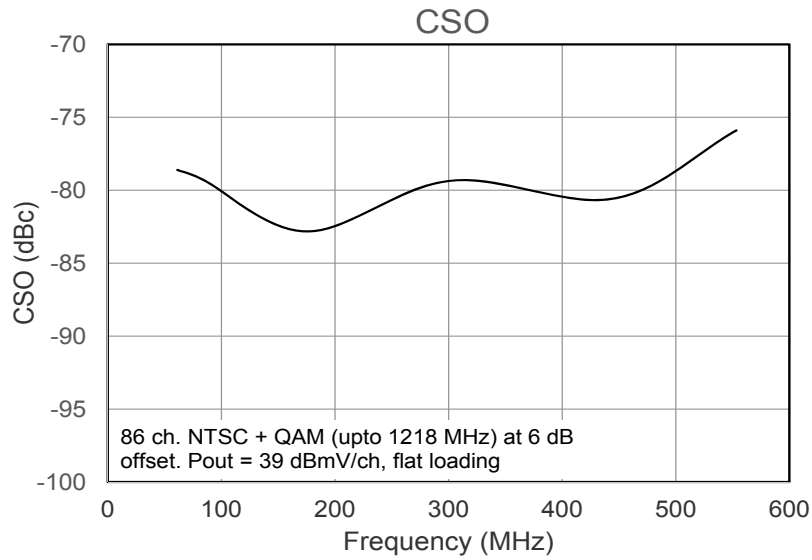

## PCB Layout

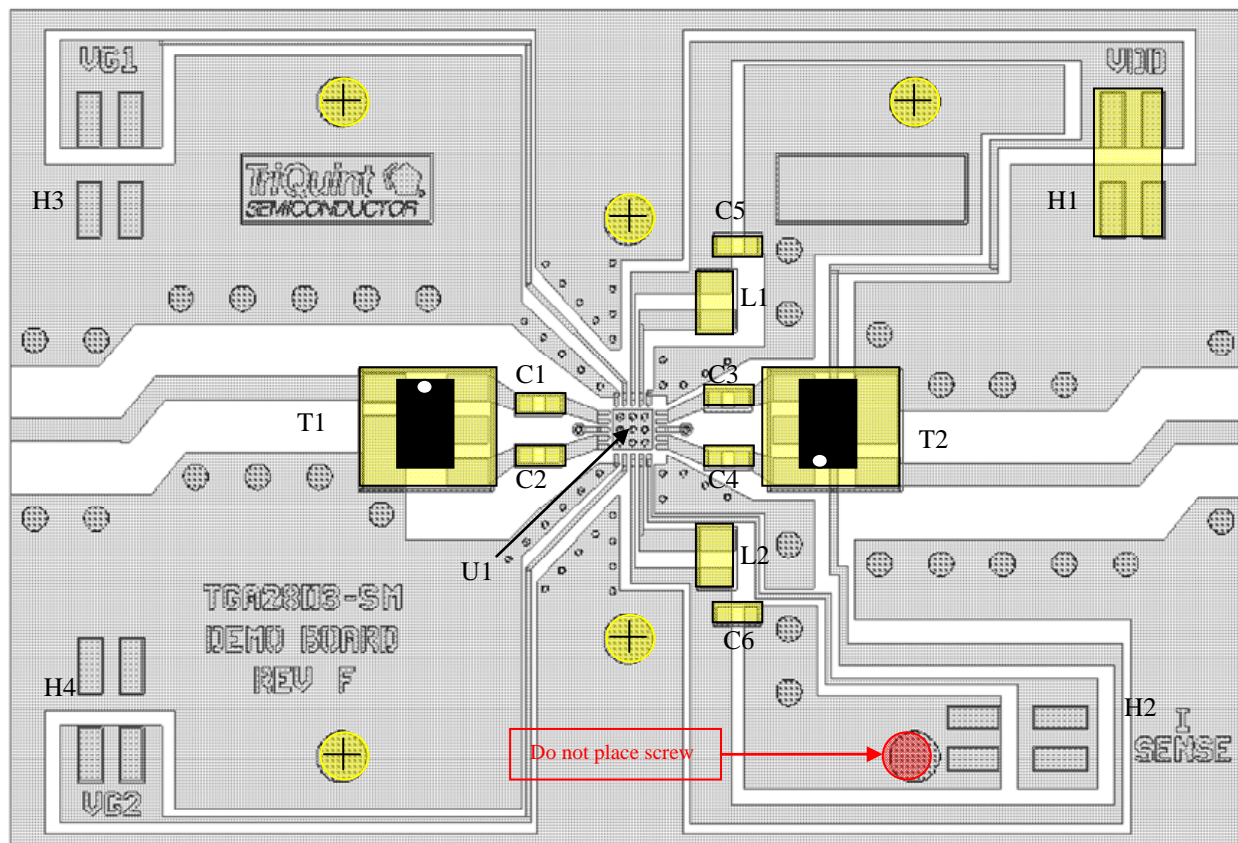

## Bill of Material – TGA2803-SM-EVB

Ref Des	Value	Description
U1		TGA2803-SM 40 MHz – 1 GHz, Gain Block
C1, C2	0.01 $\mu$ F	Cap, ceramic, 0603, 50 V, 5%
C3, C4	470 pF	Cap, ceramic, 0603, 50 V, 5%
C5, C6	270 pF	Cap, ceramic, 0603, 50 V, 5%
L1, L2	820 nH	Ind, wire-wound, 400 mA, 5%
T1, T2		Transformer, 75 $\Omega$
H1		Conn, Header, 2 Pos. 0.1" RA,
J3, J4		Conn, Precision N 75 ohm panel mount
PCB	Rev F	TGA2803-SM Demo Board, Rev.F
Heatsink		60-0130REV1 Heatsink, for 0.062"
Screws		Philps, 4-40 screw
Screws		Socket, 4-40 screw

**Mechanical Information**

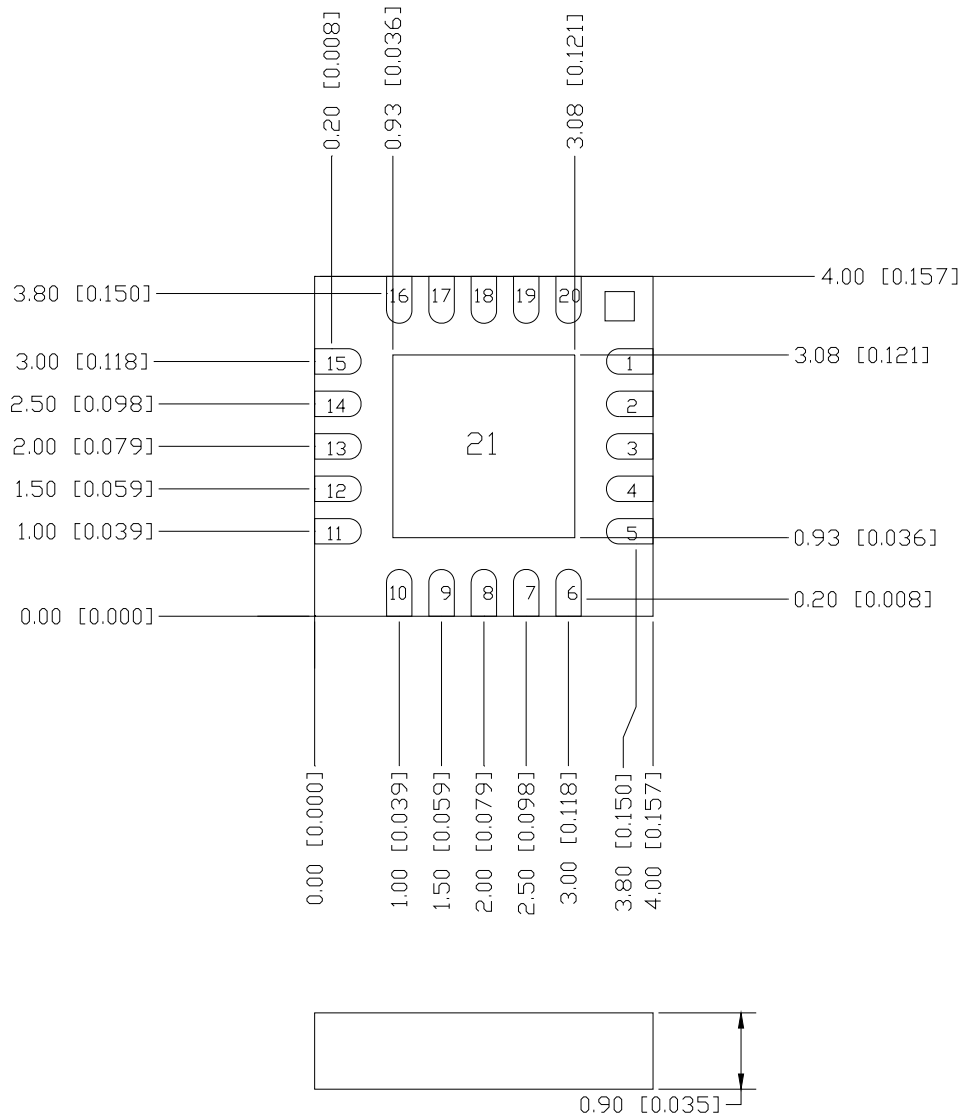

Unit: millimeters (inches)  
Package Tolerance  $\pm 0.10$  (0.004)



## Pin Layout & Description

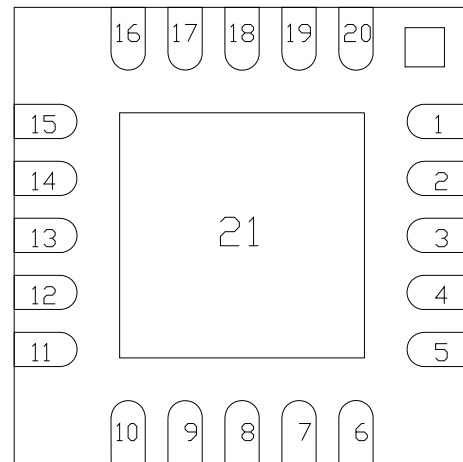
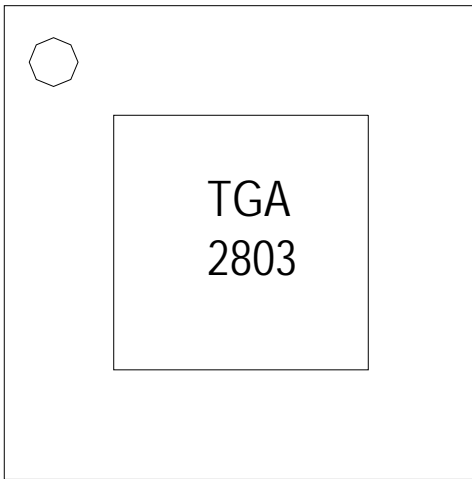

Pin No	Description	Pin No	Description
1	RF Input 1	11	RF Output 2
2	RF Input 1	12	RF Output 2
3	GND	13, 21	GND
4	RF Input 2	14	RF Output 1
5	RF Input 2	15	RF Output 1
6	NC	16	NC
7	VG2 (Optional)	17	V <sub>DD</sub> (choked)
8	V <sub>DD</sub>	18	V <sub>DD</sub>
9	V <sub>DD</sub> (choked)	19	V <sub>G1</sub> (Optional)
10	I <sub>sense</sub> <sup>(1)</sup>	20	NC

Notes:

1. Bias current monitor:  $I_{sense} = (\text{Voltage}_{pin\ 10}) / 4\Omega$

**Application Diagrams**

**Electrical Gain Amplifier**

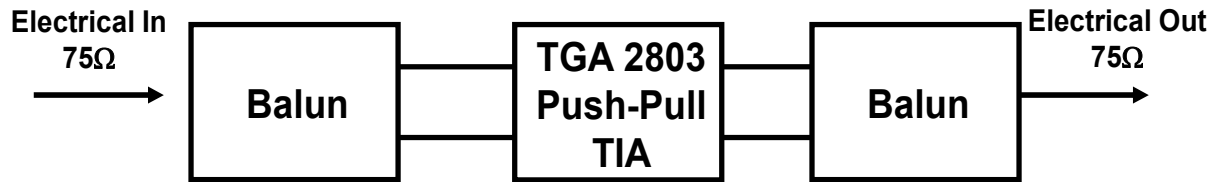

**Optical Receiver**

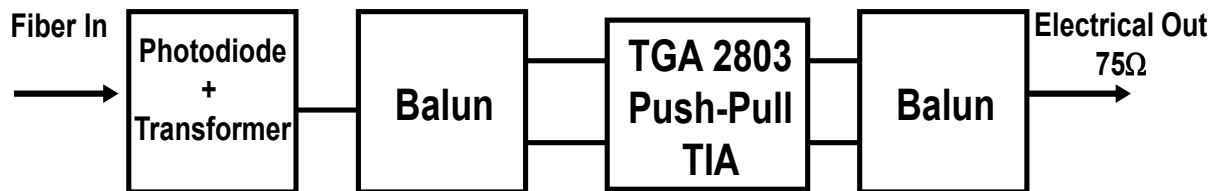

## Recommended Electrical Assembly

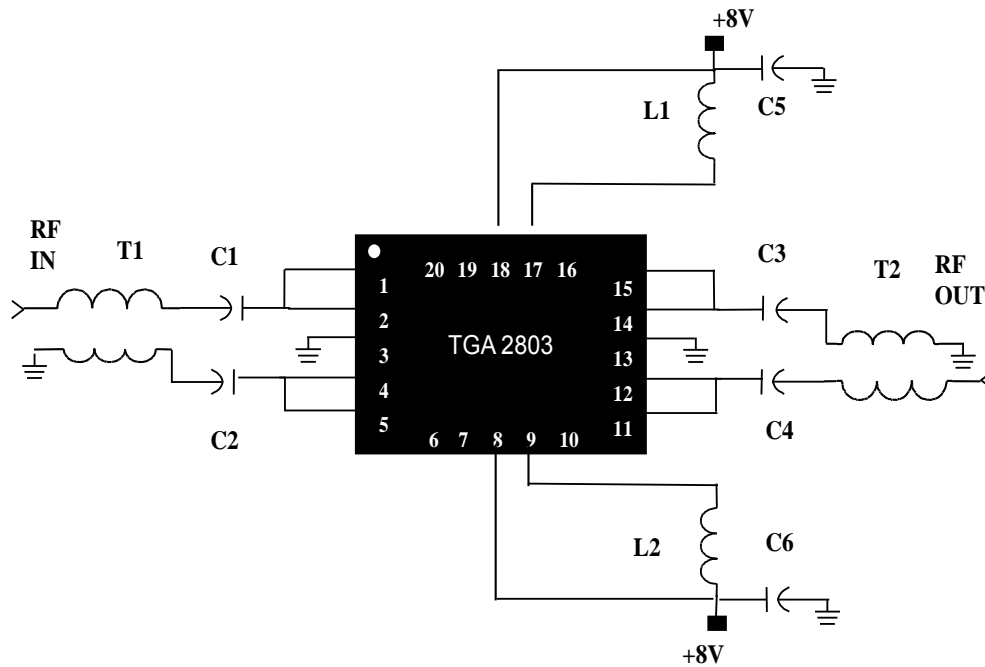

## Component Description

Parameter	Description
C1	0.014 $\mu$ F Capacitor
C2	0.01 $\mu$ F Capacitor
C3	470 pF Capacitor
C4	470 pF Capacitor
C5	270 pF Capacitor
C6	270 pF Capacitor
L1	820 nH Inductor
L2	820 nH Inductor
T1	Balun <sup>(1)</sup>
T2	Balun <sup>(1)</sup>

### Notes:

- Balun performance impacts amplifier return losses and gain. Best performance can be achieved by winding 34 or 36 gauge bifilar wire around a small binocular core made from low-loss magnetic material. Suitable wire may be obtained from MWS Wire Industries. Core vendors include Ferronics, Fairrite, TDK, and Micrometals.

Alternatively, off-the-shelf baluns can be purchased from a number of vendors including Mini-Circuits (ADTL1-18-75), M/A-COM (ETC1-1-13), and Pulse Engineering (CX2071).

## Recommended Electro-Optical Assembly

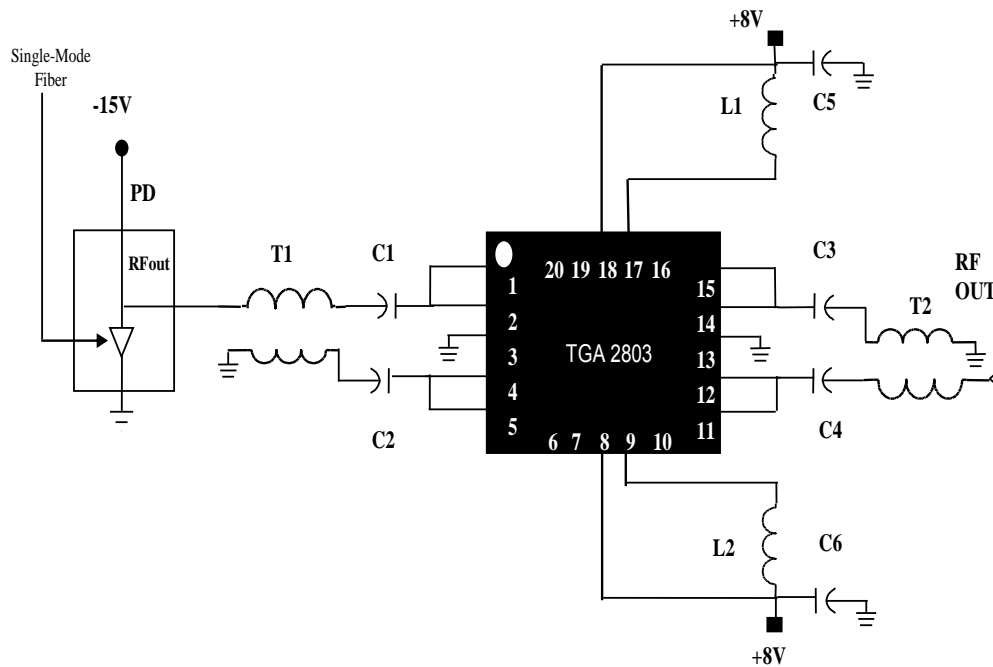

## Component Description

Parameter	Description
C1	0.014 $\mu\text{F}$ Capacitor
C2	0.01 $\mu\text{F}$ Capacitor
C3	470 pF Capacitor
C4	470 pF Capacitor
C5	270 pF Capacitor
C6	270 pF Capacitor
L1	820 nH Inductor
L2	820 nH Inductor
T1	Balun <sup>(1)</sup>
T2	Balun <sup>(1)</sup>
PD	Broadband Photodiode <sup>(2)</sup>

### Notes:

- Balun performance impacts amplifier return losses and gain. Best performance can be achieved by winding 34 or 36 gauge bifilar wire around a small binocular core made from low-loss magnetic material. Suitable wire may be obtained from MWS Wire Industries. Core vendors include Ferronics, Fairrite, TDK, and Micrometals.
- Alternatively, off-the-shelf baluns can be purchased from a number of vendors including Mini-Circuits (ADTL1-18-75), M/A-COM (ETC1-1-13), and Pulse Engineering (CX2071). Emcore 2609C Broadband Photodiode Module is recommended. The module includes a 4:1 impedance transformer.

**Recommended Surface Mount Package Assembly**

Proper ESD precautions must be followed while handling packages.

Clean the board with acetone. Rinse with alcohol. Allow the circuit to fully dry.

TriQuint recommends using a conductive solder paste for attachment. Follow solder paste and reflow oven vendors' recommendations when developing a solder reflow profile. Typical solder reflow profiles are listed in the table below.

Hand soldering is not recommended. Solder paste can be applied using a stencil printer or dot placement. The volume of solder paste depends on PCB and component layout and should be well controlled to ensure consistent mechanical and electrical performance.

Clean the assembly with alcohol.



Caution! ESD-Sensitive Device

GaAs MMIC devices are susceptible to damage from Electrostatic Discharge. Proper precautions should be observed during handling, assembly and test.

**Typical Solder Reflow Profiles**

Reflow Profile	SnPb	Pb Free
Ramp-up Rate	3 °C / sec	3 °C / sec
Activation Time and Temperature	60 – 120 sec at 140 – 160 °C	60 – 180 sec at 150 – 200 °C
Time above Melting Point	60 – 150 sec	60 – 150 sec
Max Peak Temperature	240 °C	260 °C
Time within 5 °C of Peak Temperature	10 – 20 sec	10 – 20 sec
Ramp-down Rate	4 – 6 °C / sec	4 – 6 °C / sec

## Contact Information

For the latest specifications, additional product information, worldwide sales and distribution locations, and information about TriQuint:

**Web:** [www.triquint.com](http://www.triquint.com)

**Tel:** +1.972.994.8465

**Email:** [info-sales@triquint.com](mailto:info-sales@triquint.com)

**Fax:** +1.972.994.8504

For technical questions and application information:

**Email:** [info-products@triquint.com](mailto:info-products@triquint.com)

## Important Notice

The information contained herein is believed to be reliable. TriQuint makes no warranties regarding the information contained herein. TriQuint assumes no responsibility or liability whatsoever for any of the information contained herein. TriQuint assumes no responsibility or liability whatsoever for the use of the information contained herein. The information contained herein is provided "AS IS, WHERE IS" and with all faults, and the entire risk associated with such information is entirely with the user. All information contained herein is subject to change without notice. Customers should obtain and verify the latest relevant information before placing orders for TriQuint products. The information contained herein or any use of such information does not grant, explicitly or implicitly, to any party any patent rights, licenses, or any other intellectual property rights, whether with regard to such information itself or anything described by such information.

TriQuint products are not warranted or authorized for use as critical components in medical, life-saving, or life-sustaining applications, or other applications where a failure would reasonably be expected to cause severe personal injury or death.

Компания «Life Electronics» занимается поставками электронных компонентов импортного и отечественного производства от производителей и со складов крупных дистрибьюторов Европы, Америки и Азии.

С конца 2013 года компания активно расширяет линейку поставок компонентов по направлению коаксиальный кабель, кварцевые генераторы и конденсаторы (керамические, пленочные, электролитические), за счёт заключения дистрибьюторских договоров

Мы предлагаем:

- Конкурентоспособные цены и скидки постоянным клиентам.
- Специальные условия для постоянных клиентов.
- Подбор аналогов.
- Поставку компонентов в любых объемах, удовлетворяющих вашим потребностям.
- Приемлемые сроки поставки, возможна ускоренная поставка.
- Доставку товара в любую точку России и стран СНГ.
- Комплексную поставку.
- Работу по проектам и поставку образцов.
- Формирование склада под заказчика.
- Сертификаты соответствия на поставляемую продукцию (по желанию клиента).
- Тестирование поставляемой продукции.
- Поставку компонентов, требующих военную и космическую приемку.
- Входной контроль качества.
- Наличие сертификата ISO.

В составе нашей компании организован Конструкторский отдел, призванный помогать разработчикам, и инженерам.

Конструкторский отдел помогает осуществить:

- Регистрацию проекта у производителя компонентов.
- Техническую поддержку проекта.
- Защиту от снятия компонента с производства.
- Оценку стоимости проекта по компонентам.
- Изготовление тестовой платы монтаж и пусконаладочные работы.



Тел: +7 (812) 336 43 04 (многоканальный)

Email: [org@lifeelectronics.ru](mailto:org@lifeelectronics.ru)