

AC/DC Converter

Non-Isolation Buck Converter PWM method Output 7.5W 15V

BM2P0161 Reference Board

BM2P0161-EVK-001

The BM2P0161-EVK-001 evaluation board outputs 15V voltage from the input of 90Vac to 264Vac. The output current supplies up to 0.5A. BM2P0161 which is PWM method DC/DC converter IC built-in 650V MOSFET is used.

The BM2P0161 contributes to low power consumption by built-in a 650 V starting circuit.

Current mode control imposes current limitation on every cycle, providing superior performance in bandwidth and transient response. The switching frequency is 65 kHz in fixed mode. At light load, frequency is reduced and high efficiency is realized. Built-in frequency hopping function contributes to low EMI. Low on-resistance 1.0 Ω 650 V MOSFET built-in contributes to low power consumption and easy design.

The flywheel diode is a fast recovery diode of 3A/600 V RFN3BM6S, contributing to low power consumption.

The conduction / radiation emission test is based on CISPR 22 Class B with best EMI design.

Electronics Characteristics

Not guarantee the characteristics, is representative value. Unless otherwise noted : $V_{IN} = 230Vac$, $I_{OUT} = 500mA$, $T_a:25^{\circ}C$

Parameter	Min	Typ	Max	Units	Conditions
Input Voltage Range	90	230	264	Vac	
Input Frequency	47	50/60	63	Hz	
Output Voltage	13.5	15.0	16.5	V	
Maximum Output Power	-	-	7.5	W	$I_{OUT} = 500mA$
Output Current Range (NOTE1)	0	-	500	mA	
Stand-by Power	-	36	-	mW	$I_{OUT} = 0A$
Efficiency	-	82.9	-	%	
Output Ripple Voltage (NOTE2)	-	64	-	mVpp	
Operating Temperature Range	-10	25	65	$^{\circ}C$	

(NOTE1) Please adjust operating time, within any parts surface temperature under 105 $^{\circ}C$

(NOTE2) Not include spike noise

Operation Procedure

1. Operation Equipment

- (1) AC Power supply 90Vac~264Vac, over 10W
- (2) Electronic Load capacity 0.5A
- (3) Multi meter

2. Connect method

- (1) AC power supply presetting range 90~264Vac, Output switch is off.
- (2) Load setting under 0.5A. Load switch is off.
- (3) AC power supply N terminal connect to the board AC (N) of CN1, and L terminal connect to AC (L).
- (4) Load + terminal connect to VOUT, GND terminal connect to GND terminal
- (5) AC power meter connect between AC power supply and board.
- (6) Output test equipment connects to output terminal
- (7) AC power supply switch ON.
- (8) Check that output voltage is 15V.
- (9) Electronic load switch ON
- (10) Check output voltage drop by load connect wire resistance

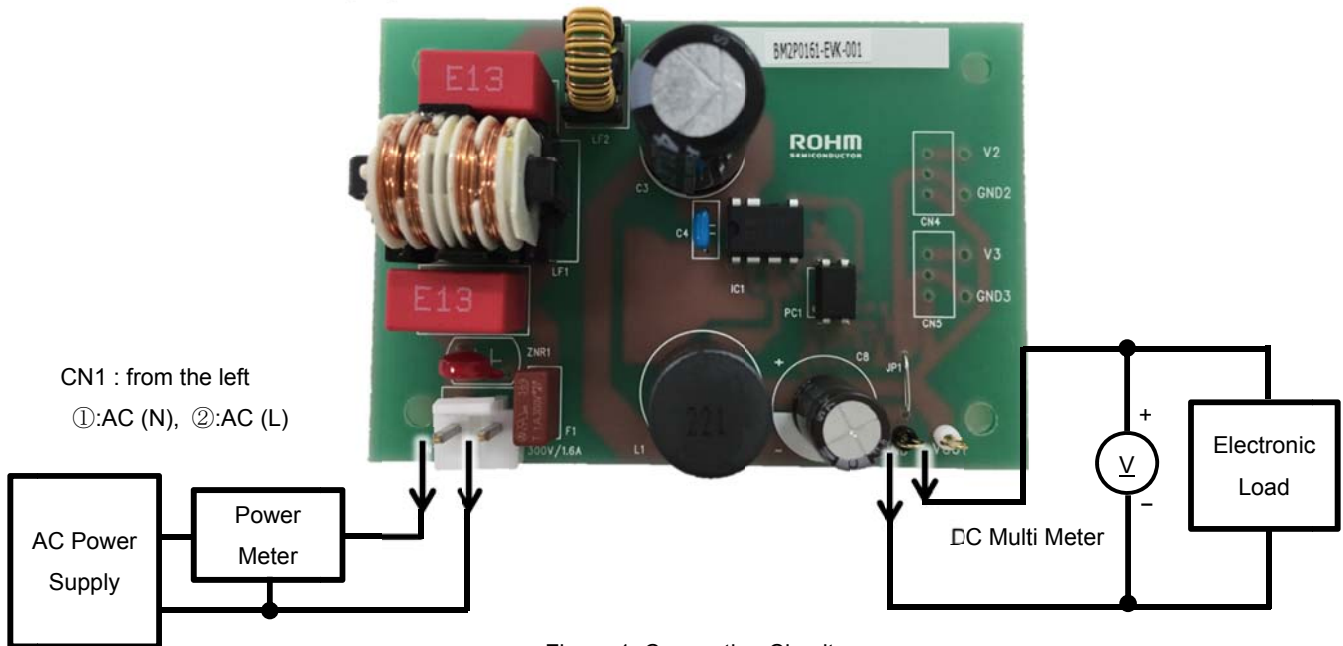

Figure 1. Connection Circuit

Deleting

Maximum Output Power P_o of this reference board is 7.5W. The derating curve is shown on the right.

Please adjust load continuous time by over 105°C of any parts surface temperature within the operating temperature range (-10~65°C).

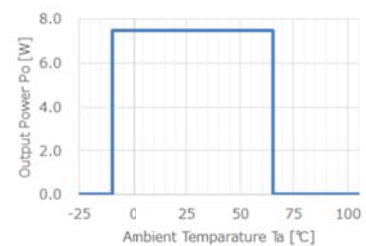

Figure 2. Temperature Deleting curve

Schematics

$V_{IN} = 90 \sim 264V_{ac}$, $V_{OUT} = 15V$

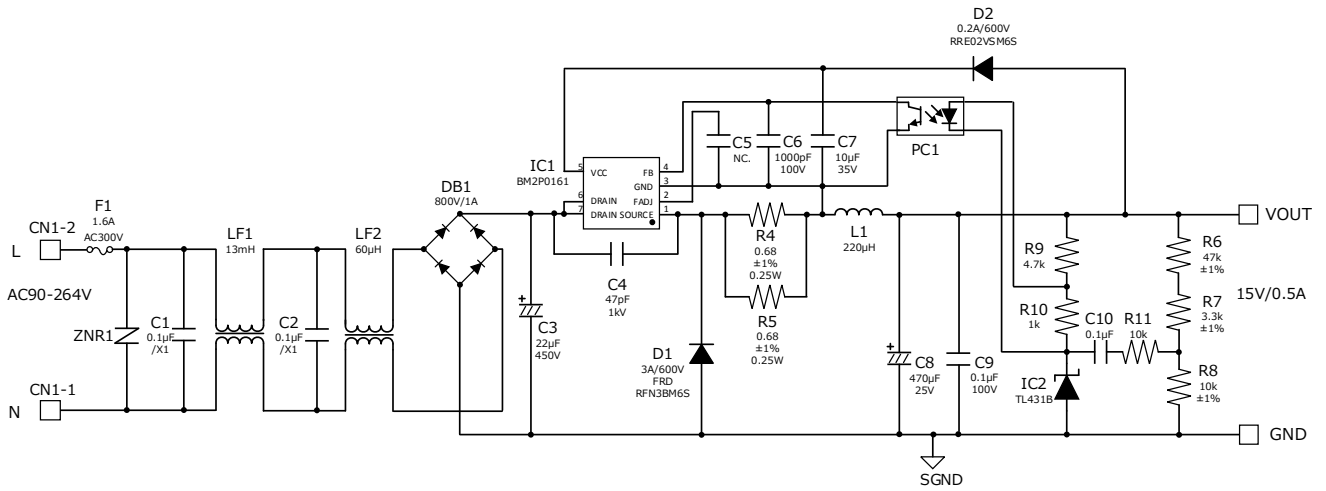

Figure 3. BM2P0161-EVK-001 Schematics

Bill of Materials

Table 1. BoM of BM2P0161-EVK-001

Part Reference	Qty.	Type	Value	Description	Part Number	Manufacture	Configuration mm (inch)
C1,C2	2	Film	0.1μF	X2	890324023023CS	Wurth	-
C3	1	Electrolytic	22μF	450V	450BXW22MEFR12.5X20	Rubycon	-
C4	1	Ceramic	47pF	1000V, X7R, ±10%	RDER73A470J2K1H03B	Murata	-
C5	0	Ceramic	-	-	-	-	1608 (0603)
C6	1	Ceramic	1000pF	100V, X7R, ±20%	HMK107B7102MA-T	Taiyo Yuden	1608 (0603)
C7	1	Ceramic	10μF	35V, X7R, ±20%	GMK316AB7106ML-TR	Taiyo Yuden	3216 (1206)
C8	1	Electrolytic	470μF	25V, Low-Z	UPA1E471MPD	Nichicon	-
C9,C10	2	Ceramic	0.1μF	100V, X7R, ±20%	HMK107B7104MA-T	Taiyo Yuden	1608 (0603)
CN1	1	Connector	-	2pin	B2P-NV	JST	-
D1	1	FRD	3A	600V	RFN3BM6S	ROHM	TO-252
D2	1	Diode	0.2A	600V	RRE02VSM6S	ROHM	TUMD2SM
DB1	1	Bridge	1A	800V	D1UBA80	Shindengen	SOPA-4
F1	1	Fuse	1.6A	300Vac	36911600000	LittelleFuse	-
IC1	1	AC/DC Converter	-	-	BM2P0161-Z	ROHM	DIP7
IC2	1	Shunt Regulator	-	±0.5%	TL431BIDBZT	TI	SOT-23-3
L1	1	Coil	220μH	1.9A	XF1501Y-221	Alpha Trans	φ13.5
LF1	1	Line Filter	13mH	1A	XF1482Y	Alpha Trans	-
LF2	1	Line Filter	60μH	1A	LF1246Y	Alpha Trans	-
PC1	1	Optocoupler	-	5kV	LTV-817-B	LiteOn	DIP4
R4,R5	2	Resistor	0.68Ω	0.25W, ±1%	MCR18EZHLR680	ROHM	3216 (1206)
R6	1	Resistor	47kΩ	0.1W, ±1%	MCR03EZPFX4702	ROHM	1608 (0603)
R7	1	Resistor	3.3kΩ	0.1W, ±1%	MCR03EZPFX3301	ROHM	1608 (0603)
R8	1	Resistor	10kΩ	0.1W, ±1%	MCR03EZPFX1002	ROHM	1608 (0603)
R9	1	Resistor	4.7kΩ	0.1W, ±1%	MCR03EZPFX4701	ROHM	1608 (0603)
R10	1	Resistor	1kΩ	0.1W, ±5%	MCR03EZPJ102	ROHM	1608 (0603)
R11	1	Resistor	10kΩ	0.1W, ±5%	MCR03EZPJ103	ROHM	1608 (0603)
ZNR1	1	Varistor	-	470V, 400A	V470ZA05P	LittelleFuse	-

PCB

Size : 55 mm x 80 mm

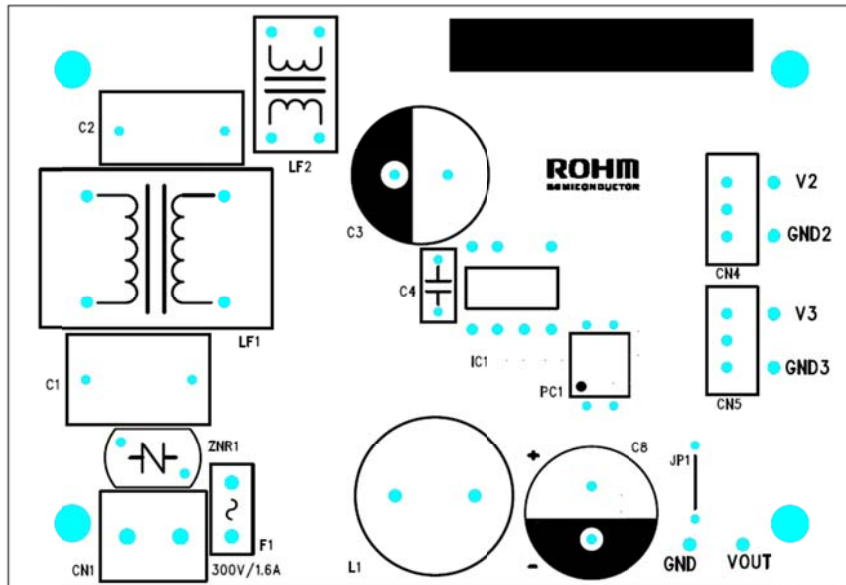

Figure 4. Top Silkscreen (Top view)

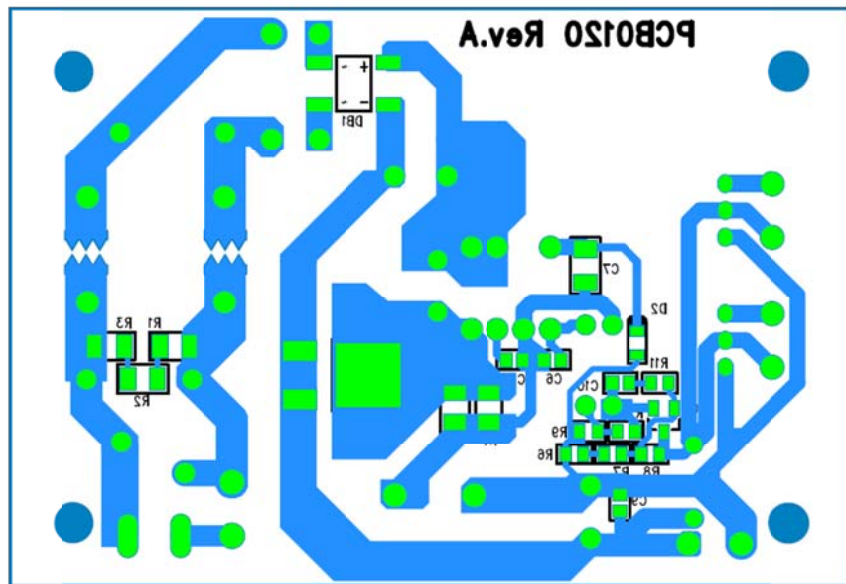

Figure 5. Bottom Layout (Top view)

Performance Data

· Constant Load Regulations

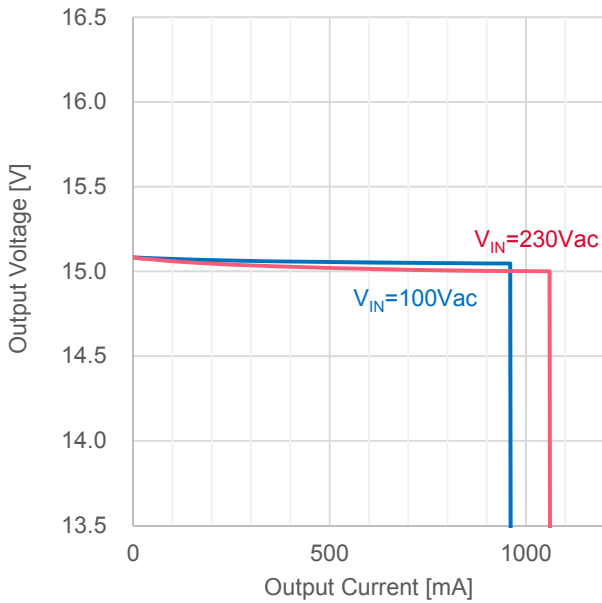

Figure 6. Load Regulation (I_{OUT} vs. V_{OUT})

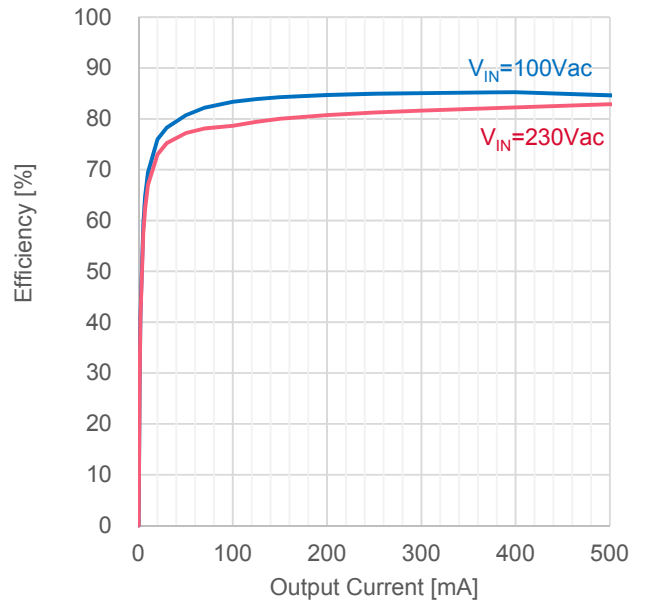

Figure 7. LOAD Regulation (I_{OUT} vs. Efficiency)

Table 2. Load Regulation ($V_{IN}=100Vac$)

Table 3. Load Regulation ($V_{IN}=230Vac$)

I_{OUT}	V_{OUT}	Efficiency
125 mA	15.069 V	83.91 %
250 mA	15.064 V	84.93 %
375 mA	15.059 V	85.21 %
500 mA	15.054 V	84.65 %

I_{OUT}	V_{OUT}	Efficiency
125 mA	15.056 V	79.44 %
250 mA	15.040 V	81.24 %
375 mA	15.029 V	82.08 %
500 mA	15.021 V	82.90 %

· Power Consumption

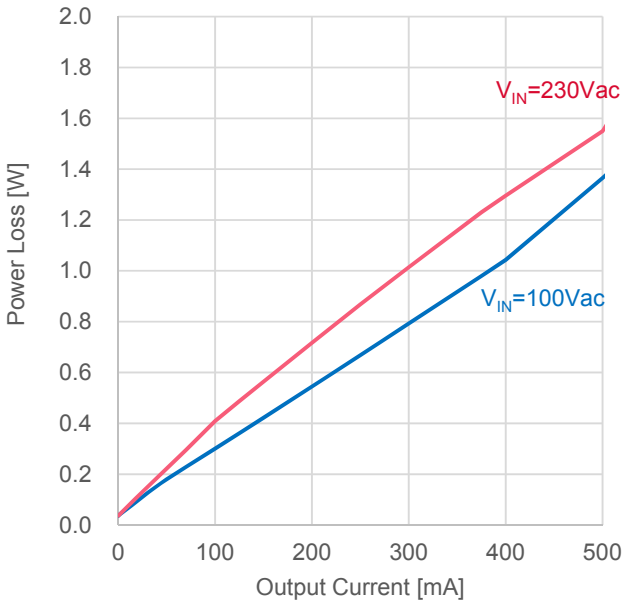

Figure 8. Load Regulation (I_{OUT} vs. P_{LOSS})

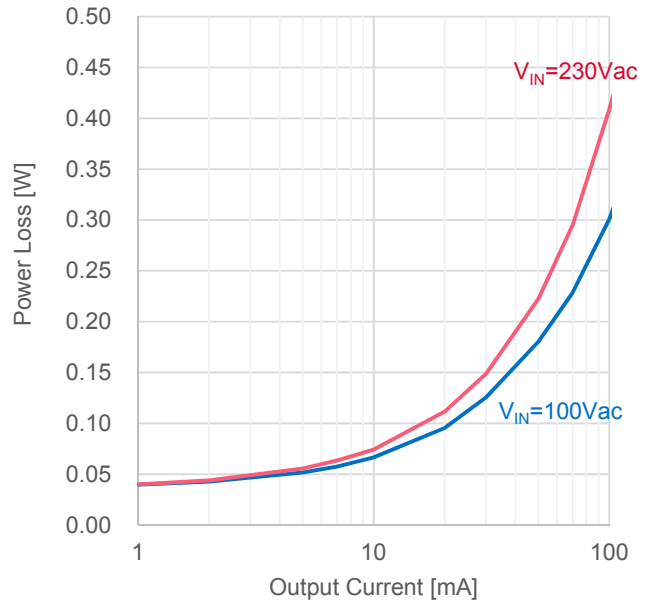

Figure 9. LOAD Regulation (I_{OUT} vs. P_{LOSS})

· Constant AC Line Regulations

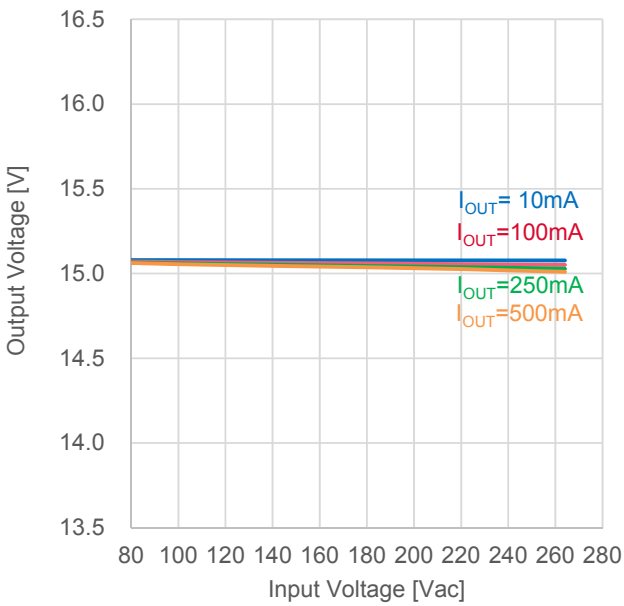

Figure 10. LINE Regulation (I_{OUT} vs. V_{OUT})

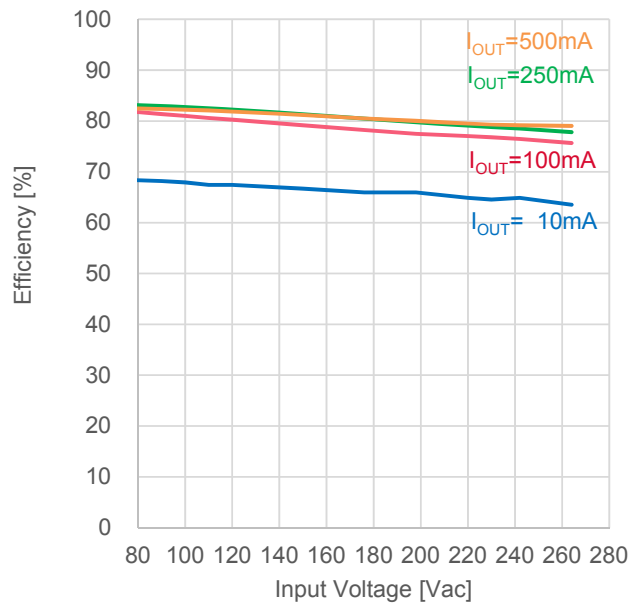

Figure 11. LINE Regulation (I_{OUT} vs. Efficiency)

· Switching Frequency

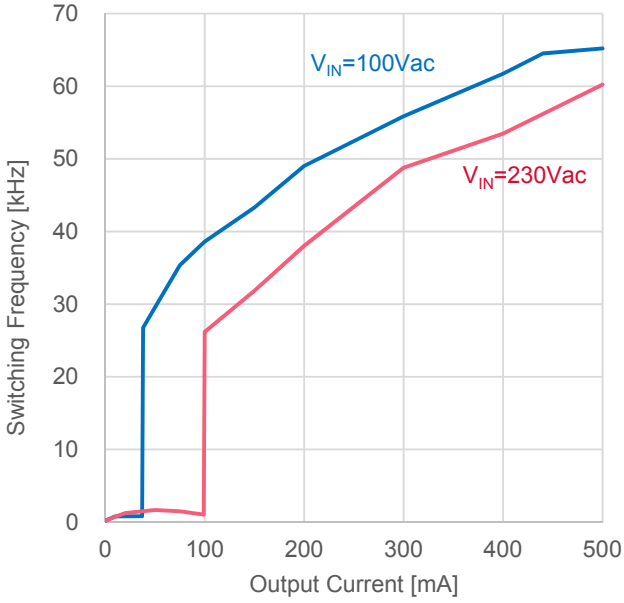

Figure 12. Switching Frequency (I_{OUT} vs. F_{SW})

· Coil Peak Current

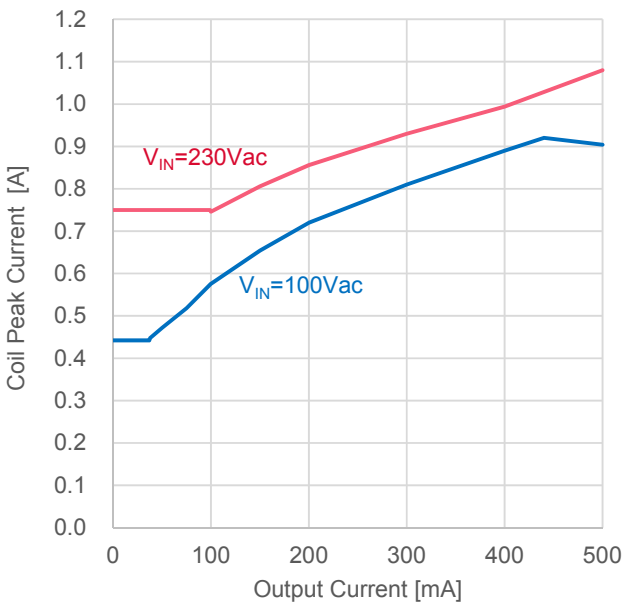

Figure 13. Coil Peak Current (I_{OUT} vs. I_{peak})

· VOUT Ripple Voltage

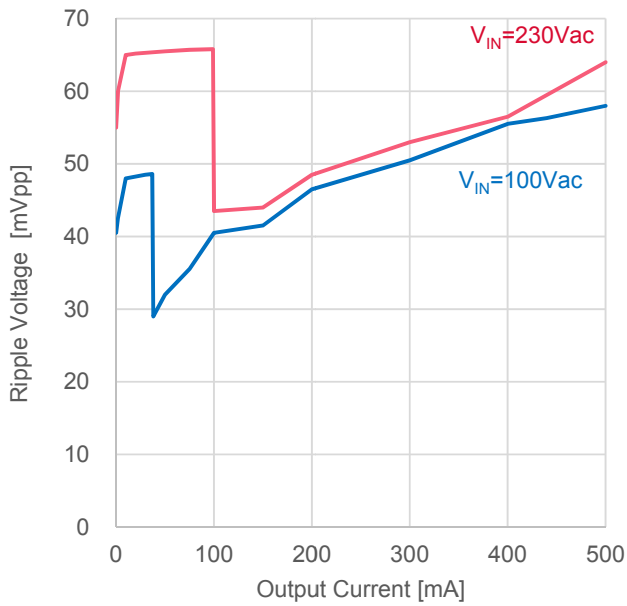

Figure 14. VOUT Ripple Voltage (I_{OUT} vs. V_{ripple})

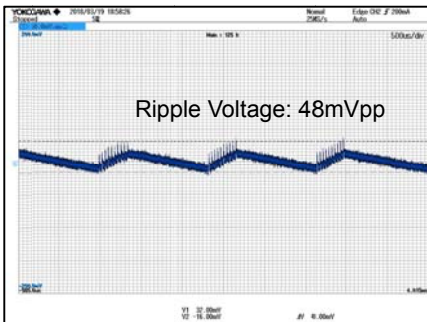

Figure 15. VOUT Ripple Voltage.1
 $V_{IN}=100Vac$, $I_{OUT}=10mA$
 CH1: VOUT 50mV/div, 500μs/div

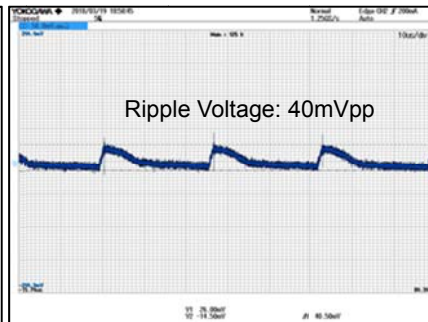

Figure 16. VOUT Ripple Voltage.2
 $V_{IN}=100Vac$, $I_{OUT}=100mA$
 CH1: VOUT 50mV/div, 10μs/div

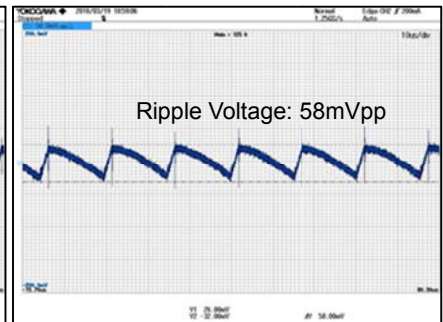

Figure 17. VOUT Ripple Voltage.3
 $V_{IN}=100Vac$, $I_{OUT}=500mA$
 CH1: VOUT 50mV/div, 10μs/div

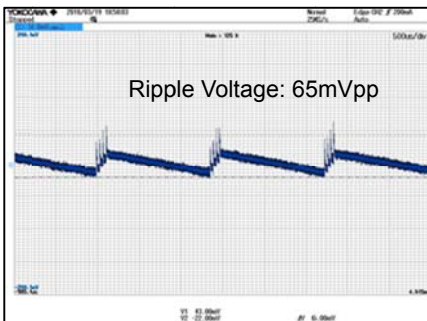

Figure 18. VOUT Ripple Voltage.4
 $V_{IN}=230Vac$, $I_{OUT}=10mA$
 CH1: VOUT 50mV/div, 500μs/div

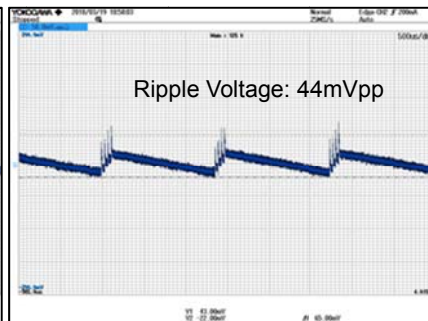

Figure 19. VOUT Ripple Voltage.5
 $V_{IN}=230Vac$, $I_{OUT}=100mA$
 CH1: VOUT 50mV/div, 10μs/div

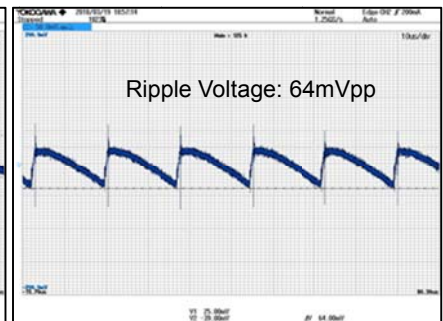

Figure 20. VOUT Ripple Voltage.6
 $V_{IN}=230Vac$, $I_{OUT}=500mA$
 CH1: VOUT 50mV/div, 10μs/div

· Operating Temperature

The Results were measured 30 minutes after startup.

Table 4. Parts surface temperature (Ta: 25°C)

Part	Condition	
	V _{IN} =90Vac, I _{OUT} =0.5A	V _{IN} =264Vac, I _{OUT} =0.5A
IC1	53.5 °C	54.6 °C
D1	61.3 °C	64.0 °C
L1	52.1 °C	57.8 °C

· EMI

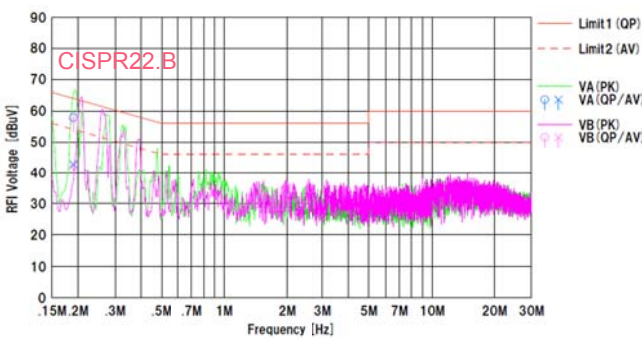

Figure 21. Conducted Emission.1

V_{IN}=110Vac/60Hz, I_{OUT}=0.5A

QP margin= 6.4dB, AV margin=11.1dB

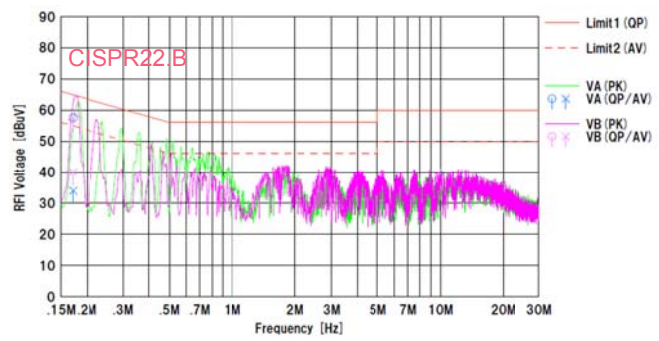

Figure 22. Conducted Emission.2

V_{IN}=230Vac/50Hz, I_{OUT}=0.5A

QP margin= 7.3dB, AV margin=14.9dB

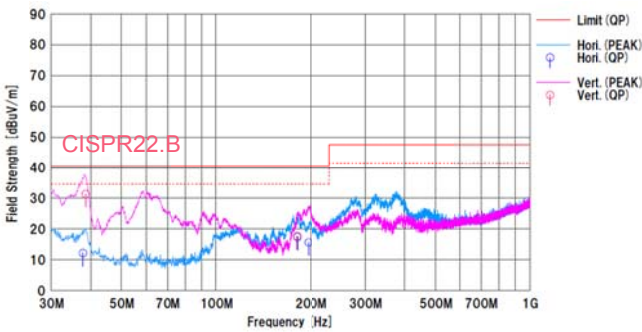

Figure 23. Radiated Emission.1

V_{IN}=110Vac/60Hz, I_{OUT}=0.5A

QP margin=9.2dB, AV margin=11.2dB

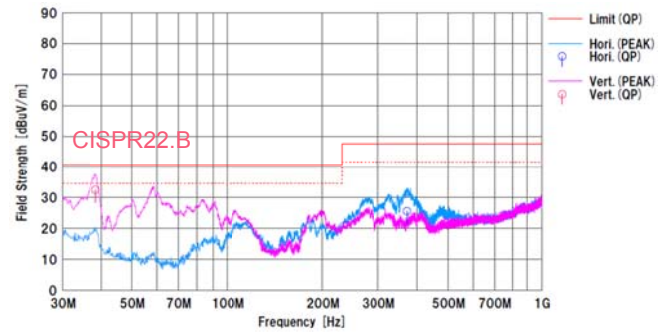

Figure 24. Radiated Emission.2

V_{IN}=230Vac/50Hz, I_{OUT}=0.5A

QP margin= 8.0dB, AV margin=10.4dB

Notes

- 1) The information contained herein is subject to change without notice.
- 2) Before you use our Products, please contact our sales representative and verify the latest specifications :
- 3) Although ROHM is continuously working to improve product reliability and quality, semiconductors can break down and malfunction due to various factors.
Therefore, in order to prevent personal injury or fire arising from failure, please take safety measures such as complying with the derating characteristics, implementing redundant and fire prevention designs, and utilizing backups and fail-safe procedures. ROHM shall have no responsibility for any damages arising out of the use of our Products beyond the rating specified by ROHM.
- 4) Examples of application circuits, circuit constants and any other information contained herein are provided only to illustrate the standard usage and operations of the Products. The peripheral conditions must be taken into account when designing circuits for mass production.
- 5) The technical information specified herein is intended only to show the typical functions of and examples of application circuits for the Products. ROHM does not grant you, explicitly or implicitly, any license to use or exercise intellectual property or other rights held by ROHM or any other parties. ROHM shall have no responsibility whatsoever for any dispute arising out of the use of such technical information.
- 6) The Products specified in this document are not designed to be radiation tolerant.
- 7) For use of our Products in applications requiring a high degree of reliability (as exemplified below), please contact and consult with a ROHM representative : transportation equipment (i.e. cars, ships, trains), primary communication equipment, traffic lights, fire/crime prevention, safety equipment, medical systems, servers, solar cells, and power transmission systems.
- 8) Do not use our Products in applications requiring extremely high reliability, such as aerospace equipment, nuclear power control systems, and submarine repeaters.
- 9) ROHM shall have no responsibility for any damages or injury arising from non-compliance with the recommended usage conditions and specifications contained herein.
- 10) ROHM has used reasonable care to ensure the accuracy of the information contained in this document. However, ROHM does not warrants that such information is error-free, and ROHM shall have no responsibility for any damages arising from any inaccuracy or misprint of such information.
- 11) Please use the Products in accordance with any applicable environmental laws and regulations, such as the RoHS Directive. For more details, including RoHS compatibility, please contact a ROHM sales office. ROHM shall have no responsibility for any damages or losses resulting non-compliance with any applicable laws or regulations.
- 12) When providing our Products and technologies contained in this document to other countries, you must abide by the procedures and provisions stipulated in all applicable export laws and regulations, including without limitation the US Export Administration Regulations and the Foreign Exchange and Foreign Trade Act.
- 13) This document, in part or in whole, may not be reprinted or reproduced without prior consent of ROHM.



Thank you for your accessing to ROHM product informations.
More detail product informations and catalogs are available, please contact us.

ROHM Customer Support System

<http://www.rohm.com/contact/>

Mouser Electronics

Authorized Distributor

Click to View Pricing, Inventory, Delivery & Lifecycle Information:

[ROHM Semiconductor:](#)

[BM2P0161-EVK-001](#)

Компания «Life Electronics» занимается поставками электронных компонентов импортного и отечественного производства от производителей и со складов крупных дистрибьюторов Европы, Америки и Азии.

С конца 2013 года компания активно расширяет линейку поставок компонентов по направлению коаксиальный кабель, кварцевые генераторы и конденсаторы (керамические, пленочные, электролитические), за счёт заключения дистрибьюторских договоров

Мы предлагаем:

- Конкурентоспособные цены и скидки постоянным клиентам.
- Специальные условия для постоянных клиентов.
- Подбор аналогов.
- Поставку компонентов в любых объемах, удовлетворяющих вашим потребностям.
- Приемлемые сроки поставки, возможна ускоренная поставка.
- Доставку товара в любую точку России и стран СНГ.
- Комплексную поставку.
- Работу по проектам и поставку образцов.
- Формирование склада под заказчика.
- Сертификаты соответствия на поставляемую продукцию (по желанию клиента).
- Тестирование поставляемой продукции.
- Поставку компонентов, требующих военную и космическую приемку.
- Входной контроль качества.
- Наличие сертификата ISO.

В составе нашей компании организован Конструкторский отдел, призванный помогать разработчикам, и инженерам.

Конструкторский отдел помогает осуществить:

- Регистрацию проекта у производителя компонентов.
- Техническую поддержку проекта.
- Защиту от снятия компонента с производства.
- Оценку стоимости проекта по компонентам.
- Изготовление тестовой платы монтаж и пусконаладочные работы.



Тел: +7 (812) 336 43 04 (многоканальный)

Email: org@lifeelectronics.ru