

RONDA-S

~25° spot beam with holder A compatible with 3rd party connectors from TE, Bender+Wirth and IDEAL

TECHNICAL SPECIFICATIONS:

Dimensions	Ø 69.9 mm
Height	17.2 mm
Fastening	screw
ROHS compliant	yes ⓘ

MATERIAL SPECIFICATIONS:

Component	Type	Material	Colour	Finish
RONDA-S	Single lens	PMMA	clear	
RONDA-HLD-A	Holder	PC	white	



ORDERING INFORMATION:

Component		Qty in box	MOQ	MPQ	Box weight (kg)
FN15679_RONDA-S	Single lens	420	120	30	0.0
» Box size:					

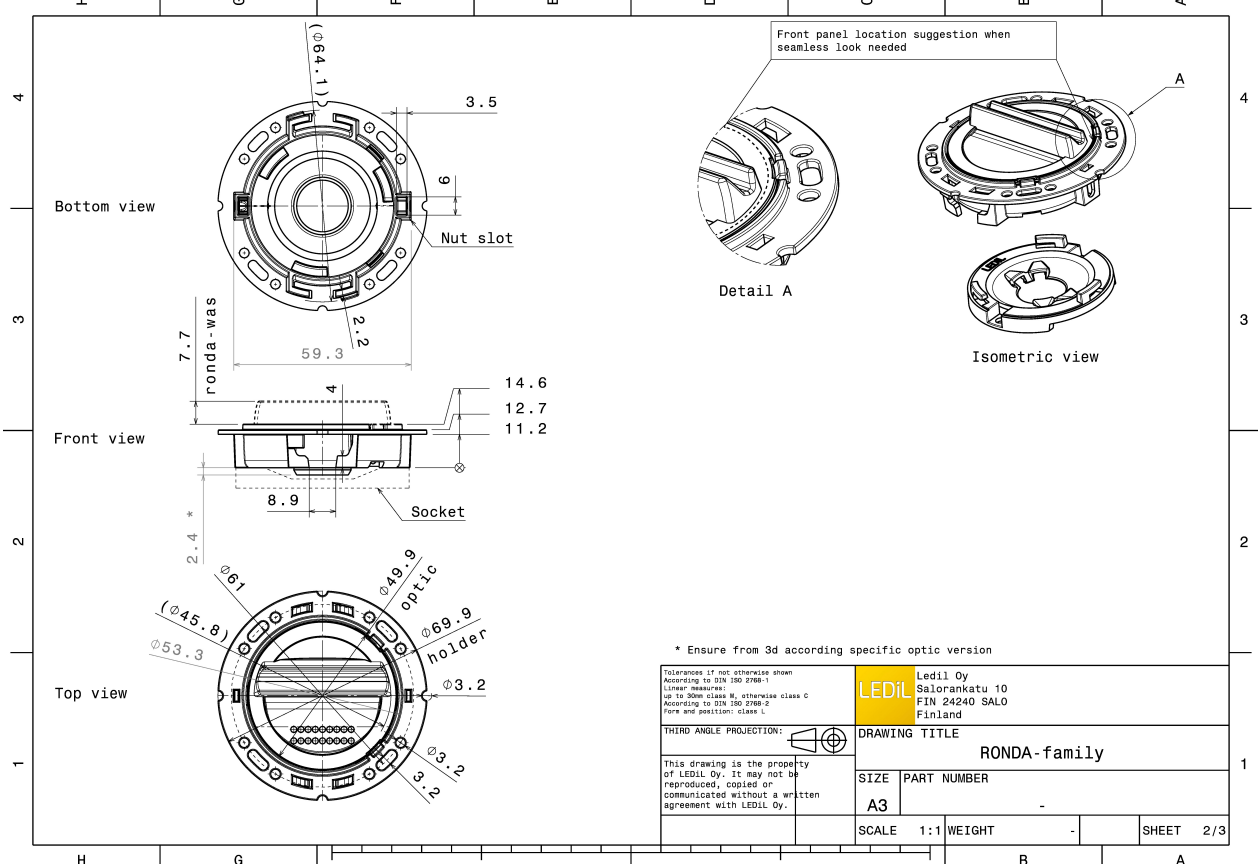
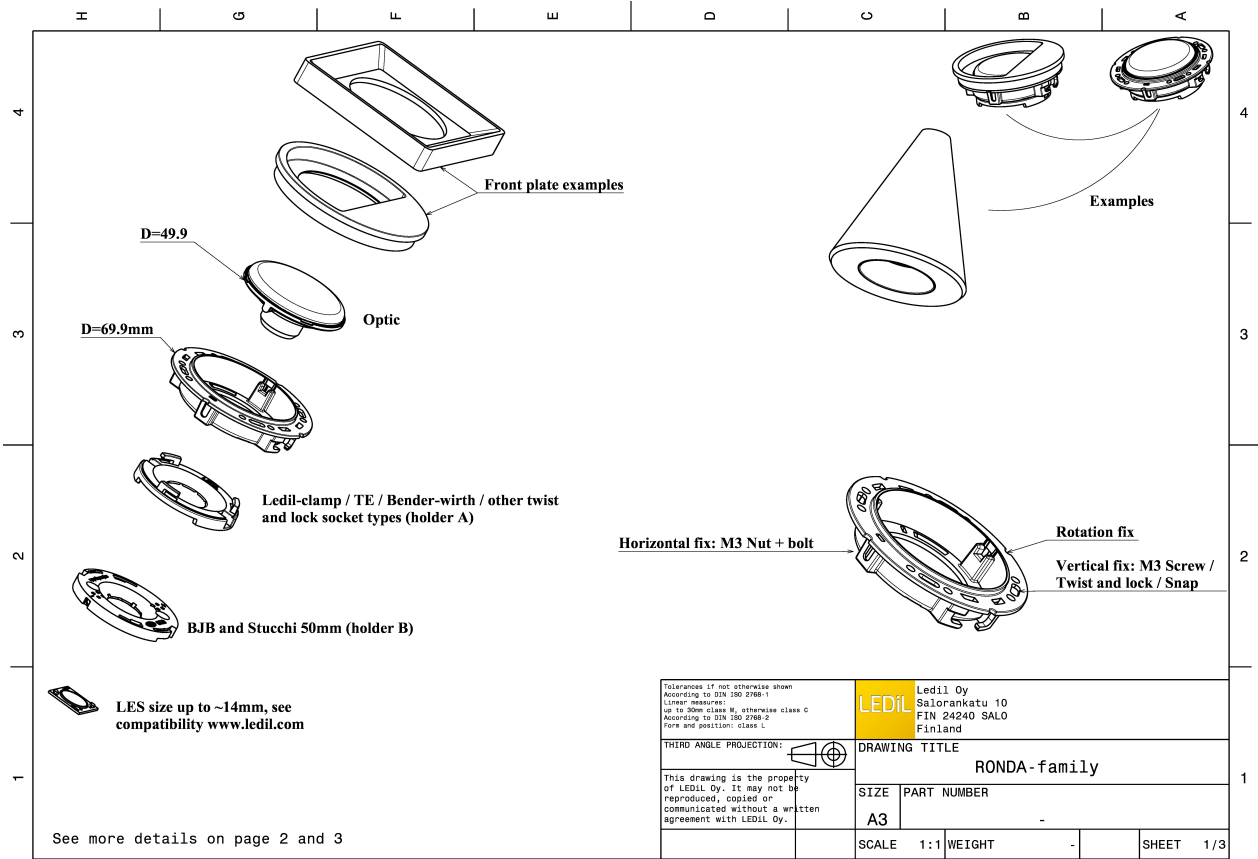

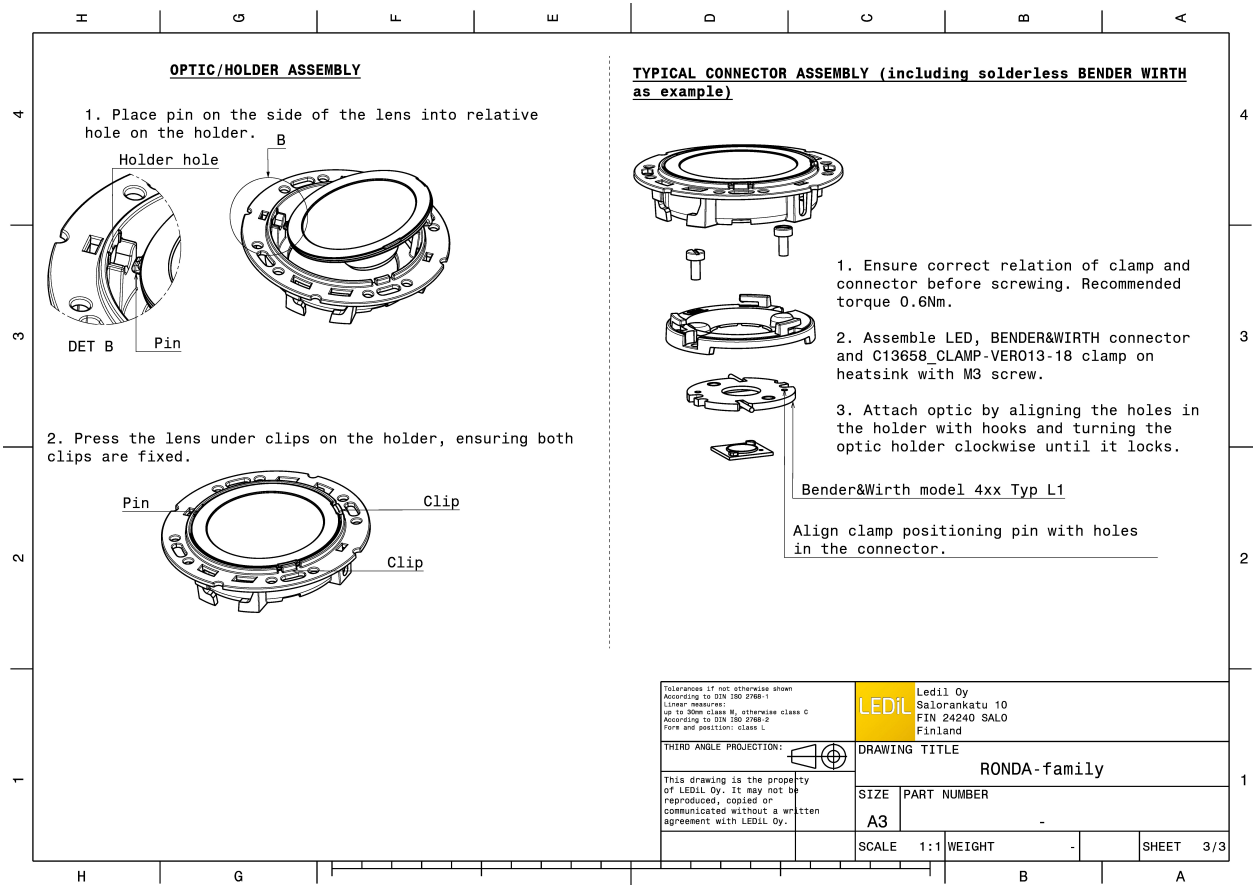

PHOTOMETRIC DATA (MEASURED):

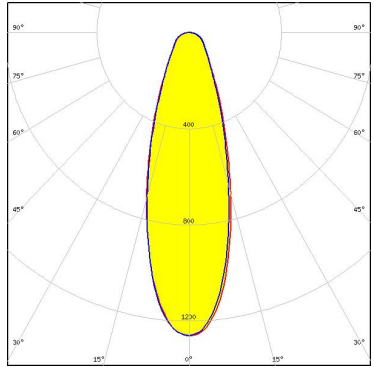
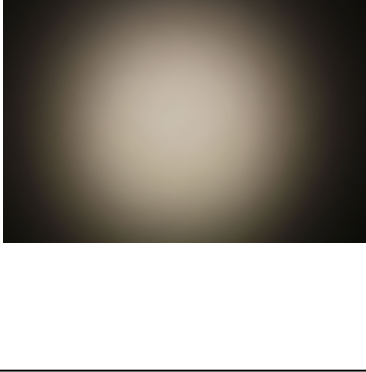
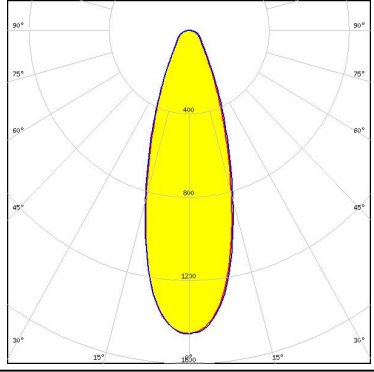
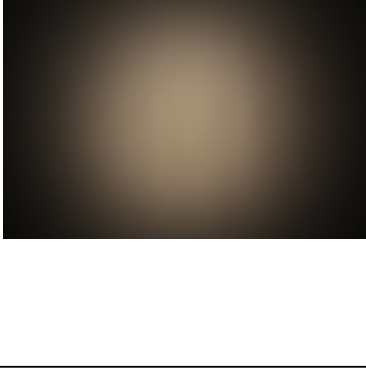
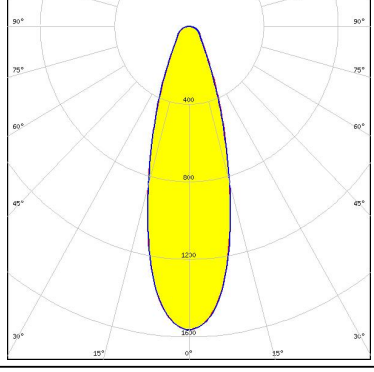
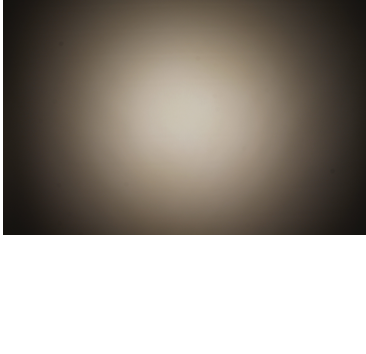
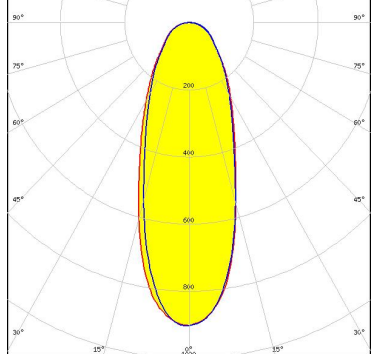
<p>bridgelux.</p> <p>LED V13 Gen7 FWHM 32.0° Efficiency 80 % Peak intensity 1.3 cd/lm LEDs/each optic 1 Light colour White Required components: TE: 2213254-2 + OPTIC CLIP Z50 TYPE1 2213194-1</p>		
<p>bridgelux.</p> <p>LED Vero SE 13 FWHM 33.0° Efficiency 86 % Peak intensity 1.5 cd/lm LEDs/each optic 1 Light colour White Required components: C16402_CLAMP-VEROSE-13-18</p>		
<p>bridgelux.</p> <p>LED VERO13 FWHM 32.0° Efficiency 87 % Peak intensity 1.6 cd/lm LEDs/each optic 1 Light colour White Required components: C13658_CLAMP-VERO13-18</p>		
<p>bridgelux.</p> <p>LED VERO18 FWHM 39.0° Efficiency 81 % Peak intensity 0.9 cd/lm LEDs/each optic 1 Light colour White Required components: C13658_CLAMP-VERO13-18</p>		

PHOTOMETRIC DATA (MEASURED):

CITIZEN

LED CLL03x/CLU03x
 FWHM 33.0°
 Efficiency 83 %
 Peak intensity 1.2 cd/lm
 LEDs/each optic 1
 Light colour White
 Required components:
 C16791_CLAMP-Z45-A
 TE: 2325807-3

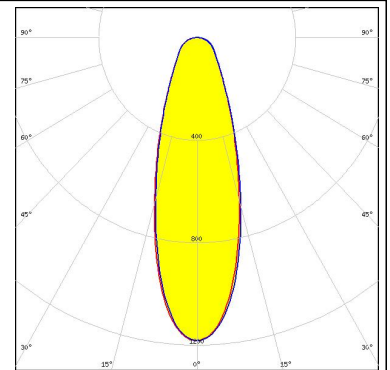
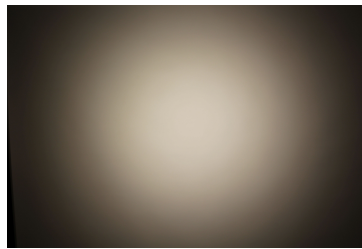

CREE

LED CMA1840
 FWHM 38.0°
 Efficiency 88 %
 Peak intensity 1.3 cd/lm
 LEDs/each optic 1
 Light colour White
 Required components:
 C14123_CLAMP-CXA15-18

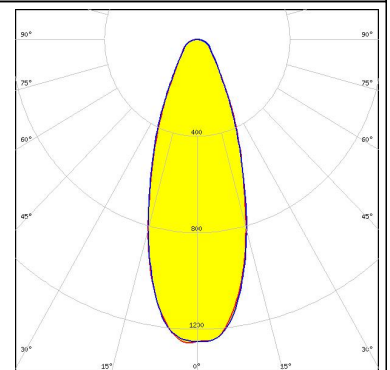
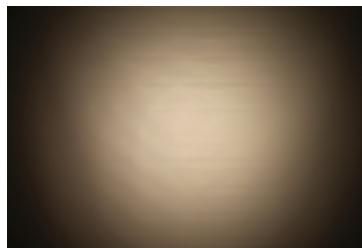

CREE

LED CXA/B 1816 & CXA/B 1820 & CXA 1850
 FWHM 33.0°
 Efficiency 88 %
 Peak intensity 1.5 cd/lm
 LEDs/each optic 1
 Light colour White
 Required components:
 C14123_CLAMP-CXA15-18

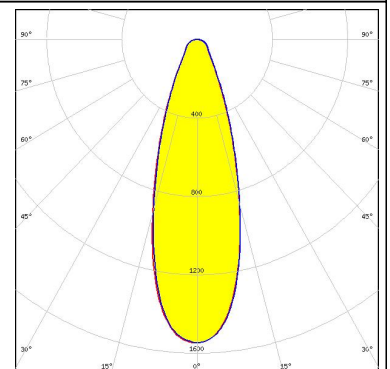
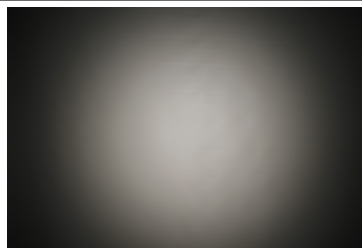

CREE

LED CXA/B 1816 & CXA/B 1820 & CXA 1850
 FWHM 31.0°
 Efficiency 83 %
 Peak intensity 1.5 cd/lm
 LEDs/each optic 1
 Light colour White
 Required components:
 TE: 2213401-2 + OPTIC CLIP Z50 TYPE1 2213194-1

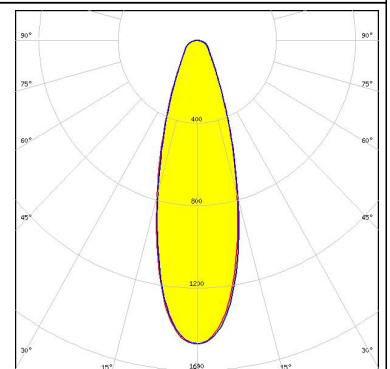
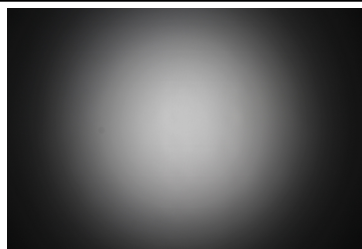

PHOTOMETRIC DATA (MEASURED):

OSRAM

LED PrevaLED Core G7 L15 H1
 FWHM 35.0°
 Efficiency 82 %
 Peak intensity 1.1 cd/lm
 LEDs/each optic 1
 Light colour White
 Required components:
 C16685_CLAMP-PRV-A

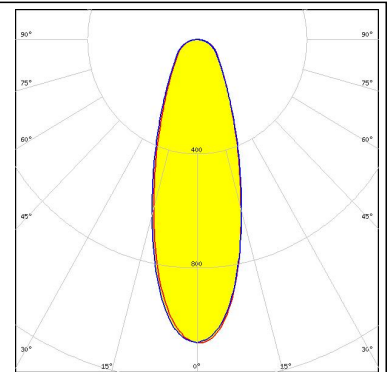
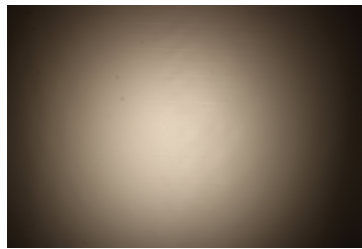

PHILIPS

LED Fortimo SLM L13 CoB
 FWHM 34.0°
 Efficiency 81 %
 Peak intensity 1.4 cd/lm
 LEDs/each optic 1
 Light colour White
 Required components:
 TE: 2213130-2 + OPTIC CLIP Z50 TYPE1 2213194-1

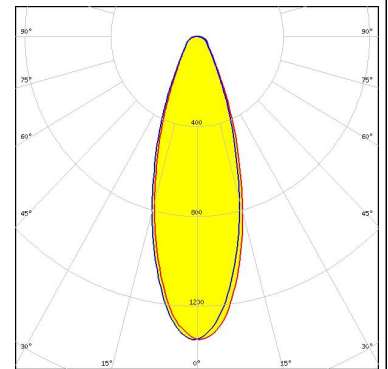
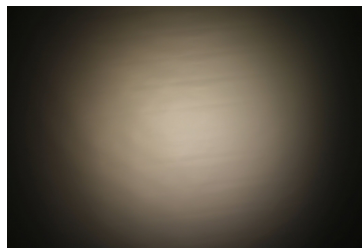

PHILIPS

LED Fortimo SLM L15 + SLM holder
 FWHM 34.0°
 Efficiency 79 %
 Peak intensity 1.1 cd/lm
 LEDs/each optic 1
 Light colour White
 Required components:

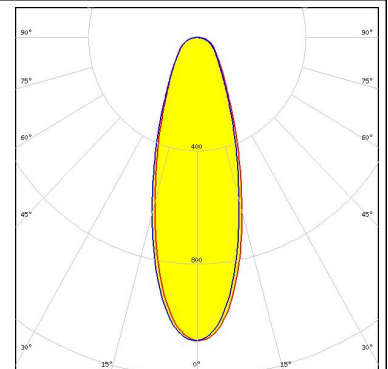
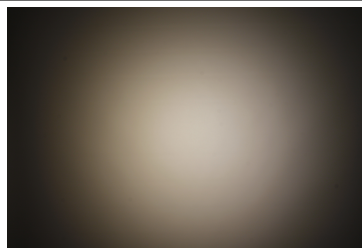

SEOL SEMICONDUCTOR



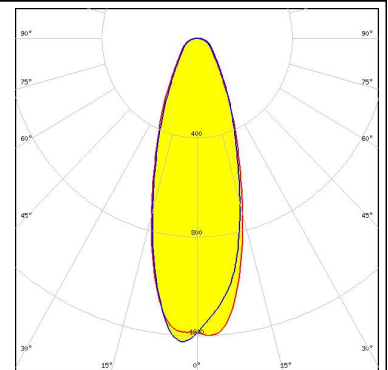
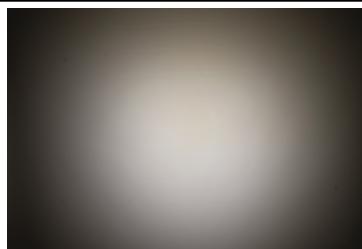

LED AC Zhaga COB
 FWHM 36.0°
 Efficiency 83 %
 Peak intensity 1.2 cd/lm
 LEDs/each optic 1
 Light colour White
 Required components:
 Optosource: SEHSMJD-A



PHOTOMETRIC DATA (MEASURED):

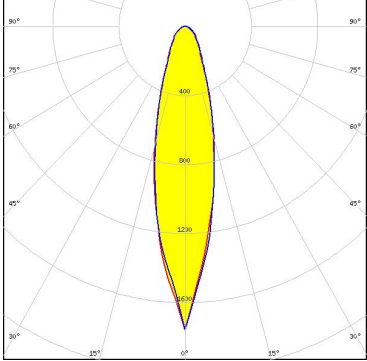
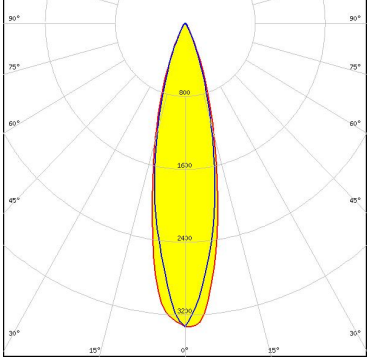

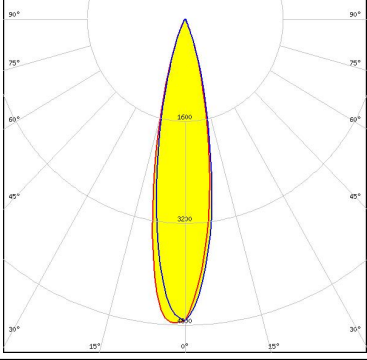
PHOTOMETRIC DATA (SIMULATED):

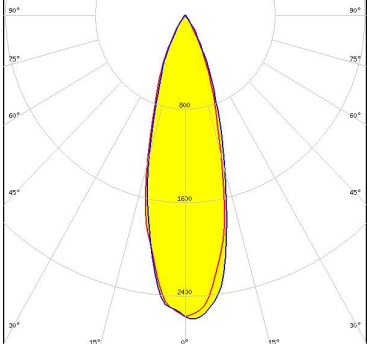
<p> bridgelux</p> <p>LED V13 Gen7 FWHM 24.0° Efficiency 73 % Peak intensity 1.8 cd/lm LEDs/each optic 1 Light colour White Required components: IDEAL: 50-2103CT + 50-2100AN</p>	
<p>CITIZEN</p> <p>LED CLL02x/CLU02x (LES10) FWHM 25.0° Efficiency 86 % Peak intensity 3.4 cd/lm LEDs/each optic 1 Light colour White Required components: C13658_CLAMP-VERO13-18</p>	
<p> CREE</p> <p>LED CXA/B 15xx FWHM 22.0° Efficiency 89 % Peak intensity 4.9 cd/lm LEDs/each optic 1 Light colour White Required components: C13658_CLAMP-VERO13-18</p>	
<p> CREE</p> <p>LED CXA/B 1816 & CXA/B 1820 & CXA 1850 FWHM 29.0° Efficiency 85 % Peak intensity 2.6 cd/lm LEDs/each optic 1 Light colour White Required components: C14123_CLAMP-CXA15-18</p>	

PHOTOMETRIC DATA (SIMULATED):

OSRAM
Opto Semiconductors

LED Duris S10
FWHM 17.0°
Efficiency 87 %
Peak intensity 6.2 cd/lm
LEDs/each optic 1
Light colour White
Required components:
C13658_CLAMP-VERO13-18

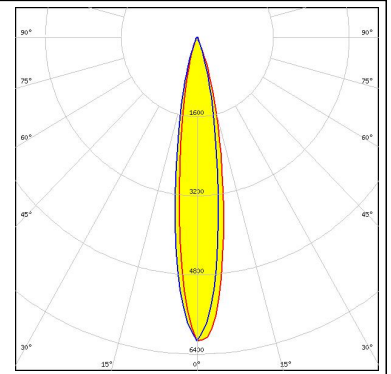

GENERAL INFORMATION:

NOTE: The typical beam angle will be changed by different color, chip size and chip position tolerance. The typical total beam angle is the full angle measured where the luminous intensity is half of the peak value.

Due to use of high power COB's with this product, special attention to proper thermal design is highly recommended. LEDiL has no liability for direct, indirect or consecutive damages arising from the LEDiL products being used outside of the recommended temperature range.

MATERIALS:

As part of our continuous research and improvement processes, and to ensure the best possible quality and availability of our products, LEDiL reserves the right to change material grades without notice.

PRODUCT DATA USER AGREEMENT AND DISCLAIMER:

The measured data in the provided downloadable LEDiL Product Datasheets and Mechanical 2D-Drawings is rounded and provided as reference for planning. LEDiL Oy's optical specifications have been verified by conducting performance testing of the products in accordance with the company's quality system. The reported data are averaged results of multiple measurements with typical variation. LEDiL Oy reserves the right to without prior notification make changes and improvements to its products.

LEDiL Oy assumes neither warranty, nor guarantee nor any other liability of any kind for the contents and correctness of the provided data. The provided data has been generated with highest diligence but the provided data may in reality not represent the complete possible variation range of all intrinsic parameters. Therefore, in certain cases a deviation from the provided data could occur.

LEDiL Oy reserves the right to undertake technical changes of its products without further notification which could lead to changes in the provided data. LEDiL Oy assumes no liability of any kind for the possible deviation from any provided data or any other damage resulting from the usage of the provided data.

The user agrees to this disclaimer and user agreement with the download or usage of the provided files.

LEDiL Oy

Joensuunkatu 13
FI-24240 SALO
Finland

LEDiL Inc.

228 West Page Street
Suite D
Sycamore IL 60178
USA

Local sales and technical support

[www.ledil.com/
where_to_buy](http://www.ledil.com/where_to_buy)

Shipping locations

Salo, Finland
Hong Kong, China

Distribution Partners

[www.ledil.com/
where_to_buy](http://www.ledil.com/where_to_buy)

Компания «Life Electronics» занимается поставками электронных компонентов импортного и отечественного производства от производителей и со складов крупных дистрибьюторов Европы, Америки и Азии.

С конца 2013 года компания активно расширяет линейку поставок компонентов по направлению коаксиальный кабель, кварцевые генераторы и конденсаторы (керамические, пленочные, электролитические), за счёт заключения дистрибьюторских договоров

Мы предлагаем:

- Конкурентоспособные цены и скидки постоянным клиентам.
- Специальные условия для постоянных клиентов.
- Подбор аналогов.
- Поставку компонентов в любых объемах, удовлетворяющих вашим потребностям.
- Приемлемые сроки поставки, возможна ускоренная поставка.
- Доставку товара в любую точку России и стран СНГ.
- Комплексную поставку.
- Работу по проектам и поставку образцов.
- Формирование склада под заказчика.
- Сертификаты соответствия на поставляемую продукцию (по желанию клиента).
- Тестирование поставляемой продукции.
- Поставку компонентов, требующих военную и космическую приемку.
- Входной контроль качества.
- Наличие сертификата ISO.

В составе нашей компании организован Конструкторский отдел, призванный помогать разработчикам, и инженерам.

Конструкторский отдел помогает осуществить:

- Регистрацию проекта у производителя компонентов.
- Техническую поддержку проекта.
- Защиту от снятия компонента с производства.
- Оценку стоимости проекта по компонентам.
- Изготовление тестовой платы монтаж и пусконаладочные работы.



Тел: +7 (812) 336 43 04 (многоканальный)
Email: org@lifeelectronics.ru