

## SPECIFICATION

- Part No. : **CA.69**
- Product Name : 169 MHz VHF Ceramic Chip Monopole Antenna
- Feature : 25.2mm \* 5.1mm \* 0.8mm  
Efficiency 10~15% (on evaluation board)  
Peak Gain - approx -7 dBi (on evaluation board)  
Low profile
- Compact Size  
RoHS Compliant



## 1. Introduction

The CA.69 Ceramic Chip antenna from Taoglas 169 MHz is specifically designed for VHF 169MHz band applications. It is a high efficiency miniature SMD edge mounted antenna with small footprint requirement. This chip antenna uses the main PCB as its ground plane, thereby increasing antenna efficiency. It is tuned for different PCB sizes by simply changing the value of the matching circuit. CA.69 antenna electrical properties are symmetrical therefore the antenna can be soldered to the board from either side.

This antenna is delivered on tape and reel. Small low frequency antennas such as CA.69 need to be carefully tuned and integrated into devices to perform optimally given the narrow band tuning required, so contact your regional Taoglas sales office for support on gerber review of your layout, advice on ground-plane layout and transmission line design. Taoglas also recommends we test your final device prototype with CA.69 on board and provide final matching values.

Taoglas has tested the CA.69 mounted in realistic conditions in metal or semi metal meter housings with the latest high power modules from Telit and achieved read ranges of more than one hundred metres.

## Applications

VHF Band Applications

## 2. Specification Table

Electrical	
Center Frequency (MHz)	169
Bandwidth (MHz)	8 (under -10dB Return Loss)
VSWR	2 max.
Impedance ( $\Omega$ )	50 $\Omega$
Polarization	Linear
MECHANICAL	
Dimensions (mm)	25.2*5.1*0.8
Ground plane (mm)	110*55mm
ENVIRONMENTAL	
Temperature Range	-40°C to 85°C
Relative Humidity	20% to 70%

### 3. Return Loss

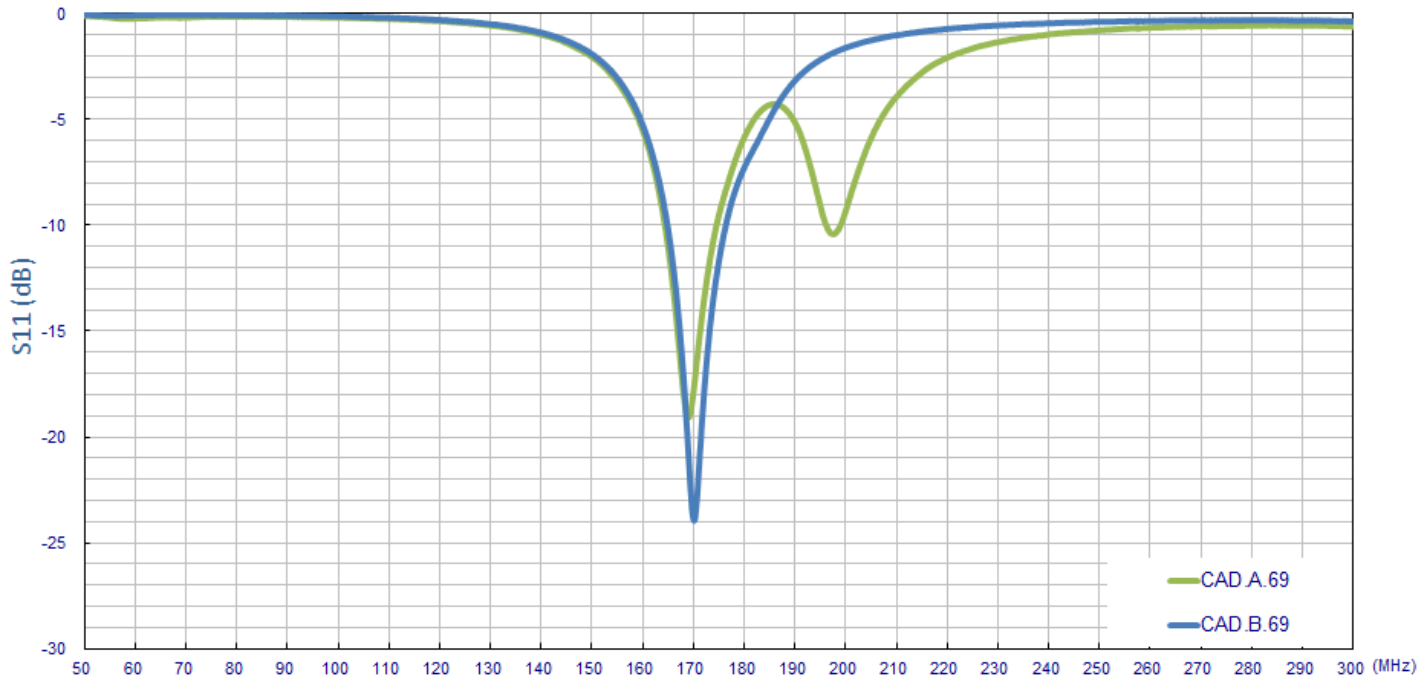

\*The antenna tuning depends on different antenna ground plane application. Taoglas provides CAD.A.69 and CAD.B.69 evaluation boards to show performance when antenna is parallel mounted to the ground plane or when it is orthogonally mounted to the ground-plane.

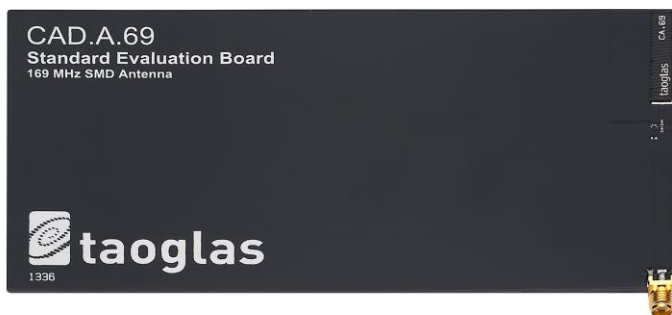

## 4. Antenna Characteristics

Antenna Efficiency

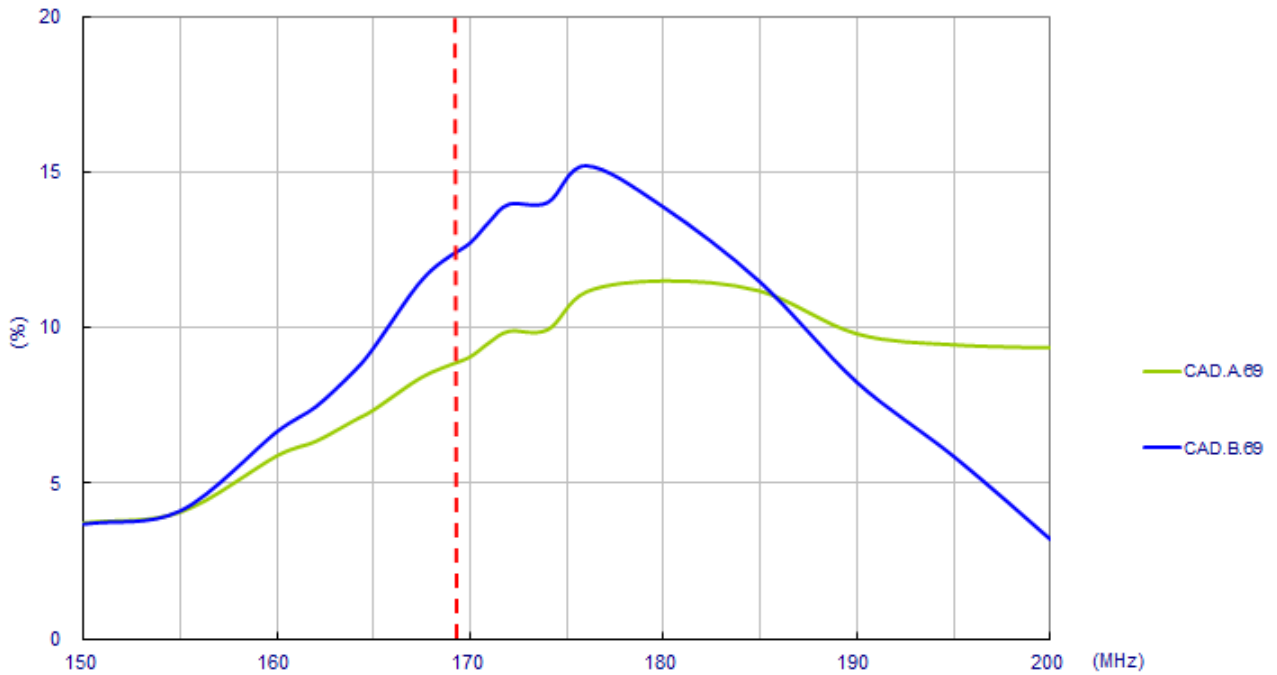

Antenna Peak Gain

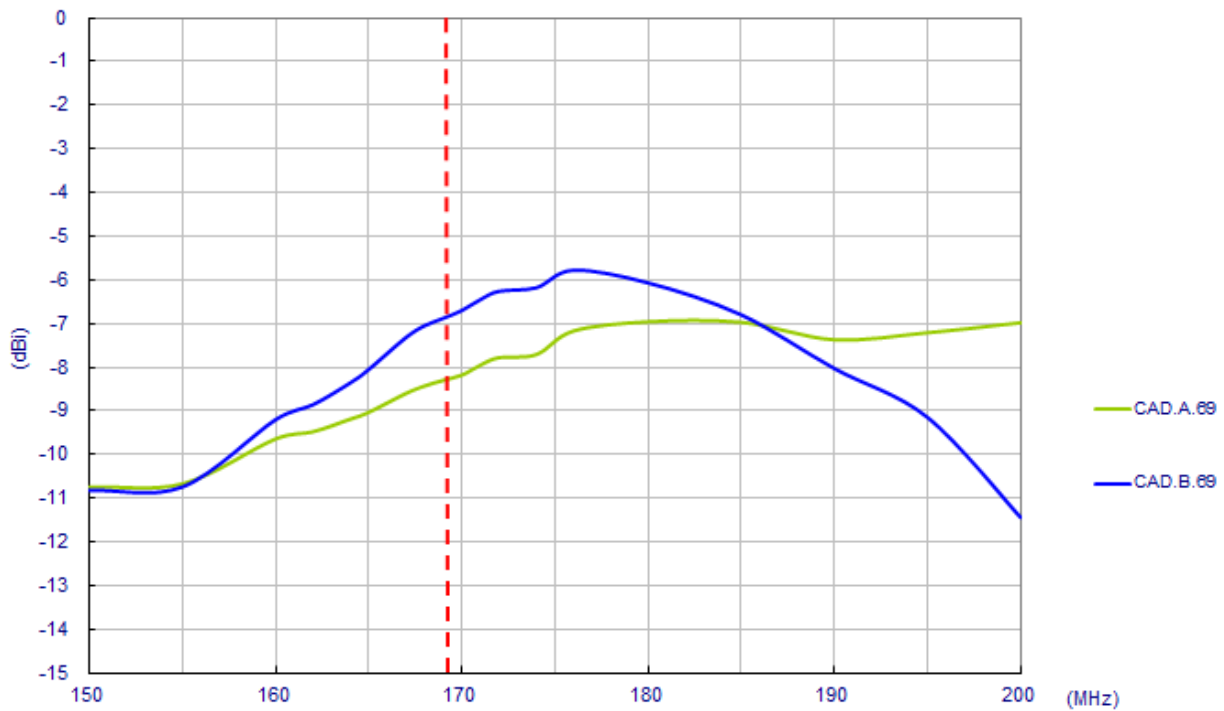

# 5. Antenna Radiation Pattern

CAD.A.69

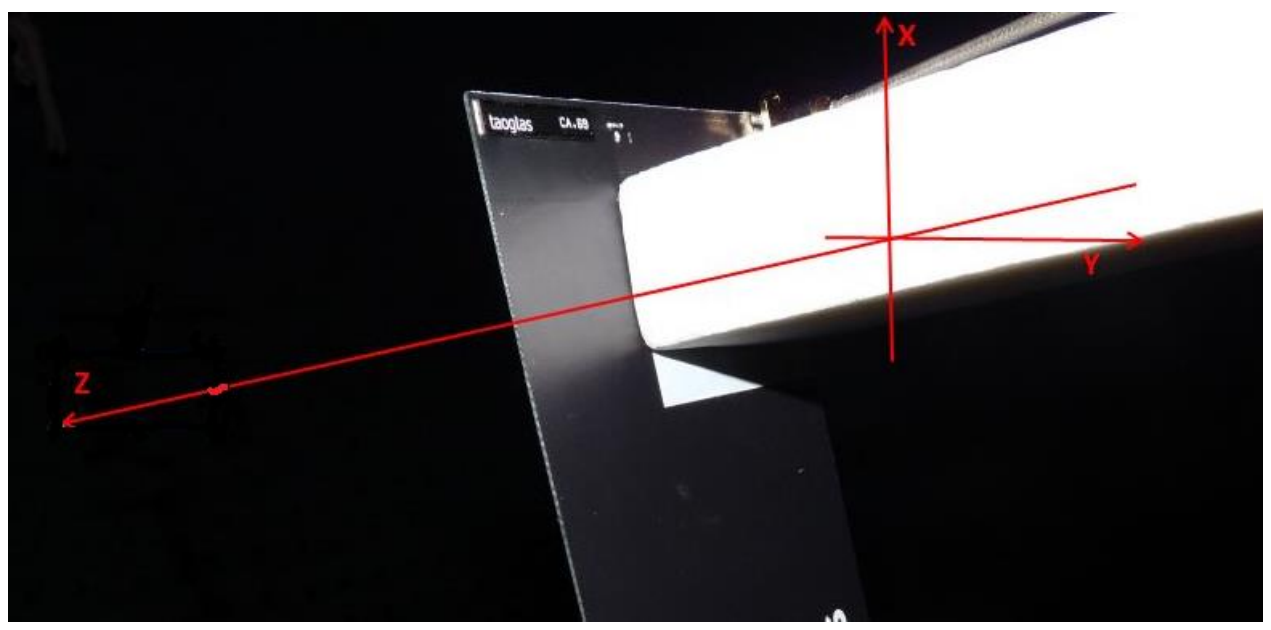

XY-Plane

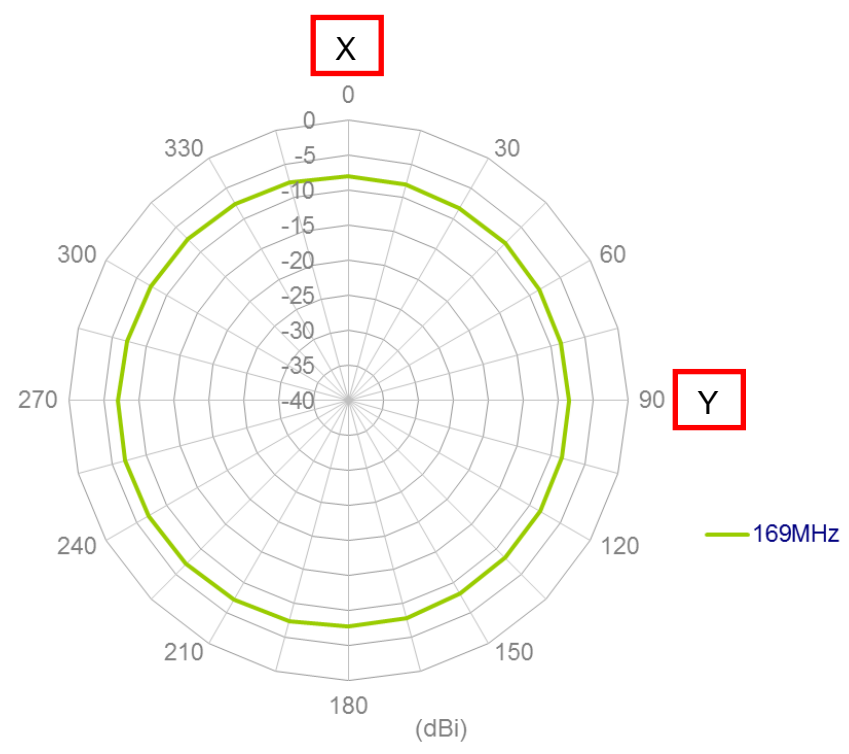

XZ-Plane

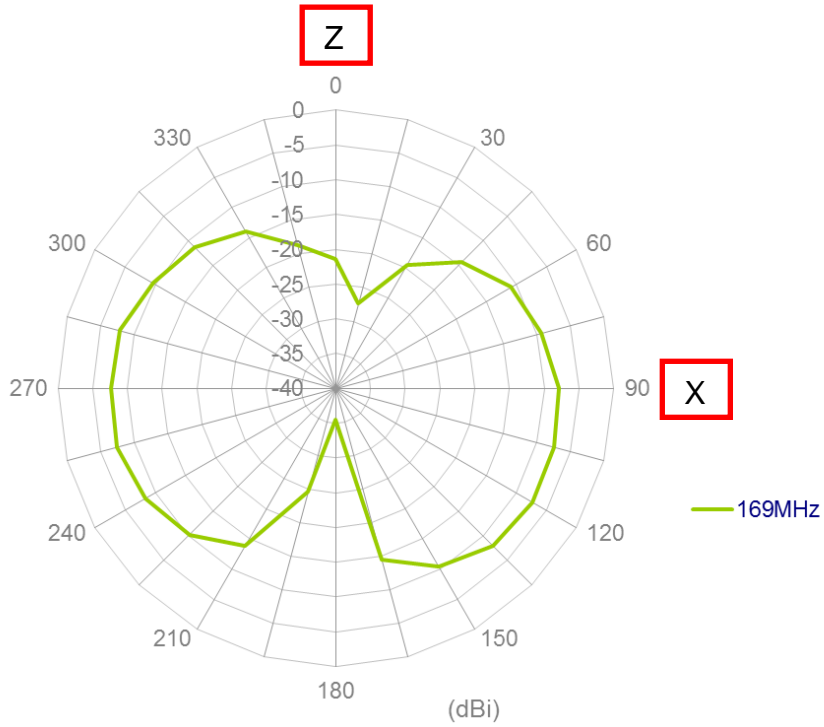

YZ-Plane

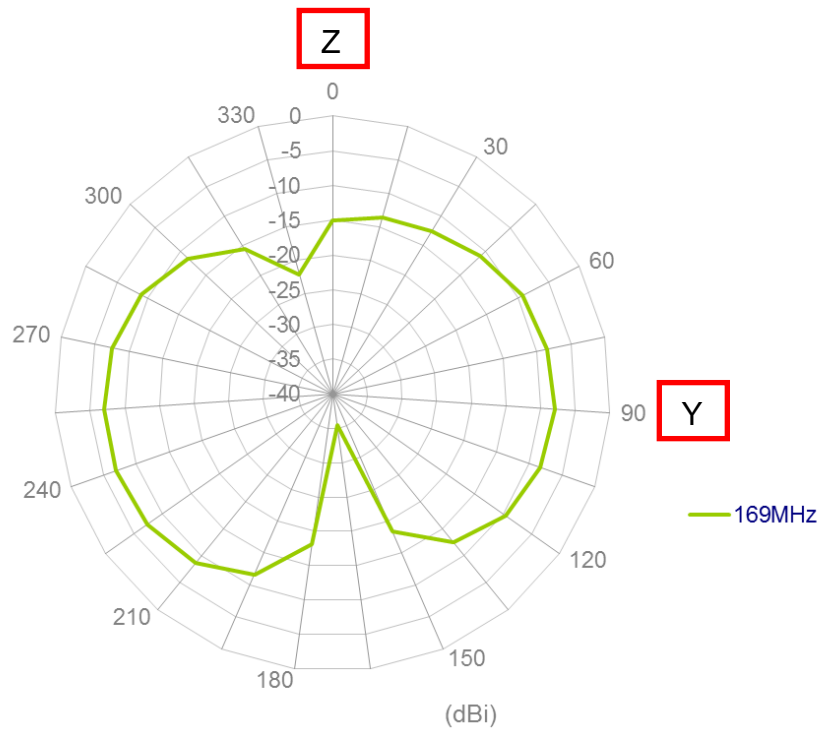

CAD.B.69

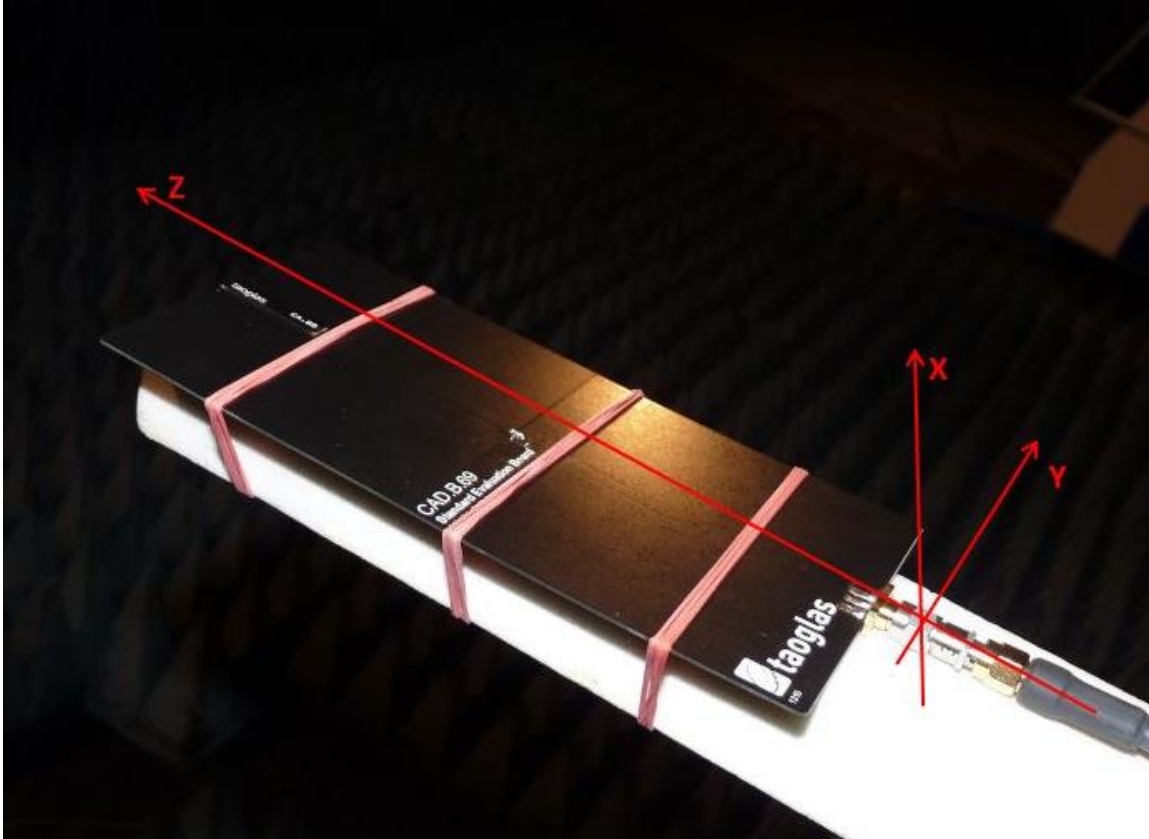

XY-Plane

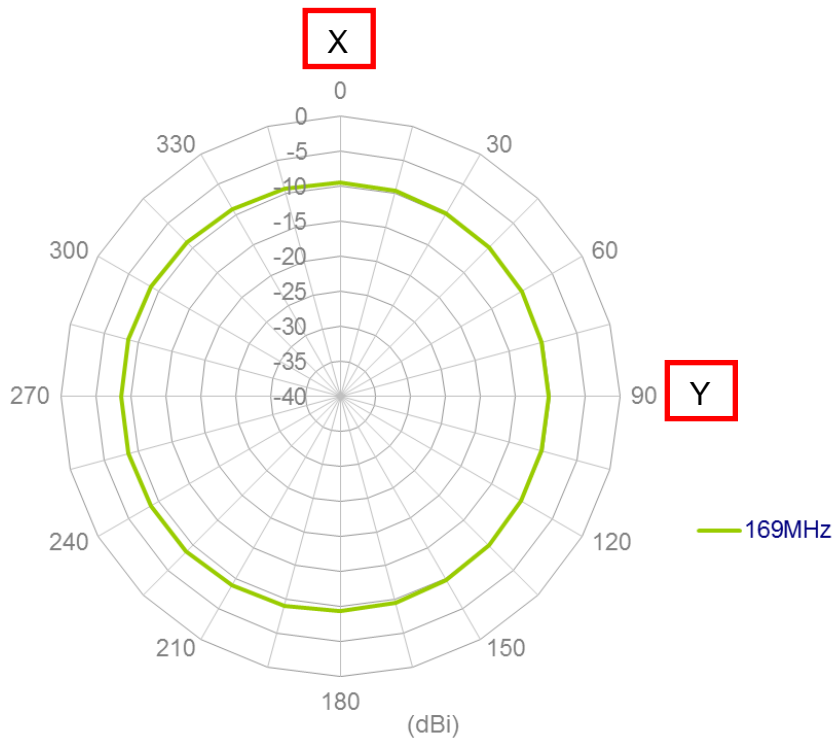



XZ-Plane

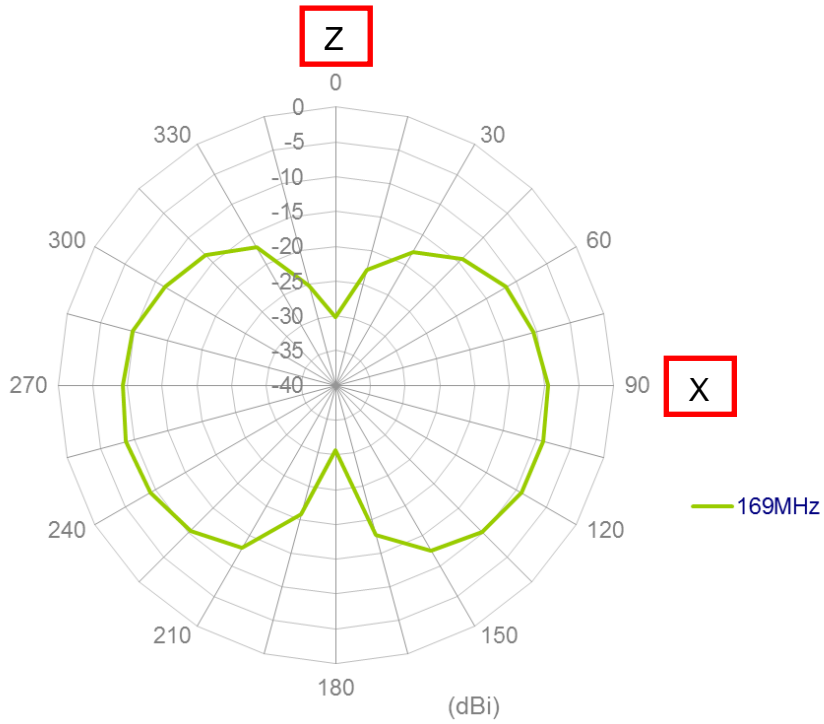

YZ-Plane

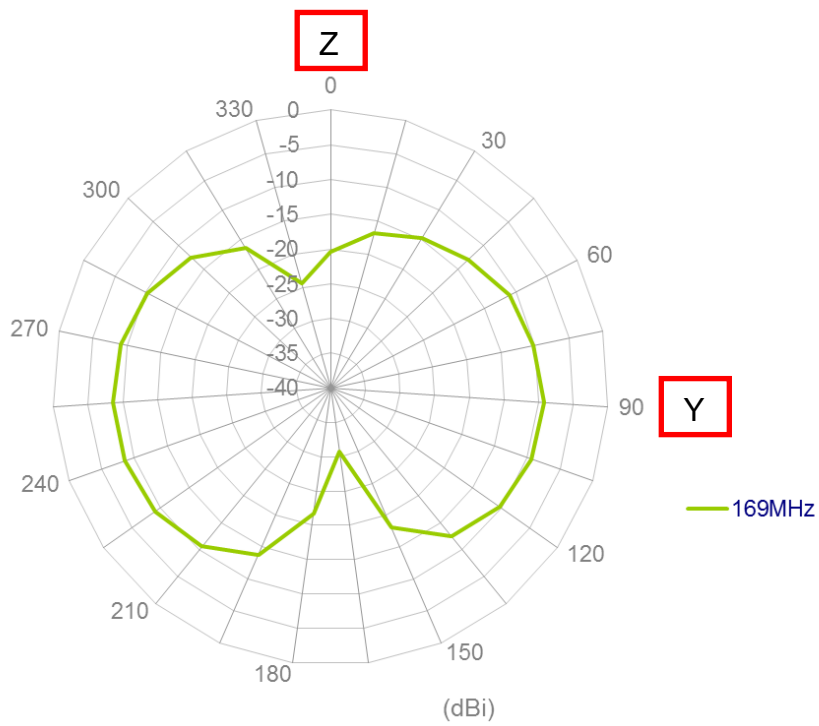

## 6. Mechanical Drawing

Antenna Main Body

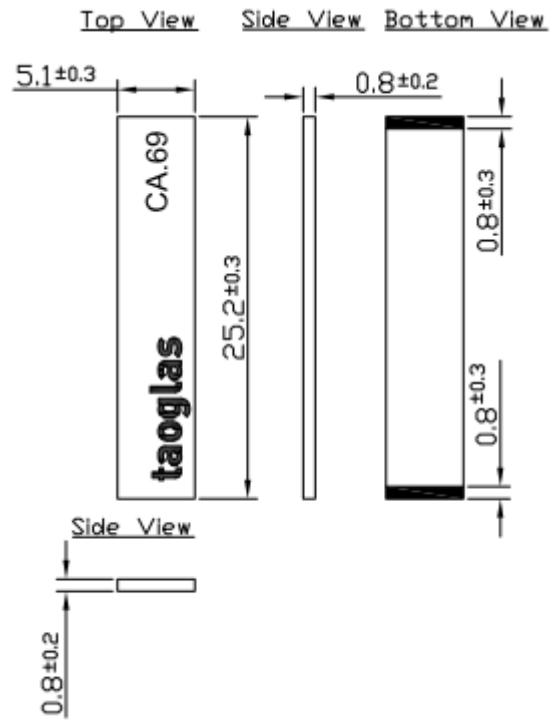

CAD.A.69 Application

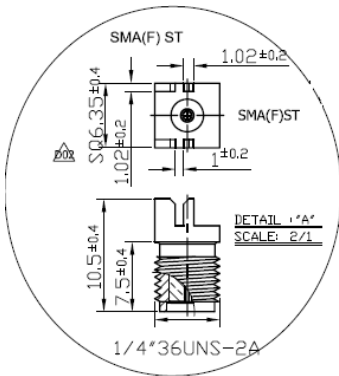
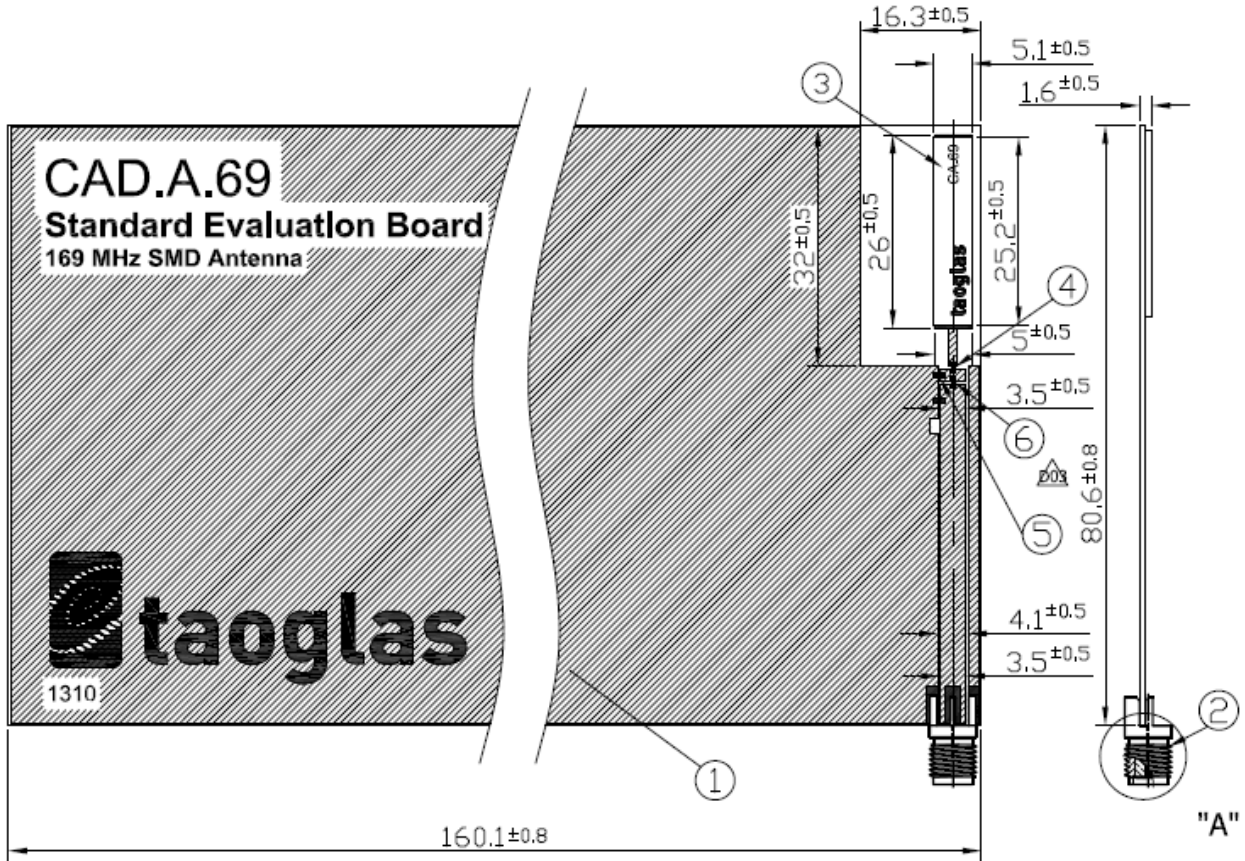

	Name	P/N	Material	Finish	QTY
1	CAD.A.69 EVB PCB	100213E010012A	FR4 0,8t	Black	1
2	SMA(F) ST	200413H000002A	Brass	Gold	1
3	CA.69 Antenna	001513E020012A	FR4 0,8t	Black	1
4	Inductor (L=300nH) 0402	001513G020055A	Ceramic	N/A	D04 1
5	Capacitor (C=1pF) 0402	001513G010055A	Ceramic	N/A	1
6	Inductor (L=270nH) 0402	001513J000055A	Ceramic	N/A	1

### CAD.B.69 Application

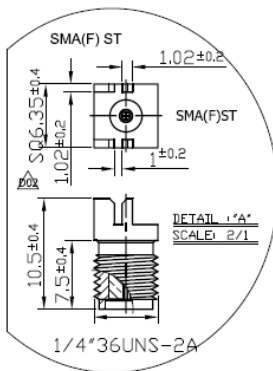
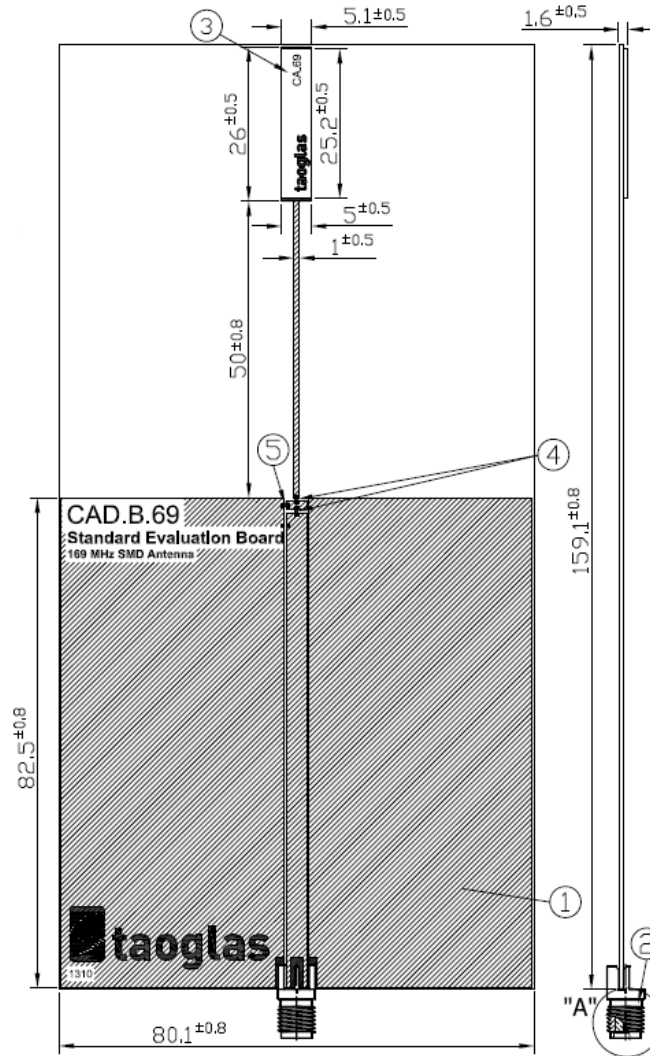

	Name	P/N	Material	Finish	QTY
1	CAD.B.69 EVB PCB	100213E000012A	FR4 0,8t	Black	1
2	SMA(F) ST	200413H000002A	Brass	Gold	1
3	CA.69 Antenna	001513E020012A	FR4 0,8t	Black	1
4	Inductor (L=220nH) 0402	001513G030055A	Ceramic	N/A	2
5	Capacitor (C=1pF) 0402	001513G010055A	Ceramic	N/A	1

## 7. Layout Guide

Solder Land Pattern:

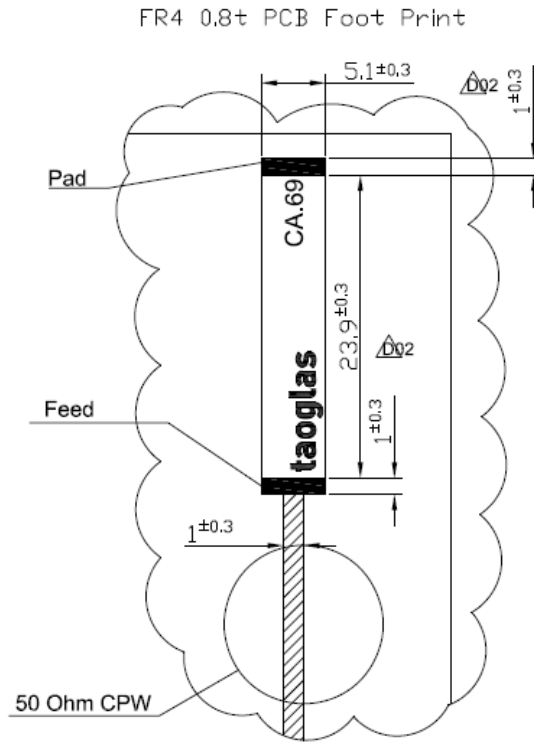

Matching circuit:

CAD.A.69

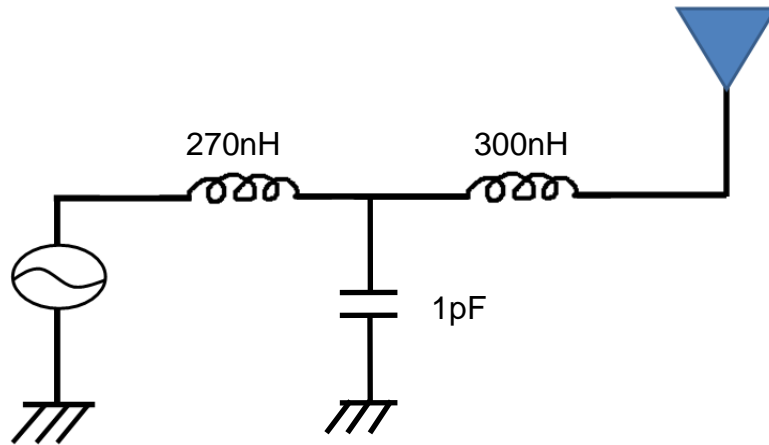

CAD.B.69

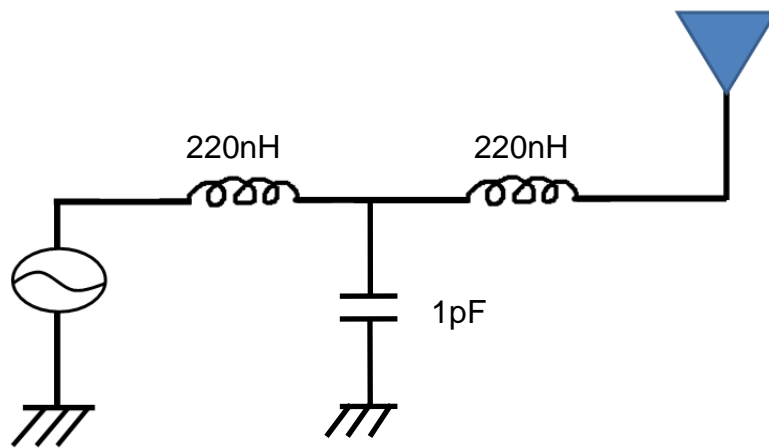

## 8. Soldering Conditions

Typical Soldering profile for lead-free process:

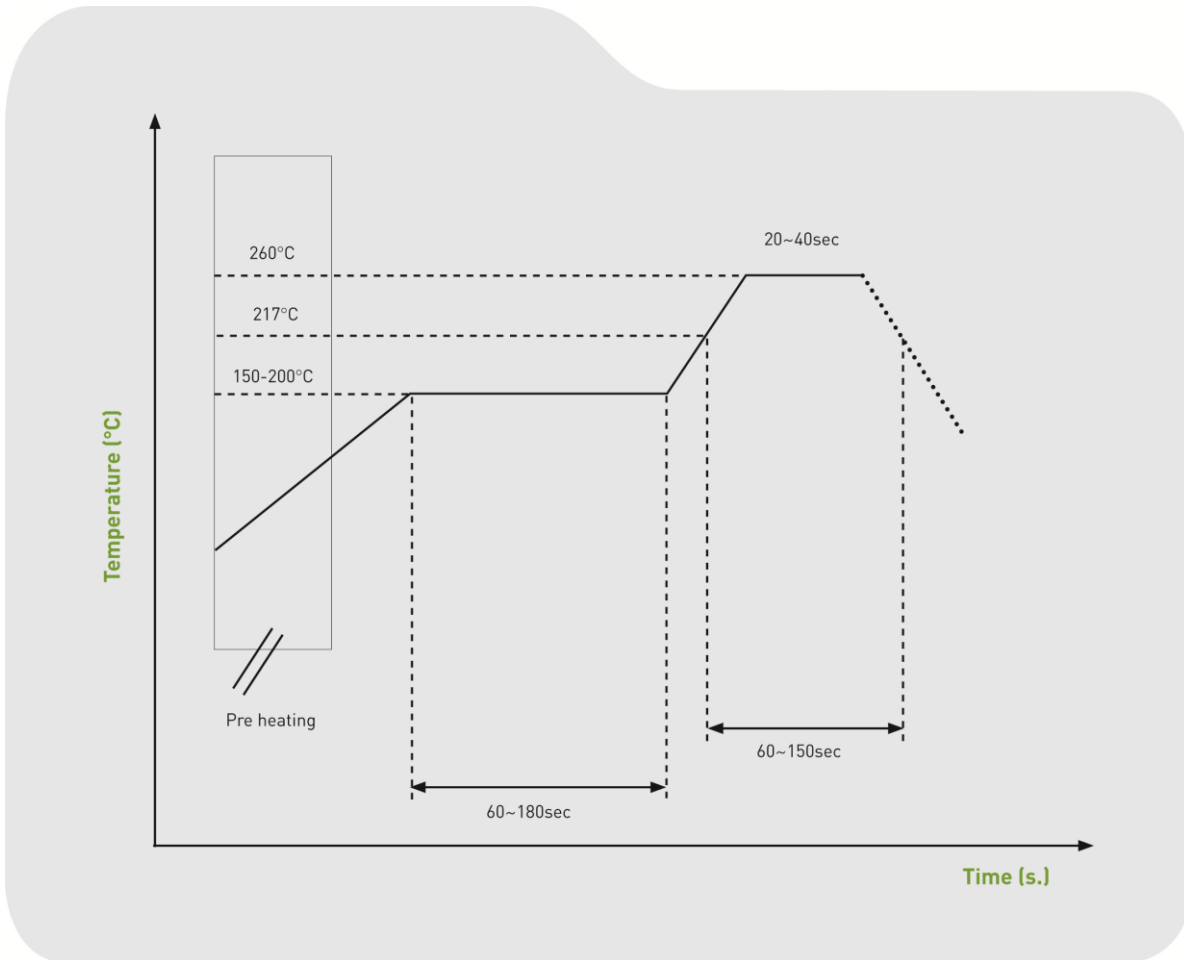

## 9. Packing

Quantity: 4000pcs/ Reel

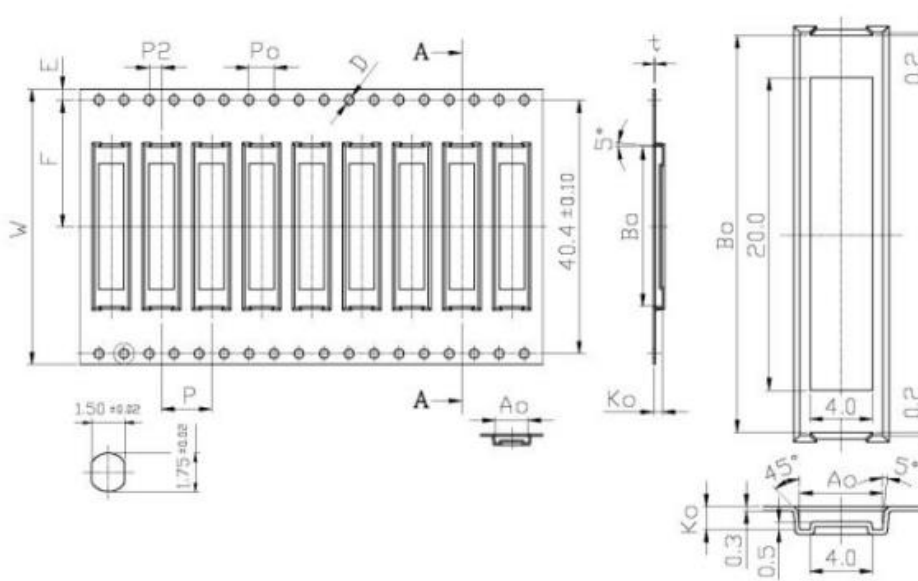

Tape

Dimensions (unit: mm)

Feature	Specification	Tolerance
W	44.00	±0.30
P	8.00	±0.10
E	1.75	±0.10
F	20.20	±0.10
P2	2.00	±0.10
D	1.50	+0.10 / -0.00
D1	2.00	±0.10
Po	4.00	±0.10
10Po	40.00	±0.20

Pocket Dimensions (unit: mm)

Feature	Specification	Tolerance
Ao	5.3	+0.10
Bo	25.45	-0.10
Ko	1.50	±0.05
t	0.30	±0.05

1. Cumulative tolerance of 10 pocket hole pitch: ±0.20mm
2. Carrier camber not to exceed 1mm in 250mm
3. Ao and Bo measured on a plane above the inside bottom of the pocket
4. Ko measured from a plane on the inside bottom of the pocket to the top surface of the carrier
5. All dimensions meet EIA-481-B requirements
6. Material – Clear non Anti-Static Polystyrene, Black Conductive Polystyrene



Компания «Life Electronics» занимается поставками электронных компонентов импортного и отечественного производства от производителей и со складов крупных дистрибьюторов Европы, Америки и Азии.

С конца 2013 года компания активно расширяет линейку поставок компонентов по направлению коаксиальный кабель, кварцевые генераторы и конденсаторы (керамические, пленочные, электролитические), за счёт заключения дистрибьюторских договоров

Мы предлагаем:

- Конкурентоспособные цены и скидки постоянным клиентам.
- Специальные условия для постоянных клиентов.
- Подбор аналогов.
- Поставку компонентов в любых объемах, удовлетворяющих вашим потребностям.
- Приемлемые сроки поставки, возможна ускоренная поставка.
- Доставку товара в любую точку России и стран СНГ.
- Комплексную поставку.
- Работу по проектам и поставку образцов.
- Формирование склада под заказчика.
- Сертификаты соответствия на поставляемую продукцию (по желанию клиента).
- Тестирование поставляемой продукции.
- Поставку компонентов, требующих военную и космическую приемку.
- Входной контроль качества.
- Наличие сертификата ISO.

В составе нашей компании организован Конструкторский отдел, призванный помогать разработчикам, и инженерам.

Конструкторский отдел помогает осуществить:

- Регистрацию проекта у производителя компонентов.
- Техническую поддержку проекта.
- Защиту от снятия компонента с производства.
- Оценку стоимости проекта по компонентам.
- Изготовление тестовой платы монтаж и пусконаладочные работы.



Тел: +7 (812) 336 43 04 (многоканальный)  
Email: [org@lifeelectronics.ru](mailto:org@lifeelectronics.ru)