

IEC Appliance Inlet C14 or C18 with Line Switch 2 pole and Fuseholder 1- or 2-pole



See below:
[Approvals and Compliances](#)

Description

- Panel mount :
 Screw-on version from front or rear side , Appliance Inlet , protection class I or II , Fuseholder for fuse-links 5 x 20 mm , Line Switch 2-pole
- Meets the requirements of IEC 60335-1 for appliances in unattended use. This includes the enhanced requirements of glow wire tests acc. to IEC 60695-2-11 or -12 &-13.
- Solder terminals or quick connect terminals

Characteristics

- Line switch non-illuminated or illuminated

References

Alternative: version with line filter [FKI](#); [FKID](#)

Weblinks

[pdf data sheet](#), [html datasheet](#), [General Product Information](#), [Distributor-Stock-Check](#), [Accessories](#), [Detailed request for product](#)

Technical Data

Ratings IEC	10A / 250VAC; 50Hz
Ratings UL/CSA	10A / 250VAC; 60Hz
Dielectric Strength	> 1.5kVAC between L-N > 3kVAC between L/N-PE (1 min/50Hz)
Allowable Operation Temperature	-25 °C to 70 °C
IP-Protection	from front side IP20 acc. to IEC 60529
Protection against electric shock	Suitable for appliances with protection class I or II acc. to IEC 61140
Terminal	Solder terminals or quick connect terminals
Material: Housing	PA6, black, UL 94V-0

appliance inlet/-outlet	C14 / C18 acc. to IEC 60320-1 UL 60320-1, CSA C22.2 no. 60320-1 (for cold conditions) pin-temperature 70 °C, 10A, Protection Class I or II
Fuseholder	1 or 2 pole, acc. to IEC 60127-6, for fuse-links 5 x 20mm
Power Acceptance @ Ta > 23°C	Admissible power acceptance at higher ambient temperature see derating curves
Line Switch	Rocker switch 2-pole, non-illuminated or illuminated black, acc. to Technical Details

Approvals and Compliances

Detailed information on product approvals, code requirements, usage instructions and detailed test conditions can be looked up in [Details about Approvals](#)

SCHURTER products are designed for use in industrial environments. They have approvals from independent testing bodies according to national and international standards. Products with specific characteristics and requirements such as required in the automotive sector according to IATF 16949, medical technology according to ISO 13485 or in the aerospace industry can be offered exclusively with customer-specific, individual agreements by SCHURTER.

Approvals





The approval mark is used by the testing authorities to certify compliance with the safety requirements placed on electronic products.

Approval Reference Type: 6765

Approval Logo	Certificates	Certification Body	Description
	SEMKO Approvals	SEMKO	Certificate Number: SE/09137-1A
	UL Approvals	UL	UL File Number: E93617



Product standards

Product standards that are referenced

Organization	Design	Standard	Description
	Designed according to	IEC 60320-1	Appliance couplers for household and similar general purposes
	Designed according to	IEC 60127-6	Miniature fuses. Part 6. Fuse-holders for miniature fuse-links
	Designed according to	UL 60320-1	Standard for Attachment Plugs and Receptacles
	Designed according to	CSA C22.2 no. 60320-1	General Use Receptacles, Attachment Plugs, and Similar Wiring Devices





Application standards

Application standards where the product can be used

Organization	Design	Standard	Description
	Designed for applications acc.	IEC/UL 60950	IEC 60950-1 includes the basic requirements for the safety of information technology equipment.
	Designed for applications acc.	IEC 60335-1	Safety of electrical appliances for household and similar purposes. Meets the requirements for appliances in unattended use. This includes the enhanced requirements of glow wire tests acc. to IEC 60695-2-11 or -12 & -13.

Compliances

The product complies with following Guide Lines

Identification	Details	Initiator	Description
	CE declaration of conformity	SCHURTER AG	The CE marking declares that the product complies with the applicable requirements laid down in the harmonisation of Community legislation on its affixing in accordance with EU Regulation 765/2008.
	RoHS	SCHURTER AG	Directive RoHS 2011/65/EU, Amendment (EU) 2015/863
	China RoHS	SCHURTER AG	The law SJ / T 11363-2006 (China RoHS) has been in force since 1 March 2007. It is similar to the EU directive RoHS.
	REACH	SCHURTER AG	On 1 June 2007, Regulation (EC) No 1907/2006 on the Registration, Evaluation, Authorization and Restriction of Chemicals 1 (abbreviated as "REACH") entered into force.
	White Paper Glow wire test	SCHURTER AG	Meets the requirements of IEC 60335-1 for appliances in unattended use. This includes the enhanced requirements of glow wire tests acc. to IEC 60695-2-11 or -12 & -13.

Dimensions [mm]

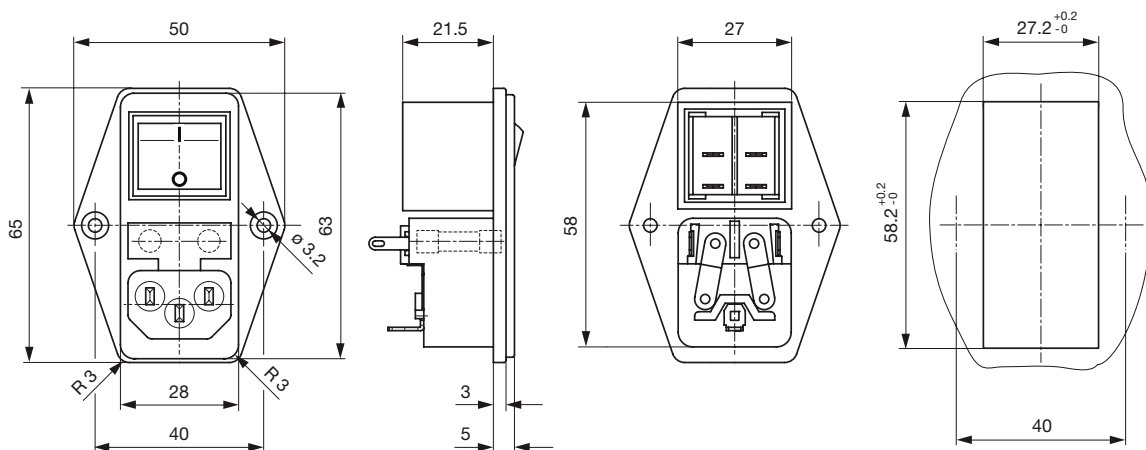

Length of the terminal please find at the order code configuration table

Derating Curves

1-pole

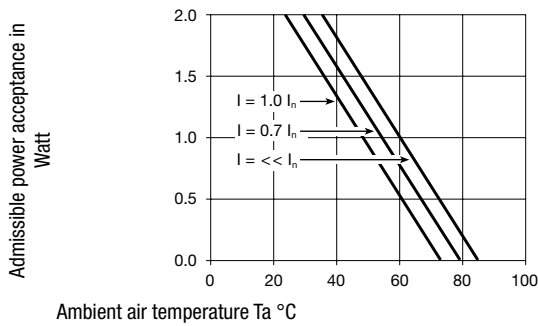

2-pole

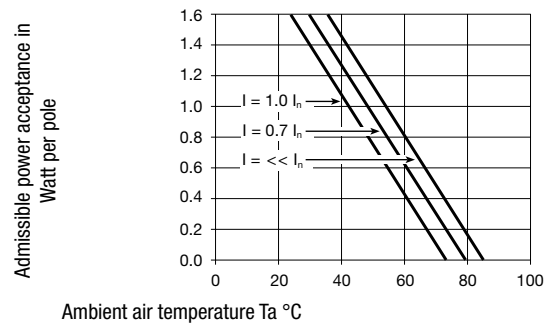

Config. Code

6765 - H - ABCN - D - EGOP

The characters are placeholders for the correspondingly keys of selections from the key tables.

6765 - H - ABCN - D - EGOP = Type

Type	Configuration key
protection class II	B
protection class I	X

6765 - H - A ABCN - D - EGOP = Terminals

Terminal L	Configuration key
connection to fuse holder	B

6765 - H - A B CN - D - EGOP = Terminals

Terminal N	Configuration key
short solder terminal (L = 4.8 mm)	2
long solder terminal (L = 8.5 mm)	3
Blade terminal (4.8 x 0.8 mm)	8
Blade terminal (6.3 x 0.8 mm)	9
connection to fuse holder	B

Symbols similar as in table A

6765 - H - AB C N - D - EGOP = Terminals

Terminal Ground	Configuration key
without terminal	0
short solder terminal (L = 4.8 mm)	2
long solder terminal (L = 8.5 mm)	3
Blade terminal (4.8 x 0.8 mm)	8
Blade terminal (6.3 x 0.8 mm)	9

Symbols similar as in table A

6765 - H - ABC N - D - EGOP = Terminal Fuseholder

Terminal Fuseholder	Configuration key
solder terminal	1

6765 - H - ABCN - D - EGOP = Color

Color	Configuration key
Black	A

6765 - H - ABCN - D - E GOP = Style

Style	Configuration key
flange with countersunk holes	1

6765 - H - ABCN - D - E G OP = Dimension S

Dimension "S"	Configuration key
00	

The dimension "S" is displayed in (1/10 mm). This information is also valid for the order code

6765 - H - ABCN - D - EG OP = Features

Features	Configuration key
dead cover	1
holder for 1 or 2 fuses (text legible, when inlet on top)	4
holder for 1 or 2 fuses (text legible, when inlet on bottom)	5

6765 - H - ABCN - D - EGO P = Switches

Switches	Configuration key
not used	0
dead cover	1
bipolar switch, 4,8mm blade terminal, black rocker	4
bipolar switch, solder terminals, black rocker	5
bipolar switch, 4,8mm blade terminal, rocker red illuminated	6
bipolar switch, solder terminal, rocker red illuminated	7
bipolar switch, 4,8mm blade terminals, rocker green illuminated	8
bipolar switch, solder terminals, rocker green illuminated	9

All Variants

Type	Terminal L	Terminal N	Terminal Ground	Features	Switches	Config. Code	V-Lock	Order Number
protection class I	connection to fuse holder	connection to fuse holder	short solder terminal (L = 4.8 mm)	holder for 1 or 2 fuses (text legible, when inlet on top)	not used	6765-X-BB21-A-10040		4304.6078
protection class I	connection to fuse holder	connection to fuse holder	short solder terminal (L = 4.8 mm)	holder for 1 or 2 fuses (text legible, when inlet on top)	bipolar switch, 4,8mm blade terminal, black rocker	6765-X-BB21-A-10044		4304.6079
protection class I	connection to fuse holder	connection to fuse holder	short solder terminal (L = 4.8 mm)	holder for 1 or 2 fuses (text legible, when inlet on top)	bipolar switch, solder terminals, black rocker	6765-X-BB21-A-10045		4304.6080
protection class I	connection to fuse holder	connection to fuse holder	short solder terminal (L = 4.8 mm)	holder for 1 or 2 fuses (text legible, when inlet on bottom)	bipolar switch, 4,8mm blade terminal, black rocker	6765-X-BB21-A-10054		4304.6081
protection class I	connection to fuse holder	connection to fuse holder	short solder terminal (L = 4.8 mm)	holder for 1 or 2 fuses (text legible, when inlet on bottom)	bipolar switch, solder terminals, black rocker	6765-X-BB21-A-10055		4304.6082
protection class I	connection to fuse holder	connection to fuse holder	Blade terminal (4.8 x 0.8 mm)	holder for 1 or 2 fuses (text legible, when inlet on top)	not used	6765-X-BB81-A-10040		4304.6085
protection class I	connection to fuse holder	connection to fuse holder	Blade terminal (4.8 x 0.8 mm)	holder for 1 or 2 fuses (text legible, when inlet on top)	bipolar switch, 4,8mm blade terminal, black rocker	6765-X-BB81-A-10044		4304.6087
protection class I	connection to fuse holder	connection to fuse holder	Blade terminal (4.8 x 0.8 mm)	holder for 1 or 2 fuses (text legible, when inlet on top)	bipolar switch, 4,8mm blade terminal, rocker red illuminated	6765-X-BB81-A-10046		4304.6088
protection class I	connection to fuse holder	connection to fuse holder	Blade terminal (4.8 x 0.8 mm)	holder for 1 or 2 fuses (text legible, when inlet on top)	bipolar switch, 4,8mm blade terminals, rocker green illuminated	6765-X-BB81-A-10048		4304.6089
protection class I	connection to fuse holder	connection to fuse holder	Blade terminal (4.8 x 0.8 mm)	holder for 1 or 2 fuses (text legible, when inlet on bottom)	bipolar switch, 4,8mm blade terminal, black rocker	6765-X-BB81-A-10054		4304.6090
protection class I	connection to fuse holder	connection to fuse holder	Blade terminal (4.8 x 0.8 mm)	holder for 1 or 2 fuses (text legible, when inlet on bottom)	bipolar switch, 4,8mm blade terminals, rocker green illuminated	6765-X-BB81-A-10058		4304.6091
protection class I	connection to fuse holder	connection to fuse holder	Blade terminal (6.3 x 0.8 mm)	holder for 1 or 2 fuses (text legible, when inlet on top)	bipolar switch, 4,8mm blade terminal, black rocker	6765-X-BB91-A-10044		4304.6092
protection class I	connection to fuse holder	connection to fuse holder	Blade terminal (6.3 x 0.8 mm)	holder for 1 or 2 fuses (text legible, when inlet on top)	bipolar switch, solder terminals, black rocker	6765-X-BB91-A-10045		4304.6093
protection class I	connection to fuse holder	connection to fuse holder	Blade terminal (6.3 x 0.8 mm)	holder for 1 or 2 fuses (text legible, when inlet on top)	bipolar switch, 4,8mm blade terminal, rocker red illuminated	6765-X-BB91-A-10046		4304.6094
protection class I	connection to fuse holder	connection to fuse holder	Blade terminal (6.3 x 0.8 mm)	holder for 1 or 2 fuses (text legible, when inlet on bottom)	bipolar switch, 4,8mm blade terminal, black rocker	6765-X-BB91-A-10054		4304.6095
protection class I	connection to fuse holder	connection to fuse holder	without terminal	holder for 1 or 2 fuses (text legible, when inlet on top)	not used	6765-X-BB01-A-10040		4304.6122
protection class I	connection to fuse holder	connection to fuse holder	Blade terminal (6.3 x 0.8 mm)	holder for 1 or 2 fuses (text legible, when inlet on top)	bipolar switch, 4,8mm blade terminals, rocker green illuminated	6765-X-BB91-A-10048		4304.6153
protection class I	connection to fuse holder	connection to fuse holder	short solder terminal (L = 4.8 mm)	holder for 1 or 2 fuses (text legible, when inlet on bottom)	not used	6765-X-BB21-A-10050		4304.6203
protection class I	connection to fuse holder	connection to fuse holder	short solder terminal (L = 4.8 mm)	holder for 1 or 2 fuses (text legible, when inlet on top)	bipolar switch, 4,8mm blade terminals, rocker green illuminated	6765-X-BB21-A-10048		4304.6215

The listed variants should be available from stock Other versions on request www.schurter.com/contact

Most Popular.

Availability for all products can be searched real-time: <https://www.schurter.com/en/Stock-Check/Stock-Check-SCHURTER>

Packaging unit 50 Pcs

Accessories

Description



Wire Harness
 Wire harness for SCHURTER products

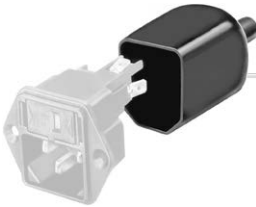

Assorted Covers
 Rear Cover

Mating Outlets/Connectors

Category / Description

Connector Overview complete



4022 Mounting: Power Supply Cord, 3 x 1.5 mm ² , Screw clamps, Connector: IEC C13	4022
4782 Mounting: Power Cord, 3 x 1 mm ² / 3 x 18 AWG, Cable, Connector: IEC C13	4782
4012 Mounting: Power Supply Cord, 3 x 1 mm ² , Screw clamps, Connector: IEC C13	4012
4785 Mounting: Power Cord, 3 x 1 mm ² / 3 x 18 AWG, Cable, Connector: IEC C13	4785
4300-06 Mounting: Power Cord, 3 x 1 mm ² / 3 x 18 AWG, Cable, Connector: IEC C13	4300-06
Connector further types to 6765	...

Interconnection Cord Overview complete



Cord Sets 10 A, Interconnection, 2.0 m, IEC H05VV-F3G1.0, black	6007.0204
Cord Sets 10 A, Interconnection, 1.0 m, Connector IEC C13, H05VV-F3G1.0, black	6007.0212
Cord Sets 10 A, Interconnection, 2.0 m, Connector IEC C13, H05VV-F3G1.0, black	6007.0214
Interconnection Cord further types to 6765	...

Power Supply Cord Overview complete



Cord Sets 10 A, Europlug, 2.5 m, Connector IEC C13, H05VV-F3G1.0, black	6004.0215
Cord Sets 10 A, Europlug, 2.5 m, Connector IEC C13, H05VV-F3G1.0, black	6003.0215
Cord Sets 10 A, uninsulated wires, 2.0 m, Connector IEC C13, H05VV-F3G1.0, black	6000.0224
Cord Sets 10 A, uninsulated wires, 2.0 m, Connector IEC C13, H05VV-F3G1.0, black	6000.0214
Cord Sets 10 A, United Kingdom, 2.5 m, Connector IEC C13, H05VV-F3G1.0, black	6044.0215
Power Supply Cord further types to 6765	...

Power Supply or Interconnection Cord Overview complete



Cord Sets 10 A, United Kingdom, 2.0 m, Connector IEC H05VV-F3G1.0, black	6044.0204
Power Supply or Interconnection Cord further types to 6765	...

Mating Outlets/Connectors shuttered



[Power Cord Overview complete](#)

VAC17KS, V-Lock cord retaining, diverse m, Connector IEC C17, diverse, black / grey / white

VAC17KS

[Power Cord further types to 6765](#)

Компания «Life Electronics» занимается поставками электронных компонентов импортного и отечественного производства от производителей и со складов крупных дистрибьюторов Европы, Америки и Азии.

С конца 2013 года компания активно расширяет линейку поставок компонентов по направлению коаксиальный кабель, кварцевые генераторы и конденсаторы (керамические, пленочные, электролитические), за счёт заключения дистрибьюторских договоров

Мы предлагаем:

- Конкуренспособные цены и скидки постоянным клиентам.
- Специальные условия для постоянных клиентов.
- Подбор аналогов.
- Поставку компонентов в любых объемах, удовлетворяющих вашим потребностям.
- Приемлемые сроки поставки, возможна ускоренная поставка.
- Доставку товара в любую точку России и стран СНГ.
- Комплексную поставку.
- Работу по проектам и поставку образцов.
- Формирование склада под заказчика.
- Сертификаты соответствия на поставляемую продукцию (по желанию клиента).
- Тестирование поставляемой продукции.
- Поставку компонентов, требующих военную и космическую приемку.
- Входной контроль качества.
- Наличие сертификата ISO.

В составе нашей компании организован Конструкторский отдел, призванный помогать разработчикам, и инженерам.

Конструкторский отдел помогает осуществить:

- Регистрацию проекта у производителя компонентов.
- Техническую поддержку проекта.
- Защиту от снятия компонента с производства.
- Оценку стоимости проекта по компонентам.
- Изготовление тестовой платы монтаж и пусконаладочные работы.



Тел: +7 (812) 336 43 04 (многоканальный)
Email: org@lifeelectronics.ru