

# Two-Piece 4.0mm Pitch Battery

9155-400

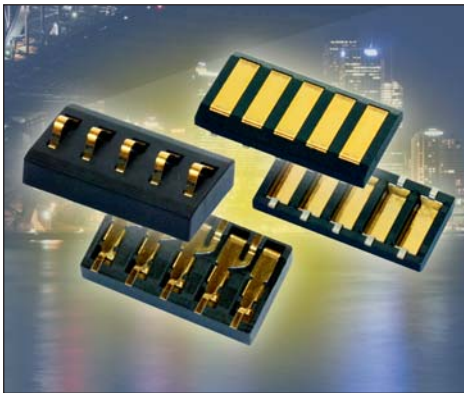

This unique battery or removable module style connector is different from most others in that it allows for the pluggable device to be swiped or connected from either direction. The spring contact offers enhanced contact deflection range over existing connectors in the market with a full 1.4mm of travel after contact engagement. This contact design allows the connector to absorb more of the plastic or housing tolerances making it more functional and reliable in real life applications.

The fixed pad connector is unique in the industry as it replaces the plating of gold directly onto PCB pads. The main benefit of using this connector is to elevate the pad surface well above the PCB so that the gold contacts are close to flush with the outside packaging. This minimizes the distance that a spring contact would need to absorb in the mating tolerance band. Also unique to this connector is the angled contact lead-in on both sides which facilitates smooth engagement of the spring contact from either direction.

## APPLICATIONS

- Portable electronics requiring a removable battery
- Interface for removable/pluggable modules or cartridges
- Docking cradle for charging and data transfer

## FEATURES AND BENEFITS

- Proven contact reliability in harsh industrial or medical applications
- Increased contact deflection range above existing connectors on the market
- Gold plated Beryllium contact spring contact assures maximum contact reliability and functionality up to 5000 cycles
- Beveled lead in on pad connector facilitates smooth module engagement from either direction

## ELECTRICAL

- Current Rating: 5A/contact
- Voltage Rating: 125 VAC

## ENVIRONMENTAL

- Operating Temperature: -40°C to +125°C

## MECHANICAL

- Contact Material: Spring contact is Be Cu, Fixed contact is Phosphor Bronze
- Contact Plating: Gold over nickel mating area, pure Tin SMT tails
- Durability 5000 Cycles

## HOW TO ORDER

<b>00</b>	<b>9155</b>	<b>005</b>
Prefix	Series	Number of Ways
		002 = 2
		003 = 3
		004 = 4
		005 = 5
		006 = 6

**40X**

### Standard Battery Connector

Code	Description	Reel Qty.
401	Battery Connector - Sprung Half	550
402	Battery Connector - Fixed Half	1100

**00X**

### Plating Option

- 6 = 0.4µm Selective Gold, Pure Tin Tail
- 8 = 0.8µm Selective Gold, Pure Tin Tail



# Two-Piece 4.0mm Pitch Battery

9155-400

## 2 WAY BATTERY CONNECTOR – SPRUNG HALF



**DETAIL A**



**SECTION ON Z-Z**



**NOTES:**

1. GENERAL TOLERANCE  $\pm 0.20$  UNLESS OTHERWISE STATED.
2. FOR FURTHER DETAILS REFER TO AVX SPECIFICATION 201-01-207.
3. ADDITIONAL INFORMATION AND BASIC MATING DETAILS REFER TO PAGES 12-14.
4. PACKING DETAILS ON PAGE 15.
5. CONNECTOR OUTLINE.
6. RECOMMENDED PLATING ON MATING PADS. GOLD OVER NICKEL.
7. FOR OTHER TAN VERTICAL MATING WE RECOMMEND MATING WITH THE FIXED CONNECTOR, REFER TO PAGE 13.

# Two-Piece 4.0mm Pitch Battery

9155-400

## 3 WAY BATTERY CONNECTOR – SPRUNG HALF



**DETAIL A**

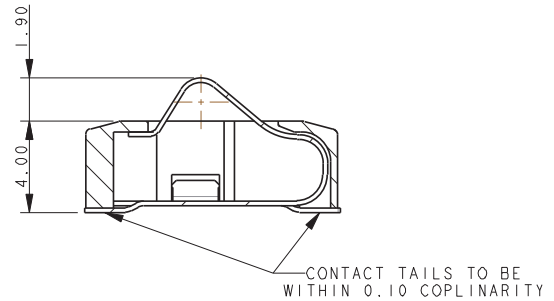
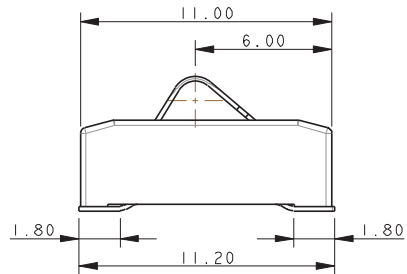
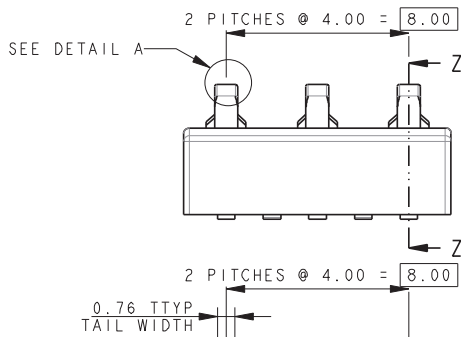

**SECTION ON Z-Z**

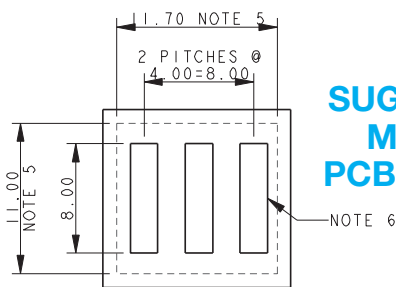

**SUGGESTED MATING PCB LAYOUT**

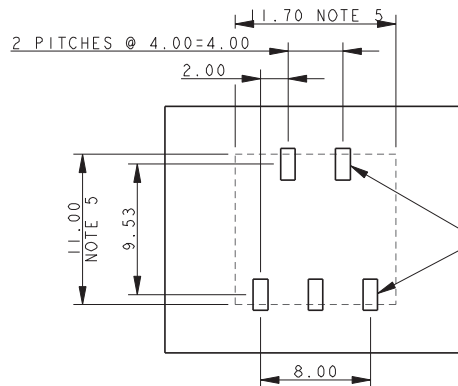

**SUGGESTED SMT PCB LAYOUT**

**NOTES:**

1. GENERAL TOLERANCE  $\pm 0.20$  UNLESS OTHERWISE STATED.
2. FOR FURTHER DETAILS REFER TO AVX SPECIFICATION 201-01-207.
3. ADDITIONAL INFORMATION AND BASIC MATING DETAILS REFER TO PAGES 12-14.
4. PACKING DETAILS ON PAGE 15.
5. CONNECTOR OUTLINE.
6. RECOMMENDED PLATING ON MATING PADS. GOLD OVER NICKEL.
7. FOR OTHER TAN VERTICAL MATING WE RECOMMEND MATING WITH THE FIXED CONNECTOR, REFER TO PAGE 13.

# Two-Piece 4.0mm Pitch Battery

9155-400

## 4 WAY BATTERY CONNECTOR – SPRUNG HALF



**DETAIL A**



**SECTION ON Z-Z**



**NOTES:**

1. GENERAL TOLERANCE  $\pm 0.20$  UNLESS OTHERWISE STATED.
2. FOR FURTHER DETAILS REFER TO AVX SPECIFICATION 201-01-207.
3. ADDITIONAL INFORMATION AND BASIC MATING DETAILS REFER TO PAGES 12-14.
4. PACKING DETAILS ON PAGE 15.
5. CONNECTOR OUTLINE.
6. RECOMMENDED PLATING ON MATING PADS. GOLD OVER NICKEL.
7. FOR OTHER TAN VERTICAL MATING WE RECOMMEND MATING WITH THE FIXED CONNECTOR, REFER TO PAGE 13.

# Two-Piece 4.0mm Pitch Battery

9155-400

## 5 WAY BATTERY CONNECTOR – SPRUNG HALF

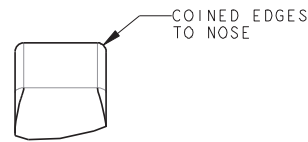

**DETAIL A**

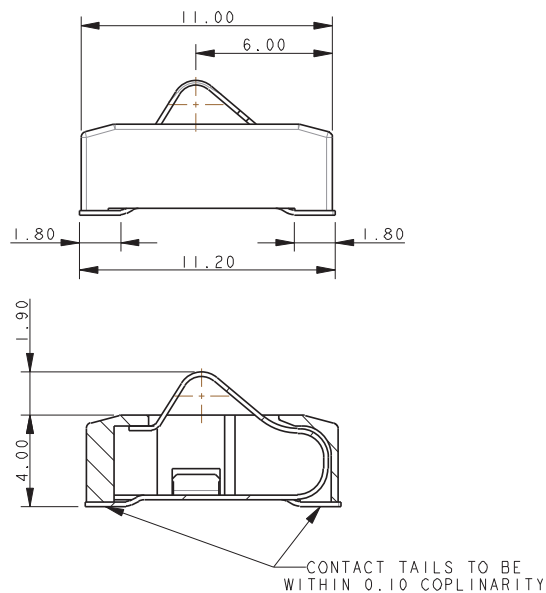

**SECTION ON Z-Z**

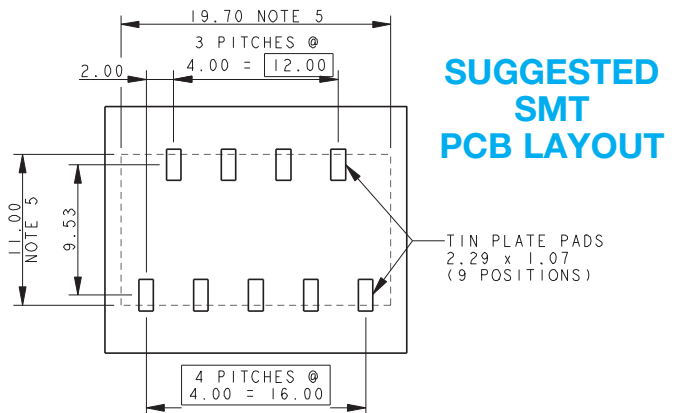
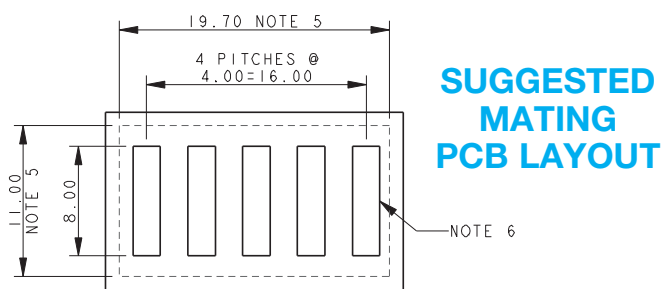

**NOTES:**

1. GENERAL TOLERANCE  $\pm 0.20$  UNLESS OTHERWISE STATED.
2. FOR FURTHER DETAILS REFER TO AVX SPECIFICATION 201-01-207.
3. ADDITIONAL INFORMATION AND BASIC MATING DETAILS REFER TO PAGES 12-14.
4. PACKING DETAILS ON PAGE 15.
5. CONNECTOR OUTLINE.
6. RECOMMENDED PLATING ON MATING PADS. GOLD OVER NICKEL.
7. FOR OTHER TAN VERTICAL MATING WE RECOMMEND MATING WITH THE FIXED CONNECTOR, REFER TO PAGE 13.

# Two-Piece 4.0mm Pitch Battery

9155-400

## 6 WAY BATTERY CONNECTOR – SPRUNG HALF

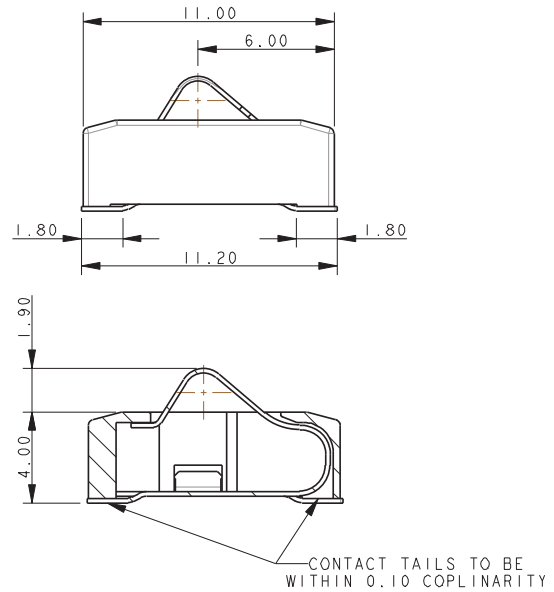

### SECTION ON Z-Z

### SUGGESTED SMT PCB LAYOUT

### SUGGESTED MATING PCB LAYOUT

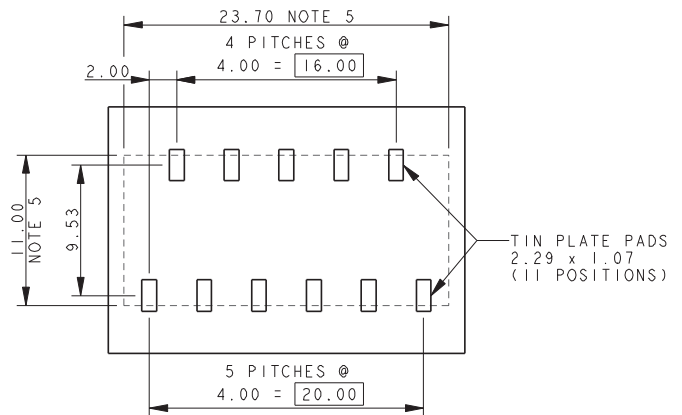
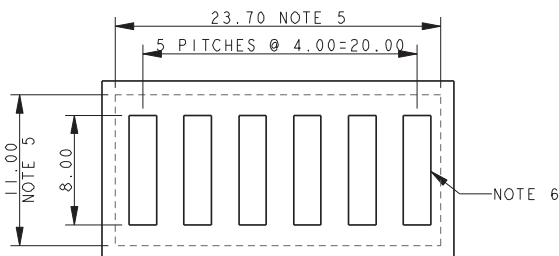

**NOTES:**

1. GENERAL TOLERANCE  $\pm 0.20$  UNLESS OTHERWISE STATED.
2. FOR FURTHER DETAILS REFER TO AVX SPECIFICATION 201-01-207.
3. ADDITIONAL INFORMATION AND BASIC MATING DETAILS REFER TO PAGES 12-14.
4. PACKING DETAILS ON PAGE 15.
5. CONNECTOR OUTLINE.
6. RECOMMENDED PLATING ON MATING PADS. GOLD OVER NICKEL.
7. FOR OTHER TAN VERTICAL MATING WE RECOMMEND MATING WITH THE FIXED CONNECTOR, REFER TO PAGE 13.

# Two-Piece 4.0mm Pitch Battery

9155-400

## 2 WAY BATTERY CONNECTOR – FIXED HALF OPTIONAL



NOTES:

1. GENERAL TOLERANCE  $\pm 0.20$  UNLESS OTHERWISE STATED.
2. FOR FURTHER DETAILS REFER TO AVX SPECIFICATION 201-01-207.
3. ADDITIONAL INFORMATION AND BASIC MATING DETAILS REFER TO PAGES 12-13.
4. PACKING DETAILS ON PAGE 15.
5. CONNECTOR OUTLINE.

# Two-Piece 4.0mm Pitch Battery

9155-400

## 3 WAY BATTERY CONNECTOR – FIXED HALF OPTIONAL



NOTES:

1. GENERAL TOLERANCE  $\pm 0.20$  UNLESS OTHERWISE STATED.
2. FOR FURTHER DETAILS REFER TO AVX SPECIFICATION 201-01-207.
3. ADDITIONAL INFORMATION AND BASIC MATING DETAILS REFER TO PAGES 12-13.
4. PACKING DETAILS ON PAGE 15.
5. CONNECTOR OUTLINE.



# Two-Piece 4.0mm Pitch Battery

9155-400

## 4 WAY BATTERY CONNECTOR – FIXED HALF OPTIONAL

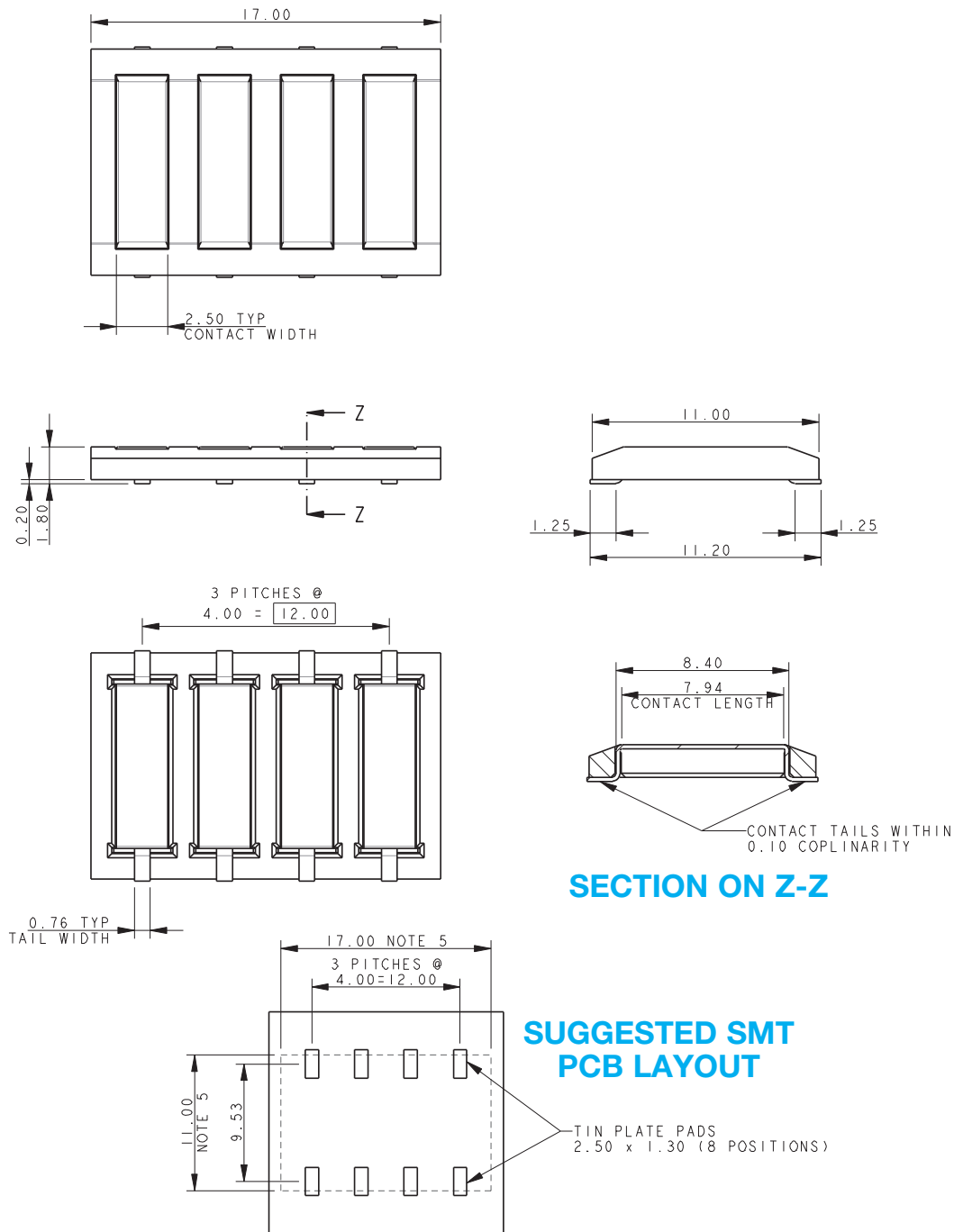

**NOTES:**

1. GENERAL TOLERANCE  $\pm 0.20$  UNLESS OTHERWISE STATED.
2. FOR FURTHER DETAILS REFER TO AVX SPECIFICATION 201-01-207.
3. ADDITIONAL INFORMATION AND BASIC MATING DETAILS REFER TO PAGES 12-13.
4. PACKING DETAILS ON PAGE 15.
5. CONNECTOR OUTLINE.

# Two-Piece 4.0mm Pitch Battery

9155-400

## 5 WAY BATTERY CONNECTOR – FIXED HALF OPTIONAL



# Two-Piece 4.0mm Pitch Battery

9155-400

## 6 WAY BATTERY CONNECTOR – FIXED HALF OPTIONAL

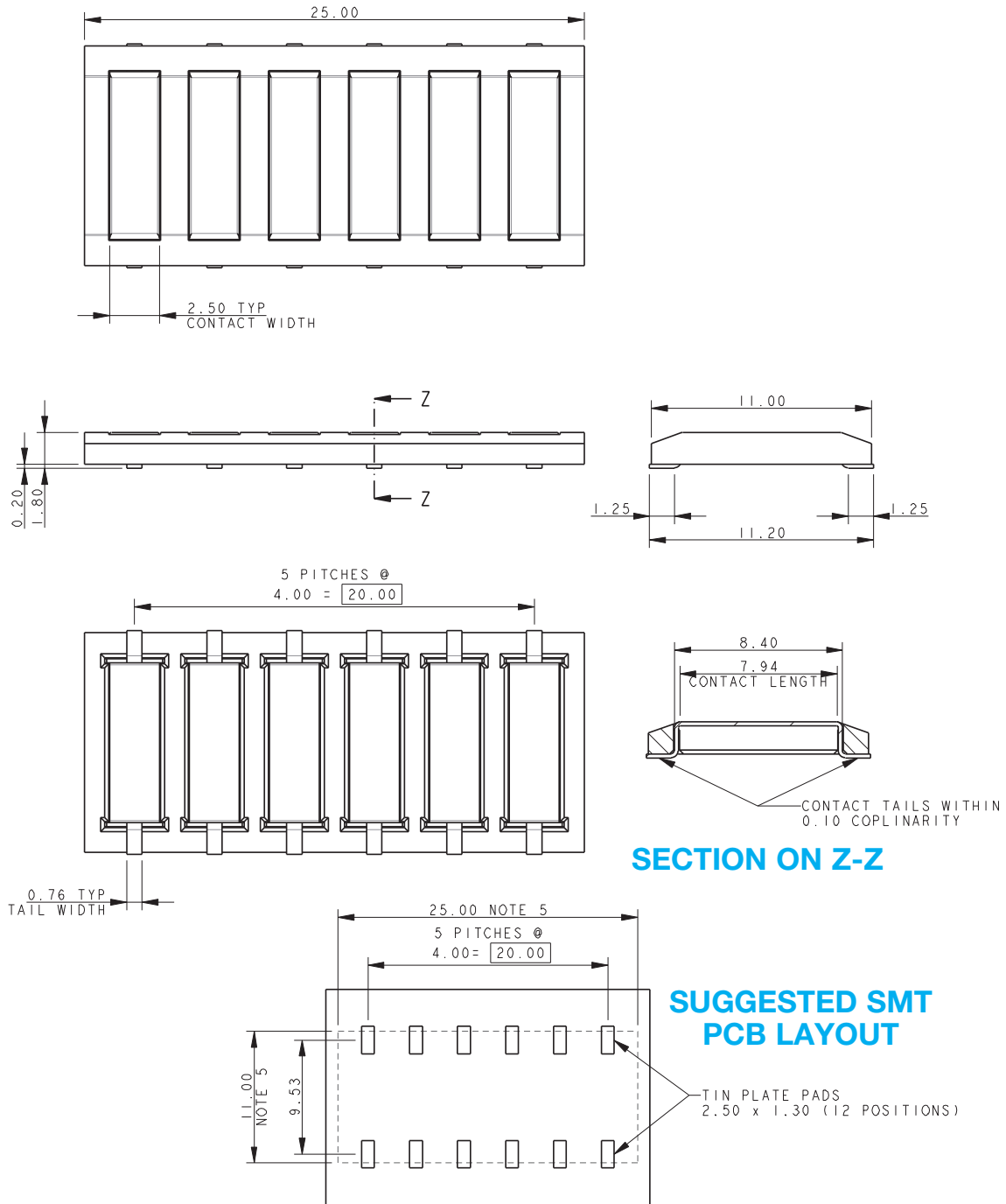

**NOTES:**

1. GENERAL TOLERANCE  $\pm 0.20$  UNLESS OTHERWISE STATED.
2. FOR FURTHER DETAILS REFER TO AVX SPECIFICATION 201-01-207.
3. ADDITIONAL INFORMATION AND BASIC MATING DETAILS REFER TO PAGES 12-13.
4. PACKING DETAILS ON PAGE 15.
5. CONNECTOR OUTLINE.

# Two-Piece 4.0mm Pitch Battery

9155-400

## BATTERY CONNECTOR - MATING DETAILS SPRUNG HALF MATED WITH FIXED HALF



CONNECTOR ASSEMBLY  
MAXIMUM GAP

PROJECTED CONTACT FORCE 0.67N

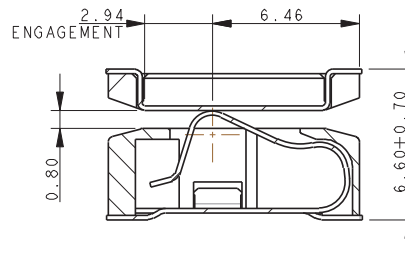

CONNECTOR ASSEMBLY  
NOMINAL GAP

PROJECTED CONTACT FORCE 1.23N



CONNECTOR ASSEMBLY  
MINIMUM GAP

PROJECTED CONTACT FORCE 1.70N

NOTES:

1. GENERAL TOLERANCE  $\pm 0.20$  UNLESS OTHERWISE STATED.
2. INSULATION MATERIAL: LCP, GLASS FILLED, UL94 V-0, COLOR BLACK.
3. CONTACT MATERIAL SPRUNG HALF: BERYLLIUM COPPER.
4. CONTACT MATERIAL FIXED HALF: PHOSPHOR BRONZE.
5. CONTACT PLATING: GOLD OVER NICKEL, PURE TIN TAILS.
6. DURABILITY 5000 OPERATIONS.
7. CURRENT RATING 5A.
8. CONTACT RESISTANCE 25m $\Omega$  MAX.

## BATTERY CONNECTOR - MATING DETAILS DIRECTION OF MATING



VERTICAL MATING



HORIZONTAL MATING - FROM EITHER END

## BATTERY CONNECTOR - MATING DETAILS SPRUNG HALF MATED WITH PCB

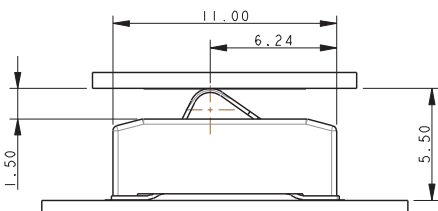

CONNECTOR ASSEMBLY  
MAXIMUM GAP

PROJECTED CONTACT FORCE 0.67N

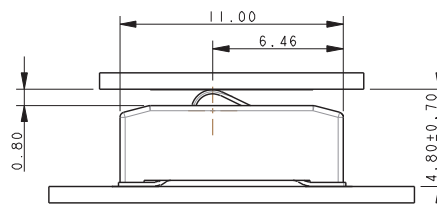

CONNECTOR ASSEMBLY  
NOMINAL GAP

PROJECTED CONTACT FORCE 1.23N

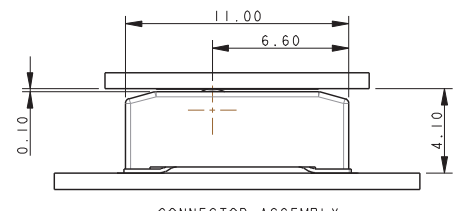

CONNECTOR ASSEMBLY  
MINIMUM GAP

PROJECTED CONTACT FORCE 1.70N

NOTES:

1. GENERAL TOLERANCE  $\pm 0.20$  UNLESS OTHERWISE STATED.
2. SPRUNG HALF MATED WITH GOLD PLATED PAD ON PCB
3. VERTICAL MATING ONLY.

# Two-Piece 4.0mm Pitch Battery

9155-400

## BI-DIRECTIONAL BATTERY CONNECTOR - PACKING DETAILS

### PACKING DETAILS SPRUNG CONNECTOR

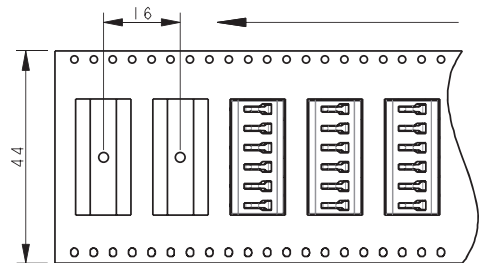
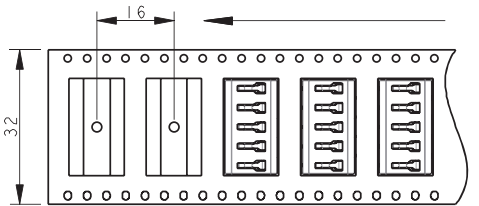
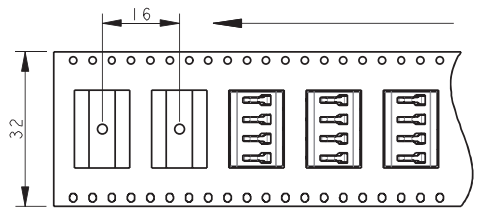
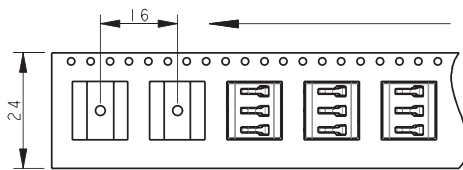
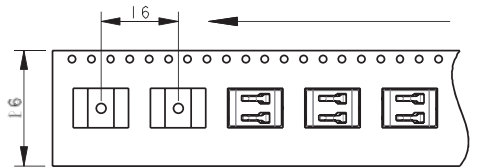

REEL QTY	550
LEADER	500mm
TRAILER	500mm

### PACKING DETAILS FIXED CONNECTOR

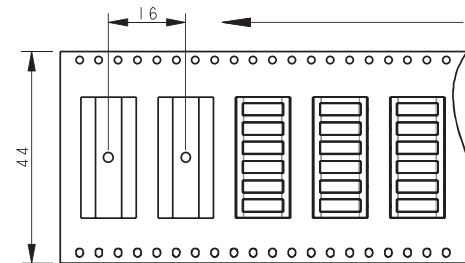
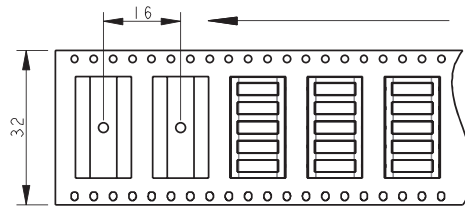
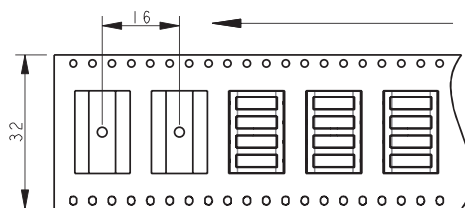
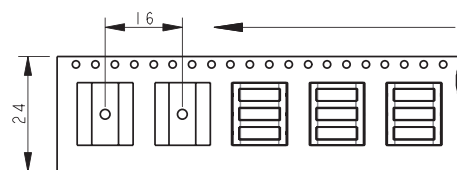
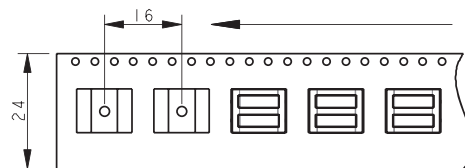

REEL QTY	1100
LEADER	500mm
TRAILER	500mm

UNREELED  
DIRECTION



330mm DIAMETER REEL

Компания «Life Electronics» занимается поставками электронных компонентов импортного и отечественного производства от производителей и со складов крупных дистрибьюторов Европы, Америки и Азии.

С конца 2013 года компания активно расширяет линейку поставок компонентов по направлению коаксиальный кабель, кварцевые генераторы и конденсаторы (керамические, пленочные, электролитические), за счёт заключения дистрибьюторских договоров

Мы предлагаем:

- Конкурентоспособные цены и скидки постоянным клиентам.
- Специальные условия для постоянных клиентов.
- Подбор аналогов.
- Поставку компонентов в любых объемах, удовлетворяющих вашим потребностям.
- Приемлемые сроки поставки, возможна ускоренная поставка.
- Доставку товара в любую точку России и стран СНГ.
- Комплексную поставку.
- Работу по проектам и поставку образцов.
- Формирование склада под заказчика.
- Сертификаты соответствия на поставляемую продукцию (по желанию клиента).
- Тестирование поставляемой продукции.
- Поставку компонентов, требующих военную и космическую приемку.
- Входной контроль качества.
- Наличие сертификата ISO.

В составе нашей компании организован Конструкторский отдел, призванный помогать разработчикам, и инженерам.

Конструкторский отдел помогает осуществить:

- Регистрацию проекта у производителя компонентов.
- Техническую поддержку проекта.
- Защиту от снятия компонента с производства.
- Оценку стоимости проекта по компонентам.
- Изготовление тестовой платы монтаж и пусконаладочные работы.



Тел: +7 (812) 336 43 04 (многоканальный)  
Email: [org@lifeelectronics.ru](mailto:org@lifeelectronics.ru)