

Important notice

Dear Customer,

On 7 February 2017 the former NXP Standard Product business became a new company with the tradename **Nexperia**. Nexperia is an industry leading supplier of Discrete, Logic and PowerMOS semiconductors with its focus on the automotive, industrial, computing, consumer and wearable application markets

In data sheets and application notes which still contain NXP or Philips Semiconductors references, use the references to Nexperia, as shown below.

Instead of <http://www.nxp.com>, <http://www.philips.com/> or <http://www.semiconductors.philips.com/>, use <http://www.nexperia.com>

Instead of sales.addresses@www.nxp.com or sales.addresses@www.semiconductors.philips.com, use salesaddresses@nexperia.com (email)

Replace the copyright notice at the bottom of each page or elsewhere in the document, depending on the version, as shown below:

- © NXP N.V. (year). All rights reserved or © Koninklijke Philips Electronics N.V. (year). All rights reserved

Should be replaced with:

- © **Nexperia B.V. (year). All rights reserved.**

If you have any questions related to the data sheet, please contact our nearest sales office via e-mail or telephone (details via salesaddresses@nexperia.com). Thank you for your cooperation and understanding,

Kind regards,

Team Nexperia

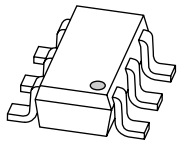

PBSS5420D

20 V, 4 A PNP low V_{CEsat} (BISS) transistor

Rev. 02 — 29 September 2008

Product data sheet

1. Product profile

1.1 General description

PNP low V_{CEsat} Breakthrough in Small Signal (BISS) transistor in a small SOT457 (SC-74) Surface-Mounted Device (SMD) plastic package.

NPN complement: PBSS4420D.

1.2 Features

- Very low collector-emitter saturation resistance
- Ultra low collector-emitter saturation voltage
- 4 A continuous collector current
- Up to 15 A peak current
- High efficiency leading to less heat generation

1.3 Applications

- Power management functions
- Charging circuits
- DC-to-DC conversion
- MOSFET gate driving
- Power switches (e.g. motors, fans)
- Thin Film Transistor (TFT) backlight inverter

1.4 Quick reference data

Table 1. Quick reference data

Symbol	Parameter	Conditions	Min	Typ	Max	Unit
V_{CEO}	collector-emitter voltage	open base	-	-	-20	V
I_C	collector current		[1]	-	-4	A
I_{CM}	peak collector current	single pulse; $t_p \leq 1$ ms	-	-	-15	A
R_{CEsat}	collector-emitter saturation resistance	$I_C = -4$ A; $I_B = -400$ mA	[2]	50	70	m Ω

[1] Device mounted on a ceramic Printed-Circuit Board (PCB), Al_2O_3 , standard footprint.

[2] Pulse test: $t_p \leq 300$ μ s; $\delta \leq 0.02$.

2. Pinning information

Table 2. Pinning

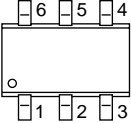
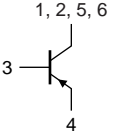
Pin	Description	Simplified outline	Graphic symbol
1	collector		
2	collector		
3	base		
4	emitter		
5	collector		
6	collector		

3. Ordering information

Table 3. Ordering information

Type number	Package		
	Name	Description	Version
PBSS5420D	SC-74	plastic surface-mounted package (TSOP6); 6 leads	SOT457

4. Marking

Table 4. Marking codes

Type number	Marking code
PBSS5420D	D5

5. Limiting values

Table 5. Limiting values

In accordance with the Absolute Maximum Rating System (IEC 60134).

Symbol	Parameter	Conditions	Min	Max	Unit
V_{CBO}	collector-base voltage	open emitter	-	-20	V
V_{CEO}	collector-emitter voltage	open base	-	-20	V
V_{EBO}	emitter-base voltage	open collector	-	-5	V
I_C	collector current		[1] -	-4	A
I_{CM}	peak collector current	single pulse; $t_p \leq 1$ ms	-	-15	A
I_B	base current		-	-0.8	A
I_{BM}	peak base current	single pulse; $t_p \leq 1$ ms	-	-2	A
P_{tot}	total power dissipation	$T_{amb} \leq 25$ °C	[2] -	360	mW
			[3] -	600	mW
			[4] -	750	mW
			[1] -	1.1	W
			[2][5] -	2.5	W

Table 5. Limiting values ...continued
In accordance with the Absolute Maximum Rating System (IEC 60134).

Symbol	Parameter	Conditions	Min	Max	Unit
T_j	junction temperature		-	150	°C
T_{amb}	ambient temperature		-65	+150	°C
T_{stg}	storage temperature		-65	+150	°C

- [1] Device mounted on a ceramic PCB, Al_2O_3 , standard footprint.
- [2] Device mounted on an FR4 PCB, single-sided copper, tin-plated and standard footprint.
- [3] Device mounted on an FR4 PCB, single-sided copper, tin-plated, mounting pad for collector 1 cm².
- [4] Device mounted on an FR4 PCB, single-sided copper, tin-plated, mounting pad for collector 6 cm².
- [5] Operated under pulsed conditions: Duty cycle $\delta \leq 10\%$ and pulse width $t_p \leq 10$ ms.

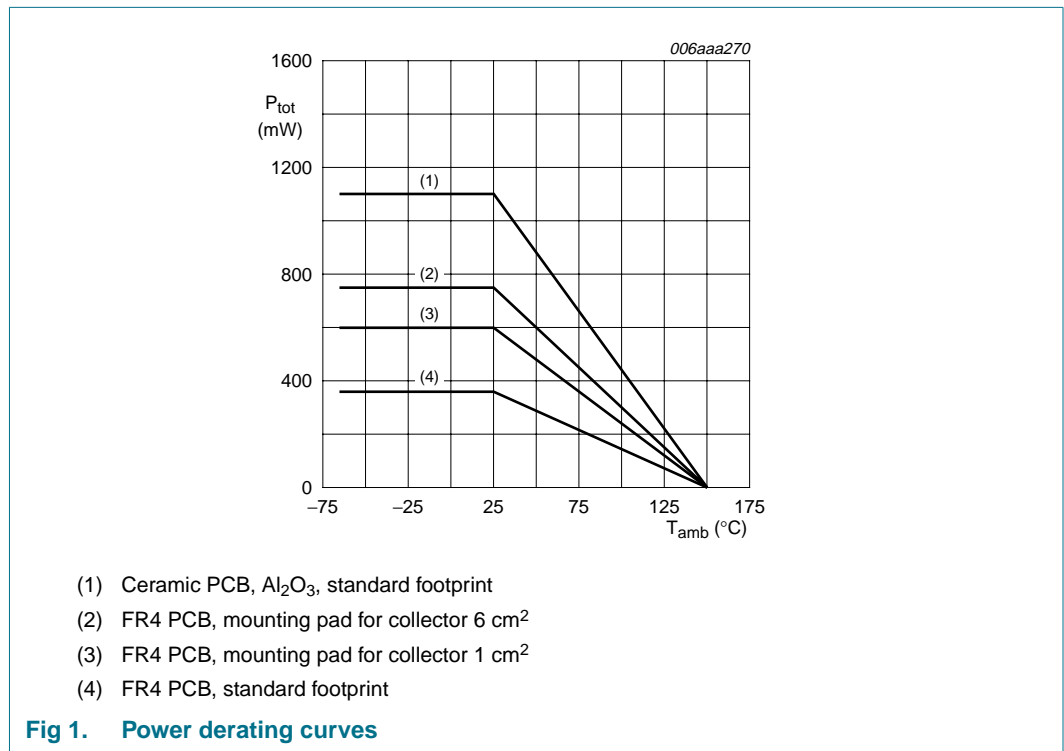

6. Thermal characteristics

Table 6. Thermal characteristics

Symbol	Parameter	Conditions	Min	Typ	Max	Unit	
$R_{th(j-a)}$	thermal resistance from junction to ambient	in free air	[1]	-	-	350	K/W
			[2]	-	-	208	K/W
			[3]	-	-	160	K/W
			[4]	-	-	113	K/W
			[1][5]	-	-	50	K/W
$R_{th(j-sp)}$	thermal resistance from junction to solder point		-	-	45	K/W	

- [1] Device mounted on an FR4 PCB, single-sided copper, tin-plated and standard footprint.
- [2] Device mounted on an FR4 PCB, single-sided copper, tin-plated, mounting pad for collector 1 cm².
- [3] Device mounted on an FR4 PCB, single-sided copper, tin-plated, mounting pad for collector 6 cm².
- [4] Device mounted on a ceramic PCB, Al₂O₃, standard footprint.
- [5] Operated under pulsed conditions: Duty cycle $\delta \leq 10\%$ and pulse width $t_p \leq 10$ ms.

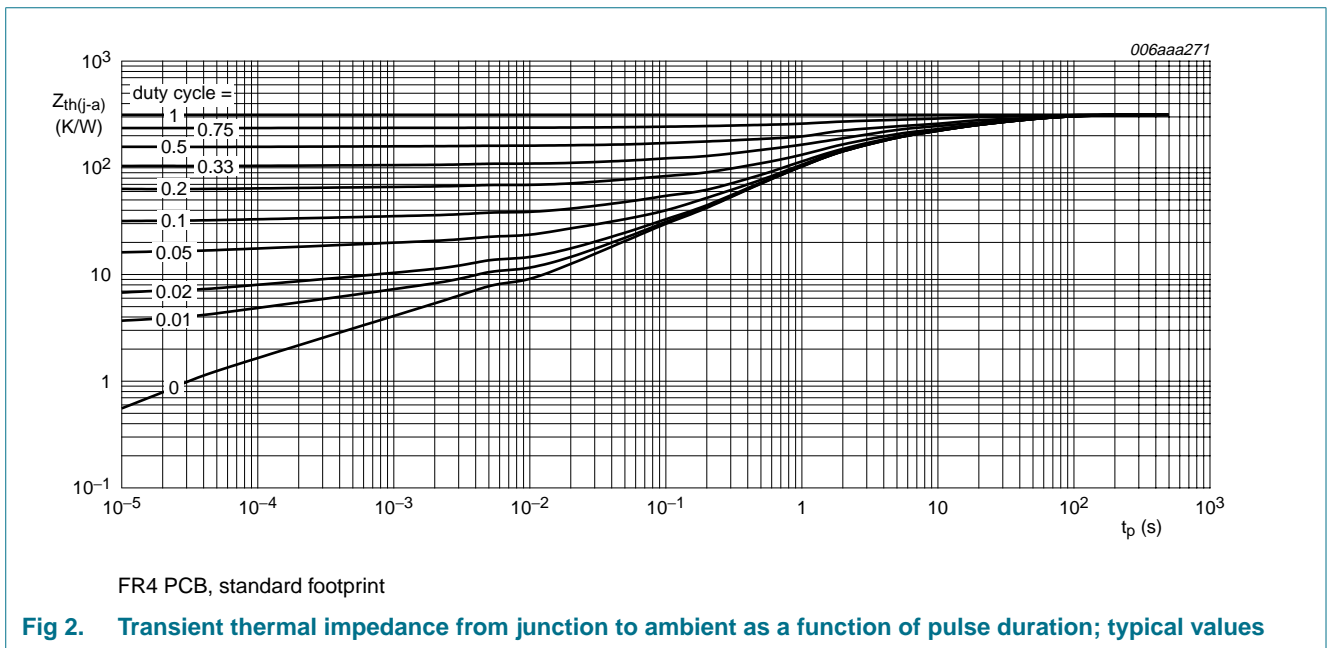

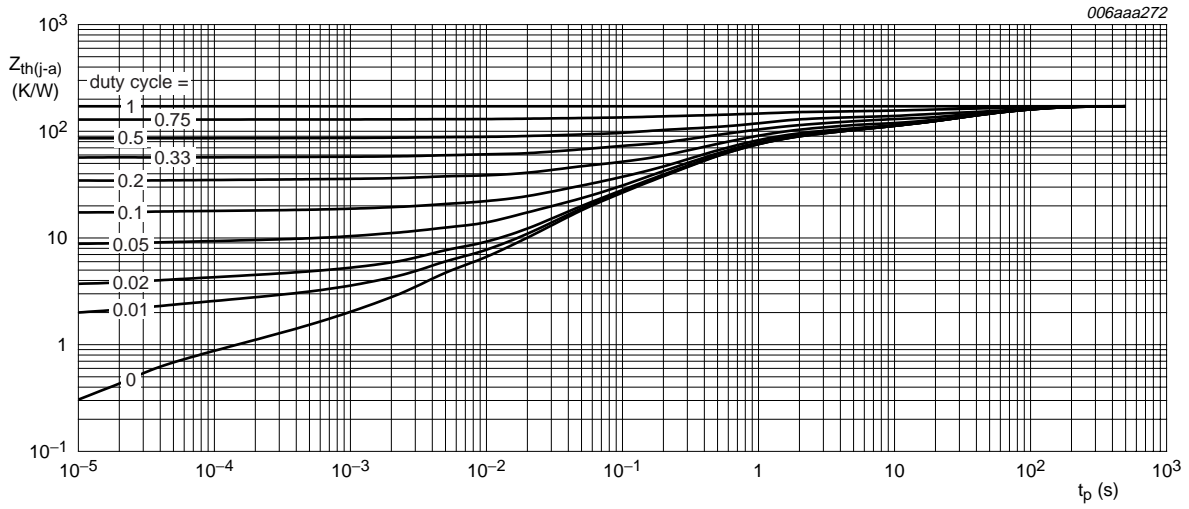

Fig 3. Transient thermal impedance from junction to ambient as a function of pulse duration; typical values

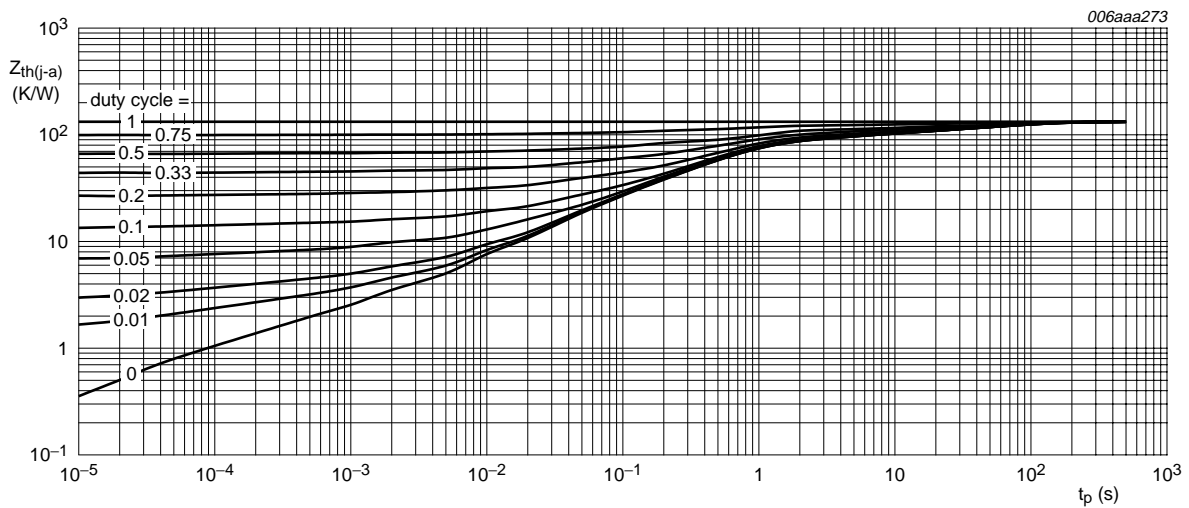

Fig 4. Transient thermal impedance from junction to ambient as a function of pulse duration; typical values

7. Characteristics

Table 7. Characteristics
 $T_{amb} = 25\text{ }^{\circ}\text{C}$ unless otherwise specified.

Symbol	Parameter	Conditions	Min	Typ	Max	Unit
I_{CBO}	collector-base cut-off current	$V_{CB} = -20\text{ V}; I_E = 0\text{ A}$	-	-	-0.1	μA
		$V_{CB} = -20\text{ V}; I_E = 0\text{ A}; T_j = 150\text{ }^{\circ}\text{C}$	-	-	-50	μA
I_{CES}	collector-emitter cut-off current	$V_{CE} = -20\text{ V}; V_{BE} = 0\text{ V}$	-	-	-0.1	μA
I_{EBO}	emitter-base cut-off current	$V_{EB} = -5\text{ V}; I_C = 0\text{ A}$	-	-	-0.1	μA
h_{FE}	DC current gain	$V_{CE} = -2\text{ V}; I_C = -0.5\text{ A}$	250	400	-	
		$V_{CE} = -2\text{ V}; I_C = -1\text{ A}$	[1] 250	400	-	
		$V_{CE} = -2\text{ V}; I_C = -2\text{ A}$	[1] 200	330	-	
		$V_{CE} = -2\text{ V}; I_C = -4\text{ A}$	[1] 120	200	-	
		$V_{CE} = -2\text{ V}; I_C = -6\text{ A}$	[1] 80	130	-	
V_{CEsat}	collector-emitter saturation voltage	$I_C = -0.5\text{ A}; I_B = -50\text{ mA}$	-	-35	-50	mV
		$I_C = -1\text{ A}; I_B = -50\text{ mA}$	-	-65	-90	mV
		$I_C = -2\text{ A}; I_B = -200\text{ mA}$	-	-110	-150	mV
		$I_C = -4\text{ A}; I_B = -400\text{ mA}$	[1] -	-200	-280	mV
		$I_C = -6\text{ A}; I_B = -600\text{ mA}$	[1] -	-300	-420	mV
R_{CEsat}	collector-emitter saturation resistance	$I_C = -4\text{ A}; I_B = -400\text{ mA}$	[1] -	50	70	$\text{m}\Omega$
V_{BEsat}	base-emitter saturation voltage	$I_C = -0.5\text{ A}; I_B = -50\text{ mA}$	-	-0.8	-0.85	V
		$I_C = -1\text{ A}; I_B = -50\text{ mA}$	-	-0.84	-0.9	V
		$I_C = -1\text{ A}; I_B = -100\text{ mA}$	[1] -	-0.84	-1	V
		$I_C = -4\text{ A}; I_B = -400\text{ mA}$	[1] -	-1.0	-1.1	V
V_{BEon}	base-emitter turn-on voltage	$V_{CE} = -2\text{ V}; I_C = -2\text{ A}$	-	-0.8	-1	V
t_d	delay time	$V_{CC} = -12.5\text{ V}; I_C = -3\text{ A}; I_{Bon} = -0.15\text{ A}; I_{Boff} = 0.15\text{ A}$	-	10	-	ns
t_r	rise time		-	35	-	ns
t_{on}	turn-on time		-	45	-	ns
t_s	storage time		-	200	-	ns
t_f	fall time		-	80	-	ns
t_{off}	turn-off time		-	280	-	ns
f_T	transition frequency	$V_{CE} = -10\text{ V}; I_C = -0.1\text{ A}; f = 100\text{ MHz}$	-	80	-	MHz
C_c	collector capacitance	$V_{CB} = -10\text{ V}; I_E = I_e = 0\text{ A}; f = 1\text{ MHz}$	-	80	-	pF

[1] Pulse test: $t_p \leq 300\text{ }\mu\text{s}$; $\delta \leq 0.02$.

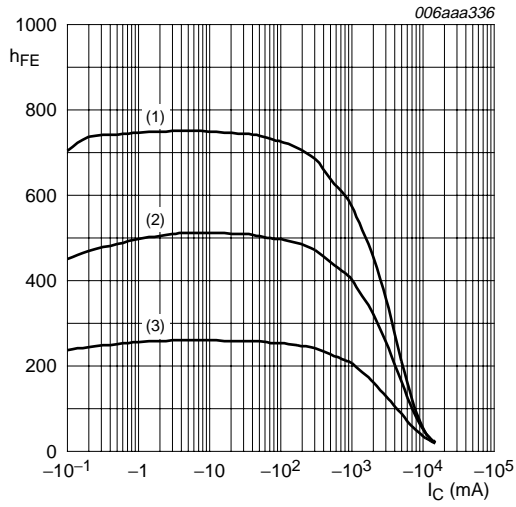

$V_{CE} = -2\text{ V}$
 (1) $T_{amb} = 100\text{ °C}$
 (2) $T_{amb} = 25\text{ °C}$
 (3) $T_{amb} = -55\text{ °C}$

Fig 5. DC current gain as a function of collector current; typical values

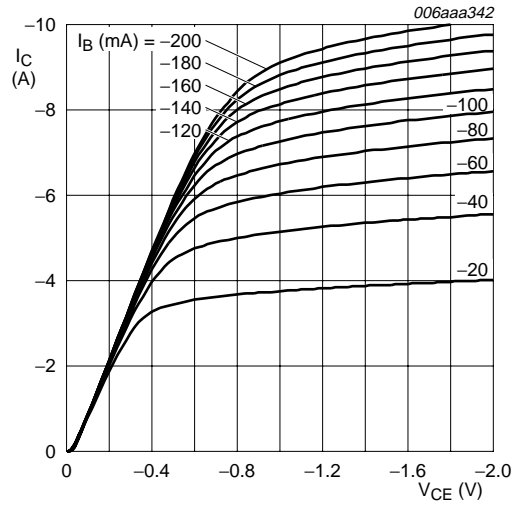

$T_{amb} = 25\text{ °C}$

Fig 6. Collector current as a function of collector-emitter voltage; typical values

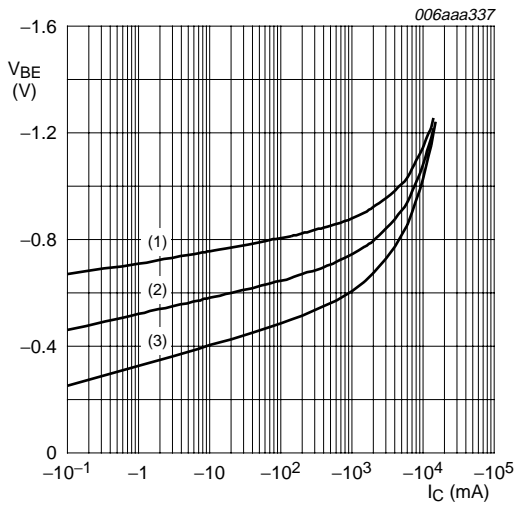

$V_{CE} = -2\text{ V}$
 (1) $T_{amb} = -55\text{ °C}$
 (2) $T_{amb} = 25\text{ °C}$
 (3) $T_{amb} = 100\text{ °C}$

Fig 7. Base-emitter voltage as a function of collector current; typical values

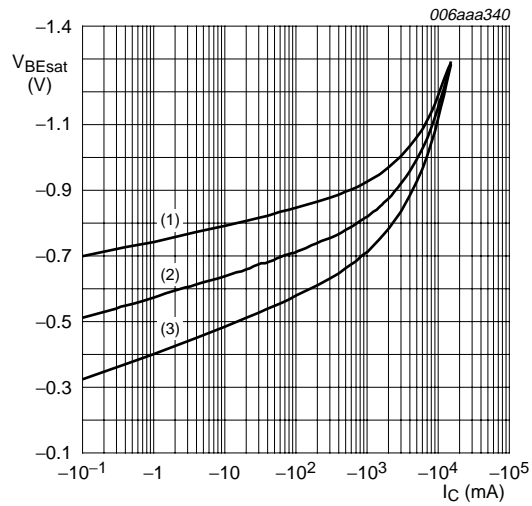

$I_C/I_B = 20$
 (1) $T_{amb} = -55\text{ °C}$
 (2) $T_{amb} = 25\text{ °C}$
 (3) $T_{amb} = 100\text{ °C}$

Fig 8. Base-emitter saturation voltage as a function of collector current; typical values

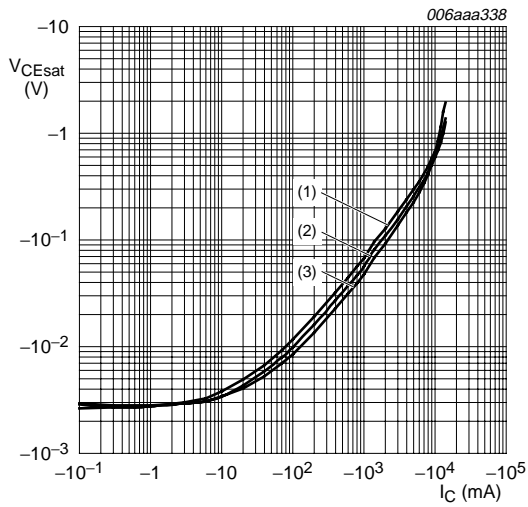

- $I_C/I_B = 20$
- (1) $T_{amb} = 100\text{ °C}$
 - (2) $T_{amb} = 25\text{ °C}$
 - (3) $T_{amb} = -55\text{ °C}$

Fig 9. Collector-emitter saturation voltage as a function of collector current; typical values

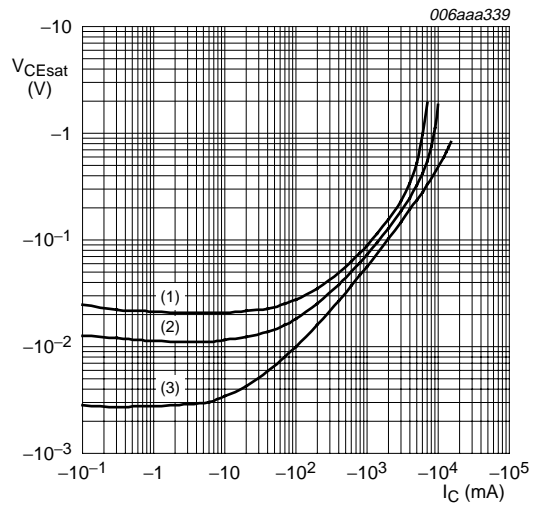

- $T_{amb} = 25\text{ °C}$
- (1) $I_C/I_B = 100$
 - (2) $I_C/I_B = 50$
 - (3) $I_C/I_B = 10$

Fig 10. Collector-emitter saturation voltage as a function of collector current; typical values

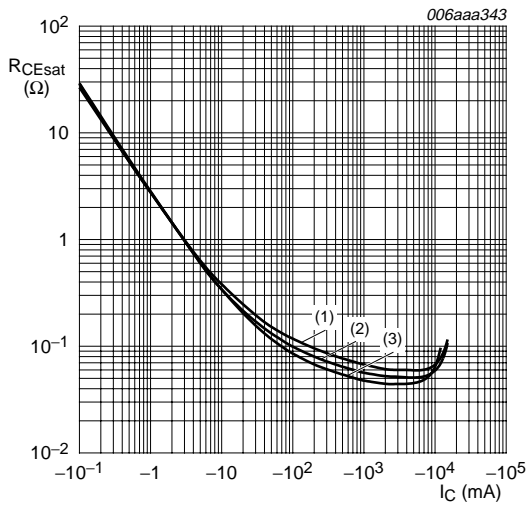

- $I_C/I_B = 20$
- (1) $T_{amb} = 100\text{ °C}$
 - (2) $T_{amb} = 25\text{ °C}$
 - (3) $T_{amb} = -55\text{ °C}$

Fig 11. Collector-emitter saturation resistance as a function of collector current; typical values

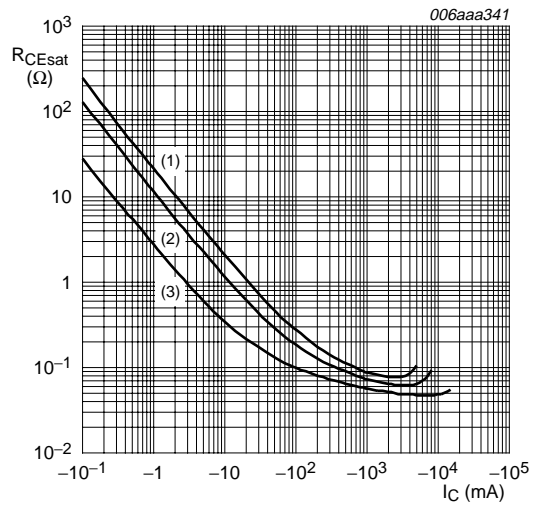

- $T_{amb} = 25\text{ °C}$
- (1) $I_C/I_B = 100$
 - (2) $I_C/I_B = 50$
 - (3) $I_C/I_B = 10$

Fig 12. Collector-emitter saturation resistance as a function of collector current; typical values

8. Test information

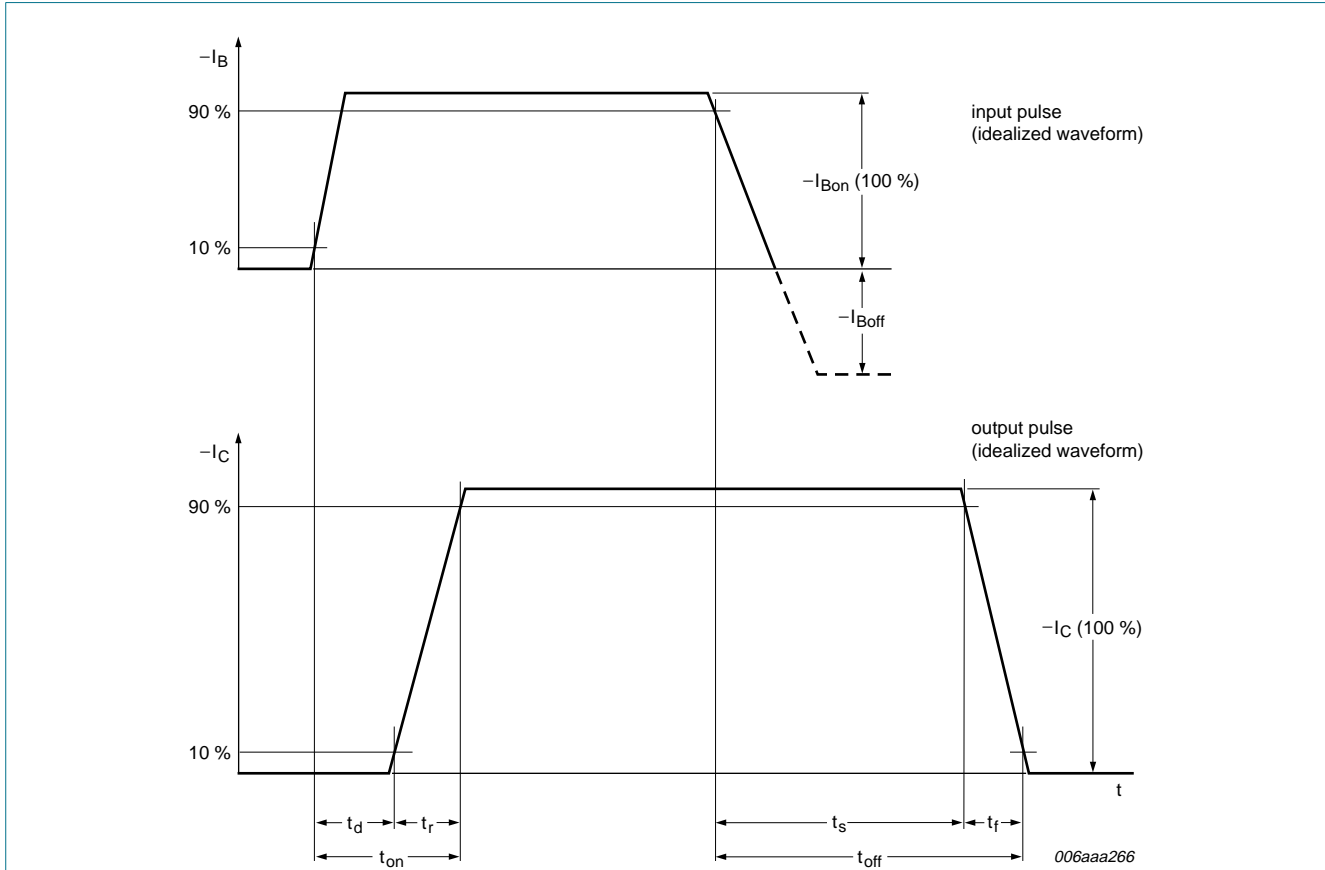
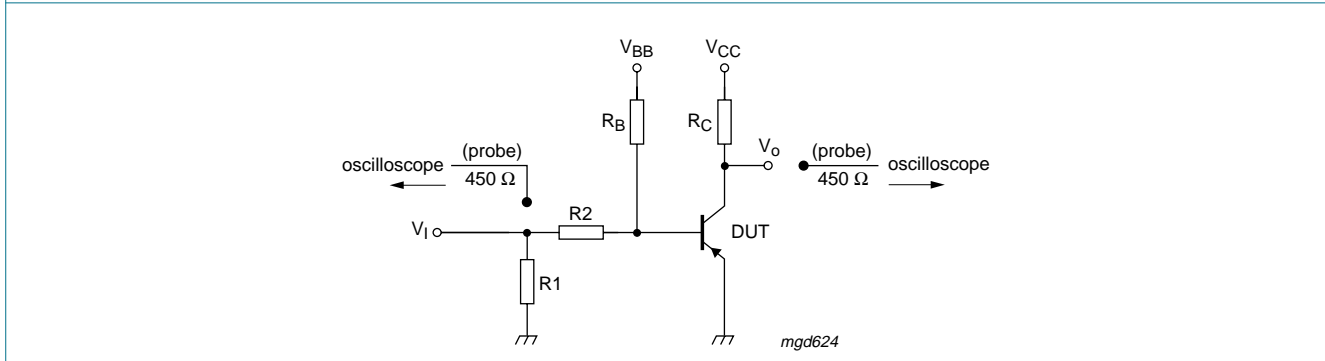

Fig 13. BISS transistor switching time definition



$V_{CC} = -12.5 \text{ V}$; $I_C = -3 \text{ A}$; $I_{Bon} = -0.15 \text{ A}$; $I_{Boff} = 0.15 \text{ A}$

Fig 14. Test circuit for switching times

9. Package outline

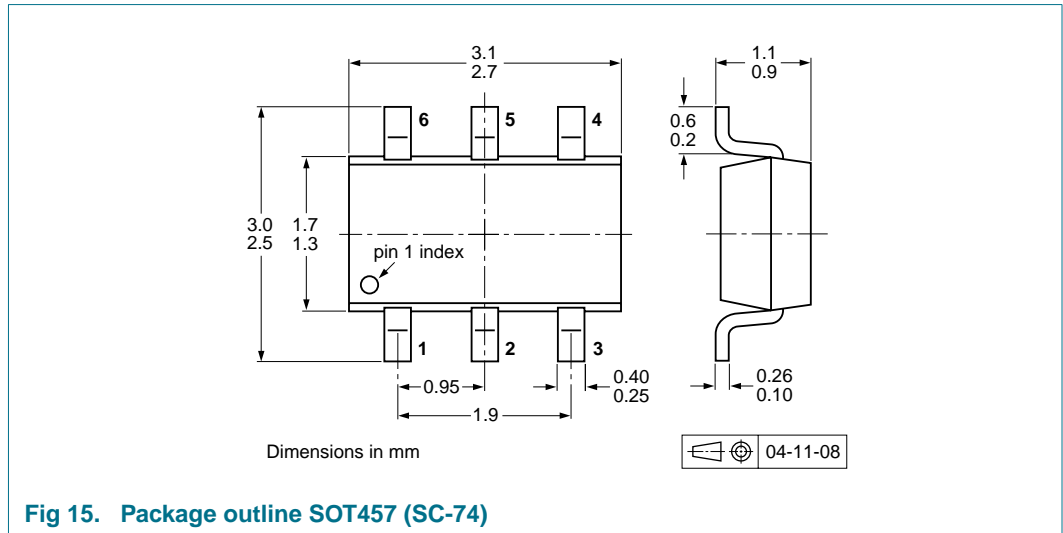

Fig 15. Package outline SOT457 (SC-74)

10. Packing information

Table 8. Packing methods

The indicated -xxx are the last three digits of the 12NC ordering code.^[1]

Type number	Package	Description	Packing quantity	
			3000	10000
PBSS5420D	SOT457	4 mm pitch, 8 mm tape and reel; T1	^[2] -115	-135
		4 mm pitch, 8 mm tape and reel; T2	^[3] -125	-165

[1] For further information and the availability of packing methods, see [Section 14](#).

[2] T1: normal taping

[3] T2: reverse taping

11. Soldering

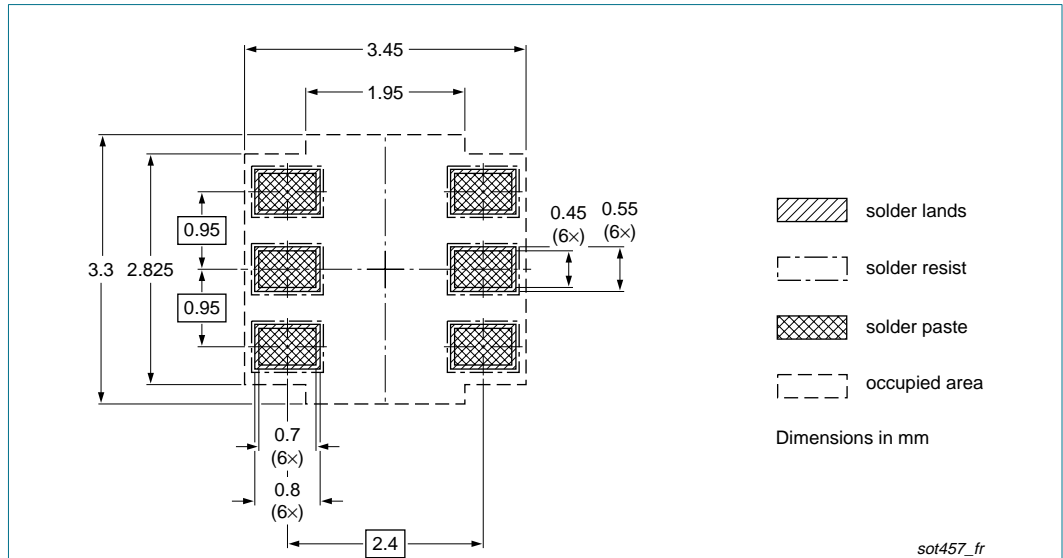

Fig 16. Reflow soldering footprint SOT457 (SC-74)

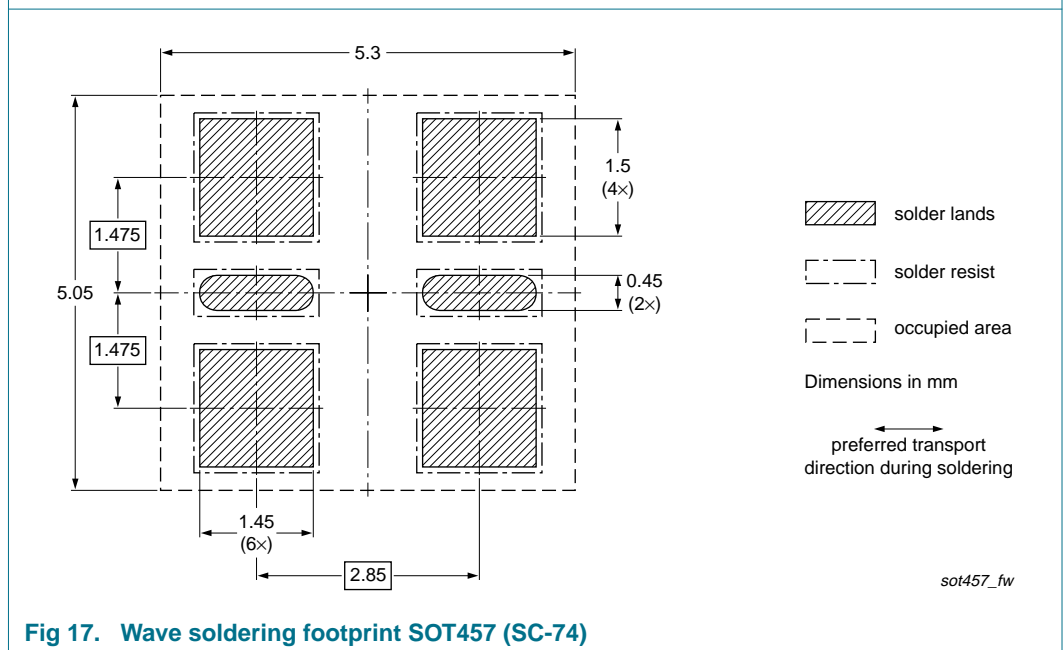

Fig 17. Wave soldering footprint SOT457 (SC-74)

12. Revision history

Table 9. Revision history

Document ID	Release date	Data sheet status	Change notice	Supersedes
PBSS5420D_2	20080929	Product data sheet	-	PBSS5420D_1
Modifications:		<ul style="list-style-type: none">• The format of this data sheet has been redesigned to comply with the new identity guidelines of NXP Semiconductors.• Legal texts have been adapted to the new company name where appropriate.• Figure 7: amended• Section 11 "Soldering": added• Section 13 "Legal information": updated		
PBSS5420D_1	20050407	Product data sheet	-	-

13. Legal information

13.1 Data sheet status

Document status ^{[1][2]}	Product status ^[3]	Definition
Objective [short] data sheet	Development	This document contains data from the objective specification for product development.
Preliminary [short] data sheet	Qualification	This document contains data from the preliminary specification.
Product [short] data sheet	Production	This document contains the product specification.

[1] Please consult the most recently issued document before initiating or completing a design.

[2] The term 'short data sheet' is explained in section "Definitions".

[3] The product status of device(s) described in this document may have changed since this document was published and may differ in case of multiple devices. The latest product status information is available on the Internet at URL <http://www.nxp.com>.

13.2 Definitions

Draft — The document is a draft version only. The content is still under internal review and subject to formal approval, which may result in modifications or additions. NXP Semiconductors does not give any representations or warranties as to the accuracy or completeness of information included herein and shall have no liability for the consequences of use of such information.

Short data sheet — A short data sheet is an extract from a full data sheet with the same product type number(s) and title. A short data sheet is intended for quick reference only and should not be relied upon to contain detailed and full information. For detailed and full information see the relevant full data sheet, which is available on request via the local NXP Semiconductors sales office. In case of any inconsistency or conflict with the short data sheet, the full data sheet shall prevail.

13.3 Disclaimers

General — Information in this document is believed to be accurate and reliable. However, NXP Semiconductors does not give any representations or warranties, expressed or implied, as to the accuracy or completeness of such information and shall have no liability for the consequences of use of such information.

Right to make changes — NXP Semiconductors reserves the right to make changes to information published in this document, including without limitation specifications and product descriptions, at any time and without notice. This document supersedes and replaces all information supplied prior to the publication hereof.

Suitability for use — NXP Semiconductors products are not designed, authorized or warranted to be suitable for use in medical, military, aircraft, space or life support equipment, nor in applications where failure or malfunction of an NXP Semiconductors product can reasonably be expected to result in personal injury, death or severe property or environmental

damage. NXP Semiconductors accepts no liability for inclusion and/or use of NXP Semiconductors products in such equipment or applications and therefore such inclusion and/or use is at the customer's own risk.

Applications — Applications that are described herein for any of these products are for illustrative purposes only. NXP Semiconductors makes no representation or warranty that such applications will be suitable for the specified use without further testing or modification.

Limiting values — Stress above one or more limiting values (as defined in the Absolute Maximum Ratings System of IEC 60134) may cause permanent damage to the device. Limiting values are stress ratings only and operation of the device at these or any other conditions above those given in the Characteristics sections of this document is not implied. Exposure to limiting values for extended periods may affect device reliability.

Terms and conditions of sale — NXP Semiconductors products are sold subject to the general terms and conditions of commercial sale, as published at <http://www.nxp.com/profile/terms>, including those pertaining to warranty, intellectual property rights infringement and limitation of liability, unless explicitly otherwise agreed to in writing by NXP Semiconductors. In case of any inconsistency or conflict between information in this document and such terms and conditions, the latter will prevail.

No offer to sell or license — Nothing in this document may be interpreted or construed as an offer to sell products that is open for acceptance or the grant, conveyance or implication of any license under any copyrights, patents or other industrial or intellectual property rights.

Quick reference data — The Quick reference data is an extract of the product data given in the Limiting values and Characteristics sections of this document, and as such is not complete, exhaustive or legally binding.

13.4 Trademarks

Notice: All referenced brands, product names, service names and trademarks are the property of their respective owners.

14. Contact information

For more information, please visit: <http://www.nxp.com>

For sales office addresses, please send an email to: salesaddresses@nxp.com

15. Contents

1 Product profile 1

1.1 General description. 1

1.2 Features 1

1.3 Applications 1

1.4 Quick reference data. 1

2 Pinning information. 2

3 Ordering information. 2

4 Marking. 2

5 Limiting values. 2

6 Thermal characteristics. 4

7 Characteristics. 6

8 Test information. 9

9 Package outline 10

10 Packing information. 10

11 Soldering 11

12 Revision history. 12

13 Legal information. 13

13.1 Data sheet status 13

13.2 Definitions. 13

13.3 Disclaimers 13

13.4 Trademarks. 13

14 Contact information. 13

15 Contents 14

Please be aware that important notices concerning this document and the product(s) described herein, have been included in section 'Legal information'.



Компания «Life Electronics» занимается поставками электронных компонентов импортного и отечественного производства от производителей и со складов крупных дистрибьюторов Европы, Америки и Азии.

С конца 2013 года компания активно расширяет линейку поставок компонентов по направлению коаксиальный кабель, кварцевые генераторы и конденсаторы (керамические, пленочные, электролитические), за счёт заключения дистрибьюторских договоров

Мы предлагаем:

- Конкурентоспособные цены и скидки постоянным клиентам.
- Специальные условия для постоянных клиентов.
- Подбор аналогов.
- Поставку компонентов в любых объемах, удовлетворяющих вашим потребностям.
- Приемлемые сроки поставки, возможна ускоренная поставка.
- Доставку товара в любую точку России и стран СНГ.
- Комплексную поставку.
- Работу по проектам и поставку образцов.
- Формирование склада под заказчика.
- Сертификаты соответствия на поставляемую продукцию (по желанию клиента).
- Тестирование поставляемой продукции.
- Поставку компонентов, требующих военную и космическую приемку.
- Входной контроль качества.
- Наличие сертификата ISO.

В составе нашей компании организован Конструкторский отдел, призванный помогать разработчикам, и инженерам.

Конструкторский отдел помогает осуществить:

- Регистрацию проекта у производителя компонентов.
- Техническую поддержку проекта.
- Защиту от снятия компонента с производства.
- Оценку стоимости проекта по компонентам.
- Изготовление тестовой платы монтаж и пусконаладочные работы.



Тел: +7 (812) 336 43 04 (многоканальный)
Email: org@lifeelectronics.ru