



Features

- Axial leaded
- Fully compatible with current industry standards
- Weldable nickel terminals
- Very low internal resistance
- Low switching temperature
- Agency recognition: RoHS compliant*

MF-VS Series - PTC Resettable Fuses

Electrical Characteristics

Model	V max. Volts	I max. Amps	I _{hold}	I _{trip}	Initial Resistance			1 Hour (R ₁) Post-Trip Resistance	Max. Time to Trip		Tripped Power Dissipation
			Amperes at 23 °C		Ohms at 23 °C			Ohms at 23 °C	Amperes at 23 °C	Seconds at 23 °C	Watts at 23 °C
			Hold	Trip	Min.	Max.	Typ.	Max.		Typ.	
MF-VS170	16	100	1.7	3.4	0.030	0.052	0.040	0.105	8.5	3.0	1.4
MF-VS210	16	100	2.1	4.7	0.018	0.030	0.022	0.060	10.0	5.0	1.5

Environmental Characteristics

Operating/Storage Temperature	-40 °C to +85 °C
Maximum Device Surface Temperature in Tripped State	125 °C
Passive Aging	+60 °C, 1000 hours..... ±10 % typical resistance change
Humidity Aging	+60 °C, 85 % R.H. 1000 hours ±10 % typical resistance change
Thermal Shock	MIL-STD-202F, Method 107G..... ±5 % typical resistance change
	+85 °C to -40 °C, 10 times
Vibration	MIL-STD-883C..... No change
	Condition A

Test Procedures And Requirements For Model MF-VS Series

Test	Test Conditions	Accept/Reject Criteria
Visual/Mech.	Verify dimensions and materials	Per MF physical description
Resistance	In still air @ 23 °C	R _{min} ≤ R ≤ R _{1max}
Time to Trip	At specified current, V _{max} , 23 °C	T ≤ max. time to trip (seconds)
Hold Current	30 min. at I _{hold}	No trip
Trip Cycle Life	V _{max} , I _{max} , 100 cycles	No arcing or burning
Trip Endurance	V _{max} , 48 hours	No arcing or burning
UL File Number	E174545 http://www.ul.com/ Follow link to Certifications, then UL File No., enter E174545	
CSA File Number	CA110338 http://directories.csa-international.org/ Under "Certification Record" and "File Number" enter 110338-0-000	
TÜV Certificate Number	R 02057213 http://www.tuvdotcom.com/ Follow link to "other certificates", enter File No. 2057213	

Thermal Derating Chart - I_{hold} (Amps)

Model	Ambient Operating Temperature								
	-40 °C	-20 °C	0 °C	23 °C	40 °C	50 °C	60 °C	70 °C	85 °C
MF-VS170	3.2	2.7	2.2	1.7	1.3	1.1	0.8	0.6	0.1
MF-VS210	4.1	3.5	2.9	2.1	1.6	1.3	1.0	0.7	0.1

*I_{trip} is approximately two times I_{hold}.

*RoHS Directive 2002/95/EC Jan. 27, 2003 including annex and RoHS Recast 2011/65/EU June 8, 2011. Specifications are subject to change without notice.

The device characteristics and parameters in this data sheet can and do vary in different applications and actual device performance may vary over time. Users should verify actual device performance in their specific applications.

Applications

Any application that requires protection at low resistances:

- Rechargeable battery packs; designed for NiMH and Li-Ion chemical characteristics
- Cellular phones
- Laptop computers

MF-VS Series - PTC Resettable Fuses **BOURNS®**

Product Dimensions

Model	A		B		C		D		F		Pkg. Style
	Min.	Max.	Min.	Max.	Min.	Max.	Min.	Max.	Min.	Max.	
MF-VS170	16.0 (0.630)	18.0 (0.709)	4.9 (0.193)	5.5 (0.217)	0.6 (0.024)	0.9 (0.035)	4.1 (0.161)	5.8 (0.228)	3.9 (0.154)	4.1 (0.161)	Std.
MF-VS170S	16.0 (0.630)	18.0 (0.709)	4.9 (0.193)	5.5 (0.217)	0.6 (0.024)	0.9 (0.035)	4.1 (0.161)	5.8 (0.228)	3.9 (0.154)	4.1 (0.161)	Std.
MF-VS210	20.9 (0.823)	23.1 (0.909)	4.9 (0.193)	5.5 (0.217)	0.6 (0.024)	0.9 (0.035)	4.1 (0.161)	5.8 (0.228)	3.9 (0.154)	4.1 (0.161)	Std.
MF-VS210L	24.0 (0.945)	26.0 (1.023)	4.9 (0.193)	5.5 (0.217)	0.6 (0.024)	0.9 (0.035)	5.0 (0.197)	7.1 (0.280)	3.9 (0.154)	4.1 (0.161)	Std.
MF-VS210S	20.9 (0.823)	23.1 (0.909)	4.9 (0.193)	5.5 (0.217)	0.6 (0.024)	0.9 (0.035)	4.1 (0.161)	5.8 (0.228)	3.9 (0.154)	4.1 (0.161)	S

Packaging: Bulk - 500 pcs. per bag. Tape and Reel - Consult factory.
Leads: 1/4 Hardened Nickel 0.125 mm (.005") nom.

DIMENSIONS: $\frac{\text{MM}}{\text{(INCHES)}}$

NOTE: All "S" style models available with 1 or 2 slots. The dimensions and shape of the leads can be modified to suit the battery pack design. All models are available without insulation wrapping.

Standard Style

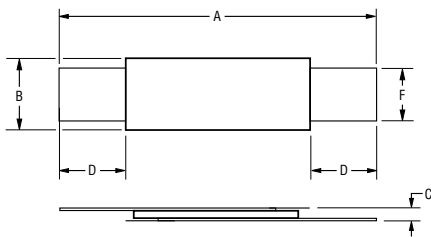

"S" Style

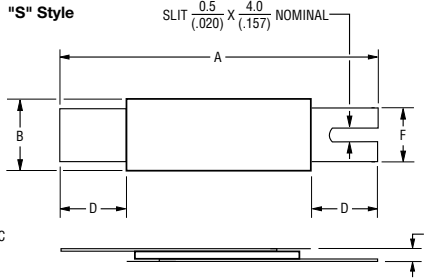

Typical Part Marking

Represents total content. Layout may vary.

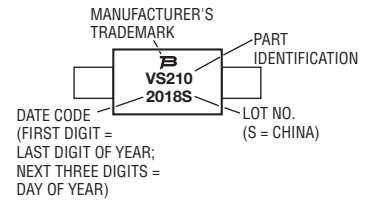

How to Order

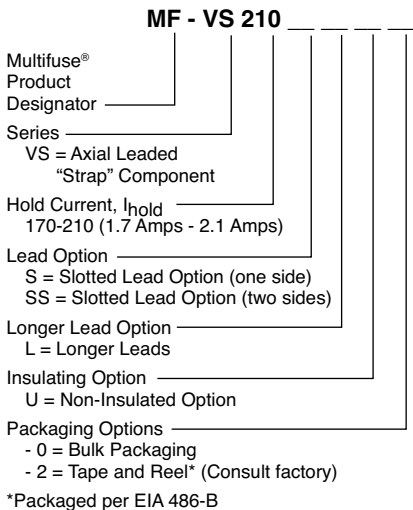

Typical Time to Trip at 23 °C

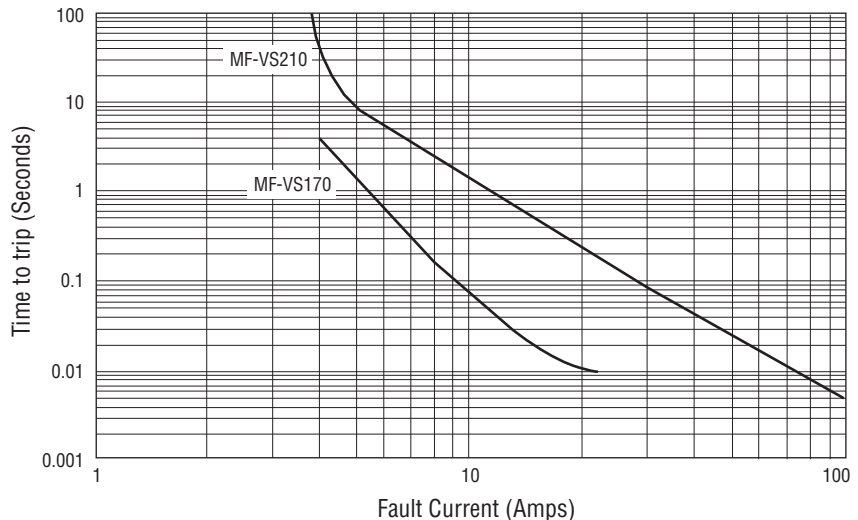

MF-VS SERIES, REV. N, 03/13

Specifications are subject to change without notice.

The device characteristics and parameters in this data sheet can and do vary in different applications and actual device performance may vary over time. Users should verify actual device performance in their specific applications.

Taped Component Dimensions

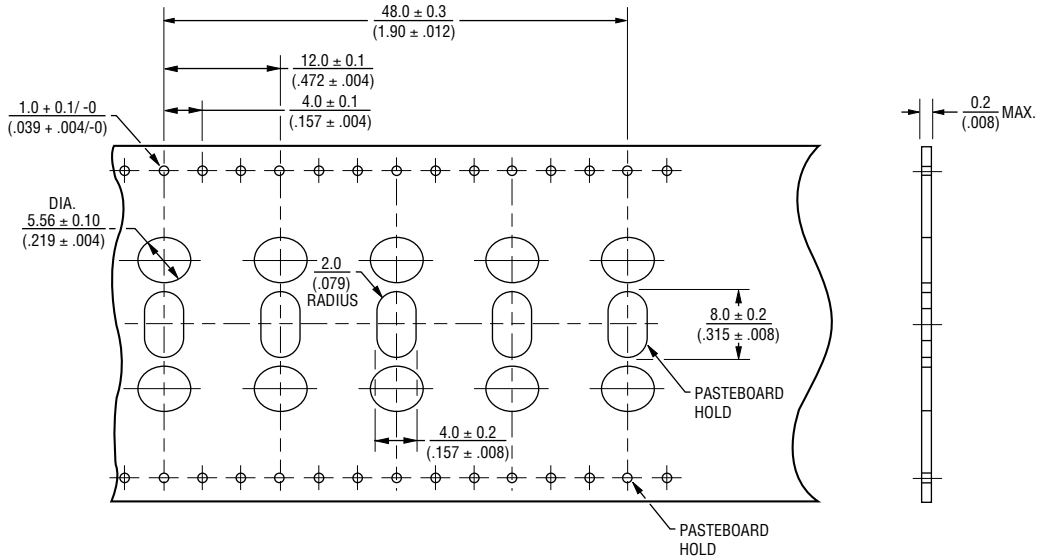

Reel Dimensions

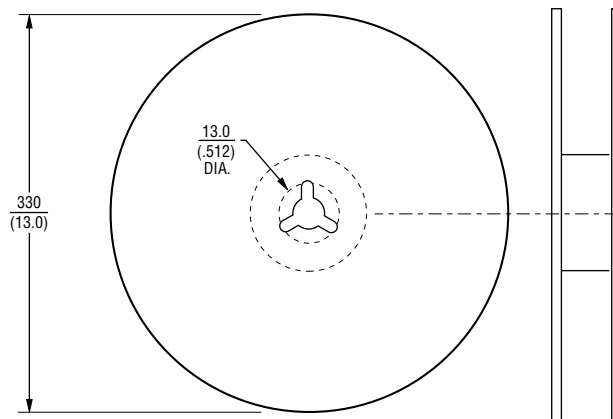

DIMENSIONS: $\frac{\text{MM}}{\text{(INCHES)}}$

Specifications are subject to change without notice. The device characteristics and parameters in this data sheet can and do vary in different applications and actual device performance may vary over time. Users should verify actual device performance in their specific applications.

Компания «Life Electronics» занимается поставками электронных компонентов импортного и отечественного производства от производителей и со складов крупных дистрибьюторов Европы, Америки и Азии.

С конца 2013 года компания активно расширяет линейку поставок компонентов по направлению коаксиальный кабель, кварцевые генераторы и конденсаторы (керамические, пленочные, электролитические), за счёт заключения дистрибьюторских договоров

Мы предлагаем:

- Конкуренспособные цены и скидки постоянным клиентам.
- Специальные условия для постоянных клиентов.
- Подбор аналогов.
- Поставку компонентов в любых объемах, удовлетворяющих вашим потребностям.
- Приемлемые сроки поставки, возможна ускоренная поставка.
- Доставку товара в любую точку России и стран СНГ.
- Комплексную поставку.
- Работу по проектам и поставку образцов.
- Формирование склада под заказчика.
- Сертификаты соответствия на поставляемую продукцию (по желанию клиента).
- Тестирование поставляемой продукции.
- Поставку компонентов, требующих военную и космическую приемку.
- Входной контроль качества.
- Наличие сертификата ISO.

В составе нашей компании организован Конструкторский отдел, призванный помогать разработчикам, и инженерам.

Конструкторский отдел помогает осуществить:

- Регистрацию проекта у производителя компонентов.
- Техническую поддержку проекта.
- Защиту от снятия компонента с производства.
- Оценку стоимости проекта по компонентам.
- Изготовление тестовой платы монтаж и пусконаладочные работы.



Тел: +7 (812) 336 43 04 (многоканальный)
Email: org@lifeelectronics.ru