

EP Series Sealed Tiny Pushbutton Switches



A
Pushbutton

Features/Benefits

- Sealed against solder & cleaning processes
- Thru-hole and surface mount models
- Snap-fitting actuator accepts standard caps
- Tape & reel packaging available
- RoHS compliant models available



Models Available

Typical Applications

- Telecommunications and networking equipment
- Computers and peripherals
- Instrumentation and controls



Specifications

CONTACT RATING: B contact material: 0.4 VA max. @ 20 V AC or DC max. See page A-13 for additional ratings.

ELECTRICAL LIFE: EP11, EP21 models: 60,000 make-and-break cycles at full load. EP12 models: 30,000 cycles.

CONTACT RESISTANCE: Below 20 mΩ typ. initial @ 2-4 V DC, 100 mA, for both silver and gold plated contacts.

INSULATION RESISTANCE: 10⁹ Ω9 min.

DIELECTRIC STRENGTH: 1000 Vrms min. @ sea level.

OPERATING TEMPERATURE: -30°C to 859°C.

SOLDERABILITY: Per MIL-STD-202F method 208D, or EIA RS-186E method 9 (1 hour steam aging).

DEGREE OF PROTECTION: IP57; Protection against harmful dust deposit, full-scale voltage protection, temporary immersion.

PACKAGING: Surface mount switches standard in anti-static tape and reel packaging per EIA 481-3, see page A-14 for drawings and reel information. Tape and cover strip are conductive for use near statically sensitive components, consult Customer Service Center.

Materials

CASE & BUSHING: High temperature material, glass filled nylon 4/6, flame retardant, heat stabilized (UL 94V-0) on EP11 / EP12 models; glass filled nylon 6/6 on EP21.

PLUNGER: Thermoplastic polyester or glass filled nylon (UL 94V-0), with internal o-ring seal. SA surface mount: High temperature material, glass filled LCP (UL 94V-0).

SWITCH SUPPORT: Brass, matte-tin plated.

CONTACTS & TERMINALS: B contact material: Copper alloy, with gold plate over nickel plate. See page A-13 for additional contact materials.

TERMINAL SEAL: Epoxy.

NOTE: Any models supplied with Q, B, P, S, R or G contact material are RoHS compliant.

NOTE: Specifications and materials listed above are for switches with standard options. For information on specific and custom switches, consult Customer Service Center.

CAUTION: PC mounting layouts and pads as shown are designed to be compatible with the latest equipment and reflow techniques. Care should be taken in the design and location of PC lands to suit individual needs. Orientation relative to reflow direction may significantly impact solder joint integrity.

Build-A-Switch

To order, simply select desired option from each category and place in the appropriate box. Available options are shown and described on pages A-10 thru A-14. For additional options not shown in catalog, consult Customer Service Center. All models are process sealed to withstand machine soldering temperatures and pressure wash cleaning methods.

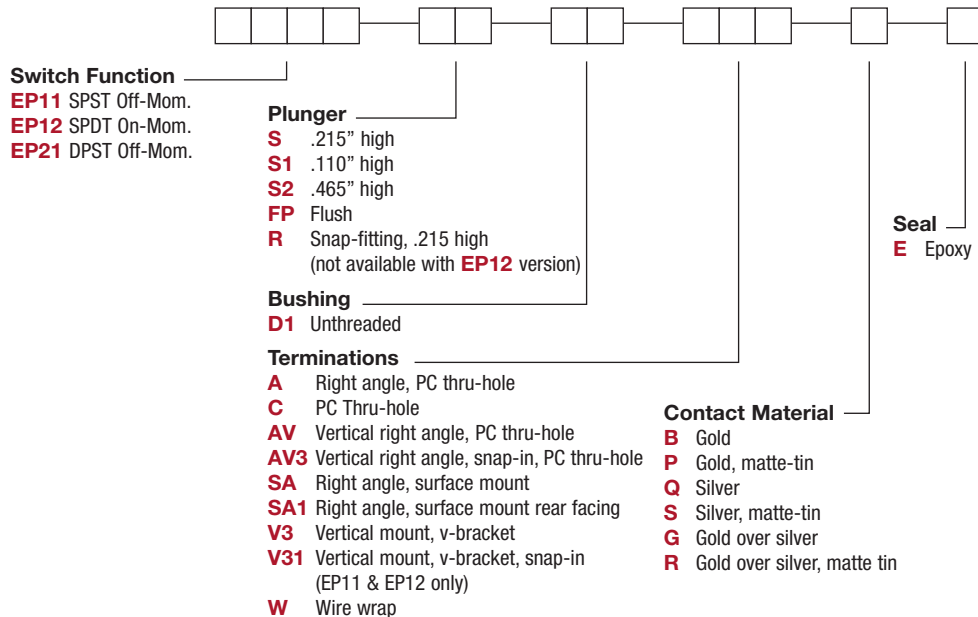



EP Series Sealed Tiny Pushbutton Switches

SWITCH FUNCTION

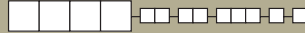

Pushbutton

NO. POLES	MODEL NO.	SWITCH FUNCTION		CONNECTED TERMINALS		SCHEMATIC
		POS. 1	POS. 2	POS. 1	POS. 2	
SP	EP11	OFF	MOM.	OPEN	1-3	SPST
	EP12	ON	MOM.	2-1	2-3	SPDT
SPDT <p>Part number shown: EP12SD1CBE</p>						
DP	EP21	OFF	MOM.	OPEN	1-3,4-6	DPST
DPST <p>Part number shown: EP21SD1CBE</p>						

MOM. = Momentary
 All models with all options when ordered with G, Q, R or S contact material.

PLUNGER



S .215" HIGH

S1 .110" HIGH

S2 .465" HIGH

FP FLUSH PLUNGER

R SNAP-FITTING

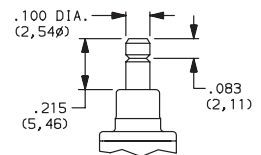
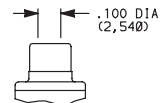
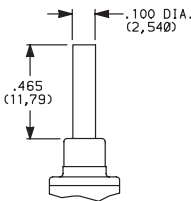
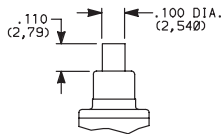
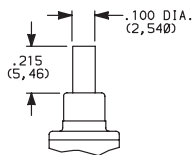

S1 & S2 actuators are not available with EP12 & EP21 models.

FP & R actuators are not available with EP21 model.
 R actuators are not available with EP12 model.

NOTE: Caps available for plunger options, see page A-14.

BUSHING



D1 UNTHREADED

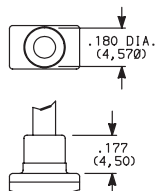

NOTE: Internal actuator o-ring standard.



4 Sep 19

Dimensions are shown: Inches (mm)
 Specifications and dimensions subject to change

EP Series Sealed Tiny Pushbutton Switches



A Pushbutton

TERMINATIONS



C PC THRU-HOLE



SP and DP

W WIRE WRAP



SP and DP

A RIGHT ANGLE, PC THRU-HOLE

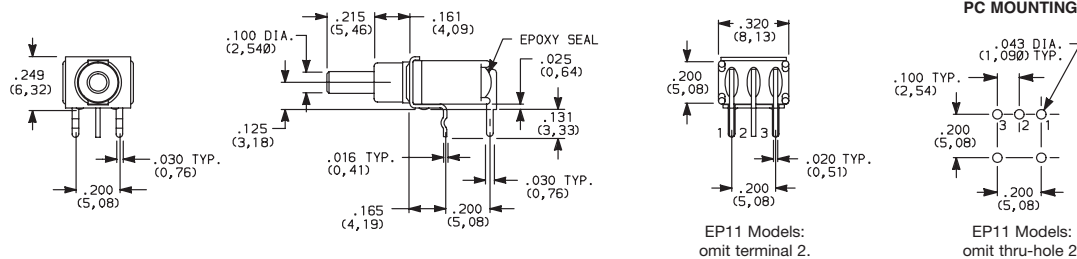

EP12SD1ABE SPDT

A RIGHT ANGLE, PC THRU-HOLE

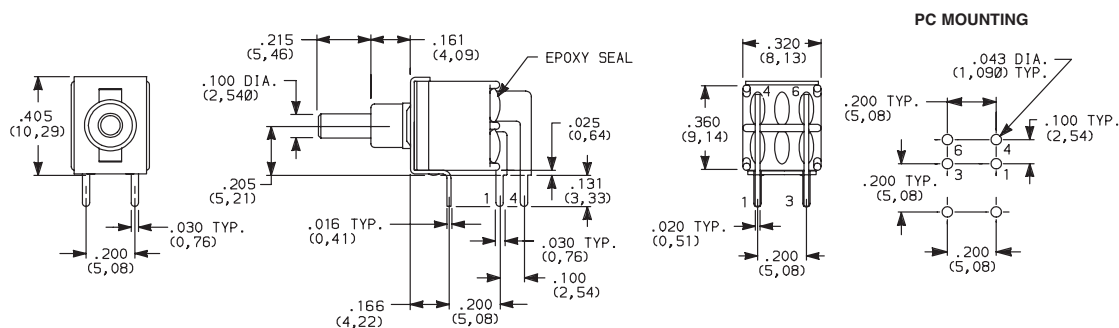

EP21SD1ABE DPST

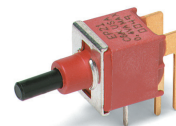

AV VERTICAL RIGHT ANGLE, PC THRU-HOLE

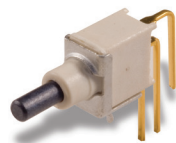
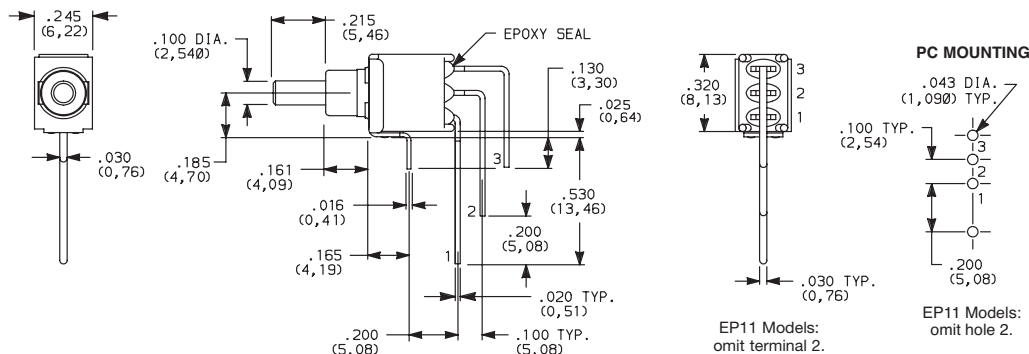

EP12SD1AVBE SPDT

NOTE: Terminal bend radii and lead-in manufacturing option.

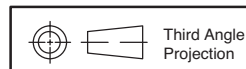

Third Angle Projection
Dimensions are shown: Inches (mm)
Specifications and dimensions subject to change





EP Series Sealed Tiny Pushbutton Switches

TERMINATIONS



Pushbutton

A

AV VERTICAL RIGHT ANGLE, THRU-HOLE

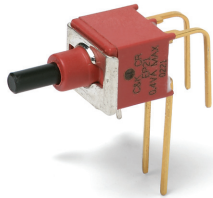

**EP21SD1AVBE
DPST**

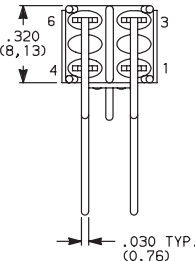
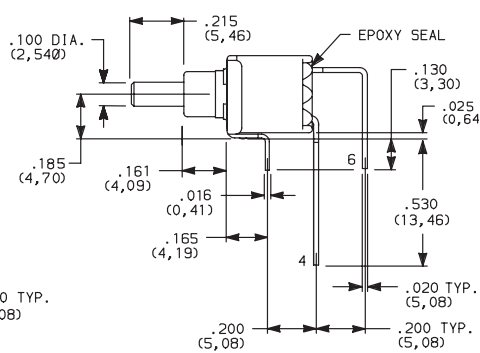
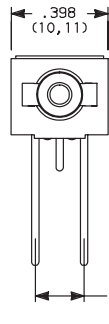

PC MOUNTING

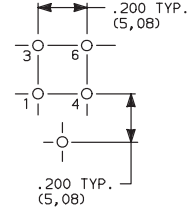

NOTE: Terminal bend radii and lead-in manufacturing option.

AV3 VERTICAL RIGHT ANGLE, SNAP-IN, PC THRU-HOLE

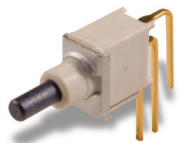

**EP12SD1AV3BE
SPST**

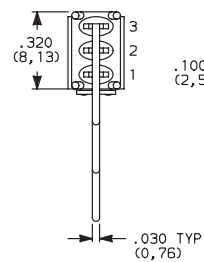
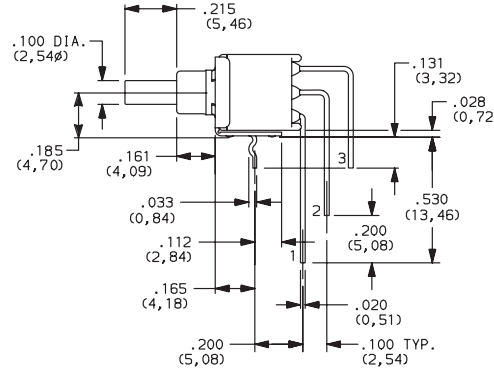
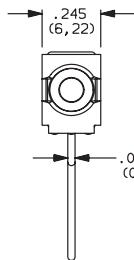

PC MOUNTING

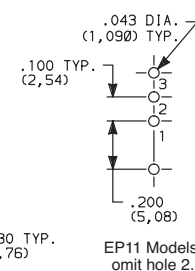

SA RIGHT ANGLE, SURFACE MOUNT



**EP12SD1SAPE
SPDT**

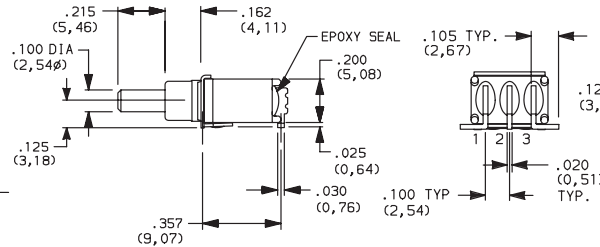
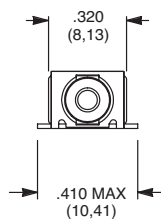

PC MOUNTING

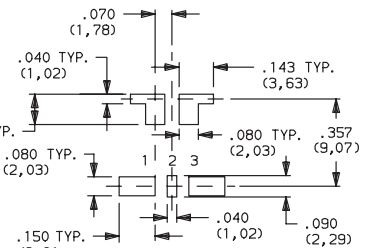

Available with P contact material only.
Not Available on DPST models.

EP11 Models:
omit terminal 2.

SA1 RIGHT ANGLE, SURFACE MOUNT



**EP12SD1SA1BE
SPDT**

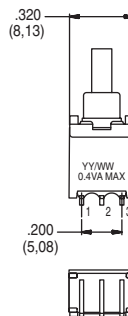
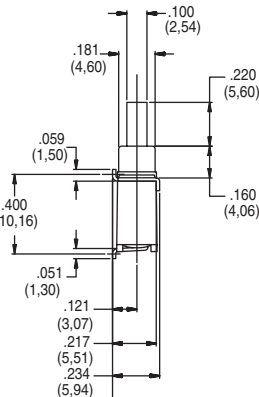
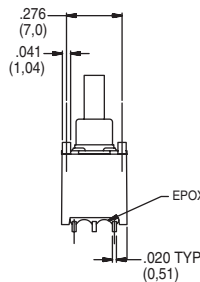

PC MOUNTING

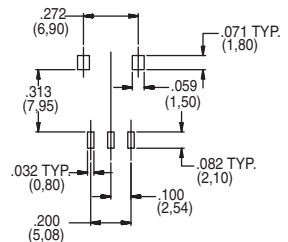

SA1 is only available with B and P contact materials.
Not Available on DPST models.

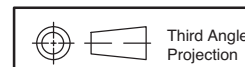

EP Series Sealed Tiny Pushbutton Switches



A
Pushbutton

TERMINATIONS

- V3** VERTICAL MOUNT, V-BRACKET
- V31** VERTICAL MOUNT, V-BRACKET, SNAP-IN

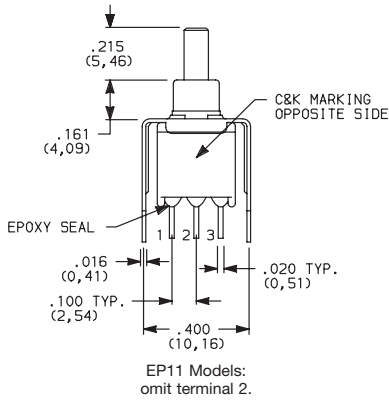

EP12SD1V3BE
SPDT

- V3** VERTICAL MOUNT, V-BRACKET

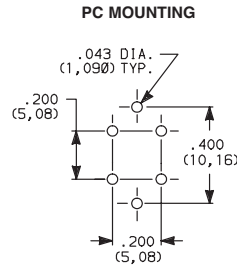
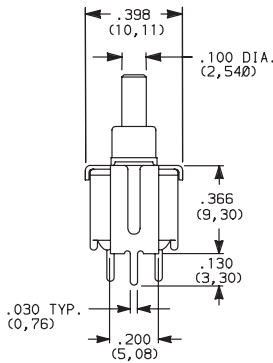
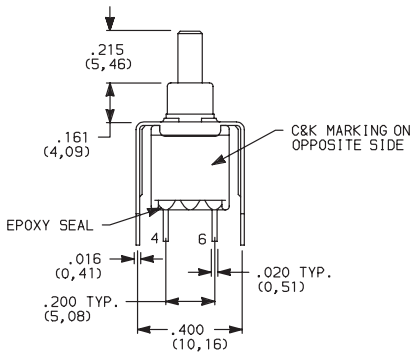

EP21SD1V3BE
DPST

CONTACT MATERIAL

OPTION CODE	CONTACT MATERIAL	TERMINAL PLATING	RATINGS	
B	GOLD ¹	GOLD ¹	LOW LEVEL/DRY CIRCUIT	0.4 VA MAX. @ 20 V AC OR DC MAX.
P		MATTE-TIN ⁶		
Q	SILVER ^{4,5}	SILVER ⁵	POWER	1 AMP @ 120 V AC OR 28 V DC.
S		MATTE-TIN ⁶		
G	GOLD OVER SILVER ^{2,3}	GOLD ³	LOW LEVEL/DRY CIRCUIT OR POWER	0.4 VA MAX @ 20 V AC OR DC MAX. OR 1 AMP @ 120 V AC OR 28 V DC.
R		MATTE-TIN ⁶		

* Note: See Technical Data section of this catalog for RoHS compliant and compatible definitions and specifications.

¹ CONTACTS & TERMINALS: Copper alloy, with gold plate over nickel plate.

⁶ TERMINALS: Copper alloy, with matte tin over nickel plate.

² END CONTACTS: Coin silver, with gold plate over nickel plate.

³ CENTER CONTACTS & ALL TERMINALS: Copper alloy, with gold plate over nickel plate.

NOTE: Any models supplied with Q, B, P, S, R or G contact material are RoHS compliant.

⁴ END CONTACTS: Coin silver, silver plated.

⁵ CENTER CONTACT & ALL TERMINALS: Copper alloy, silver plated.

All models  with all options when ordered with G, S, R or Q contact material.

SEAL

- E** EPOXY SEAL

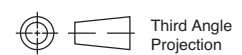
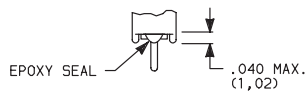

4 Sep 19

Dimensions are shown: Inches (mm)
Specifications and dimensions subject to change



EP Series Sealed Tiny Pushbutton Switches

Pushbutton
A

AVAILABLE HARDWARE

Cap

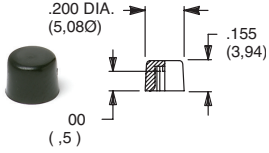

PART NO.

- 508101000** WHITE
- 508102000** BLACK
- 508103000** RED

Material: Nylon
Finish: Gloss

Not for use on S1 plunger

Cap

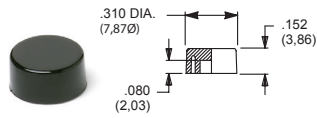

PART NO.

- 465801000** WHITE
- 465802000** BLACK
- 465803000** RED

Material: Nylon
Finish: Gloss

Not for use on S1 plunger

Cap

Compatible with snap-fitting plungers
EP11 & EP12 Models. R option only.

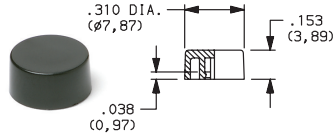

PART NO.

- 585A01000** WHITE
- 585A02000** BLACK
- 585A03000** RED

Material: Nylon
Finish: Gloss

Cap

Compatible with snap-fitting plungers
EP11 & EP12 Models. R option only.

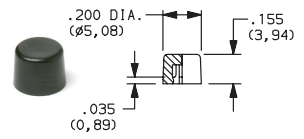

PART NO.

- 785A01000** WHITE
- 785A02000** BLACK
- 785A03000** RED

Material: Nylon
Finish: Gloss

NOTE: Other colors available, consult Customer Service Center.

TAPE & REEL

For part number EPXX-SA/SA1

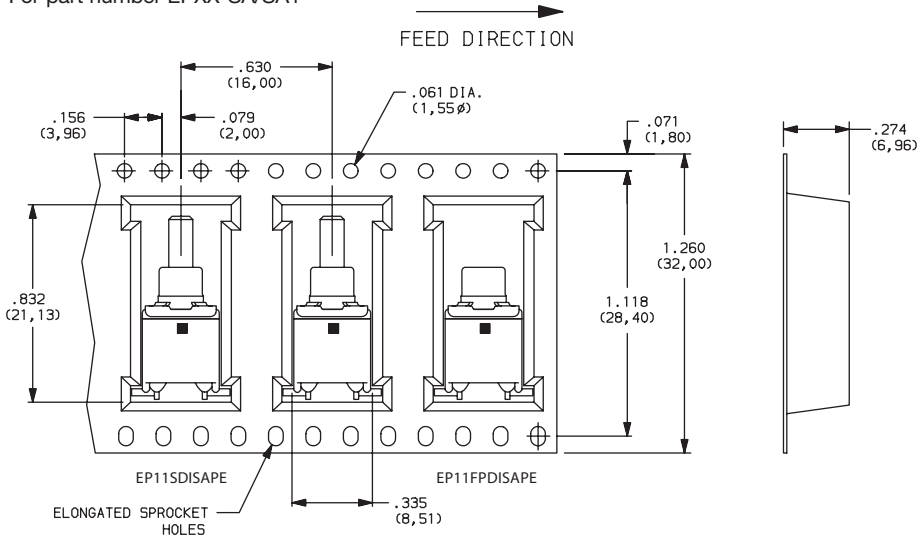

REEL INFORMATION	
OUTSIDE DIAMETER	13.00 (330,0)
PILOT HOLE	.512 (13,0)
QUANTITY PER REEL	600

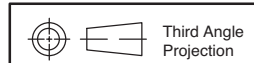

Dimensions are shown: Inches (mm)
Specifications and dimensions subject to change



4 Sep 19

Компания «Life Electronics» занимается поставками электронных компонентов импортного и отечественного производства от производителей и со складов крупных дистрибьюторов Европы, Америки и Азии.

С конца 2013 года компания активно расширяет линейку поставок компонентов по направлению коаксиальный кабель, кварцевые генераторы и конденсаторы (керамические, пленочные, электролитические), за счёт заключения дистрибьюторских договоров

Мы предлагаем:

- Конкурентоспособные цены и скидки постоянным клиентам.
- Специальные условия для постоянных клиентов.
- Подбор аналогов.
- Поставку компонентов в любых объемах, удовлетворяющих вашим потребностям.
- Приемлемые сроки поставки, возможна ускоренная поставка.
- Доставку товара в любую точку России и стран СНГ.
- Комплексную поставку.
- Работу по проектам и поставку образцов.
- Формирование склада под заказчика.
- Сертификаты соответствия на поставляемую продукцию (по желанию клиента).
- Тестирование поставляемой продукции.
- Поставку компонентов, требующих военную и космическую приемку.
- Входной контроль качества.
- Наличие сертификата ISO.

В составе нашей компании организован Конструкторский отдел, призванный помогать разработчикам, и инженерам.

Конструкторский отдел помогает осуществить:

- Регистрацию проекта у производителя компонентов.
- Техническую поддержку проекта.
- Защиту от снятия компонента с производства.
- Оценку стоимости проекта по компонентам.
- Изготовление тестовой платы монтаж и пусконаладочные работы.



Тел: +7 (812) 336 43 04 (многоканальный)

Email: org@lifeelectronics.ru