

CAN FD Transceiver with Wake-Up Pattern (WUP) Option

Features

- Supports CAN 2.0 and CAN with Flexible Data Rate (CAN FD) Physical Layer Transceiver Requirements
- Optimized for CAN FD at 2, 5 and 8 Mbps Operation
 - Maximum propagation delay: 120 ns
 - Loop delay symmetry: -10%/+10% (2 Mbps)
- MCP2542FD/4FD:
 - Wake-up on CAN activity, 3.6 μ s filter time
- MCP2542WFD/4WFD:
 - Wake-up on Pattern (WUP), as specified in ISO11898-2:2015, 3.6 μ s activity filter time
- Implements ISO11898-2:2003, ISO11898-5:2007, and ISO/DIS11898-2:2015
- Qualification: AEC-Q100 Rev. G, Grade 0 (-40°C to +150°C)
- Very Low Standby Current (4 μ A, typical)
- V_{IO} Supply Pin to Interface Directly to CAN Controllers and Microcontrollers with 1.8V to 5V I/O
- CAN Bus Pins are Disconnected when Device is Unpowered
 - An unpowered node or brown-out event will not load the CAN bus
 - Device is unpowered if V_{DD} or V_{IO} drop below its POR level
- Detection of Ground Fault:
 - Permanent Dominant detection on TXD
 - Permanent Dominant detection on bus
- Automatic Thermal Shutdown Protection
- Suitable for 12V and 24V Systems
- Meets or Exceeds Stringent Automotive Design Requirements Including "Hardware Requirements for LIN, CAN and FlexRay Interfaces in Automotive Applications", Version 1.3, May 2012
 - Conducted emissions @ 2 Mbps with Common-Mode Choke (CMC)
 - Direct Power Injection (DPI) @ 2 Mbps with CMC
- Meets SAE J2962/2 "Communication Transceiver Qualification Requirements - CAN"
 - Radiated emissions @ 2 Mbps without a CMC
- High Electrostatic Discharge (ESD) Protection on CANH and CANL, meeting IEC61000-4-2 up to \pm 13 kV
- Temperature ranges:
 - Extended (E): -40°C to +125°C
 - High (H): -40°C to +150°C

Description

The MCP2542FD/4FD and MCP2542WFD/4WFD CAN transceiver family is designed for high-speed CAN FD applications up to 8 Mbps communication speed. The maximum propagation delay was improved to support longer bus length.

The device meets the automotive requirements for CAN FD bit rates exceeding 2 Mbps, low quiescent current, electromagnetic compatibility (EMC) and electrostatic discharge (ESD).

Applications

CAN 2.0 and CAN FD networks in Automotive, Industrial, Aerospace, Medical, and Consumer applications.

Package Types



MCP2542FD/4FD, MCP2542WFD/4WFD Family Members

Device	V _{IO} pin	WUP	Description
MCP2542FD	Yes	No	
MCP2544FD	No	No	Internal level shifter on digital I/O pins
MCP2542WFD	Yes	Yes	Wake-Up on Pattern (see Section 1.6.5)
MCP2544WFD	No	Yes	Internal level shifter on digital I/O pins; Wake-Up on Pattern

Note: For ordering information, see the [Product Identification System](#) section.

MCP2542FD/4FD, MCP2542WFD/4WFD

Block Diagram



MCP2542FD/4FD, MCP2542WFD/4WFD

1.0 DEVICE OVERVIEW

The MCP2542FD/4FD and MCP2542WFD/4WFD devices serve as the interface between a CAN protocol controller and the physical bus. The devices provide differential transmit and receive capability for the CAN protocol controller. The devices are fully compatible with the ISO11898-2 and ISO11898-5 standards, and with the ISO/DIS11898-2:2015 working draft.

Excellent Loop Delay Symmetry supports data rates up to 8 Mbps for CAN FD. The maximum propagation delay was improved to support longer bus length.

Typically, each node in a CAN system must have a device to convert the digital signals generated by a CAN controller to signals suitable for transmission over the bus cabling (differential output). It also provides a buffer between the CAN controller and the high-voltage spikes that can be generated on the CAN bus by outside sources.

The MCP2542FD/4FD wakes up on CAN activity (basic wake-up). The CAN activity filter time is 3.6 μ s maximum.

The MCP2542WFD/4WFD wakes up after receiving two consecutive dominant states separated by a recessive state: WUP. The minimum duration of each dominant and recessive state is t_{FILTER} . The complete WUP has to be detected within $t_{WAKE(To)}$.

1.1 Transmitter Function

The CAN bus has two states: Dominant and Recessive. A Dominant state occurs when the differential voltage between CANH and CANL is greater than $V_{DIFF(D)(I)}$. A Recessive state occurs when the differential voltage is less than $V_{DIFF(R)(I)}$. The Dominant and Recessive states correspond to the Low and High states of the TXD input pin, respectively. However, a Dominant state initiated by another CAN node will override a Recessive state on the CAN bus.

1.2 Receiver Function

In Normal mode, the RXD output pin reflects the differential bus voltage between CANH and CANL. The Low and High states of the RXD output pin correspond to the Dominant and Recessive states of the CAN bus, respectively.

1.3 Internal Protection

CANH and CANL are protected against battery short circuits and electrical transients that can occur on the CAN bus. This feature prevents destruction of the transmitter output stage during such a fault condition.

The device is further protected from excessive current loading by thermal shutdown circuitry that disables the output drivers when the junction temperature exceeds a nominal limit of +175°C.

All other parts of the chip remain operational, and the chip temperature is lowered due to the decreased power dissipation in the transmitter outputs. This protection is essential to protect against bus line short-circuit-induced damage. Thermal protection is only active during Normal mode.

1.4 Permanent Dominant Detection

The MCP2542FD/4FD and MCP2542WFD/4WFD device prevents two conditions:

- Permanent Dominant condition on TXD
- Permanent Dominant condition on the bus

In Normal mode, if the MCP2542FD/4FD and MCP2542WFD/4WFD detects an extended Low state on the TXD input, it will disable the CANH and CANL output drivers in order to prevent the corruption of data on the CAN bus. The drivers will remain disabled until TXD goes High. The high-speed receiver is active and data on the CAN bus is received on RXD.

In Standby mode, if the MCP2542FD/4FD and MCP2542WFD/4WFD detects an extended dominant condition on the bus, it will set the RXD pin to a Recessive state. This allows the attached controller to go to Low-Power mode until the dominant issue is corrected. RXD is latched High until a Recessive state is detected on the bus and the Wake-Up function is enabled again.

1.5 Power-On Reset (POR) and Undervoltage Detection

The MCP2542FD/4FD and MCP2542WFD/4WFD have POR detection on both supply pins: VDD and VIO. Typical POR thresholds to deassert the reset are 1.2V and 3.0V for VIO and VDD, respectively.

When the device is powered on, CANH and CANL remain in a high-impedance state until VDD exceeds its undervoltage level. Once powered on, CANH and CANL will enter a high-impedance state if the voltage level at VDD drops below the undervoltage level, providing voltage brown-out protection during normal operation.

In Normal mode, the receiver output is forced to Recessive state during an undervoltage condition on VDD. In Standby mode, the low-power receiver is designed to work down to 1.7V VIO. Therefore, the low-power receiver remains operational down to VPORL on VDD (MCP2544FD and MCP2544WFD). The MCP2542FD and MCP2542WFD transfers data to the RXD pin down to 1.7V on the VIO supply.

MCP2542FD/4FD, MCP2542WFD/4WFD

1.6 Mode Control

The main difference between the MCP2542FD/4FD and MCP2542WFD/4WFD is the wake-up method.

Figure 1-1 shows the state diagram of the MCP2542FD/4FD. The devices wake up on CAN activity.

Figure 1-2 shows the state diagram of the MCP2542WFD/4WFD. The devices wake up on a WUP.

1.6.1 UNPOWERED MODE (POR)

The MCP2542FD/4FD and MCP2542WFD/4WFD enter Unpowered mode under the following conditions:

- After powering up the device, or
- If VDD drops below VPORL, or
- If VIO drops below VPORL_VIO.

In Unpowered mode, the CAN bus will be biased to ground using a high impedance. The MCP2542FD/4FD and MCP2542WFD/4WFD are not able to communicate on the bus or detect a wake-up event.

1.6.2 WAKE MODE

The MCP2542FD/4FD and MCP2542WFD/4WFD transitions from Unpowered mode to Wake mode when VDD and VIO are above their PORH levels. From Normal mode, the device will also enter Wake mode if VDD is smaller than VUVL, or if the band gap output voltage is not within valid range. Additionally, the device will transition from Standby mode to Wake mode if STBY is pulled Low.

In Wake mode, the CAN bus is biased to ground and RXD is always high.

1.6.3 NORMAL MODE

When VDD exceeds VUVH, the band gap is within valid range and TXD is High, the device transitions into Normal mode. During POR, when the microcontroller powers up, the TXD pin could be unintentionally pulled down by the microcontroller powering up. To avoid driving the bus during a POR of the microcontroller, the transceiver proceeds to Normal mode only after TXD is high.

In Normal mode, the driver block is operational and can drive the bus pins. The slopes of the output signals on CANH and CANL are optimized to reduce Electromagnetic Emissions (EME). The CAN bus is biased to VDD/2.

The high-speed differential receiver is active.

1.6.4 STANDBY MODE

The device may be placed in Standby mode by applying a high level to the STBY pin. In Standby mode, the transmitter and the high-speed part of the receiver are switched off to minimize power consumption.

The low-power receiver and the wake-up block are enabled in order to monitor the bus for activity. The CAN bus is biased to ground.

The RXD pin remains HIGH until a wake-up event has occurred.

The MCP2542FD/4FD uses Basic Wake-Up: one dominant phase for a minimum time of tFILTER will wake up the device.

The MCP2542WFD/4WFD will only wake up if it detects a complete WUP. The WUP method is described in the next section.

After a wake-up event was detected, the CAN controller gets interrupted by a negative edge on the RXD pin.

The CAN controller must put the MCP2542FD/4FD and MCP2542WFD/4WFD back into Normal mode by deasserting the STBY pin in order to enable high-speed data communication.

The CAN bus Wake-Up function requires both supply voltages, VDD and VIO, to be in valid range.

1.6.5 REMOTE WAKE-UP VIA CAN BUS (WUP)

The MCP2542WFD/4WFD wakes up from Standby/Silent mode when a dedicated wake-up pattern (WUP) is detected on the CAN bus. The wake-up pattern is specified in ISO11898-6 and ISO/DIS11898-2:2015 (see Figure 1-2 and Figure 2-11).

The Wake-Up Pattern consists of three events:

- a Dominant phase of at least tFILTER, followed by
- a Recessive phase of at least tFILTER, followed by
- a Dominant phase of at least tFILTER

The complete pattern must be received within tWAKE(TO). Otherwise, the internal wake-up logic is reset and the complete wake-up pattern must be retransmitted in order to trigger a wake-up event.

MCP2542FD/4FD, MCP2542WFD/4WFD

FIGURE 1-1: MCP2542FD/4FD STATE DIAGRAM: BASIC WAKE-UP



MCP2542FD/4FD, MCP2542WFD/4WFD

FIGURE 1-2: MCP2542WFD/4WFD STATE DIAGRAM: WAKE-UP PATTERN



MCP2542FD/4FD, MCP2542WFD/4WFD

1.7 Pin Descriptions

The description of the pins are listed in [Table 1-1](#).

TABLE 1-1: MCP2542/4FD AND MCP2542/4WFD PIN DESCRIPTIONS

MCP2542FD MCP2542WFD 3x3 DFN, 2x3TDFN	MCP2542FD MCP2542WFD SOIC	MCP2544FD MCP2544WFD 3x3 DFN, 2x3TDFN	MCP2544FD MCP2544WFD SOIC	Symbol	Pin Function
1	1	1	1	TxD	Transmit Data Input
2	2	2	2	VSS	Ground
3	3	3	3	VDD	Supply Voltage
4	4	4	4	RxD	Receive Data Output
—	—	5	5	NC	No Connect
5	5	—	—	V _{IO}	Digital I/O Supply Pin
6	6	6	6	CANL	CAN Low-Level Voltage I/O
7	7	7	7	CANH	CAN High-Level Voltage I/O
8	8	8	8	STBY	Standby Mode Input
9	—	9	—	EP	Exposed Thermal Pad

1.7.1 TRANSMITTER DATA INPUT PIN (TxD)

The CAN transceiver drives the differential output pins CANH and CANL according to TxD. It is usually connected to the transmitter data output of the CAN controller device. When TxD is Low, CANH and CANL are in the Dominant state. When TxD is High, CANH and CANL are in the Recessive state, provided that another CAN node is not driving the CAN bus with a Dominant state. TxD is connected from an internal pull-up resistor (nominal 33 k Ω) to V_{IO} in the MCP2542FD and MCP2542WFD, and to VDD in the MCP2544FD and MCP2544WFD.

1.7.2 GROUND SUPPLY PIN (VSS)

Ground supply pin.

1.7.3 SUPPLY VOLTAGE PIN (VDD)

Positive supply voltage pin. Supplies transmitter and receiver, including the wake-up receiver.

1.7.4 RECEIVER DATA OUTPUT PIN (RxD)

RxD is a CMOS-compatible output that drives High or Low depending on the differential signals on the CANH and CANL pins, and is usually connected to the receiver data input of the CAN controller device. RxD is High when the CAN bus is Recessive, and Low in the Dominant state. RxD is supplied by V_{IO} in the MCP2542FD and MCP2542WFD and by VDD in the MCP2544FD and MCP2544WFD.

1.7.5 NC PIN (MCP2544FD AND MCP2544WFD)

No Connect. This pin can be left open or connected to VSS.

1.7.6 V_{IO} PIN (MCP2542FD AND MCP2542WFD)

Supply for digital I/O pins. In the MCP2544FD and MCP2544WFD, the supply for the digital I/O (TxD, RxD and STBY) is internally connected to VDD.

1.7.7 DIGITAL I/O

The MCP2542FD/4FD and MCP2542WFD/4WFD enable easy interfacing to MCU with I/O ranges from 1.8V to 5V.

1.7.7.1 MCP2544FD and MCP2544WFD

The V_{IH(MIN)} and V_{IL(MAX)} for STBY and TxD are independent of VDD. They are set at levels that are compatible with 3V and 5V microcontrollers.

The RxD pin is always driven to VDD, therefore a 3V microcontroller will need a 5V tolerant input.

1.7.7.2 MCP2542FD and MCP2542WFD

V_{IH} and V_{IL} for STBY and TxD depend on V_{IO}. The RxD pin is driven to V_{IO}.

1.7.8 CAN LOW PIN (CANL)

The CANL output drives the Low side of the CAN differential bus. This pin is also tied internally to the receive input comparator. CANL disconnects from the bus when MCP2542FD/4FD and MCP2542WFD/4WFD are not powered.

1.7.9 CAN HIGH PIN (CANH)

The CANH output drives the high side of the CAN differential bus. This pin is also tied internally to the receive input comparator. CANH disconnects from the bus when MCP2542FD/4FD and MCP2542WFD/4WFD are not powered.

MCP2542FD/4FD, MCP2542WFD/4WFD

1.7.10 STANDBY MODE INPUT PIN (STBY)

This pin selects between Normal or Standby mode. In Standby mode, the transmitter and high-speed receiver are turned off, only the low-power receiver and wake-up filter are active. STBY is connected from an internal MOS pull-up resistor to V_{IO} in the MCP2542FD and MCP2542WFD, and to V_{DD} in the MCP2544FD and MCP2544WFD. The value of the MOS pull-up resistor depends on the supply voltage. Typical values are 660 k Ω for 5V, 1.1 M Ω for 3.3V and 4.4 M Ω for 1.8V.

1.7.11 EXPOSED THERMAL PAD (EP)

It is recommended to connect this pad to V_{SS} to enhance electromagnetic immunity and thermal resistance.

MCP2542FD/4FD, MCP2542WFD/4WFD

1.8 Typical Applications

In order to meet the EMC/EMI requirements, a Common Mode Choke (CMC) may be required for data rates greater than 1 Mbps. [Figure 1-3](#) and [Figure 1-4](#) illustrate examples of typical applications of the devices.

FIGURE 1-3: MCP2544WFD WITH NC AND SPLIT TERMINATION



FIGURE 1-4: MCP2542FD WITH V_{IO} PIN



MCP2542FD/4FD, MCP2542WFD/4WFD

NOTES:

MCP2542FD/4FD, MCP2542WFD/4WFD

2.0 ELECTRICAL CHARACTERISTICS

2.1 Terms and Definitions

A number of terms are defined in ISO-11898 that are used to describe the electrical characteristics of a CAN transceiver device. These terms and definitions are summarized in this section.

2.1.1 BUS VOLTAGE

V_{CANL} and V_{CANH} denote the voltages of the bus line wires CANL and CANH relative to the ground of each individual CAN node.

2.1.2 COMMON MODE BUS VOLTAGE RANGE

Boundary voltage levels of V_{CANL} and V_{CANH} with respect to ground, for which proper operation will occur, if up to the maximum number of CAN nodes are connected to the bus.

2.1.3 DIFFERENTIAL INTERNAL CAPACITANCE, C_{DIFF} (OF A CAN NODE)

Capacitance seen between CANL and CANH during the Recessive state when the CAN node is disconnected from the bus (see [Figure 2-1](#)).

2.1.4 DIFFERENTIAL INTERNAL RESISTANCE, R_{DIFF} (OF A CAN NODE)

Resistance seen between CANL and CANH during the Recessive state when the CAN node is disconnected from the bus (see [Figure 2-1](#)).

2.1.5 DIFFERENTIAL VOLTAGE, V_{DIFF} (OF CAN BUS)

Differential voltage of the two-wire CAN bus, with value equal to $V_{DIFF} = V_{CANH} - V_{CANL}$.

2.1.6 INTERNAL CAPACITANCE, C_{IN} (OF A CAN NODE)

Capacitance seen between CANL (or CANH) and ground during the Recessive state when the CAN node is disconnected from the bus (see [Figure 2-1](#)).

2.1.7 INTERNAL RESISTANCE, R_{IN} (OF A CAN NODE)

Resistance seen between CANL (or CANH) and ground during the Recessive state when the CAN node is disconnected from the bus (see [Figure 2-1](#)).

FIGURE 2-1: PHYSICAL LAYER DEFINITIONS

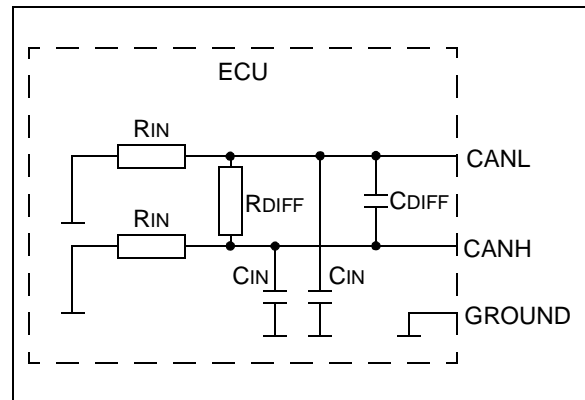

MCP2542FD/4FD, MCP2542WFD/4WFD

2.2 Absolute Maximum Ratings†

VDD	7.0V
VIO	7.0V
DC Voltage at TXD, RXD, STBY and VSS	-0.3V to VIO + 0.3V
DC Voltage at CANH and CANL	-58V to +58V
Transient Voltage on CANH and CANL (ISO-7637) (Figure 2-5)	-150V to +100V
Differential Bus Input Voltage VDIFF(I) (t = 60 days, continuous)	-5V to +10V
Differential Bus Input Voltage VDIFF(I) (1000 pulses, t = 0.1 ms, VCANH = +18V)	+17V
Dominant State Detection VDIFF(I) (10000 pulses, t = 1 ms)	+9V
Storage temperature	-55°C to +150°C
Operating ambient temperature	-40°C to +150°C
Virtual Junction Temperature, TVJ (IEC60747-1)	-40°C to +190°C
Soldering temperature of leads (10 seconds)	+300°C
ESD protection on CANH and CANL pins (IEC 61000-4-2)	±13 kV
ESD protection on CANH and CANL pins (IEC 801; Human Body Model)	±8 kV
ESD protection on all other pins (IEC 801; Human Body Model)	±4 kV
ESD protection on all pins (IEC 801; Machine Model)	±400V
ESD protection on all pins (IEC 801; Charge Device Model)	±750V

† **Notice:** Stresses above those listed under “Maximum ratings” may cause permanent damage to the device. This is a stress rating only and functional operation of the device at those or any other conditions above those indicated in the operational listings of this specification is not implied. Exposure to maximum rating conditions for extended periods may affect device reliability.

MCP2542FD/4FD, MCP2542WFD/4WFD

TABLE 2-1: DC CHARACTERISTICS

DC Specifications	Electrical Characteristics: Unless otherwise indicated, Extended (E): TAMB = -40°C to +125°C and High (H): TAMB = -40°C to +150°C; VDD = 4.5V to 5.5V, VIO = 1.7V to 5.5V (Note 2), RL = 60Ω, CL = 100 pF; unless otherwise specified.					
Parameter	Sym.	Min.	Typ.	Max.	Units	Conditions
Supply						
VDD Pin						
Voltage Range	VDD	4.5	—	5.5	V	
Supply Current	IDD	—	2.5	5	mA	Recessive; VTXD = VDD
		—	55	70		Dominant; VTXD = 0V
Standby Current	IDDS	—	4	15	μA	MCP2544FD and MCP2544WFD, Bus Recessive
		—	4	16		MCP2542FD and MCP2542WFD, Includes IIO
Maximum Supply Current	IDDMAX	—	95	140	mA	Fault condition: VTXD = VSS; VCANH = VCANL = -5V to +18V (Note 1)
High Level of the POR Comparator for VDD	VPORH	—	3.0	3.95	V	Note 1
Low Level of the POR Comparator for VDD	VPORL	1.0	2.0	3.2	V	Note 1
Hysteresis of POR Comparator for VDD	VPORD	0.2	0.9	2.0	V	Note 1
High Level of the UV Comparator for VDD	VUVH	4.0	4.25	4.4	V	
Low Level of the UV Comparator for VDD	VUVL	3.6	3.8	4.0	V	
Hysteresis of UV comparator	VUVD	—	0.4	—	V	Note 1
VIO Pin						
Digital Supply Voltage Range	VIO	1.7	—	5.5	V	
Supply Current on VIO	IIO	—	7	20	μA	Recessive; VTXD = VIO
		—	200	400		Dominant; VTXD = 0V
Standby Current	IDDS	—	0.3	2	μA	Bus Recessive (Note 1)
High Level of the POR Comparator for VIO	VPORH_VIO	0.8	1.2	1.7	V	
Low Level of the POR Comparator for VIO	VPORL_VIO	0.7	1.1	1.4	V	
Hysteresis of POR Comparator for VIO	VPORD_VIO	—	0.2	—	V	
Bus Line (CANH; CANL) Transmitter						
CANH; CANL: Recessive Bus Output Voltage	Vo(R)	2.0	0.5 VDD	3.0	V	VTXD = VDD; No load
CANH; CANL: Bus Output Voltage in Standby	Vo(S)	-0.1	0.0	+0.1	V	STBY = VTXD = VDD; No load

Note 1: Characterized; not 100% tested.

Note 2: Only MCP2542FD and MCP2542WFD have a VIO pin. For the MCP2544FD and MCP2544WFD, VIO is internally connected to VDD.

Note 3: -12V to 12V is ensured by characterization, and tested from -2V to 7V.

MCP2542FD/4FD, MCP2542WFD/4WFD

TABLE 2-1: DC CHARACTERISTICS (CONTINUED)

DC Specifications		Electrical Characteristics: Unless otherwise indicated, Extended (E): TAMB = -40°C to +125°C and High (H): TAMB = -40°C to +150°C; VDD = 4.5V to 5.5V, VIO = 1.7V to 5.5V (Note 2), RL = 60Ω, CL = 100 pF; unless otherwise specified.				
Parameter	Sym.	Min.	Typ.	Max.	Units	Conditions
Recessive Output Current	IO(R)	-5	—	+5	mA	-24V < VCAN < +24V
CANH: Dominant Output Voltage	VO(D)	2.75	3.50	4.50	V	TXD = 0; RL = 50 to 65Ω
CANL: Dominant Output Voltage		0.50	1.50	2.25		RL = 50Ω to 65Ω
Driver Symmetry (VCANH+VCANL)/VDD	VSYM	0.9	1.0	1.1	V	1 MHz square wave, Recessive and Dominant states, and transition (Note 1)
Dominant: Differential Output Voltage	VO(DIFF)(D)	1.5	2.0	3.0	V	VTXD = VSS; RL = 50Ω to 65Ω (Figure 2-2, Figure 2-4, Section 3.0) (Note 1)
		1.4	2.0	3.3		VTXD = VSS; RL = 45Ω to 70Ω (Figure 2-2, Figure 2-4, Section 3.0) (Note 1)
		1.3	2.0	3.3		VTXD = VSS; RL = 40Ω to 75Ω (Figure 2-2, Figure 2-4)
		1.5	—	5.0		VTXD = VSS; RL = 2240Ω (Figure 2-2, Figure 2-4, Section 3.0) (Note 1)
Recessive: Differential Output Voltage	VO(DIFF)(R)	-500	0	50	mV	VTXD = VDD, no load, Normal. (Figure 2-2, Figure 2-4)
	VO(DIFF)(S)	-200	0	200		VTXD = VDD, no load, Standby. Figure 2-2, Figure 2-4
CANH: Short-Circuit Output Current	IO(SC)	-115	-85	—	mA	VTXD = VSS; VCANH = -3V; CANL: floating
CANL: Short Circuit Output Current		—	75	+115	mA	VTXD = VSS; VCANL = +18V; CANH: floating
Bus Line (CANH; CANL) Receiver						
Recessive Differential Input Voltage	VDIFF(R)(I)	-4.0	—	+0.5	V	Normal Mode; -12V < V(CANH, CANL) < +12V; see Figure 2-6 (Note 3)
		-4.0	—	+0.4		Standby Mode; -12V < V(CANH, CANL) < +12V; see Figure 2-6 (Note 3)
Dominant Differential Input Voltage	VDIFF(D)(I)	0.9	—	9.0	V	Normal Mode; -12V < V(CANH, CANL) < +12V; see Figure 2-6 (Note 3)
		1.1	—	9.0		Standby Mode; -12V < V(CANH, CANL) < +12V; see Figure 2-6 (Note 3)

Note 1: Characterized; not 100% tested.

Note 2: Only MCP2542FD and MCP2542WFD have a VIO pin. For the MCP2544FD and MCP2544WFD, VIO is internally connected to VDD.

Note 3: -12V to 12V is ensured by characterization, and tested from -2V to 7V.

MCP2542FD/4FD, MCP2542WFD/4WFD

TABLE 2-1: DC CHARACTERISTICS (CONTINUED)

DC Specifications	Electrical Characteristics: Unless otherwise indicated, Extended (E): TAMB = -40°C to +125°C and High (H): TAMB = -40°C to +150°C; VDD = 4.5V to 5.5V, VIO = 1.7V to 5.5V (Note 2), RL = 60Ω, CL = 100 pF; unless otherwise specified.					
Parameter	Sym.	Min.	Typ.	Max.	Units	Conditions
Differential Receiver Threshold	VTH(DIFF)	0.5	0.7	0.9	V	Normal Mode; -12V < V(CANH, CANL) < +12V; see Figure 2-6 (Note 3)
		0.4	0.7	0.9		Standby Mode; -12V < V(CANH, CANL) < +12V; see Figure 2-6 (Note 3)
Differential Input Hysteresis	VHYS(DIFF)	30	—	200	mV	Normal mode, see Figure 2-6, (Note 1)
Single Ended Input Resistance	RCAN_H, RCAN_L	6	—	50	kΩ	Note 1
Internal Resistance Matching $mR=2*(RCANH-RCANL)/(RCANH+RCANL)$	mR	-3	0	+3	%	VCANH = VCANL (Note 1)
Differential Input Resistance	RDIFF	12	25	100	kΩ	Note 1
Internal Capacitance	CIN	—	20	—	pF	1 Mbps (Note 1)
Differential Internal Capacitance	CDIFF	—	10	—	pF	1 Mbps (Note 1)
CANH, CANL: Input Leakage	ILI	-5	—	+5	μA	VDD = VTXD = VSTBY = 0V. For MCP2542FD and MCP2542WFD, VIO = 0V. VCANH = VCANL = 5 V.
Digital Input Pins (Txd, STBY)						
High-Level Input Voltage	VIH	2.0	—	VIO + 0.3	V	MCP2544FD and MCP2544WFD
		0.7 VIO	—	VIO + 0.3		MCP2542FD and MCP2542WFD
Low-Level Input Voltage	VIL	-0.3	—	0.8	V	MCP2544FD and MCP2544WFD
		-0.3	—	0.3VIO		MCP2542FD and MCP2542WFD
High-Level Input Current	IiH	-1	—	+1	μA	
TXD: Low-Level Input Current	IiL(TXD)	-270	-150	-30	μA	
STBY: Low-Level Input Current	IiL(STBY)	-30	—	-1	μA	

Note 1: Characterized; not 100% tested.

2: Only MCP2542FD and MCP2542WFD have a VIO pin. For the MCP2544FD and MCP2544WFD, VIO is internally connected to VDD.

3: -12V to 12V is ensured by characterization, and tested from -2V to 7V.

MCP2542FD/4FD, MCP2542WFD/4WFD

TABLE 2-1: DC CHARACTERISTICS (CONTINUED)

DC Specifications	Electrical Characteristics: Unless otherwise indicated, Extended (E): TAMB = -40°C to +125°C and High (H): TAMB = -40°C to +150°C; VDD = 4.5V to 5.5V, VIO = 1.7V to 5.5V (Note 2), RL = 60Ω, CL = 100 pF; unless otherwise specified.					
Parameter	Sym.	Min.	Typ.	Max.	Units	Conditions
Receive Data (RXD) Output						
High-Level Output Voltage	VOH	VDD - 0.4	—	—	V	MCP2544FD and MCP2544WFD: IOH = -2 mA; typical -4 mA
		VIO - 0.4	—	—		MCP2542FD and MCP2542WFD: VIO = 2.7V to 5.5V, IOH = -1 mA; VIO = 1.7V to 2.7V, IOH = -0.5 mA, typical -2 mA
Low-Level Output Voltage	VOL	—	—	0.4	V	IOL = 4 mA; typical 8 mA
Thermal Shutdown						
Shutdown Junction Temperature	TJ(SD)	165	175	185	°C	-12V < V(CANH, CANL) < +12V (Note 1)
Shutdown Temperature Hysteresis	TJ(HYST)	15	—	30	°C	-12V < V(CANH, CANL) < +12V (Note 1)

Note 1: Characterized; not 100% tested.

Note 2: Only MCP2542FD and MCP2542WFD have a VIO pin. For the MCP2544FD and MCP2544WFD, VIO is internally connected to VDD.

Note 3: -12V to 12V is ensured by characterization, and tested from -2V to 7V.

MCP2542FD/4FD, MCP2542WFD/4WFD

FIGURE 2-2: PHYSICAL BIT REPRESENTATION AND SIMPLIFIED BIAS IMPLEMENTATION



TABLE 2-2: AC CHARACTERISTICS

AC Characteristics		Electrical Characteristics: Unless otherwise indicated, Extended (E): T _{AMB} = -40°C to +125°C and High (H): T _{AMB} = -40°C to +150°C; V _{DD} = 4.5V to 5.5V, V _{IO} = 1.7V to 5.5V (Note 2), R _L = 60Ω, C _L = 100 pF. Maximum V _{DIFF(D)} (I) = 3V.					
Param. No.	Parameter	Sym.	Min.	Typ.	Max.	Units	Conditions
1	Bit Time	t _{BIT}	0.125	—	69.44	μs	
2	Nominal Bit Rate	NBR	14.4	—	8000	kbps	
3	Delay TXD Low to Bus Dominant	t _{TXD-BUSON}	—	50	85	ns	Note 1
4	Delay TXD High to Bus Recessive	t _{TXD-BUSOFF}	—	40	85	ns	Note 1
5	Delay Bus Dominant to RXD	t _{BUSON-RXD}	—	70	85	ns	Note 1
6	Delay Bus Recessive to RXD	t _{BUSOFF-RXD}	—	110	145	ns	Note 1

Note 1: Characterized, not 100% tested.

2: Not in ISO 11898-2:2015, but needs to be characterized.

MCP2542FD/4FD, MCP2542WFD/4WFD

TABLE 2-2: AC CHARACTERISTICS (CONTINUED)

AC Characteristics		Electrical Characteristics: Unless otherwise indicated, Extended (E): T _{AMB} = -40°C to +125°C and High (H): T _{AMB} = -40°C to +150°C; V _{DD} = 4.5V to 5.5V, V _{IO} = 1.7V to 5.5V (Note 2), R _L = 60Ω, C _L = 100 pF. Maximum V _{DIFF(D)} (I) = 3V.					
Param. No.	Parameter	Sym.	Min.	Typ.	Max.	Units	Conditions
7	Propagation Delay TXD to RXD Worst Case of t _{LOOP(R)} and t _{LOOP(F)} Figure 2-10	t _{TXD - RXD}	—	90	120	ns	R _L = 150Ω, C _L = 200 pF (Note 1)
			—	115	150		
7a	Propagation Delay, Rising Edge	t _{LOOP(R)}	—	90	120	ns	
7b	Propagation Delay, Falling Edge	t _{LOOP(F)}	—	80	120	ns	
8a	Recessive Bit Time on RXD – 1 Mbps, Loop Delay Symmetry (Note 2)	t _{BIT(RXD)} , 1M	900	985	1100	ns	t _{BIT(TXD)} = 1000 ns (Figure 2-10)
			800	960	1255		t _{BIT(TXD)} = 1000 ns (Figure 2-10), R _L = 150Ω, C _L = 200 pF (Note 1)
8b	Recessive Bit Time on RXD – 2 Mbps, Loop Delay Symmetry	t _{BIT(RXD)} , 2M	450	490	550	ns	t _{BIT(TXD)} = 500 ns (Figure 2-10)
			400	460	550		t _{BIT(TXD)} = 500 ns (Figure 2-10), R _L = 150Ω, C _L = 200 pF (Note 1)
8c	Recessive Bit Time on RXD – 5 Mbps, Loop Delay Symmetry	t _{BIT(RXD)} , 5M	160	190	220	ns	t _{BIT(TXD)} = 200 ns (Figure 2-10)
8d	Recessive Bit Time on RXD – 8 Mbps, Loop Delay Symmetry (Note 2)	t _{BIT(RXD)} , 8M	85	100	135	ns	t _{BIT(TXD)} = 120 ns (Figure 2-10) (Note 1)
9	CAN Activity Filter Time (Standby)	t _{FILTER}	0.5	1.7	3.6	μs	V _{DIFF(D)} (I) = 1.2V to 3V
10	Delay Standby to Normal Mode	t _{WAKE}	—	7	30	μs	Negative edge on STBY
11	Permanent Dominant Detect Time	t _{PDT}	0.8	1.9	5	ms	T _{XD} = 0V
12	Permanent Dominant Timer Reset	t _{PDTR}	—	5	—	ns	The shortest recessive pulse on TxD or CAN bus to reset Permanent Dominant Timer
13a	Transmitted Bit Time on Bus – 1 Mbps (Note 2)	t _{BIT(BUS)} , 1M	870	1000	1060	ns	t _{BIT(TXD)} = 1000 ns (Figure 2-10)
			870	1000	1060		t _{BIT(TXD)} = 1000 ns (Figure 2-10), R _L = 150Ω, C _L = 200 pF (Note 1)

Note 1: Characterized, not 100% tested.

2: Not in ISO 11898-2:2015, but needs to be characterized.

MCP2542FD/4FD, MCP2542WFD/4WFD

TABLE 2-2: AC CHARACTERISTICS (CONTINUED)

AC Characteristics		Electrical Characteristics: Unless otherwise indicated, Extended (E): T _{AMB} = -40°C to +125°C and High (H): T _{AMB} = -40°C to +150°C; V _{DD} = 4.5V to 5.5V, V _{IO} = 1.7V to 5.5V (Note 2), R _L = 60Ω, C _L = 100 pF. Maximum V _{DIFF(D)} (I) = 3V.					
Param. No.	Parameter	Sym.	Min.	Typ.	Max.	Units	Conditions
13b	Transmitted Bit Time on Bus – 2 Mbps	t _{BIT} (BUS), 2M	435	515	530	ns	t _{BIT} (TXD) = 500 ns (Figure 2-10)
			435	480	550		t _{BIT} (TXD) = 500 ns (Figure 2-10) R _L = 150Ω, C _L = 200 pF (Note 1)
13c	Transmitted Bit Time on Bus – 5 Mbps	t _{BIT} (BUS), 5M	155	200	210	ns	t _{BIT} (TXD) = 200ns (Figure 2-10) (Note 1)
13d	Transmitted Bit Time on Bus - 8Mbps (Note 2)	t _{BIT} (BUS), 8M	100	125	140	ns	t _{BIT} (TXD) = 120 ns (Figure 2-10) (Note 1)
14a	Receiver Timing Symmetry – 1 Mbps (Note 2)	t _{DIFF} (REC), 1M = t _{BIT} (RXD) - t _{BIT} (BUS)	-65	0	40	ns	t _{BIT} (TXD) = 1000 ns (Figure 2-10)
			-130	0	80		t _{BIT} (TXD) = 1000ns (Figure 2-10), R _L = 150Ω, C _L = 200 pF (Note 1)
14b	Receiver Timing Symmetry – 2 Mbps	t _{DIFF} (REC), 2M	-65	0	40	ns	t _{BIT} (TXD) = 500 ns (Figure 2-10)
			-70	0	40		t _{BIT} (TXD) = 500 ns (Figure 2-10), R _L = 150Ω, C _L = 200 pF (Note 1)
14c	Receiver Timing Symmetry – 5 Mbps	t _{DIFF} (REC), 5M	-45	0	15	ns	t _{BIT} (TXD) = 200 ns (Figure 2-10) (Note 1)
14d	Receiver Timing Symmetry – 8 Mbps (Note 2) t _{DIFF} (REC),8M	t _{DIFF} (REC), 8M	-45	0	10	ns	t _{BIT} (TXD) = 120 ns (Figure 2-10) (Note 1)
15	WUP Time Out	t _{WAKE} (TO)	1	1.9	5	ms	MCP2542WFD/4WFD (Figure 2-11)
16	Delay Bus Dominant/Recessive to RxD (Standby mode)	t _{BUS-RXD} (S)	—	0.5	—	μs	

Note 1: Characterized, not 100% tested.

2: Not in ISO 11898-2:2015, but needs to be characterized.

FIGURE 2-3: TEST LOAD CONDITIONS



MCP2542FD/4FD, MCP2542WFD/4WFD

FIGURE 2-4: TEST CIRCUIT FOR ELECTRICAL CHARACTERISTICS



FIGURE 2-5: TEST CIRCUIT FOR AUTOMOTIVE TRANSIENTS



FIGURE 2-6: HYSTERESIS OF THE RECEIVER



MCP2542FD/4FD, MCP2542WFD/4WFD

2.3 Timing Diagrams and Specifications

FIGURE 2-7: TIMING DIAGRAM FOR AC CHARACTERISTICS



FIGURE 2-8: TIMING DIAGRAM FOR WAKEUP FROM STANDBY



FIGURE 2-9: PERMANENT DOMINANT TIMER RESET DETECT



MCP2542FD/4FD, MCP2542WFD/4WFD

FIGURE 2-10: TIMING DIAGRAM FOR LOOP DELAY SYMMETRY



FIGURE 2-11: TIMING DIAGRAM FOR WAKE-UP PATTERN (WUP)



TABLE 2-1: THERMAL SPECIFICATIONS

Parameter	Sym.	Min.	Typ.	Max.	Units	Test Conditions
Temperature Ranges						
Specified Temperature Range	T _A	-40	—	+125	°C	
		-40	—	+150		
Operating Temperature Range	T _A	-40	—	+150	°C	
Storage Temperature Range	T _A	-65	—	+155	°C	
Package Thermal Resistances						
Thermal Resistance, 8LD DFN (3x3)	θ _{JA}	—	56.7	—	°C/W	
Thermal Resistance, 8LD SOIC	θ _{JA}	—	149.5	—	°C/W	
Thermal Resistance, 8LD TDFN (2x3)	θ _{JA}	—	53	—	°C/W	

MCP2542FD/4FD, MCP2542WFD/4WFD

3.0 TYPICAL PERFORMANCE CURVES

Note: The graphs and tables provided following this note are a statistical summary based on a limited number of samples and are provided for informational purposes only. The performance characteristics listed herein are not tested or guaranteed. In some graphs or tables, the data presented may be outside the specified operating range (e.g., outside specified power supply range) and therefore outside the warranted range.



FIGURE 3-1: Dominant Differential Output vs. RL ($V_{DD} = 4.5V$).



FIGURE 3-2: Dominant Differential Output vs. RL ($V_{DD} = 5.0V$).



FIGURE 3-3: Dominant Differential Output vs. RL ($V_{DD} = 5.5V$).

MCP2542FD/4FD, MCP2542WFD/4WFD

NOTES:

MCP2542FD/4FD, MCP2542WFD/4WFD

4.0 PACKAGING INFORMATION

4.1 Package Marking Information

8-Lead DFN (03x03x0.9 mm)



Part Number	Code
MCP2542FD-E/MF	DAEK
MCP2542FDT-H/MF	DAEK
MCP2542FD-H/MF	DAEK
MCP2542FDT-E/MF	DAEK
MCP2542WFD-E/MF	DAEH
MCP2542WFDT-H/MF	DAEH
MCP2542WFD-H/MF	DAEH
MCP2542WFDT-E/MF	DAEH
MCP2544FD-E/MF	DAEJ
MCP2544FDT-H/MF	DAEJ
MCP2544FD-H/MF	DAEJ
MCP2544FDT-E/MF	DAEJ
MCP2544WFD-E/MF	DAEG
MCP2544WFDT-H/MF	DAEG
MCP2544WFD-H/MF	DAEG
MCP2544WFDT-E/MF	DAEG

Example:

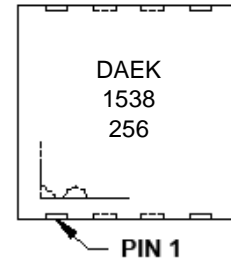

8-Lead SOIC (150 mil)

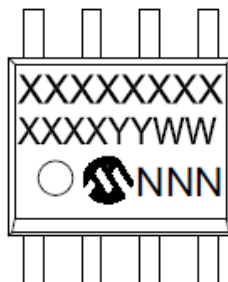

Part Number	Code
MCP2542WFD-E/SN	MCP2542
MCP2542WFDT-H/SN	MCP2542W
MCP2542WFD-H/SN	MCP2542W
MCP2542WFDT-E/SN	MCP2542
MCP2542FD-E/SN	MCP2542W
MCP2542FDT-H/SN	MCP2542W
MCP2542FD-H/SN	MCP2542W
MCP2542FDT-E/SN	MCP2542W
MCP2544WFD-E/SN	MCP2544W
MCP2544WFDT-H/SN	MCP2544WFD
MCP2544WFD-H/SN	MCP2544WFD
MCP2544WFD-E/SN	MCP2544W
MCP2544FD-E/SN	MCP2544
MCP2544FDT-H/SN	MCP2544
MCP2544FD-H/SN	MCP2544
MCP2544FDT-E/SN	MCP2544

Example:

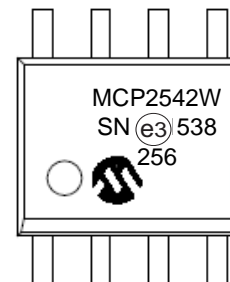

Legend:	XX...X	Customer-specific information
	Y	Year code (last digit of calendar year)
	YY	Year code (last 2 digits of calendar year)
	WW	Week code (week of January 1 is week '01')
	NNN	Alphanumeric traceability code
	e3	Pb-free JEDEC® designator for Matte Tin (Sn)
	e3	This package is Pb-free. The Pb-free JEDEC® designator (e3) can be found on the outer packaging for this package.
Note:	In the event the full Microchip part number cannot be marked on one line, it will be carried over to the next line, thus limiting the number of available characters for customer-specific information.	

MCP2542FD/4FD, MCP2542WFD/4WFD

8-Lead TDFN (02x03x0.8 mm)



Part Number	Code
MCP2542FDT-E/MNY	ACR
MCP2542FDT-H/MNY	ACR
MCP2542WFDT-E/MNY	ACP
MCP2542WFDT-H/MNY	ACP
MCP2544FDT-E/MNY	ACQ
MCP2544FDT-H/MNY	ACQ
MCP2544WFDT-E/MNY	ACN
MCP2544WFDT-H/MNY	ACN

Example:

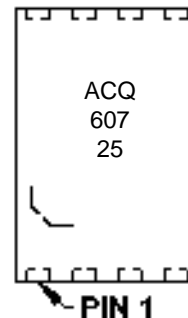

Legend:	XX...X	Customer-specific information
	Y	Year code (last digit of calendar year)
	YY	Year code (last 2 digits of calendar year)
	WW	Week code (week of January 1 is week '01')
	NNN	Alphanumeric traceability code
	*	Pb-free JEDEC® designator for Matte Tin (Sn)
		This package is Pb-free. The Pb-free JEDEC® designator () can be found on the outer packaging for this package.
Note:	In the event the full Microchip part number cannot be marked on one line, it will be carried over to the next line, thus limiting the number of available characters for customer-specific information.	

MCP2542FD/4FD, MCP2542WFD/4WFD

8-Lead Plastic Dual Flat, No Lead Package (MF) - 3x3x0.9mm Body [DFN]

Note: For the most current package drawings, please see the Microchip Packaging Specification located at <http://www.microchip.com/packaging>



Microchip Technology Drawing No. C04-062C Sheet 1 of 2

MCP2542FD/4FD, MCP2542WFD/4WFD

8-Lead Plastic Dual Flat, No Lead Package (MF) - 3x3x0.9mm Body [DFN]

Note: For the most current package drawings, please see the Microchip Packaging Specification located at <http://www.microchip.com/packaging>



Dimension Limits	Units	MILLIMETERS		
		MIN	NOM	MAX
Number of Pins	N	8		
Pitch	e	0.65 BSC		
Overall Height	A	0.80	0.90	1.00
Standoff	A1	0.00	0.02	0.05
Contact Thickness	A3	0.20 REF		
Overall Length	D	3.00 BSC		
Exposed Pad Width	E2	1.34	-	1.60
Overall Width	E	3.00 BSC		
Exposed Pad Length	D2	1.60	-	2.40
Contact Width	b	0.25	0.30	0.35
Contact Length	L	0.20	0.30	0.55
Contact-to-Exposed Pad	K	0.20	-	-

Notes:

1. Pin 1 visual index feature may vary, but must be located within the hatched area.
2. Package may have one or more exposed tie bars at ends.
3. Package is saw singulated
4. Dimensioning and tolerancing per ASME Y14.5M

BSC: Basic Dimension. Theoretically exact value shown without tolerances.

REF: Reference Dimension, usually without tolerance, for information purposes only.

Microchip Technology Drawing No. C04-062C Sheet 2 of 2

MCP2542FD/4FD, MCP2542WFD/4WFD

8-Lead Plastic Dual Flat, No Lead Package (MF) - 3x3x0.9mm Body [DFN]

Note: For the most current package drawings, please see the Microchip Packaging Specification located at <http://www.microchip.com/packaging>

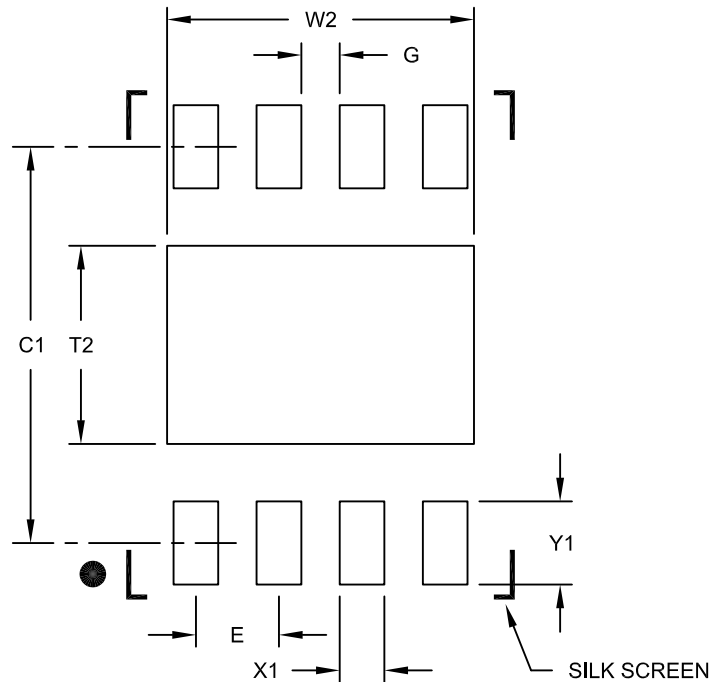

RECOMMENDED LAND PATTERN

Units		MILLIMETERS		
Dimension Limits		MIN	NOM	MAX
Contact Pitch	E	0.65 BSC		
Optional Center Pad Width	W2			2.40
Optional Center Pad Length	T2			1.55
Contact Pad Spacing	C1		3.10	
Contact Pad Width (X8)	X1			0.35
Contact Pad Length (X8)	Y1			0.65
Distance Between Pads	G	0.30		

Notes:

1. Dimensioning and tolerancing per ASME Y14.5M

BSC: Basic Dimension. Theoretically exact value shown without tolerances.

Microchip Technology Drawing No. C04-2062B

MCP2542FD/4FD, MCP2542WFD/4WFD

8-Lead Plastic Small Outline (SN) - Narrow, 3.90 mm Body [SOIC]

Note: For the most current package drawings, please see the Microchip Packaging Specification located at <http://www.microchip.com/packaging>



Microchip Technology Drawing No. C04-057C Sheet 1 of 2

MCP2542FD/4FD, MCP2542WFD/4WFD

8-Lead Plastic Small Outline (SN) - Narrow, 3.90 mm Body [SOIC]

Note: For the most current package drawings, please see the Microchip Packaging Specification located at <http://www.microchip.com/packaging>

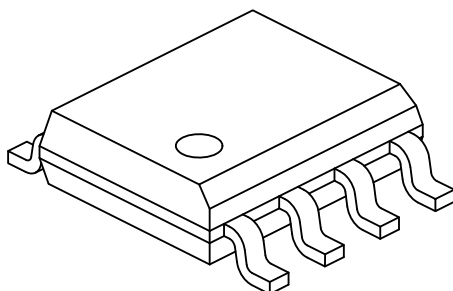

Dimension Limits	Units	MILLIMETERS		
		MIN	NOM	MAX
Number of Pins	N	8		
Pitch	e	1.27 BSC		
Overall Height	A	-	-	1.75
Molded Package Thickness	A2	1.25	-	-
Standoff §	A1	0.10	-	0.25
Overall Width	E	6.00 BSC		
Molded Package Width	E1	3.90 BSC		
Overall Length	D	4.90 BSC		
Chamfer (Optional)	h	0.25	-	0.50
Foot Length	L	0.40	-	1.27
Footprint	L1	1.04 REF		
Foot Angle	φ	0°	-	8°
Lead Thickness	c	0.17	-	0.25
Lead Width	b	0.31	-	0.51
Mold Draft Angle Top	α	5°	-	15°
Mold Draft Angle Bottom	β	5°	-	15°

Notes:

1. Pin 1 visual index feature may vary, but must be located within the hatched area.
2. § Significant Characteristic
3. Dimensions D and E1 do not include mold flash or protrusions. Mold flash or protrusions shall not exceed 0.15mm per side.
4. Dimensioning and tolerancing per ASME Y14.5M
 - BSC: Basic Dimension. Theoretically exact value shown without tolerances.
 - REF: Reference Dimension, usually without tolerance, for information purposes only.

Microchip Technology Drawing No. C04-057C Sheet 2 of 2

MCP2542FD/4FD, MCP2542WFD/4WFD

8-Lead Plastic Small Outline (SN) – Narrow, 3.90 mm Body [SOIC]

Note: For the most current package drawings, please see the Microchip Packaging Specification located at <http://www.microchip.com/packaging>



RECOMMENDED LAND PATTERN

		Units	MILLIMETERS		
Dimension Limits			MIN	NOM	MAX
Contact Pitch	E		1.27 BSC		
Contact Pad Spacing	C			5.40	
Contact Pad Width (X8)	X1				0.60
Contact Pad Length (X8)	Y1				1.55

Notes:

1. Dimensioning and tolerancing per ASME Y14.5M

BSC: Basic Dimension. Theoretically exact value shown without tolerances.

Microchip Technology Drawing No. C04-2057A

MCP2542FD/4FD, MCP2542WFD/4WFD

8-Lead Plastic Dual Flat, No Lead Package (MN) – 2x3x0.75mm Body [TDFN]

Note: For the most current package drawings, please see the Microchip Packaging Specification located at <http://www.microchip.com/packaging>



Microchip Technology Drawing No. C04-129C Sheet 1 of 2

MCP2542FD/4FD, MCP2542WFD/4WFD

8-Lead Plastic Dual Flat, No Lead Package (MN) – 2x3x0.75mm Body [TDFN]

Note: For the most current package drawings, please see the Microchip Packaging Specification located at <http://www.microchip.com/packaging>



Dimension Limits	Units	MILLIMETERS		
		MIN	NOM	MAX
Number of Pins	N	8		
Pitch	e	0.50 BSC		
Overall Height	A	0.70	0.75	0.80
Standoff	A1	0.00	0.02	0.05
Contact Thickness	A3	0.20 REF		
Overall Length	D	2.00 BSC		
Overall Width	E	3.00 BSC		
Exposed Pad Length	D2	1.20	-	1.60
Exposed Pad Width	E2	1.20	-	1.60
Contact Width	b	0.20	0.25	0.30
Contact Length	L	0.25	0.30	0.45
Contact-to-Exposed Pad	K	0.20	-	-

Notes:

1. Pin 1 visual index feature may vary, but must be located within the hatched area.
2. Package may have one or more exposed tie bars at ends.
3. Package is saw singulated
4. Dimensioning and tolerancing per ASME Y14.5M

BSC: Basic Dimension. Theoretically exact value shown without tolerances.

REF: Reference Dimension, usually without tolerance, for information purposes only.

Microchip Technology Drawing No. C04-129C Sheet 2 of 2

MCP2542FD/4FD, MCP2542WFD/4WFD

8-Lead Plastic Dual Flat, No Lead Package (MN) – 2x3x0.75 mm Body [TDFN]

Note: For the most current package drawings, please see the Microchip Packaging Specification located at <http://www.microchip.com/packaging>



Dimension Limits	Units	MILLIMETERS		
		MIN	NOM	MAX
Contact Pitch	E	0.50 BSC		
Optional Center Pad Width	W2			1.46
Optional Center Pad Length	T2			1.36
Contact Pad Spacing	C1		3.00	
Contact Pad Width (X8)	X1			0.30
Contact Pad Length (X8)	Y1			0.75
Distance Between Pads	G	0.20		

Notes:

1. Dimensioning and tolerancing per ASME Y14.5M

BSC: Basic Dimension. Theoretically exact value shown without tolerances.

Microchip Technology Drawing No. C04-2129A

MCP2542FD/4FD, MCP2542WFD/4WFD

NOTES:

MCP2542FD/4FD, MCP2542WFD/4WFD

APPENDIX A: REVISION HISTORY

Revision A (February 2016)

Initial release of this document.

MCP2542FD/4FD, MCP2542WFD/4WFD

PRODUCT IDENTIFICATION SYSTEM

To order or obtain information, e.g., on pricing or delivery, refer to the factory or the listed sales office.

<u>PART NO.</u>	<u>[X]⁽¹⁾</u>	<u>X</u>	<u>[XX]</u>
Device	Tape and Reel Option	Temperature Range	Package
Device:	MCP2542FD/4FD:	CAN FD Transceiver with WUP Option	
	MCP2542WFD/4WFD:	CAN FD Transceiver with WUP Option	
Tape and Reel Option:	Blank = Standard packaging (tube or tray)		
	T = Tape and Reel ⁽¹⁾		
Temperature Range:	E = -40°C to +125°C (Extended)		
	H = -40°C to +150°C (High)		
Package:	MF = Plastic Dual Flat No Lead Package - 3x3x0.9 mm Body (DFN), 8-lead		
	MNY = Plastic Dual Flat No Lead Package - 2x3x0.75 mm Body (TDFN), 8-lead		
	SN = Plastic Small Outline (SN) - Narrow, 3.90 mm, Body (SOIC), 8-lead		

<p>Examples:</p> <p>a) MCP2542FD-E/MF: Extended Temperature, 8-lead, Plastic Dual Flat No Lead DFN package.</p> <p>b) MCP2544WFD-H/MF: High Temperature, 8-lead, Plastic Dual Flat No Lead DFN package.</p> <p>c) MCP2542WFDT-H/SN: Tape and Reel, High Temperature, 8-lead, Plastic Small Outline SOIC package.</p> <p>d) MCP2544WFDT-E/SN: Tape and Reel, Extended Temperature, 8-lead, Plastic Small Outline SOIC package.</p> <p>e) MCP2542FDT-E/MNY: Tape and Reel, Extended Temperature, 8-lead, Plastic Dual Flat No Lead TDFN package.</p> <p>f) MCP2544WFDT-H/MNY: Tape and Reel, High Temperature, 8-lead, Plastic Dual Flat No Lead TDFN package.</p> <p>Note1: Tape and Reel identifier only appears in the catalog part number description. This identifier is used for ordering purposes and is not printed on the device package. Check with your Microchip Sales Office for package availability with the Tape and Reel option.</p>

Note the following details of the code protection feature on Microchip devices:

- Microchip products meet the specification contained in their particular Microchip Data Sheet.
- Microchip believes that its family of products is one of the most secure families of its kind on the market today, when used in the intended manner and under normal conditions.
- There are dishonest and possibly illegal methods used to breach the code protection feature. All of these methods, to our knowledge, require using the Microchip products in a manner outside the operating specifications contained in Microchip's Data Sheets. Most likely, the person doing so is engaged in theft of intellectual property.
- Microchip is willing to work with the customer who is concerned about the integrity of their code.
- Neither Microchip nor any other semiconductor manufacturer can guarantee the security of their code. Code protection does not mean that we are guaranteeing the product as “unbreakable.”

Code protection is constantly evolving. We at Microchip are committed to continuously improving the code protection features of our products. Attempts to break Microchip's code protection feature may be a violation of the Digital Millennium Copyright Act. If such acts allow unauthorized access to your software or other copyrighted work, you may have a right to sue for relief under that Act.

Information contained in this publication regarding device applications and the like is provided only for your convenience and may be superseded by updates. It is your responsibility to ensure that your application meets with your specifications. MICROCHIP MAKES NO REPRESENTATIONS OR WARRANTIES OF ANY KIND WHETHER EXPRESS OR IMPLIED, WRITTEN OR ORAL, STATUTORY OR OTHERWISE, RELATED TO THE INFORMATION, INCLUDING BUT NOT LIMITED TO ITS CONDITION, QUALITY, PERFORMANCE, MERCHANTABILITY OR FITNESS FOR PURPOSE. Microchip disclaims all liability arising from this information and its use. Use of Microchip devices in life support and/or safety applications is entirely at the buyer's risk, and the buyer agrees to defend, indemnify and hold harmless Microchip from any and all damages, claims, suits, or expenses resulting from such use. No licenses are conveyed, implicitly or otherwise, under any Microchip intellectual property rights unless otherwise stated.

Microchip received ISO/TS-16949:2009 certification for its worldwide headquarters, design and wafer fabrication facilities in Chandler and Tempe, Arizona; Gresham, Oregon and design centers in California and India. The Company's quality system processes and procedures are for its PIC® MCUs and dsPIC® DSCs, KEELoC® code hopping devices, Serial EEPROMs, microperipherals, nonvolatile memory and analog products. In addition, Microchip's quality system for the design and manufacture of development systems is ISO 9001:2000 certified.

**QUALITY MANAGEMENT SYSTEM
CERTIFIED BY DNV
= ISO/TS 16949 =**

Trademarks

The Microchip name and logo, the Microchip logo, AnyRate, dsPIC, FlashFlex, flexPWR, Heldo, JukeBlox, KeeLoq, KeeLoq logo, Klear, LANCheck, LINK MD, MediaLB, MOST, MOST logo, MPLAB, OptoLyzer, PIC, PICSTART, PIC32 logo, RightTouch, SpyNIC, SST, SST Logo, SuperFlash and UNI/O are registered trademarks of Microchip Technology Incorporated in the U.S.A. and other countries.

ClockWorks, The Embedded Control Solutions Company, ETHERSYNCH, Hyper Speed Control, HyperLight Load, IntelliMOS, mTouch, Precision Edge, and QUIET-WIRE are registered trademarks of Microchip Technology Incorporated in the U.S.A.

Analog-for-the-Digital Age, Any Capacitor, AnyIn, AnyOut, BodyCom, chipKIT, chipKIT logo, CodeGuard, dsPICDEM, dsPICDEM.net, Dynamic Average Matching, DAM, ECAN, EtherGREEN, In-Circuit Serial Programming, ICSP, Inter-Chip Connectivity, JitterBlocker, KlearNet, KlearNet logo, MiWi, motorBench, MPASM, MPF, MPLAB Certified logo, MPLIB, MPLINK, MultiTRAK, NetDetach, Omniscient Code Generation, PICDEM, PICDEM.net, PICkit, PICtail, PureSilicon, RightTouch logo, REAL ICE, Ripple Blocker, Serial Quad I/O, SQL, SuperSwitcher, SuperSwitcher II, Total Endurance, TSHARC, USBCheck, VariSense, ViewSpan, WiperLock, Wireless DNA, and ZENA are trademarks of Microchip Technology Incorporated in the U.S.A. and other countries.

SQTP is a service mark of Microchip Technology Incorporated in the U.S.A.

Silicon Storage Technology is a registered trademark of Microchip Technology Inc. in other countries.

GestIC is a registered trademarks of Microchip Technology Germany II GmbH & Co. KG, a subsidiary of Microchip Technology Inc., in other countries.

All other trademarks mentioned herein are property of their respective companies.

© 2016, Microchip Technology Incorporated, Printed in the U.S.A., All Rights Reserved.

ISBN: 978-1-5224-0347-0



MICROCHIP

Worldwide Sales and Service

AMERICAS

Corporate Office
2355 West Chandler Blvd.
Chandler, AZ 85224-6199
Tel: 480-792-7200
Fax: 480-792-7277
Technical Support:
<http://www.microchip.com/support>
Web Address:
www.microchip.com

Atlanta
Duluth, GA
Tel: 678-957-9614
Fax: 678-957-1455

Austin, TX
Tel: 512-257-3370

Boston
Westborough, MA
Tel: 774-760-0087
Fax: 774-760-0088

Chicago
Itasca, IL
Tel: 630-285-0071
Fax: 630-285-0075

Cleveland
Independence, OH
Tel: 216-447-0464
Fax: 216-447-0643

Dallas
Addison, TX
Tel: 972-818-7423
Fax: 972-818-2924

Detroit
Novi, MI
Tel: 248-848-4000

Houston, TX
Tel: 281-894-5983

Indianapolis
Noblesville, IN
Tel: 317-773-8323
Fax: 317-773-5453

Los Angeles
Mission Viejo, CA
Tel: 949-462-9523
Fax: 949-462-9608

New York, NY
Tel: 631-435-6000

San Jose, CA
Tel: 408-735-9110

Canada - Toronto
Tel: 905-673-0699
Fax: 905-673-6509

ASIA/PACIFIC

Asia Pacific Office
Suites 3707-14, 37th Floor
Tower 6, The Gateway
Harbour City, Kowloon

Hong Kong
Tel: 852-2943-5100
Fax: 852-2401-3431

Australia - Sydney
Tel: 61-2-9868-6733
Fax: 61-2-9868-6755

China - Beijing
Tel: 86-10-8569-7000
Fax: 86-10-8528-2104

China - Chengdu
Tel: 86-28-8665-5511
Fax: 86-28-8665-7889

China - Chongqing
Tel: 86-23-8980-9588
Fax: 86-23-8980-9500

China - Dongguan
Tel: 86-769-8702-9880

China - Hangzhou
Tel: 86-571-8792-8115
Fax: 86-571-8792-8116

China - Hong Kong SAR
Tel: 852-2943-5100
Fax: 852-2401-3431

China - Nanjing
Tel: 86-25-8473-2460
Fax: 86-25-8473-2470

China - Qingdao
Tel: 86-532-8502-7355
Fax: 86-532-8502-7205

China - Shanghai
Tel: 86-21-5407-5533
Fax: 86-21-5407-5066

China - Shenyang
Tel: 86-24-2334-2829
Fax: 86-24-2334-2393

China - Shenzhen
Tel: 86-755-8864-2200
Fax: 86-755-8203-1760

China - Wuhan
Tel: 86-27-5980-5300
Fax: 86-27-5980-5118

China - Xian
Tel: 86-29-8833-7252
Fax: 86-29-8833-7256

ASIA/PACIFIC

China - Xiamen
Tel: 86-592-2388138
Fax: 86-592-2388130

China - Zhuhai
Tel: 86-756-3210040
Fax: 86-756-3210049

India - Bangalore
Tel: 91-80-3090-4444
Fax: 91-80-3090-4123

India - New Delhi
Tel: 91-11-4160-8631
Fax: 91-11-4160-8632

India - Pune
Tel: 91-20-3019-1500

Japan - Osaka
Tel: 81-6-6152-7160
Fax: 81-6-6152-9310

Japan - Tokyo
Tel: 81-3-6880-3770
Fax: 81-3-6880-3771

Korea - Daegu
Tel: 82-53-744-4301
Fax: 82-53-744-4302

Korea - Seoul
Tel: 82-2-554-7200
Fax: 82-2-558-5932 or
82-2-558-5934

Malaysia - Kuala Lumpur
Tel: 60-3-6201-9857
Fax: 60-3-6201-9859

Malaysia - Penang
Tel: 60-4-227-8870
Fax: 60-4-227-4068

Philippines - Manila
Tel: 63-2-634-9065
Fax: 63-2-634-9069

Singapore
Tel: 65-6334-8870
Fax: 65-6334-8850

Taiwan - Hsin Chu
Tel: 886-3-5778-366
Fax: 886-3-5770-955

Taiwan - Kaohsiung
Tel: 886-7-213-7828

Taiwan - Taipei
Tel: 886-2-2508-8600
Fax: 886-2-2508-0102

Thailand - Bangkok
Tel: 66-2-694-1351
Fax: 66-2-694-1350

EUROPE

Austria - Wels
Tel: 43-7242-2244-39
Fax: 43-7242-2244-393

Denmark - Copenhagen
Tel: 45-4450-2828
Fax: 45-4485-2829

France - Paris
Tel: 33-1-69-53-63-20
Fax: 33-1-69-30-90-79

Germany - Dusseldorf
Tel: 49-2129-3766400

Germany - Karlsruhe
Tel: 49-721-625370

Germany - Munich
Tel: 49-89-627-144-0
Fax: 49-89-627-144-44

Italy - Milan
Tel: 39-0331-742611
Fax: 39-0331-466781

Italy - Venice
Tel: 39-049-7625286

Netherlands - Drunen
Tel: 31-416-690399
Fax: 31-416-690340

Poland - Warsaw
Tel: 48-22-3325737

Spain - Madrid
Tel: 34-91-708-08-90
Fax: 34-91-708-08-91

Sweden - Stockholm
Tel: 46-8-5090-4654

UK - Wokingham
Tel: 44-118-921-5800
Fax: 44-118-921-5820

07/14/15

Mouser Electronics

Authorized Distributor

Click to View Pricing, Inventory, Delivery & Lifecycle Information:

Microchip:

[MCP2542WFD-H/SN](#) [MCP2544WFDT-H/MF](#) [MCP2542WFDT-H/SN](#) [MCP2542WFDT-E/SN](#) [MCP2544WFD-H/SN](#)
[MCP2542FDT-E/MF](#) [MCP2544FDT-H/MNY](#) [MCP2544WFDT-E/SN](#) [MCP2542WFD-E/SN](#) [MCP2544FDT-E/MF](#)
[MCP2544WFDT-H/SN](#) [MCP2542WFDT-H/MNY](#) [MCP2544FD-H/SN](#) [MCP2544WFDT-H/MNY](#) [MCP2542FD-H/SN](#)
[MCP2542FDT-E/SN](#) [MCP2544WFD-E/SN](#) [MCP2542FDT-H/MNY](#) [MCP2544FD-E/SN](#) [MCP2542FDT-H/SN](#)
[MCP2542WFDT-H/MF](#) [MCP2544FDT-E/SN](#) [MCP2542FDT-E/MNY](#) [MCP2544FDT-H/SN](#) [MCP2544WFDT-E/MF](#)
[MCP2544FDT-E/MNY](#) [MCP2542FDT-H/MF](#) [MCP2542WFDT-E/MNY](#) [MCP2544FDT-H/MF](#) [MCP2544WFDT-E/MNY](#)
[MCP2542FD-E/SN](#) [MCP2542WFDT-E/MF](#) [MCP2542FD-E/MF](#)

Компания «Life Electronics» занимается поставками электронных компонентов импортного и отечественного производства от производителей и со складов крупных дистрибьюторов Европы, Америки и Азии.

С конца 2013 года компания активно расширяет линейку поставок компонентов по направлению коаксиальный кабель, кварцевые генераторы и конденсаторы (керамические, пленочные, электролитические), за счёт заключения дистрибьюторских договоров

Мы предлагаем:

- Конкуренспособные цены и скидки постоянным клиентам.
- Специальные условия для постоянных клиентов.
- Подбор аналогов.
- Поставку компонентов в любых объемах, удовлетворяющих вашим потребностям.
- Приемлемые сроки поставки, возможна ускоренная поставка.
- Доставку товара в любую точку России и стран СНГ.
- Комплексную поставку.
- Работу по проектам и поставку образцов.
- Формирование склада под заказчика.
- Сертификаты соответствия на поставляемую продукцию (по желанию клиента).
- Тестирование поставляемой продукции.
- Поставку компонентов, требующих военную и космическую приемку.
- Входной контроль качества.
- Наличие сертификата ISO.

В составе нашей компании организован Конструкторский отдел, призванный помогать разработчикам, и инженерам.

Конструкторский отдел помогает осуществить:

- Регистрацию проекта у производителя компонентов.
- Техническую поддержку проекта.
- Защиту от снятия компонента с производства.
- Оценку стоимости проекта по компонентам.
- Изготовление тестовой платы монтаж и пусконаладочные работы.



Тел: +7 (812) 336 43 04 (многоканальный)
Email: org@lifeelectronics.ru