

## Applications

- For Band 40 TD-LTE applications

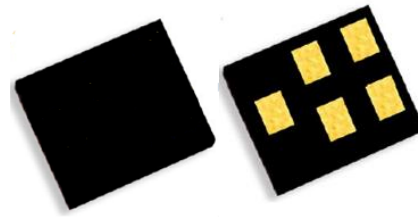

1.1 x 0.9 x 0.50 mm

## Product Features

- Highly selective BAW filter achieving low insertion loss over full bandwidth and operating conditions
- Excellent WiFi Rejection
- Performance -20 to +90 °C
- RoHS Compliant, Pb-free Module Package

## Functional Block Diagram

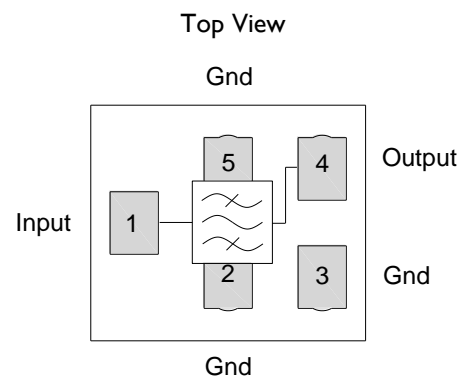

## General Description

The 885075 is a high-performance, high power Bulk Acoustic Wave (BAW) Tx/Rx filter designed to meet the strict LTE rejection requirements for use in B40.

The 885075 is specifically designed to meet the high performance expectations of insertion loss and rejection for LTE transmit systems under all operating conditions.

The 885075 uses common module packaging techniques to achieve the industry standard 1.1 x 0.9 x 0.50 mm footprint. The filter exhibits excellent power handling capabilities.

## Pin Configuration

Pin No.	Label
1	B40 Tx Input / Rx Output
4	B40 Ant
2,3,5	Ground

## Ordering Information

Part No.	Description
885075	Packaged part
885075-EVB	Evaluation board
Standard T/R size = 15,000 units/reel	

## Absolute Maximum Ratings

Parameter	Rating
Operable Temperature	-20 to +90 °C
Storage Temperature	-40 to +90 °C
RF Input Power (pin 1) CW, +55 °C for 5K hours	+29 dBm
Peak RF Input Power (pin 1), max duration of 0.5 sec.	+37 dBm

Notes:

1. Operation of this device outside the parameter ranges given may cause permanent damage.

## Electrical Specifications <sup>(1)</sup>

Parameter	Conditions	Min	Typ	Max	Unit
Insertion Loss	2300 – 2395 MHz	-	1.2 <sup>(2)</sup>	2.6	dB
	2300 – 2395 MHz Integrated over 5 MHz		2.2		dB
	2395 – 2400 MHz	-	2.0 <sup>(2)</sup>	3.0	dB
VSWR (ANT)	2300 – 2400 MHz	-	1.4:1	2.0:1	
VSWR (TX)	2300 – 2400 MHz	-	1.4:1	1.8:1	
Passband Ripple	2300 – 2400 MHz	-	1.1	1.7	dB
Attenuation	10 – 1574 MHz	31	34	-	dB
	703 – 748 MHz	40			
	1574 – 1577 MHz	31	36	-	dB
	1577 – 1680 MHz	31	30	-	dB
	1710 – 1785 MHz	29			
	1805 – 2170 MHz	25			
	1845 – 1880 MHz	27	29.5	-	dB
	2110 – 2170 MHz	25	26	-	dB
	2427 – 2460 MHz	45			
	2460 – 2500 MHz	36	46	-	dB
	4600 – 4800 MHz	30	34	-	dB
	6900 – 7200 MHz	30	39	-	dB
	WiFi Channels 5 <sup>(3)</sup>	34	46	-	dB
	WiFi Channels 6 – 13 <sup>(3)</sup>	40	51	-	dB
2422 – 7200 MHz <sup>(3)</sup>	20		-	dB	
H2	2300 – 2400 MHz <sup>(4)</sup>		-35		dBm

Notes:

1. All specifications are based on the TriQuint schematic for the main reference design shown on page 3. Min/max is being specified over -20 to +90 °C.
2. Typical values are derived through integration of the linear s-parameter over the indicated band at +25 °C.
3. Integration of linear s-parameters over an 18MHz sliding frequency span.
4. H2 is measured for Pin=28 dBm (CW) at room temperature.

**885025-EVB Evaluation Board**

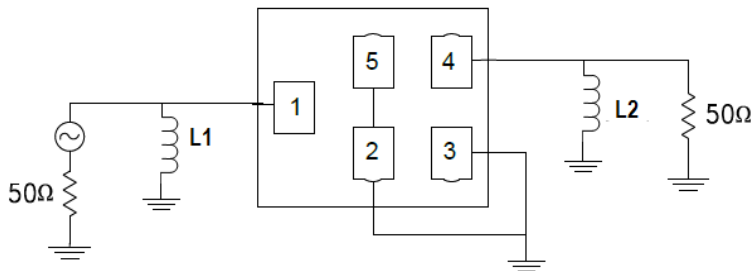
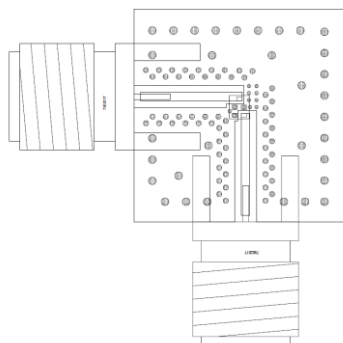

**Notes:**

1. Matching component values shown are for the specified TriQuint evaluation board. Value adjustment may be required in end user product circuits depending on component manufacturer and PCB material.

**Bill of Material – 885025-EVB**

Reference Des.	Value	Description	Manuf.	Part Number
PCB	N/A	3 layer	Multiple	
U1	N/A	2300-2400 MHz Tx/Rx Filter	TriQuint	885075
L1	3.4 nH	Chip Inductor, 0201, ±2%	Murata	
L2	3.4 nH	Chip Inductor, 0201, ±2%	Murata	
SMA	N/A	SMA connector	Radiall USA Inc.	9602-1111-018

**Performance Plots**

Test conditions unless otherwise noted: Temp. = +25 °C

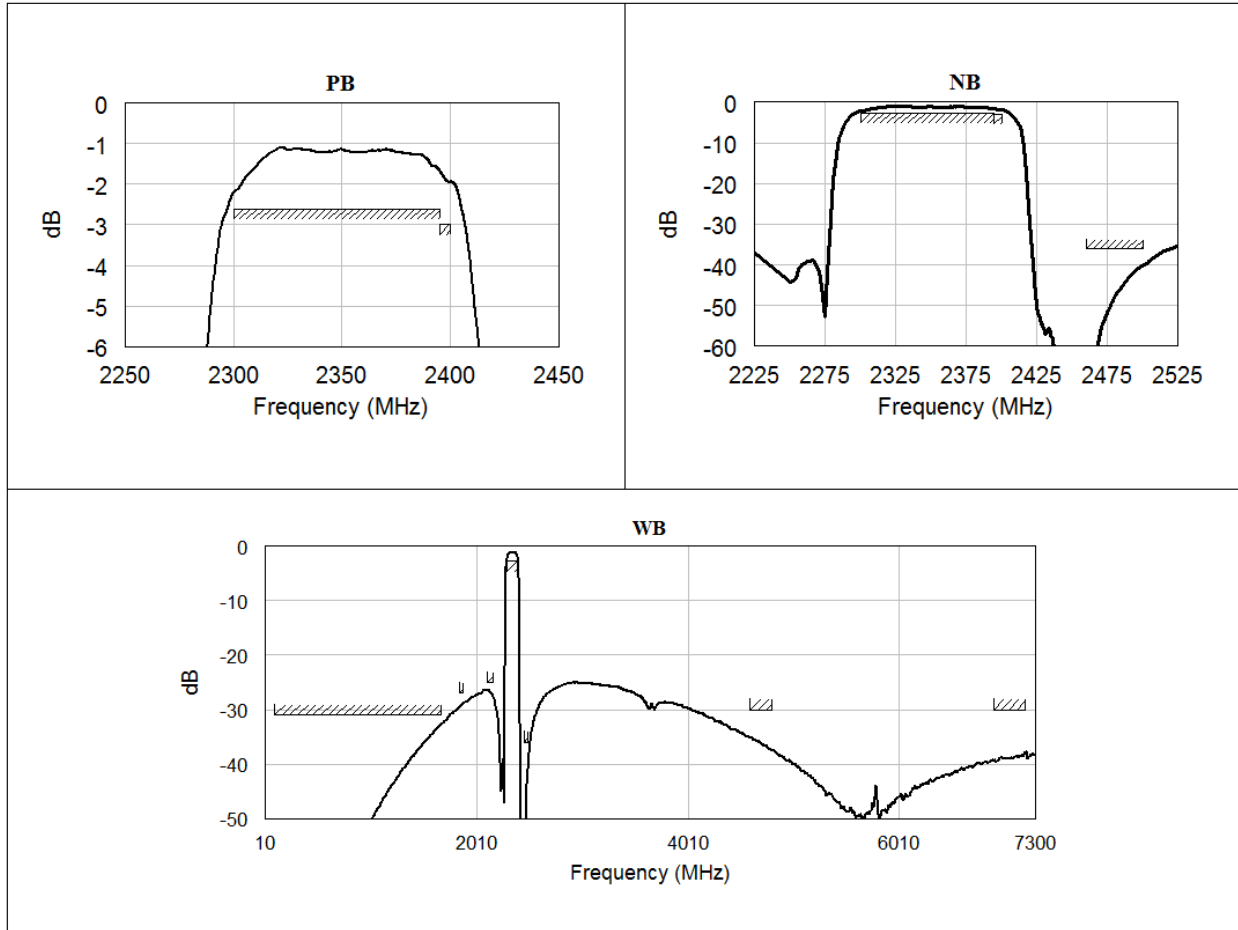

**Performance Plots (cont'd)**

Test conditions unless otherwise noted: Temp. = +25 °C

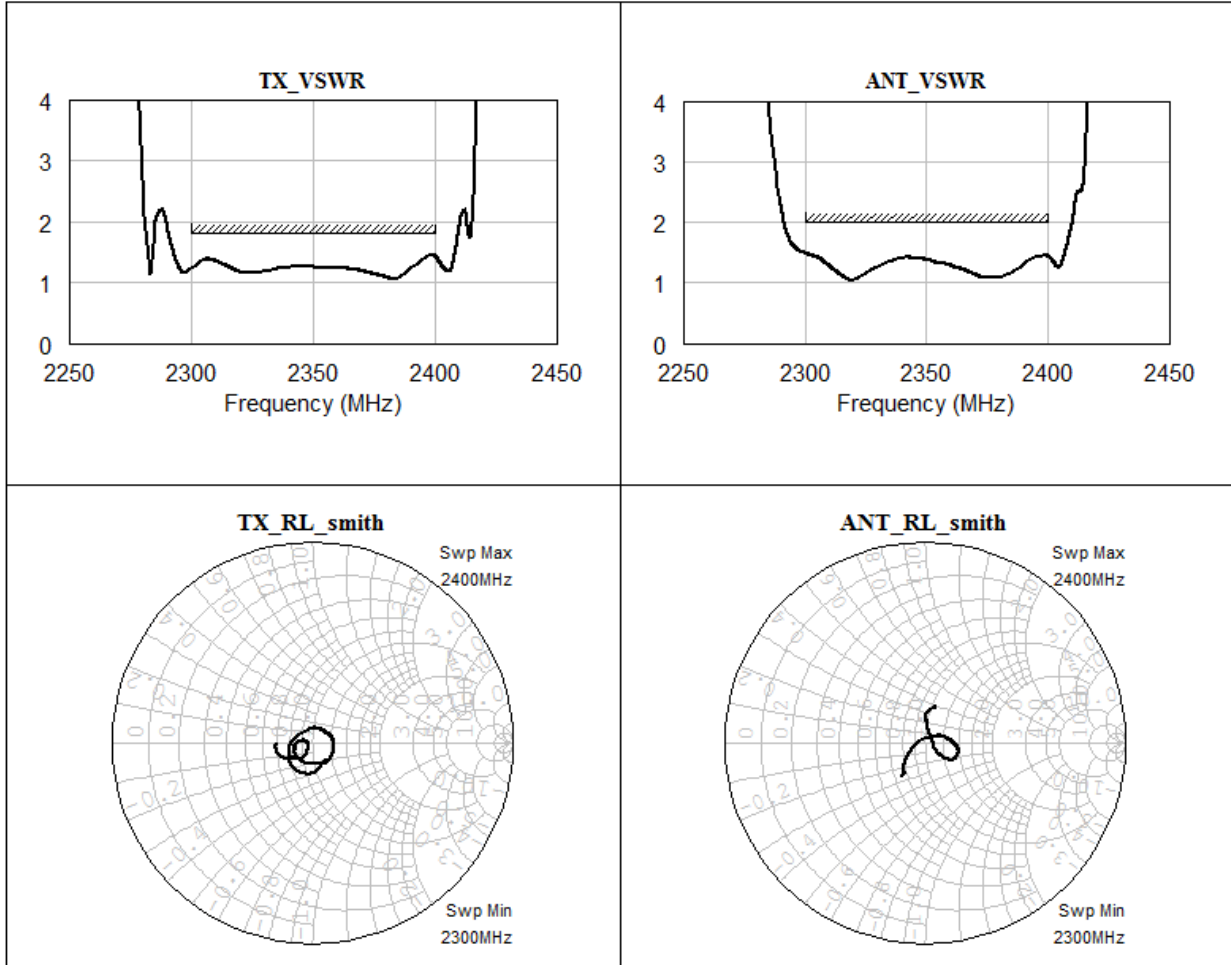

**Package Information, Marking and Dimensions**

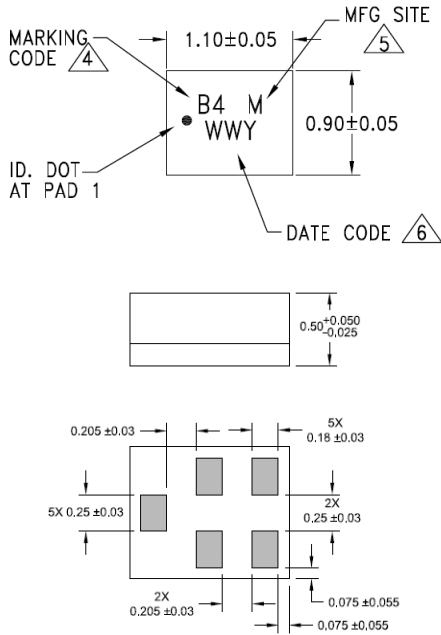

Package Style: CSP  
Dimensions: 1.1 x 0.9 x 0.50 mm

Package for Surface Mount Technology  
Terminations: Au plating 0.5 - 1.0µm, over a 2- 6µm Ni Plating  
Approximate weight 1.37mg.

Marking Code uniquely identifies Part Number  
M = Manufacturing site (Blank for Apopka, C for Costa Rica)  
Date code consists of:  
WW = 2 digit week,  
Y = last digit of year

An asterisk (\*) in front of the marking code indicates prototype.

**PCB Mounting Pattern**

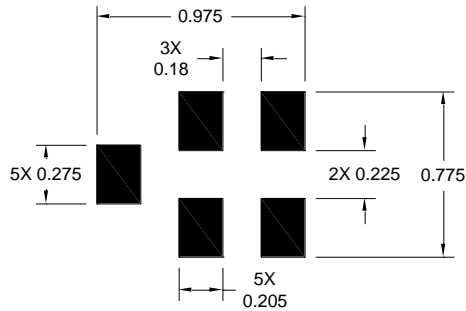

**Notes:**

1. All dimensions are in millimeters. Angles are in degrees.
2. This drawing specifies the mounting pattern used on the TriQuint evaluation board for this product. Some modification may be necessary to suit end user assembly materials and processes.

**Tape and Reel information**

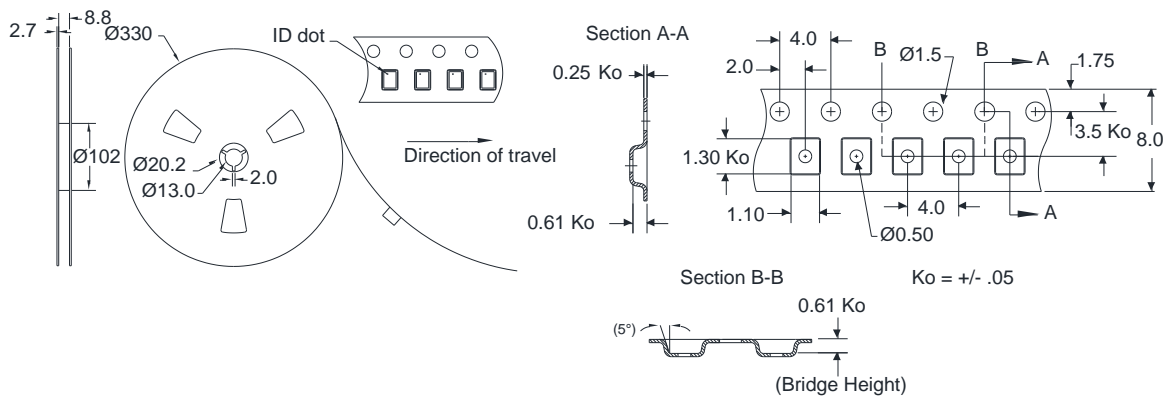

Standard T/R size=15,000 units/reel. All dimensions are in millimeters.

## Product Compliance Information

### ESD Sensitivity Ratings



Caution! ESD-Sensitive Device

ESD Rating: Class 1C  
Value:  $\geq 1000$  V to  $< 2000$  V  
Test: Human Body Model (HBM)  
Standard: JEDEC/ESDA Standard JS-001-2012

ESD Rating: Class C3  
Value:  $\geq 1000$  V  
Test: Charged Device Model (CDM)  
Standard: JEDEC Standard JESD22-C101F

### MSL Rating

MSL Rating: Level 3  
Test: 260°C convection reflow  
Standard: JEDEC Standard IPC/JEDEC J-STD-020

### Solderability

Compatible with the latest version of J-STD-020, lead free solder, 260°C

Refer to [Soldering Profile](#) for recommended guidelines.

### RoHS Compliance

This part is compliant with EU 2002/95/EC RoHS directive (Restrictions on the Use of Certain Hazardous Substances in Electrical and Electronic Equipment).

This product also has the following attributes:

- Halogen Free (Chlorine, Bromine)
- Antimony Free
- TBBP-A (C<sub>15</sub>H<sub>12</sub>Br<sub>4</sub>O<sub>2</sub>) Free
- PFOS Free
- SVHC Free

## Contact Information

For the latest specifications, additional product information, worldwide sales and distribution locations, and information about TriQuint:

Web: [www.triquint.com](http://www.triquint.com)  
Email: [info-sales@triquint.com](mailto:info-sales@triquint.com)

Tel: +1.407.886.8860  
Fax: +1.407.886.7061

## Important Notice

The information contained herein is believed to be reliable. TriQuint makes no warranties regarding the information contained herein. TriQuint assumes no responsibility or liability whatsoever for any of the information contained herein. TriQuint assumes no responsibility or liability whatsoever for the use of the information contained herein. The information contained herein is provided "AS IS, WHERE IS" and with all faults, and the entire risk associated with such information is entirely with the user. All information contained herein is subject to change without notice. Customers should obtain and verify the latest relevant information before placing orders for TriQuint products. The information contained herein or any use of such information does not grant, explicitly or implicitly, to any party any patent rights, licenses, or any other intellectual property rights, whether with regard to such information itself or anything described by such information.

TriQuint products are not warranted or authorized for use as critical components in medical, life-saving, or life-sustaining applications, or other applications where a failure would reasonably be expected to cause severe personal injury or death.

Компания «Life Electronics» занимается поставками электронных компонентов импортного и отечественного производства от производителей и со складов крупных дистрибьюторов Европы, Америки и Азии.

С конца 2013 года компания активно расширяет линейку поставок компонентов по направлению коаксиальный кабель, кварцевые генераторы и конденсаторы (керамические, пленочные, электролитические), за счёт заключения дистрибьюторских договоров

Мы предлагаем:

- Конкурентоспособные цены и скидки постоянным клиентам.
- Специальные условия для постоянных клиентов.
- Подбор аналогов.
- Поставку компонентов в любых объемах, удовлетворяющих вашим потребностям.
- Приемлемые сроки поставки, возможна ускоренная поставка.
- Доставку товара в любую точку России и стран СНГ.
- Комплексную поставку.
- Работу по проектам и поставку образцов.
- Формирование склада под заказчика.
- Сертификаты соответствия на поставляемую продукцию (по желанию клиента).
- Тестирование поставляемой продукции.
- Поставку компонентов, требующих военную и космическую приемку.
- Входной контроль качества.
- Наличие сертификата ISO.

В составе нашей компании организован Конструкторский отдел, призванный помогать разработчикам, и инженерам.

Конструкторский отдел помогает осуществить:

- Регистрацию проекта у производителя компонентов.
- Техническую поддержку проекта.
- Защиту от снятия компонента с производства.
- Оценку стоимости проекта по компонентам.
- Изготовление тестовой платы монтаж и пусконаладочные работы.



Тел: +7 (812) 336 43 04 (многоканальный)

Email: [org@lifeelectronics.ru](mailto:org@lifeelectronics.ru)