

HLMP-Cx08 Series, HLMP-Cx25 Series HLMP-Cx27 Series, HLMP-C610 T-1³/₄ (5 mm) AlInGaP Lamps



Data Sheet



Description

The HLMP-Cx08, HLMP-Cx25, HLMP-Cx27, and HLMP-C610 series are 5 mm lamps specially designed for applications requiring very high on-axis intensity that is not achievable with a standard lamp. These devices are capable of producing light output over a wide range of drive currents.

Built using AlInGaP technology, they are well suited for typical 5 mm TS-AlGaAs lamp applications, and have significantly SUPERIOR RELIABILITY than most TS-AlGaAs lamps in wet/hot environments. These lamps come with clear non-diffused lens and are optically designed to yield superior light output.

Features

- High intensity
- General purpose leads
- Popular 5 mm diameter
- Available in bulk, tape and reel, or ammopack
- 8° or 25° viewing angles
- Choice of colors: Amber or Red

Applications

- Indoor/outdoor applications
- Small store-front signs
- Message panels
- Road construction barrier lights
- Center high mount stop lights
- Spoiler, car decorative lighting
- Motorcycle/bicycle warning lights

Device Selection

Part Number	Standoff	Typical Viewing Angle ^[1] (degrees), 2 $\theta_{1/2}$	Luminous Intensity, I _v (mcd) @ 20 mA		Color	Dominant Wavelength ^[2]
			Min.	Typ.		
HLMP-C008-U00xx	No	8	2900	6000	Red	626
HLMP-C208-S00xx		8	2600	3000	Amber	590
HLMP-C608-R00xx		8	1000	2000	Red	635
HLMP-C610-R00xx	Yes	8	1000	2000	Red	635
HLMP-C025-P00xx	No	25	500	1000	Red	626
HLMP-C225-O00xx		25	450	800	Amber	590
HLMP-C625-P00xx		25	500	700	Red	635
HLMP-C027-P00xx	Yes	25	500	1000	Red	626
HLMP-C627-P00xx		25	500	700	Red	635
HLMP-C325-P00xx	No	25	500		Orange	605

Notes:

1. $\theta_{1/2}$ is the off-axis angle at which the luminous intensity is half of the axial luminous intensity.

2. The dominant wavelength, λ_d , is derived from the CIE chromaticity diagram and represents the single wavelength which defines the color of the device.

Package Dimensions

HLMP-Cx27



HLMP-Cx25



HLMP-C610

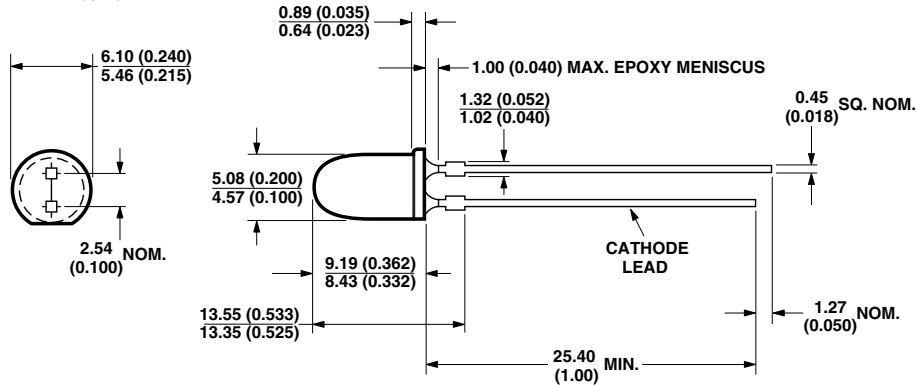

HLMP-Cx08



Part Numbering System

HLMP - C x xx - x x x xx



Absolute Maximum Ratings at $T_A = 25^\circ\text{C}$

Parameter	Absolute Maximum	Units
Peak Forward Current	70	mA
Average Forward Current ^[1]	30	mA
DC Current ^[2]	50	mA
Reverse Voltage ($I_R = 100 \mu\text{A}$)	5	V
LED Junction Temperature	110	$^\circ\text{C}$
Operating Temperature Range	-40 to +100	$^\circ\text{C}$
Storage Temperature Range	-40 to +100	$^\circ\text{C}$

Notes:

- See Figure 2 to establish pulsed operating conditions.
- Derate linearly from 50°C at $0.5 \text{ mA}/^\circ\text{C}$.
- The transient peak current is the maximum non-recurring peak current that can be applied to the device without damaging the LED die and wirebond. It is not recommended that this device be operated at peak currents above the Absolute Maximum Peak Forward Current.

Optical/Electrical Characteristics at $T_A=25^\circ\text{C}$

Symbol	Parameter	Device	Min.	Typ. ^[3]	Max.	Units	Test Conditions
$2\theta^{1/2}$	Included Angle Between Half Luminous Intensity Points ^[1]	HLMP-C008		8		Deg.	$I_F = 20\text{ mA}$ See Note 1
		HLMP-C208		8			
		HLMP-C608		8			
		HLMP-C025		25			
		HLMP-C225		25			
		HLMP-C325		25			
		HLMP-C625		25			
		HLMP-C610		8			
		HLMP-C027		25			
λ_d	Dominant Wavelength ^[2]	HLMP-C008		626		nm	See Note 2
		HLMP-C208		590			
		HLMP-C608		635			
		HLMP-C025		626			
		HLMP-C225		590			
		HLMP-C325		605			
		HLMP-C625		635			
		HLMP-C610		635			
		HLMP-C027		626			
λ_{PEAK}	Peak Wavelength	HLMP-C008		635		nm	Measurement at Peak
		HLMP-C208		594			
		HLMP-C608		650			
		HLMP-C025		635			
		HLMP-C225		594			
		HLMP-C325		611			
		HLMP-C625		650			
		HLMP-C610		650			
		HLMP-C027		635			
HLMP-C627		650					
$\Delta\lambda^{1/2}$	Spectral Line Halfwidth		17			nm	
τ_s	Speed of Response		20			ns	
C	Capacitance		40			pF	$V_F = 0; f = 1\text{ MHz}$
$R\theta_{\text{J-PIN}}$	Thermal Resistance		260			$^\circ\text{C/W}$	Junction to Cathode Lead
V_F	Forward Voltage	HLMP-C008		1.9	2.4	V	$I_F = 20\text{ mA}$
		HLMP-C208		1.9	2.6		
		HLMP-C608		1.9	2.2		
		HLMP-C025		1.9	2.4		
		HLMP-C225		1.9	2.6		
		HLMP-C625		1.9	2.2		
		HLMP-C610		1.9	2.2		
		HLMP-C027		1.9	2.4		
		HLMP-C627		1.9	2.2		
V_R	Reverse Breakdown Voltage		5.0			V	$I_R = 100\ \mu\text{A}$

Notes:

- $\theta^{1/2}$ is the off-axis angle at which the luminous intensity is half of the axial luminous intensity.
- The dominant wavelength, λ_d , is derived from the CIE chromaticity diagram and represents the single wavelength which defines the color of the device.
- Typical specification for reference only. Do not exceed absolute maximum ratings.



Figure 1. Relative intensity vs. wavelength.

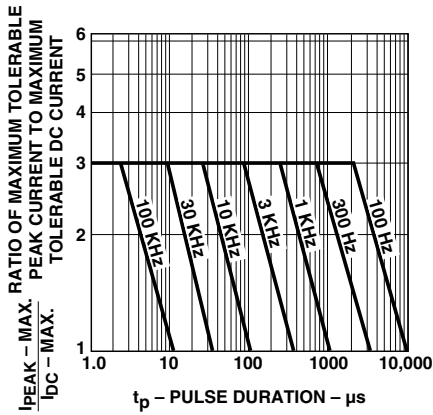

Figure 2. Maximum tolerable peak current vs. pulse duration.

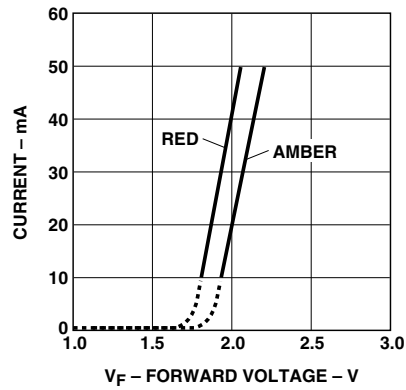

Figure 3. Forward current vs. forward voltage.

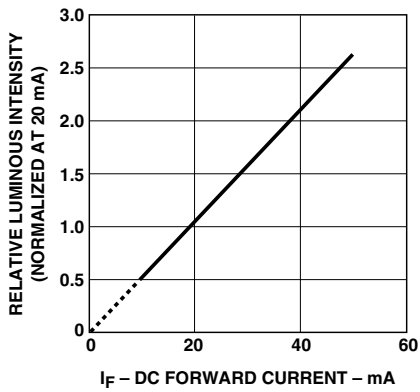

Figure 4. Relative luminous intensity vs. forward current.

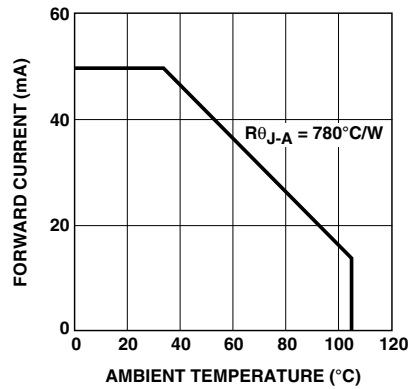

Figure 5. Maximum forward DC current vs. ambient temperature.

Soldering/Cleaning

Cleaning agents from the ketone family (acetone, methyl ethyl ketone, etc.) and from the chlorinated hydrocarbon family (methylene chloride, trichloro-ethylene, carbon tetrachloride, etc.) are not recommended for cleaning LED parts. All of these various solvents attack or dissolve the encapsulating epoxies used to form the package of plastic LED parts.

For information on soldering LEDs, please refer to Application Note 1027.

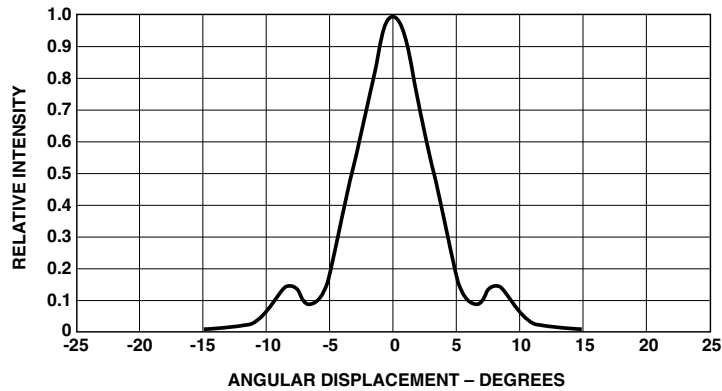

Figure 6. Relative luminous intensity vs. angular displacement for HLMP-Cx08 and HLMP-Cx10.

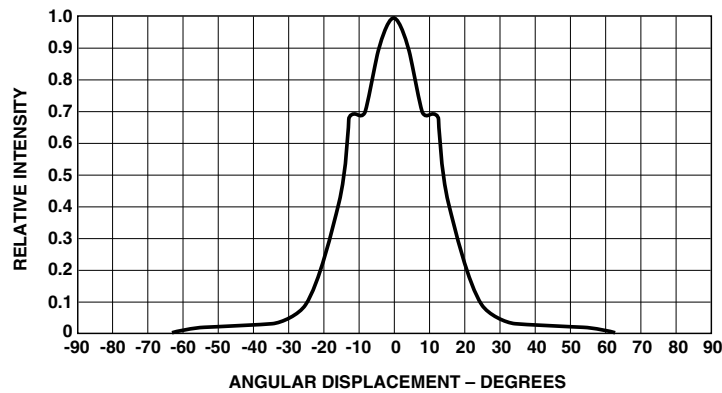

Figure 7. Relative luminous intensity vs. angular displacement for HLMP-Cx25 and HLMP-Cx27.

Intensity Bin Limits

Color	Bin	Intensity Range (mcd)	
		Min.	Max.
Res/Orange	P	540.0	850.0
	Q	850.0	1200.0
	R	1200.0	1700.0
	S	1700.0	2400.0
	T	2400.0	3400.0
	U	3400.0	4900.0
	V	4900.0	7100.0
	W	7100.0	10200.0
	X	10200.0	14800.0
	Y	14800.0	21400.0
	Z	21400.0	30900.0
Yellow	O	510.0	800.0
	P	800.0	1250.0
	Q	1250.0	1800.0
	R	1800.0	2900.0
	S	2900.0	4700.0
	T	4700.0	7200.0
	U	7200.0	11700.0
V	11700.0	18000.0	
W	18000.0	27000.0	

Maximum tolerance for each bin limit is $\pm 18\%$.

Color Categories

Color	Category#	Lambda (nm)	
		Min.	Max.
Orange	2	599	602.5
	3	601.5	605
	4	603.8	608.2
	5	606.8	611.2

Tolerance for each bin limit is ± 0.5 nm.

Mechanical Option Matrix

Mechanical Option Code	Definition
00	Bulk Packaging, minimum increment 500 pcs/bag
02	Tape & Reel, straight leads, minimum increment 1300 pcs/bag
DD	Ammo Pack, straight leads with minimum increment 2K/pack

Note:

All categories are established for classification of products. Products may not be available in all categories. Please contact your local Avago representative for further clarification/information.

Precautions:

Lead Forming:

- The leads of an LED lamp may be preformed or cut to length prior to insertion and soldering on PC board.
- For better control, it is recommended to use proper tool to precisely form and cut the leads to applicable length rather than doing it manually.
- If manual lead cutting is necessary, cut the leads after the soldering process. The solder connection forms a mechanical ground which prevents mechanical stress due to lead cutting from traveling into LED package. This is highly recommended for hand solder operation, as the excess lead length also acts as small heat sink.

Soldering and Handling:

- Care must be taken during PCB assembly and soldering process to prevent damage to the LED component.
- LED component may be effectively hand soldered to PCB. However, it is only recommended under unavoidable circumstances such as rework. The closest manual soldering distance of the soldering heat source (soldering iron’s tip) to the body is 1.59mm. Soldering the LED using soldering iron tip closer than 1.59mm might damage the LED.

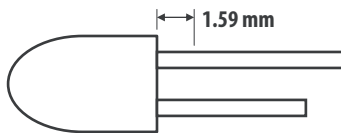

- ESD precaution must be properly applied on the soldering station and personnel to prevent ESD damage to the LED component that is ESD sensitive. Do refer to Avago application note AN 1142 for details. The soldering iron used should have grounded tip to ensure electrostatic charge is properly grounded.
- Recommended soldering condition:

	Wave Soldering^{[1],[2]}	Manual Solder Dipping
Pre-heat Temperature	105°C Max.	–
Pre-heat Time	60 sec Max.	–
Peak Temperature	250°C Max.	260°C Max.
Dwell Time	3 sec Max.	5 sec Max.

Note:

1. Above conditions refers to measurement with thermocouple mounted at the bottom of PCB.
2. It is recommended to use only bottom preheaters in order to reduce thermal stress experienced by LED.

- Wave soldering parameters must be set and maintained according to the recommended temperature and dwell time. Customer is advised to perform daily check on the soldering profile to ensure that it is always conforming to recommended soldering conditions.

Note:

1. PCB with different size and design (component density) will have different heat mass (heat capacity). This might cause a change in temperature experienced by the board if same wave soldering setting is used. So, it is recommended to re-calibrate the soldering profile again before loading a new type of PCB.
 2. Customer is advised to take extra precaution during wave soldering to ensure that the maximum wave temperature does not exceed 250°C and the solder contact time does not exceeding 3sec. Over-stressing the LED during soldering process might cause premature failure to the LED due to delamination.
- Any alignment fixture that is being applied during wave soldering should be loosely fitted and should not apply weight or force on LED. Non metal material is recommended as it will absorb less heat during wave soldering process.
 - At elevated temperature, LED is more susceptible to mechanical stress. Therefore, PCB must allowed to cool down to room temperature prior to handling, which includes removal of alignment fixture or pallet.
 - If PCB board contains both through hole (TH) LED and other surface mount components, it is recommended that surface mount components be soldered on the top side of the PCB. If surface mount need to be on the bottom side, these components should be soldered using reflow soldering prior to insertion the TH LED.
 - Recommended PC board plated through holes (PTH) size for LED component leads.

LED Component Lead Size	Diagonal	Plated Through Hole Diameter
0.45 x 0.45 mm (0.018 x 0.018 inch)	0.636 mm (0.025 inch)	0.98 to 1.08 mm (0.039 to 0.043 inch)
0.50 x 0.50 mm (0.020 x 0.020 inch)	0.707 mm (0.028 inch)	1.05 to 1.15 mm (0.041 to 0.045 inch)

- Over-sizing the PTH can lead to twisted LED after clinching. On the other hand under sizing the PTH can cause difficulty inserting the TH LED.

Refer to application note AN5334 for more information about soldering and handling of TH LED lamps.

Example of Wave Soldering Temperature Profile for TH LED

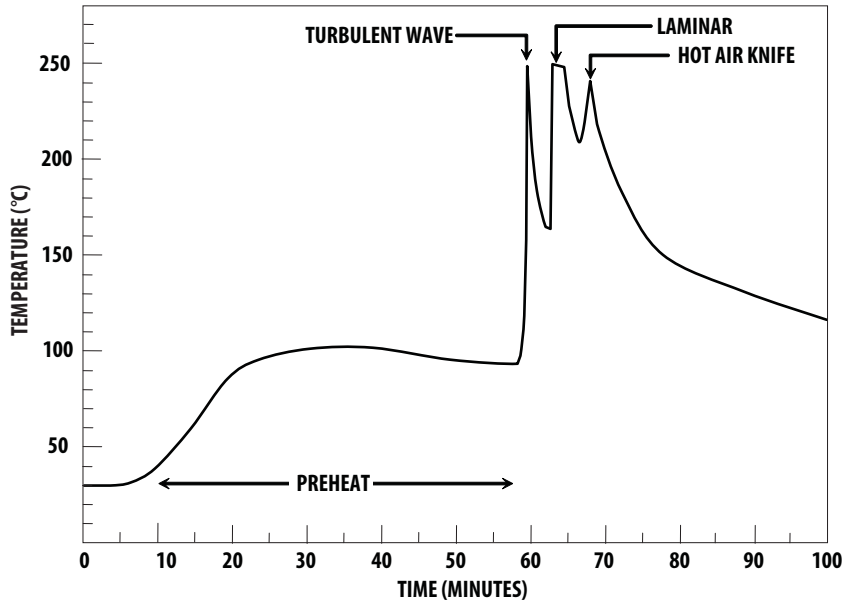

Recommended solder:
 Sn63 (Leaded solder alloy)
 SAC305 (Lead free solder alloy)

Flux: Rosin flux

Solder bath temperature:
 245°C ± 5°C (maximum peak temperature = 250°C)

Dwell time: 1.5 sec – 3.0 sec (maximum = 3sec)

Note: Allow for board to be sufficiently cooled to room temperature before exerting mechanical force.

Ammo Packs Drawing

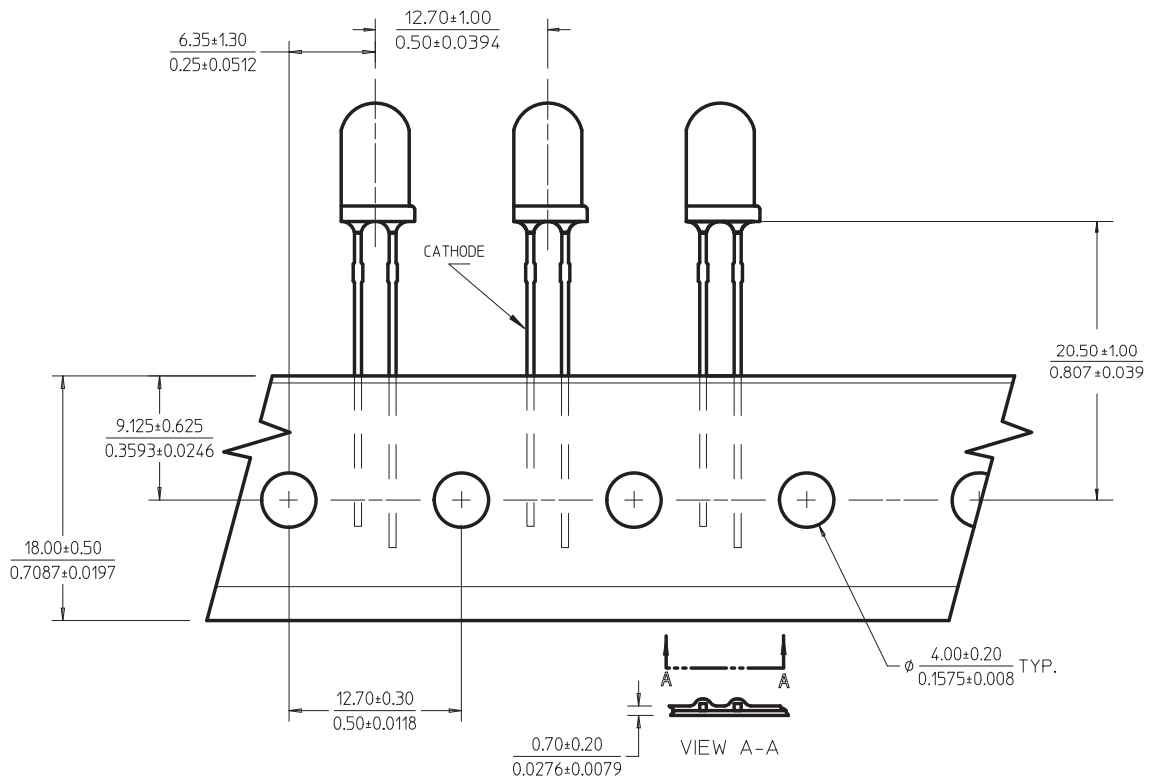

Packaging Box for Ammo Packs











Note: The dimension for ammo pack is applicable for the device with standoff and without standoff.

Packaging Label:

(i) Avago Mother Label: (Available on packaging box of ammo pack and shipping box)

AVAGO TECHNOLOGIES	
STANDARD LABEL LS0002	
RoHS Compliant	
e3 max temp 250C	
(1P) Item: Part Number	(Q) QTY: Quantity
(1T) Lot: Lot Number	CAT: Intensity Bin
LPN:	BIN: Color Bin
(9D)MFG Date: Manufacturing Date	
<hr/>	
(P) Customer Item:	
(V) Vendor ID:	(9D) Date Code: Date Code
<hr/>	
DeptID:	Made In: Country of Origin

(ii) Avago Baby Label (Only available on bulk packaging)

		RoHS Compliant	
Lamps Baby Label		e3 max temp 250C	
(1P) PART #: Part Number			
(1T) LOT #: Lot Number			
(9D)MFG DATE: Manufacturing Date	QUANTITY: Packing Quantity		
C/O: Country of Origin			
Customer P/N:	CAT: Intensity Bin		
Supplier Code:	BIN: Color Bin		
	DATECODE: Date Code		

For product information and a complete list of distributors, please go to our web site: www.avagotech.com

Avago, Avago Technologies, and the A logo are trademarks of Avago Technologies in the United States and other countries. Data subject to change. Copyright © 2005-2012 Avago Technologies. All rights reserved.
AV02-0965EN - March 13, 2012



Компания «Life Electronics» занимается поставками электронных компонентов импортного и отечественного производства от производителей и со складов крупных дистрибьюторов Европы, Америки и Азии.

С конца 2013 года компания активно расширяет линейку поставок компонентов по направлению коаксиальный кабель, кварцевые генераторы и конденсаторы (керамические, пленочные, электролитические), за счёт заключения дистрибьюторских договоров

Мы предлагаем:

- Конкуренспособные цены и скидки постоянным клиентам.
- Специальные условия для постоянных клиентов.
- Подбор аналогов.
- Поставку компонентов в любых объемах, удовлетворяющих вашим потребностям.
- Приемлемые сроки поставки, возможна ускоренная поставка.
- Доставку товара в любую точку России и стран СНГ.
- Комплексную поставку.
- Работу по проектам и поставку образцов.
- Формирование склада под заказчика.
- Сертификаты соответствия на поставляемую продукцию (по желанию клиента).
- Тестирование поставляемой продукции.
- Поставку компонентов, требующих военную и космическую приемку.
- Входной контроль качества.
- Наличие сертификата ISO.

В составе нашей компании организован Конструкторский отдел, призванный помогать разработчикам, и инженерам.

Конструкторский отдел помогает осуществить:

- Регистрацию проекта у производителя компонентов.
- Техническую поддержку проекта.
- Защиту от снятия компонента с производства.
- Оценку стоимости проекта по компонентам.
- Изготовление тестовой платы монтаж и пусконаладочные работы.



Тел: +7 (812) 336 43 04 (многоканальный)

Email: org@lifeelectronics.ru