

# Cree® XLamp® CMT1925 LED



## PRODUCT DESCRIPTION

The Cree XLamp® High-Current LED Array family is optimized for best-in-class lumen output, efficacy and reliability at high drive currents. XLamp CMT LEDs deliver performance in industry-compatible packages and LESes, enabling lighting manufacturers to upgrade their designs for applications such as track, downlight and outdoor lighting. XLamp High-Current LED Arrays are available in 2-step, 3-step and 5-step EasyWhite® bins.

## FEATURES

- 14.5-mm optical source
- Available in 70-, 80- and 90- and 95-minimum CRI options
- Cree EasyWhite® 2-, 3- and 5-step binning
- Premium Color 2- and 3-step binning
- Forward voltage option: 36-V class
- 85 °C binning and characterization
- Maximum drive current: 1700 mA
- 115° viewing angle, uniform chromaticity profile
- Top-side solder connections
- RoHS and REACH compliant
- UL® recognized component (E349212)

## TABLE OF CONTENTS

Characteristics .....	2
Operating Limits.....	2
Flux Characteristics, EasyWhite® Order Codes and Bins .....	3
Flux Characteristics, Premium Color Order Codes and Bins .....	4
Relative Spectral Power Distribution, EasyWhite® LEDs.....	5
Relative Spectral Power Distribution, Premium Color LEDs.....	6
Electrical Characteristics.....	8
Relative Luminous Flux.....	9
Typical Spatial Distribution.....	9
Performance Groups - Chromaticity .....	10
Premium Color Performance Groups - Chromaticity .....	11
Cree EasyWhite® Bins Plotted on the 1931 CIE Color Space .....	12
Cree Premium Color Bins Plotted on the 1931 CIE Color Space .....	13
Bin and Order Code Formats .....	15
Mechanical Dimensions .....	16
Thermal Design .....	17
Notes .....	18
Packaging.....	19



**CHARACTERISTICS**

Characteristics	Unit	Minimum	Typical	Maximum
Viewing angle (FWHM)	degrees		115	
ESD withstand voltage (JEDEC JS-001-2012)	V		Class 3A	
DC forward current	mA			1700*
Reverse current	mA			0.1
Forward voltage (@ 700 mA, 85 °C)	V		33.7	37.6

\* Refer to the Operating Limits section.

**OPERATING LIMITS**

The maximum current rating of the CMT1925 depends on the case temperature (Tc) when the LED has reached thermal equilibrium under steady-state operation. The graphs shown below assume that the system design employs good thermal management (thermal interface material and heat sink) and may vary when poor thermal management is employed. Either solder pad shown in the Mechanical Dimensions section on page 16 can be used as the Tc measurement point.

Another important factor in good thermal management is the temperature of the Light Emitting Surface (LES). Cree recommends a maximum LES temperature of 140 °C to ensure optimal LED lifetime. Please refer to the Thermal Design section on page 13 for more information on LES temperature measurement.

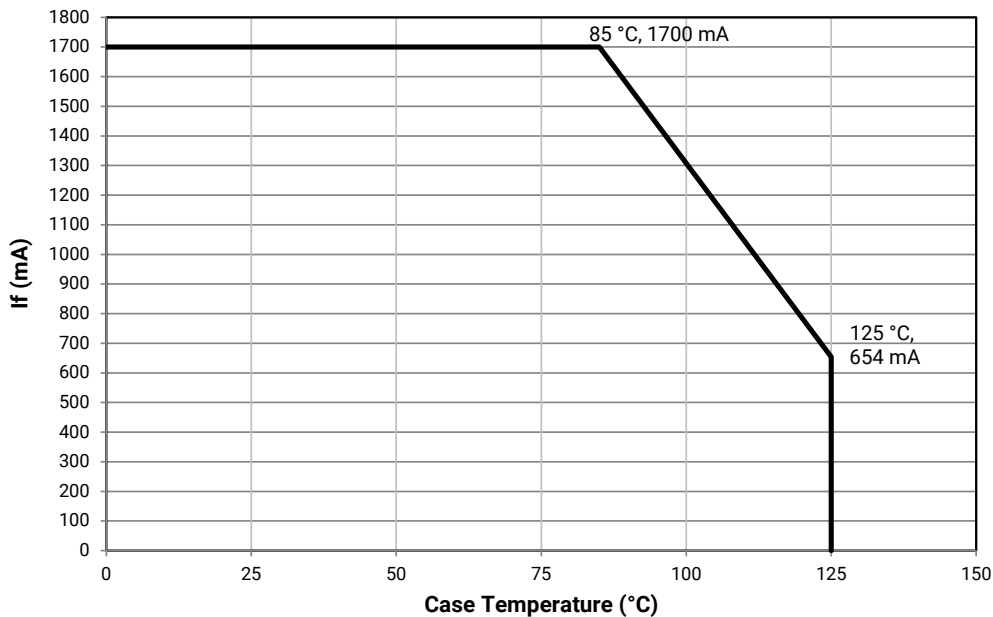

**FLUX CHARACTERISTICS, EASYWHITE® ORDER CODES AND BINS ( $I_F = 700 \text{ mA}$ ,  $T_J = 85 \text{ °C}$ )**

The following table provides order codes for XLamp CMT1925 LEDs. For a complete description of the order code nomenclature, please see the Bin and Order Code Formats section (page 15).

Nominal CCT	CRI		Minimum Luminous Flux (lm)	Typical Luminous Flux (lm)	2-Step		3-Step		5-Step	
	Min.	Typ			Group	Order Code	Group	Order Code	Group	Order Code
6500 K	70	73	3626	3899					65E	CMT1925-0000-000N0B0A65E
	80	82	3388	3642					65E	CMT1925-0000-000N0H0A65E
5700 K	70	73	3700	3979					57E	CMT1925-0000-000N0B0A57E
	80	82	3457	3717					57E	CMT1925-0000-000N0H0A57E
	90	92	2940	3161			57G	CMT1925-0000-000N0U0A57G		
5000 K	70	73	3593	3863					50E	CMT1925-0000-000N0B0A50E
	80	82	3356	3609			50G	CMT1925-0000-000N0H0A50G		
	90	92	2940	3161			50G	CMT1925-0000-000N0U0A50G		
4000 K	70	73	3566	3834					40E	CMT1925-0000-000N0B0A40E
	80	82	3318	3568	40H	CMT1925-0000-000N0H0A40H	40G	CMT1925-0000-000N0H0A40G		
	90	92	2857	3072	40H	CMT1925-0000-000N0U0A40H	40G	CMT1925-0000-000N0U0A40G		
3500 K	80	82	3237	3481	35H	CMT1925-0000-000N0H0A35H	35G	CMT1925-0000-000N0H0A35G		
	90	92	2779	2988	35H	CMT1925-0000-000N0U0A35H	35G	CMT1925-0000-000N0U0A35G		
3000 K	70	73	3318	3568					30E	CMT1925-0000-000N0B0A30E
	80	82	3143	3380	30H	CMT1925-0000-000N0H0A30H	30G	CMT1925-0000-000N0H0A30G		
	90	92	2658	2858	30H	CMT1925-0000-000N0U0A30H	30G	CMT1925-0000-000N0U0A30G		
2700 K	80	82	3016	3243	27H	CMT1925-0000-000N0H0A27H	27G	CMT1925-0000-000N0H0A27G		
	90	92	2537	2728	27H	CMT1925-0000-000N0U0A27H	27G	CMT1925-0000-000N0U0A27G		
2200 K	80	82	2658	2858			22G	CMT1925-0000-000N0H0A22G		

- Notes
- Cree maintains a tolerance of  $\pm 7\%$  on flux and power measurements,  $\pm 0.005$  on chromaticity (CCx, CCy) measurements and a tolerance of  $\pm 2$  on CRI measurements. See the Measurements section (page 18).
  - For 80 CRI minimum LEDs, CRI R9 minimum is 0 with a  $\pm 2$  tolerance. For 90 CRI minimum LEDs, CRI R9 typical is 60.

**FLUX CHARACTERISTICS, PREMIUM COLOR ORDER CODES AND BINS ( $I_F = 700 \text{ mA}$ ,  $T_J = 85 \text{ °C}$ )**
**Fidelity**

Nominal CCT	CRI*		Minimum Luminous Flux (lm)	Typical Luminous Flux (lm)	2-Step	
	Min.	Typ			Group	Order Code
4000 K	95	98	2559	2752	L5A	CMT1925-0000-000N0Z0AL5A
3500 K	95	98	2491	2678	35H	CMT1925-0000-000N0Z0A35H
3000 K	95	98	2329	2504	30H	CMT1925-0000-000N0Z0A30H
2700 K	95	98	2205	2371	27H	CMT1925-0000-000N0Z0A27H

**Specialty**

Nominal CCT	CRI		Minimum Luminous Flux (lm)	Typical Luminous Flux (lm)	2-Step		3-Step			
	Min.	Typ			Group	Order Code	Group	Order Code	Group	Order Code
3100 K	90	92	2658	2858			31Q	CMT1925-0000-000N0U0A31Q		
3000 K	80	82	3143	3380	L7B	CMT1925-0000-000N0H0AL7B				
	90	92	2658	2858			30Q	CMT1925-0000-000N0U0A30Q	30U	CMT1925-0000-000N0U0A30U
	95	98	2329	2504	L7C	CMT1925-0000-000N0Z0AL7C				

**Notes**

- Cree maintains a tolerance of  $\pm 7\%$  on flux and power measurements,  $\pm 0.005$  on chromaticity (CCx, CCy) measurements and a tolerance of  $\pm 2$  on CRI measurements. See the Measurements section (page 18).
- For 80 CRI minimum LEDs, CRI R9 minimum is 0 with a  $\pm 2$  tolerance. For 90 CRI minimum LEDs, CRI R9 typical is 60.

RELATIVE SPECTRAL POWER DISTRIBUTION, EASYWHITE® LEDS

The following graphs are the result of a series of pulsed measurements at 700 mA and  $T_j = 85^\circ\text{C}$ .

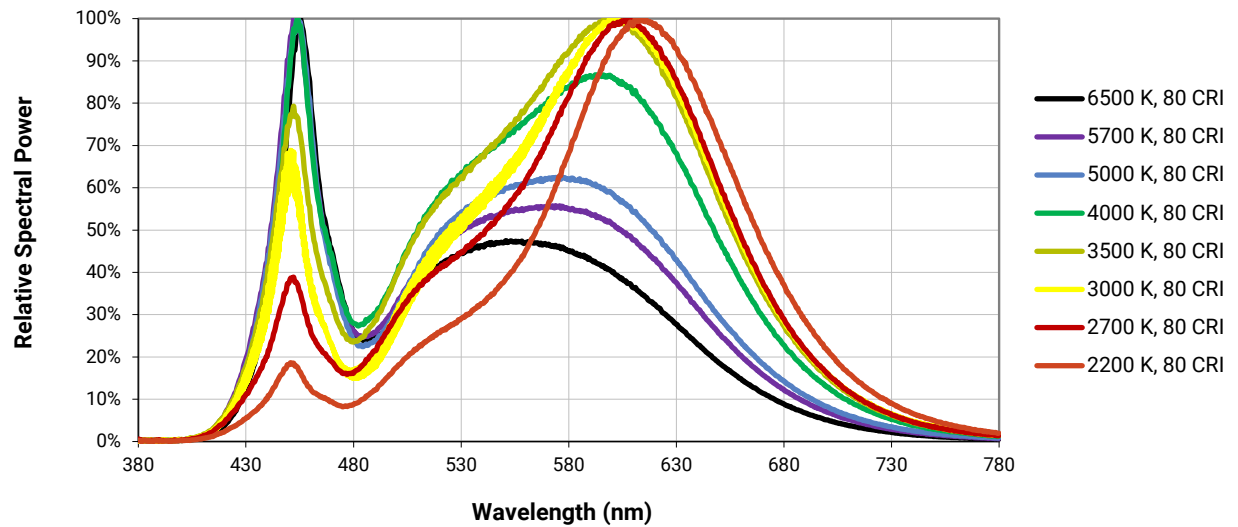
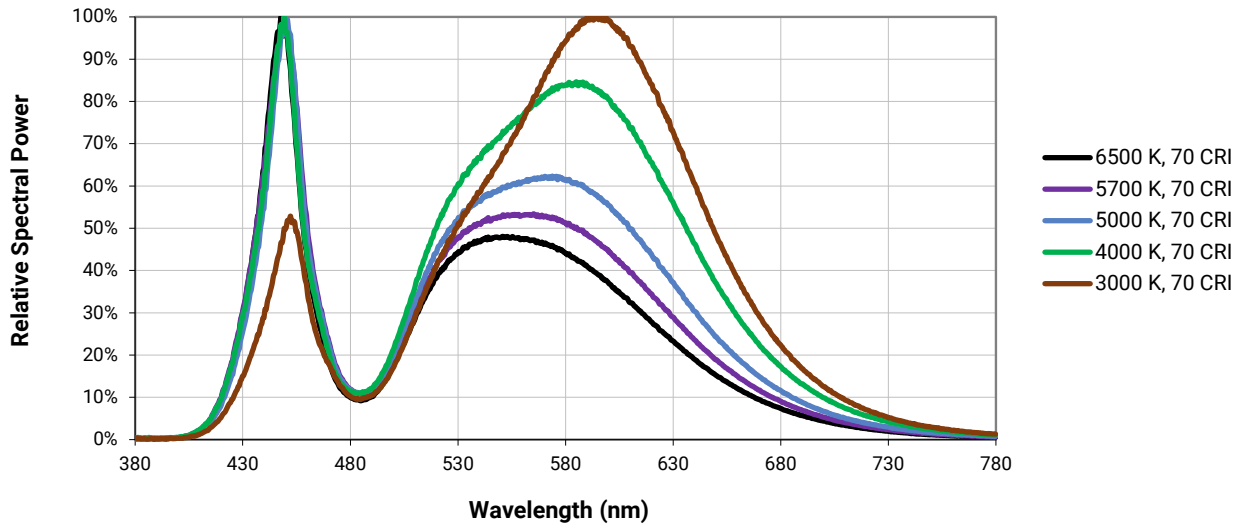

**RELATIVE SPECTRAL POWER DISTRIBUTION, EASYWHITE® LEDs - CONTINUED**



**RELATIVE SPECTRAL POWER DISTRIBUTION, PREMIUM COLOR LEDs**

The following graphs are the result of a series of pulsed measurements at 700 mA and  $T_j = 85^\circ\text{C}$ .

**Fidelity**



**RELATIVE SPECTRAL POWER DISTRIBUTION, PREMIUM COLOR LEDS - CONTINUED**

**Specialty**



**ELECTRICAL CHARACTERISTICS**

The following graph is the result of a series of steady-state measurements.

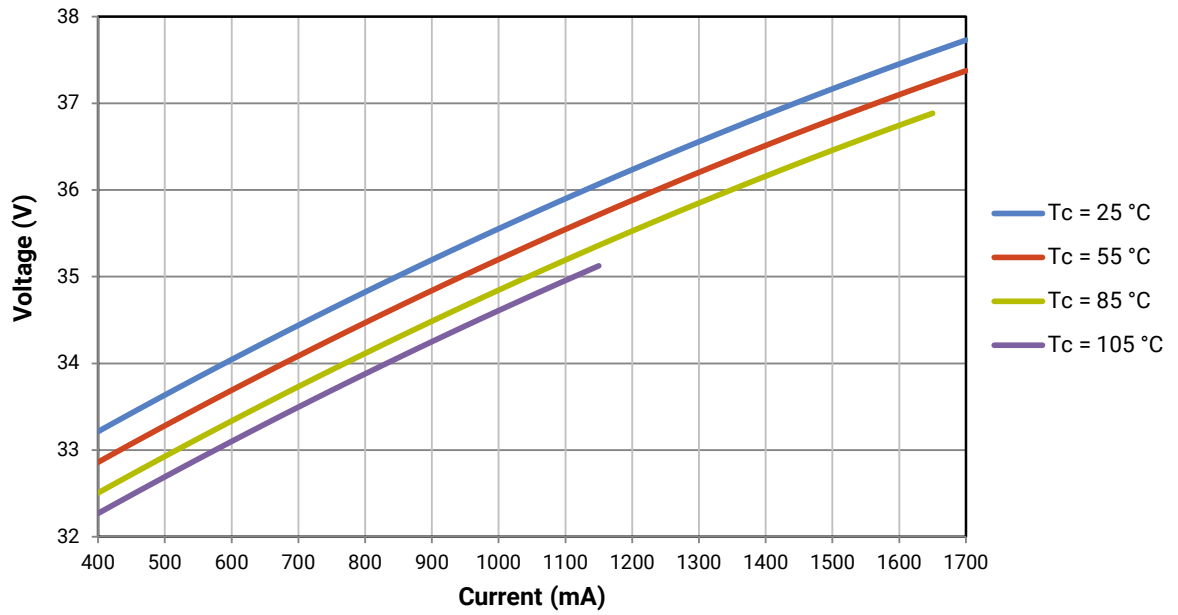



### RELATIVE LUMINOUS FLUX

The relative luminous flux values provided below are the ratio of:

- Measurements of CMT1925 at steady-state operation at the given conditions, divided by
- Flux measured during binning, which is a pulsed measurement at 700 mA at  $T_j = 85^\circ\text{C}$ .

For example, at steady-state operation of  $T_c = 25^\circ\text{C}$ ,  $I_f = 900\text{ mA}$ , the relative luminous flux ratio is 140% in the chart below. A CMT1925 LED that measures 3380 lm during binning will deliver 4732 lm ( $3380 \times 1.4$ ) at steady-state operation of  $T_c = 25^\circ\text{C}$ ,  $I_f = 900\text{ mA}$ .

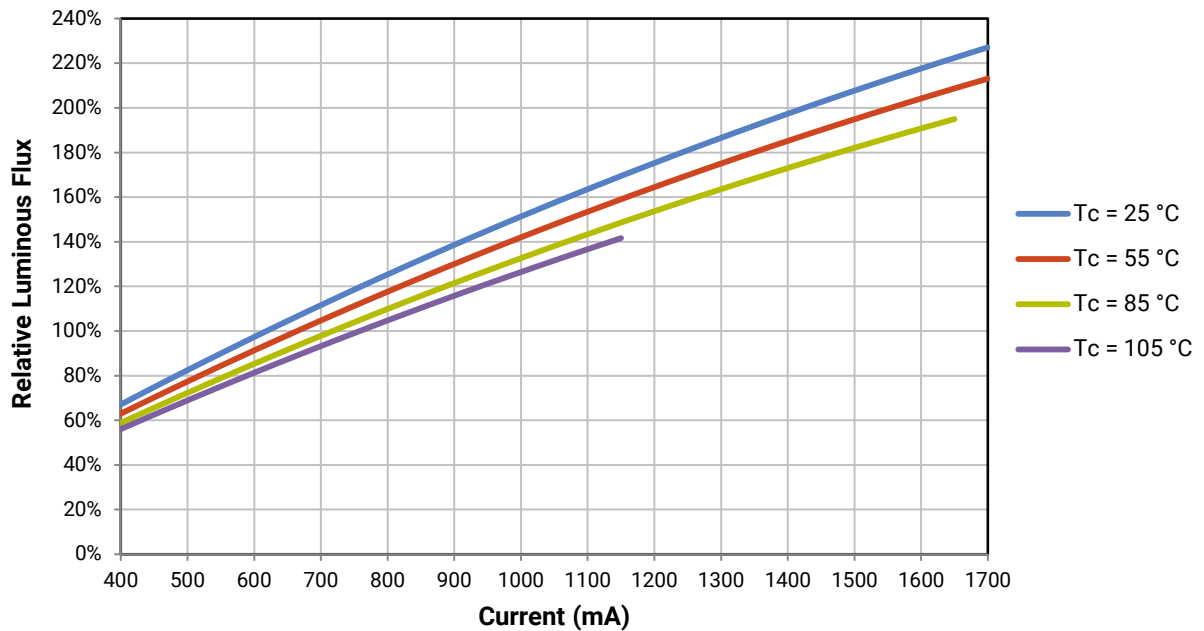

### TYPICAL SPATIAL DISTRIBUTION

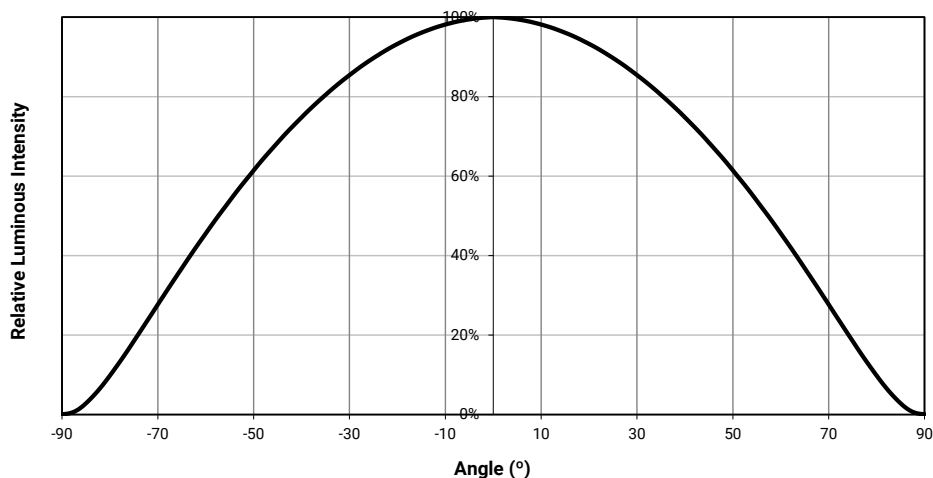

**PERFORMANCE GROUPS - CHROMATICITY ( $T_j = 85\text{ }^\circ\text{C}$ )**

XLamp CMT1925 LEDs are tested for chromaticity and placed into one of the regions defined by the following bounding coordinates.

EasyWhite Color Temperatures – 2-Step			
Code	CCT	x	y
40H	4000 K	0.3777	0.3739
		0.3797	0.3816
		0.3861	0.3855
		0.3838	0.3777
35H	3500 K	0.4022	0.3858
		0.4053	0.3942
		0.4125	0.3977
		0.4091	0.3891
30H	3000 K	0.4287	0.3975
		0.4328	0.4064
		0.4390	0.4086
		0.4347	0.3996
27H	2700 K	0.4524	0.4048
		0.4574	0.4140
		0.4633	0.4154
		0.4581	0.4062

EasyWhite Color Temperatures – 3-Step Ellipse						
Bin Code	CCT	Center Point		Major Axis	Minor Axis	Rotation Angle (°)
		x	y	a	b	
57G	5700 K	0.3287	0.3417	0.00738	0.00360	72.0
50G	5000 K	0.3447	0.3553	0.00840	0.00312	65.0
40G	4000 K	0.3818	0.3797	0.00939	0.00402	53.7
35G	3500 K	0.4073	0.3917	0.00927	0.00414	54.0
30G	3000 K	0.4338	0.4030	0.00834	0.00408	53.2
27G	2700 K	0.4577	0.4099	0.00834	0.00420	48.5
22G	2200 K	0.5066	0.4158	0.00980	0.00480	45.5

EasyWhite Color Temperatures – 5-Step Ellipse						
Bin Code	CCT	Center Point		Major Axis	Minor Axis	Rotation Angle (°)
		x	y	a	b	
65E	6500 K	0.3123	0.3282	0.01110	0.00550	61.0
57E	5700 K	0.3287	0.3417	0.01230	0.00600	72.0
50E	5000 K	0.3447	0.3553	0.01400	0.00520	65.0
40E	4000 K	0.3818	0.3797	0.01565	0.00670	53.7
30E	3000 K	0.4338	0.4030	0.01390	0.00680	53.2

**PREMIUM COLOR PERFORMANCE GROUPS - CHROMATICITY ( $T_j = 85\text{ }^\circ\text{C}$ )**

XLamp CMT1925 LEDs are tested for chromaticity and placed into one of the regions defined by the following bounding coordinates.

**Fidelity**

EasyWhite Color Temperatures – 2-Step			
Code	CCT	x	y
L5A	4000 K	0.3764	0.3711
		0.3784	0.3787
		0.3847	0.3826
		0.3825	0.3748
35H	3500 K	0.4022	0.3858
		0.4053	0.3942
		0.4125	0.3977
		0.4091	0.3891
30H	3000 K	0.4287	0.3975
		0.4328	0.4064
		0.4390	0.4086
		0.4347	0.3996
27H	2700 K	0.4524	0.4048
		0.4574	0.4140
		0.4633	0.4154
		0.4581	0.4062

**Specialty**

EasyWhite Color Temperatures – 2-Step			
Code	CCT	x	y
L7B	3000 K	0.4263	0.3848
		0.4296	0.3916
		0.4361	0.3938
		0.4326	0.3868
L7C	3000 K	0.4192	0.3754
		0.4224	0.3823
		0.4291	0.3847
		0.4257	0.3777

EasyWhite Color Temperatures – 3-Step Ellipse						
Bin Code	CCT	Center Point		Major Axis	Minor Axis	Rotation Angle (°)
		x	y	a	b	
31Q	3100 K	0.4236	0.3888	0.00848	0.00455	50.3
30Q	3000 K	0.4305	0.3935	0.00834	0.00408	53.2
30U	3000 K	0.4274	0.3837	0.00834	0.00408	53.2

**CREE EASYWHITE® BINS PLOTTED ON THE 1931 CIE COLOR SPACE ( $T_j = 85\text{ }^\circ\text{C}$ )**



**CREE PREMIUM COLOR BINS PLOTTED ON THE 1931 CIE COLOR SPACE ( $T_j = 85\text{ }^\circ\text{C}$ )**

**Fidelity (2-step)**



**CREE PREMIUM COLOR BINS PLOTTED ON THE 1931 CIE COLOR SPACE ( $T_j = 85^\circ\text{C}$ ) - CONTINUED**

**Speciality (2-step)**

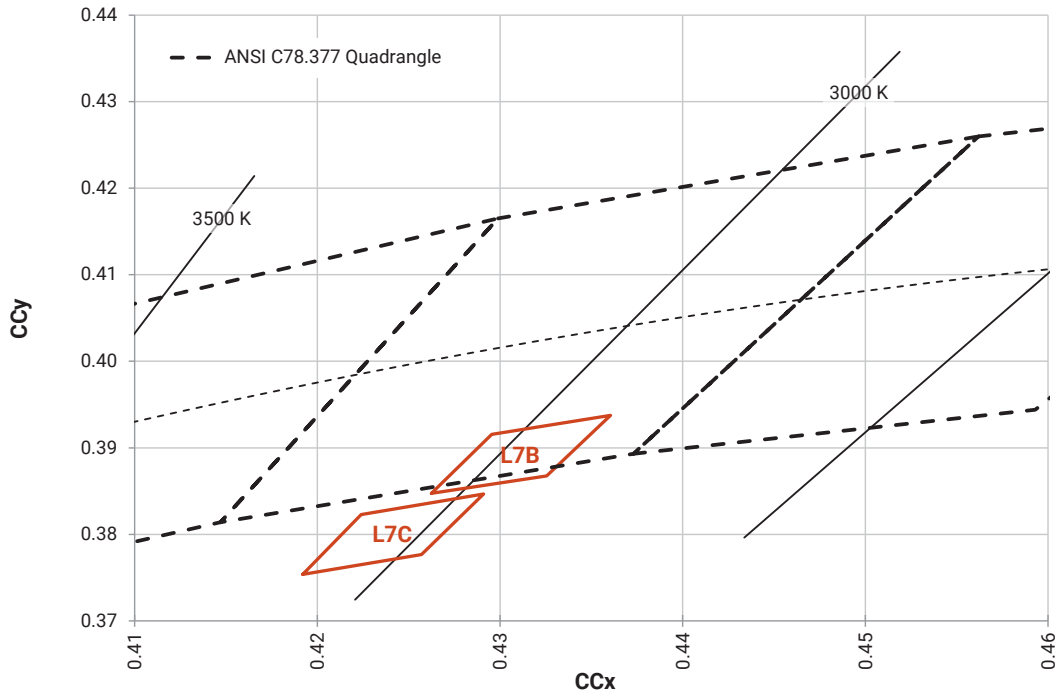

**Speciality (3-step)**

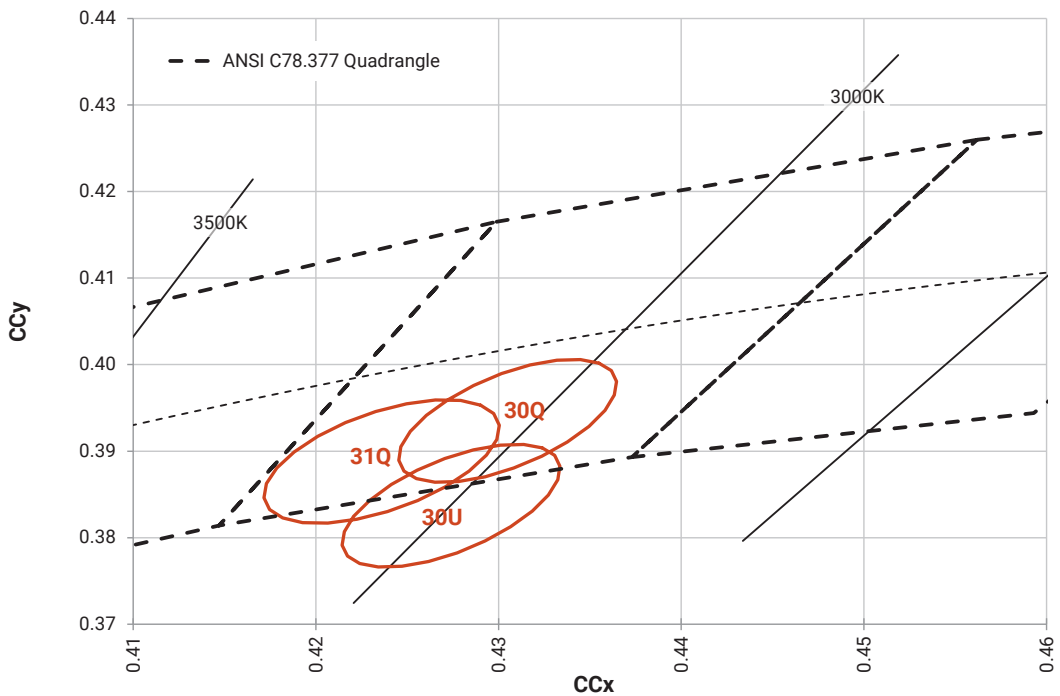

**BIN AND ORDER CODE FORMATS**

Bin codes and order codes are configured as follows:

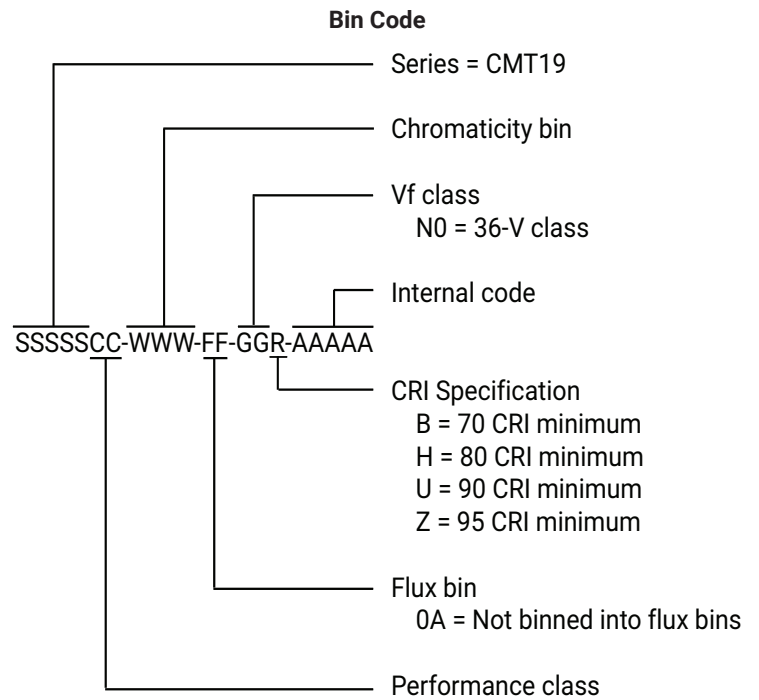
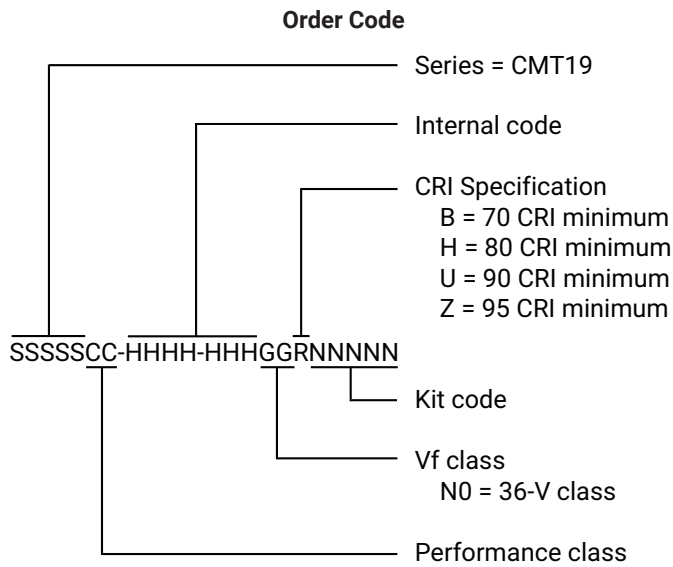

**MECHANICAL DIMENSIONS**

Dimensions are in mm.

Tolerances unless otherwise specified: ±.13

x° ± 1°

**Meaning of LED marking**

T1925N = 36-V CMT1925

X<sub>1</sub> X<sub>2</sub> X<sub>3</sub> X<sub>4</sub> X<sub>5</sub>

- X1 CCT
- 1 = 6500 K
  - 2 = 5700 K
  - 3 = 5000 K
  - 5 = 4000 K
  - 6 = 3500 K
  - 7 = 3000 K
  - 8 = 2700 K
  - A = 2200 K

- X2
- M = EasyWhite or Fidelity LED on the black-body line
  - Q = Specialty LED below the black-body line
  - U = Specialty LED below the black-body line

- X3 X4 Flux bin
- 0A = Not binned into flux bins

- X5 CRI
- B = 70 CRI min
  - H = 80 CRI min
  - U = 90 CRI min
  - Z = 95 CRI min

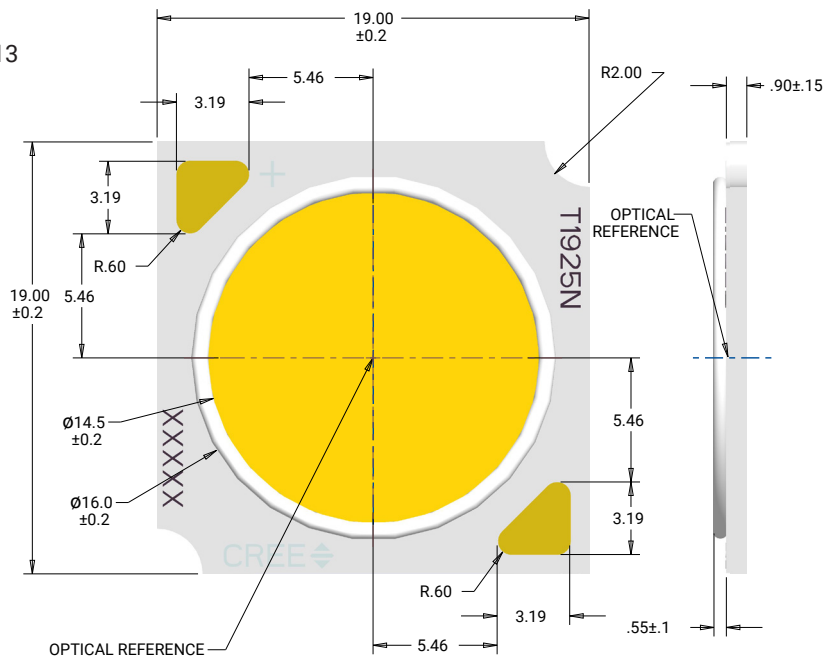

Tc measurement point: either the anode or cathode solder pad



**THERMAL DESIGN**

The CMT family of LED arrays can include over a hundred different LED die inside one package, and thus over a hundred different junction temperatures ( $T_j$ ). Cree has intentionally removed junction-temperature-based operating limits and replaced the commonplace maximum  $T_j$  calculations with maximum ratings based on forward current ( $I_f$ ) and case temperature ( $T_c$ ). No additional calculations are required to ensure the CMT LED is being operated within its designed limits. LES temperature measurement provides additional verification of good thermal design. Please refer to page 2 for the Operating Limit specification.

There is no need to calculate for  $T_j$  inside the package, as the thermal management design process, specifically from solder point ( $T_{sp}$ ) to ambient ( $T_a$ ), remains identical to any other LED component. For more information on thermal management of Cree XLamp LEDs, please refer to the [Thermal Management application note](#). For CMT soldering recommendations and more information on thermal interface materials (TIM), LES temperature measurement, and connection methods, please refer to the [Cree XLamp CM Family LEDs soldering and handling document](#).

To keep the CMT1925 LED at or below the maximum rated  $T_c$ , the case to ambient temperature thermal resistance ( $R_{c-a}$ ) must be at or below the maximum  $R_{c-a}$  value shown on the following graph, depending on the operating environment. The y-axis in the graph is a base 10 logarithmic scale.

As the figure at right shows, the  $R_{c-a}$  value is the sum of the thermal resistance of the TIM ( $R_{tim}$ ) plus the thermal resistance of the heat sink ( $R_{hs}$ ).

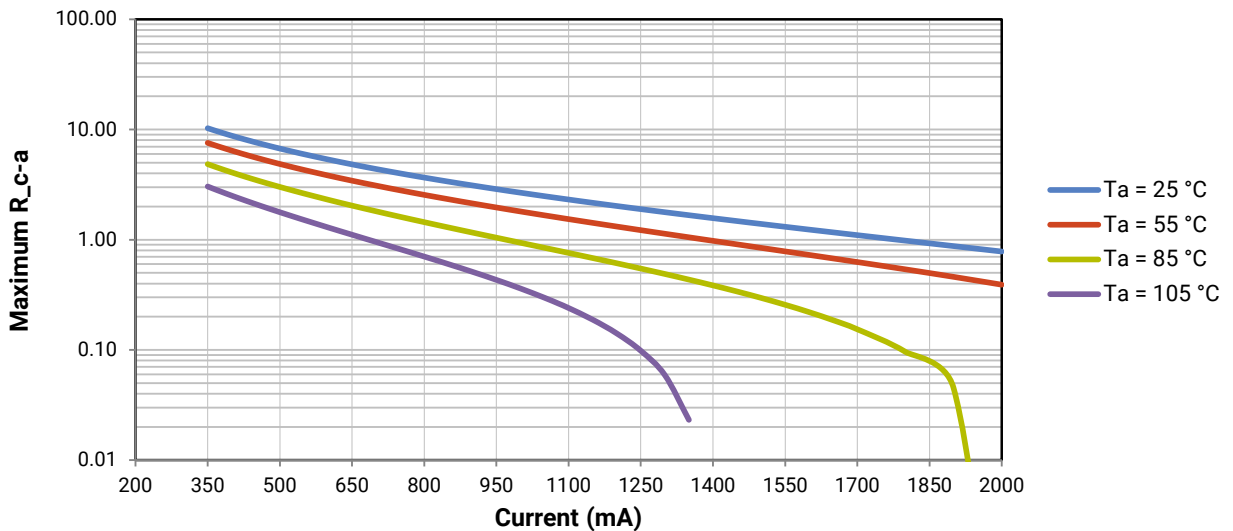

## NOTES

---

### Measurements

The luminous flux, radiant power, chromaticity, forward voltage and CRI measurements in this document are binning specifications only and solely represent product measurements as of the date of shipment. These measurements will change over time based on a number of factors that are not within Cree's control and are not intended or provided as operational specifications for the products. Calculated values are provided for informational purposes only and are not intended or provided as specifications.

### Pre-Release Qualification Testing

Please read the [LED Reliability Overview](#) for details of the qualification process Cree applies to ensure long-term reliability for XLamp LEDs and details of Cree's pre-release qualification testing for XLamp LEDs. Cree did not perform Room Temperature Operating Life (RTOL) testing on the CMT1925 LED.

### Lumen Maintenance

Cree now uses standardized IES LM-80-08 and TM-21-11 methods for collecting long-term data and extrapolating LED lumen maintenance. For information on the specific LM-80 data sets available for this LED, refer to the public [LM-80 results document](#).

Please read the [Long-Term Lumen Maintenance application note](#) for more details on Cree's lumen maintenance testing and forecasting. Please read the [Thermal Management application note](#) for details on how thermal design, ambient temperature, and drive current affect the LED junction temperature.

### RoHS Compliance

The levels of RoHS restricted materials in this product are below the maximum concentration values (also referred to as the threshold limits) permitted for such substances, or are used in an exempted application, in accordance with EU Directive 2011/65/EC (RoHS2), as implemented January 2, 2013. RoHS Declarations for this product can be obtained from your Cree representative or from the [Product Ecology](#) section of the Cree website.

### REACH Compliance

REACH substances of very high concern (SVHCs) information is available for this product. Since the European Chemical Agency (ECHA) has published notice of their intent to frequently revise the SVHC listing for the foreseeable future, please contact a Cree representative to insure you get the most up-to-date REACH SVHC Declaration. REACH banned substance information (REACH Article 67) is also available upon request.

### UL® Recognized Component

This product meets the requirements to be considered a UL Recognized Component with Level 4 enclosure consideration. The LED package or a portion thereof has been investigated as a fire and electrical enclosure per ANSI/UL 8750.

### Vision Advisory

**WARNING:** Do not look at an exposed lamp in operation. Eye injury can result. For more information about LEDs and eye safety, please refer to the [LED Eye Safety application note](#).

**PACKAGING**

Cree CMT1925 LEDs are packaged in trays of 20. Five trays are sealed in an anti-static bag and placed inside a carton, for a total of 100 LEDs per carton. Each carton contains 100 LEDs from the same performance bin.

Dimensions are in inches.  
Tolerances:  $\pm .13$   
 $x^{\circ} \pm 1^{\circ}$

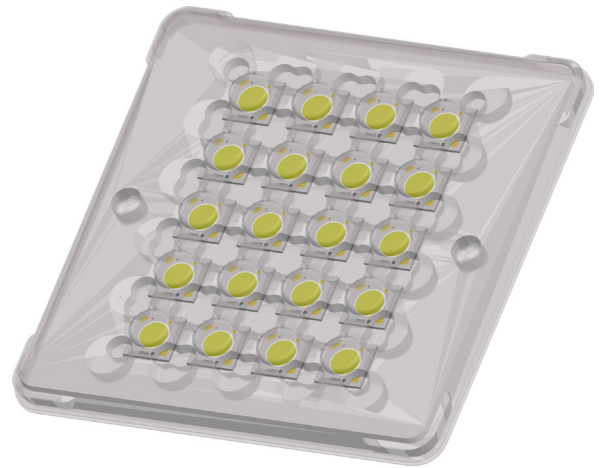
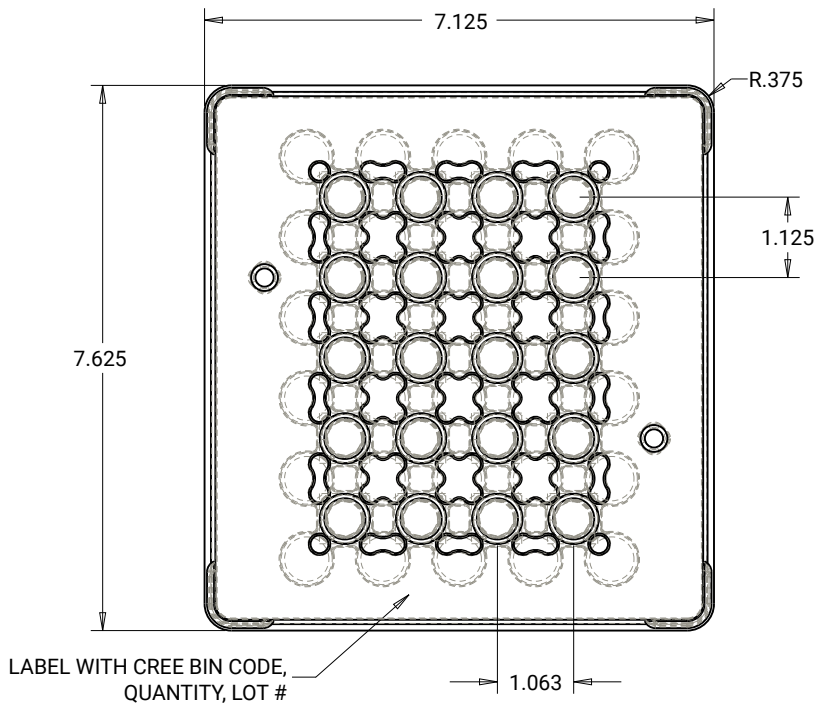

PATENT LABEL IS LOCATED ON UNDERSIDE OF CARTON

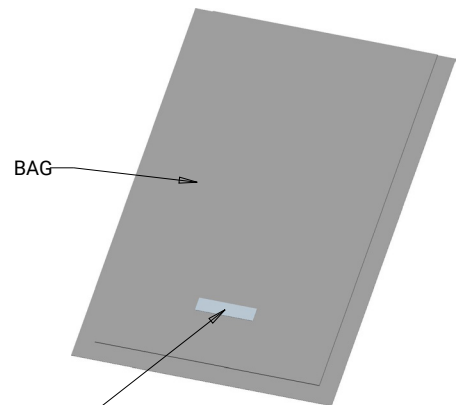
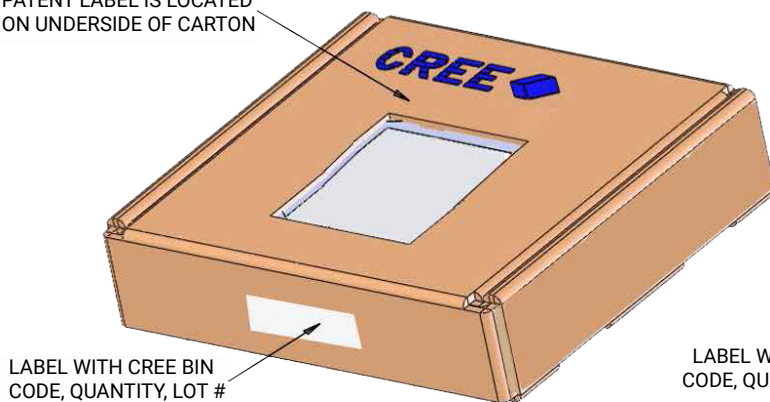

Компания «Life Electronics» занимается поставками электронных компонентов импортного и отечественного производства от производителей и со складов крупных дистрибьюторов Европы, Америки и Азии.

С конца 2013 года компания активно расширяет линейку поставок компонентов по направлению коаксиальный кабель, кварцевые генераторы и конденсаторы (керамические, пленочные, электролитические), за счёт заключения дистрибьюторских договоров

Мы предлагаем:

- Конкурентоспособные цены и скидки постоянным клиентам.
- Специальные условия для постоянных клиентов.
- Подбор аналогов.
- Поставку компонентов в любых объемах, удовлетворяющих вашим потребностям.
- Приемлемые сроки поставки, возможна ускоренная поставка.
- Доставку товара в любую точку России и стран СНГ.
- Комплексную поставку.
- Работу по проектам и поставку образцов.
- Формирование склада под заказчика.
- Сертификаты соответствия на поставляемую продукцию (по желанию клиента).
- Тестирование поставляемой продукции.
- Поставку компонентов, требующих военную и космическую приемку.
- Входной контроль качества.
- Наличие сертификата ISO.

В составе нашей компании организован Конструкторский отдел, призванный помогать разработчикам, и инженерам.

Конструкторский отдел помогает осуществить:

- Регистрацию проекта у производителя компонентов.
- Техническую поддержку проекта.
- Защиту от снятия компонента с производства.
- Оценку стоимости проекта по компонентам.
- Изготовление тестовой платы монтаж и пусконаладочные работы.



Тел: +7 (812) 336 43 04 (многоканальный)

Email: [org@lifeelectronics.ru](mailto:org@lifeelectronics.ru)