



Product Description

RFMD's CGR-0218Z is a high performance InGaP HBT MMIC Amplifier designed with the InGaP process technology for excellent reliability. A Darlington configuration is utilized for broadband performance. The heterojunction increases breakdown voltage and minimizes leakage current between junctions. The CGR-0218Z contains two amplifiers for use in wideband push-pull CATV amplifiers requiring excellent second order performance. The second and third order non-linearities are greatly improved in the push-pull configuration.

Features

- 5V Single Supply
- Excellent Linearity
- Two Amplifiers in Each SOIC-8 Package Simplify Push-Pull PC Board Layout
- SOIC-8 Package
- Available in Lead-Free, RoHS Compliant Packaging

Applications

- CATV Head Ends
- CATV Line Drivers
- DOCSIS Cable Modems

Optimum Technology Matching® Applied

- GaAs HBT
- GaAs MESFET
- InGaP HBT
- SiGe BiCMOS
- Si BiCMOS
- SiGe HBT
- GaAs pHEMT
- Si CMOS
- Si BJT
- GaN HEMT
- InP HBT
- RF MEMS
- LDMOS

Amplifier Configuration

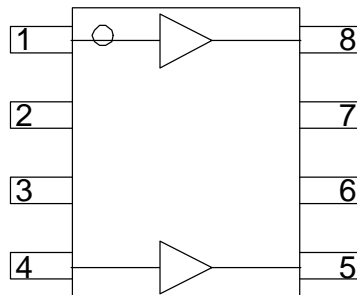

Parameter	Specification			Unit	Condition
	Min.	Typ.	Max.		
Small Signal Gain		17.3		dB	5 MHz to 210MHz
Gain Flatness		±0.2		dB	5 MHz to 210MHz
OIP ₃		42		dBm	5 MHz to 210MHz, Tone Spacing=1MHz, P _{OUT} per tone = +6dBm
P1dB		23		dBm	5 MHz to 210MHz
Input Return Loss		22		dB	5 MHz to 210MHz
Output Return Loss		22		dB	5 MHz to 210MHz
Noise Figure, Balun Insertion Loss Included		4.0		dB	5 MHz to 210MHz
CSO		80		dBc	7 Ch, Flat Tilt, +50dBmV
CTB		67		dBc	7 Ch, Flat Tilt, +50dBmV
XMOD		66		dBc	7 Ch, Flat Tilt, +50dBmV
Device Operating Voltage		5.0		V	
Device Operating Current		217		mA	5V V _{CC}
Thermal Resistance (Junction to Lead)		30		°C/W	Junction to case slug

Test Conditions: V_{CC}=5V, I_D=217 mA Typ., T_L=25 °C, Z_S=Z_L=75Ω, Push Pull Application Circuit

Absolute Maximum Ratings

Parameter	Rating	Unit
Max Device Current (I_D)	300	mA
Max Device Voltage (V_D)	6.0	V
Max RF Input Power	18	dBm
Max Junction Temp (T_J)	150	°C
Operating Temp Range (T_L)	-40 to +85	°C
Max Storage Temp	150	°C
Min Storage Temp	-40	°C

Operation of this device beyond any one of these limits may cause permanent damage. For reliable continuous operation, the device voltage and current must not exceed the maximum operating values specified in the table on page one.

Bias Conditions should also satisfy the following expression:

$$I_D V_D < (T_J - T_L) / R_{TH, j-l} \text{ and } T_L = T_{LEAD}$$



Caution! ESD sensitive device.

Exceeding any one or a combination of the Absolute Maximum Rating conditions may cause permanent damage to the device. Extended application of Absolute Maximum Rating conditions to the device may reduce device reliability. Specified typical performance or functional operation of the device under Absolute Maximum Rating conditions is not implied.

RoHS status based on EU Directive 2002/95/EC (at time of this document revision).

The information in this publication is believed to be accurate and reliable. However, no responsibility is assumed by RF Micro Devices, Inc. ("RFMD") for its use, nor for any infringement of patents, or other rights of third parties, resulting from its use. No license is granted by implication or otherwise under any patent or patent rights of RFMD. RFMD reserves the right to change component circuitry, recommended application circuitry and specifications at any time without prior notice.

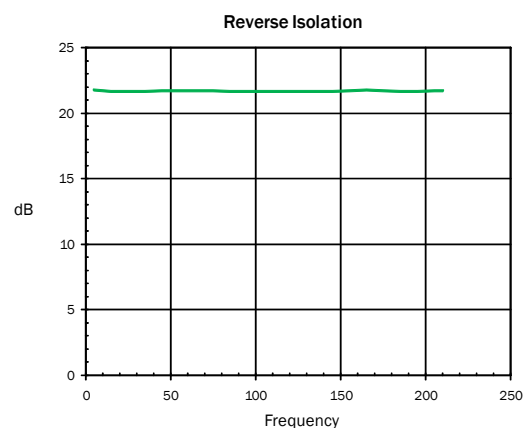
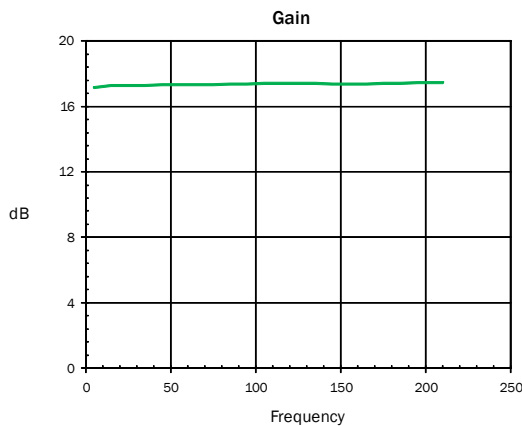

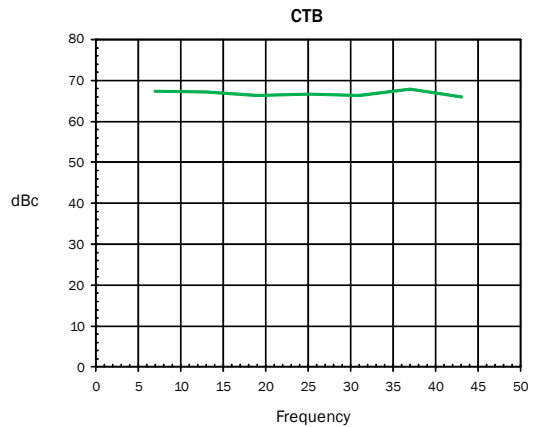
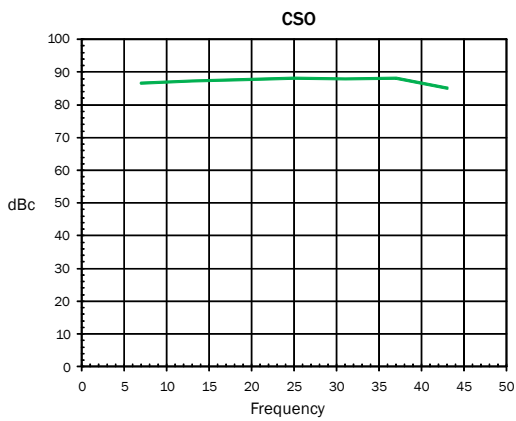
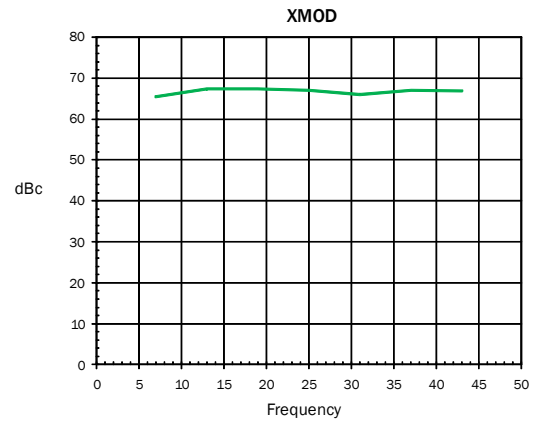
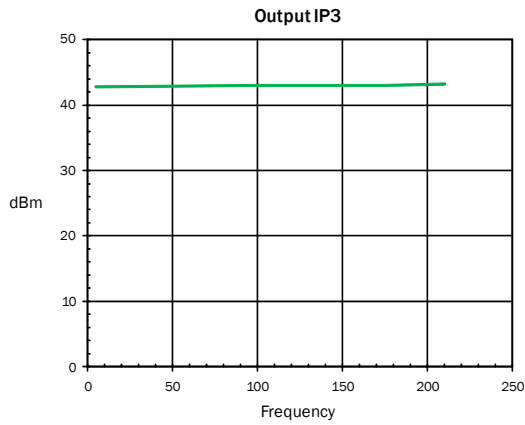
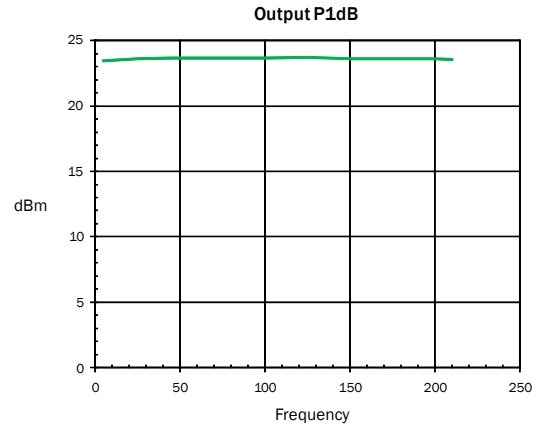
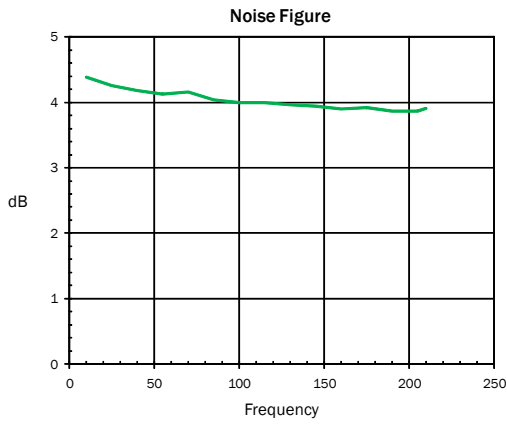

Evaluation Board Schematic

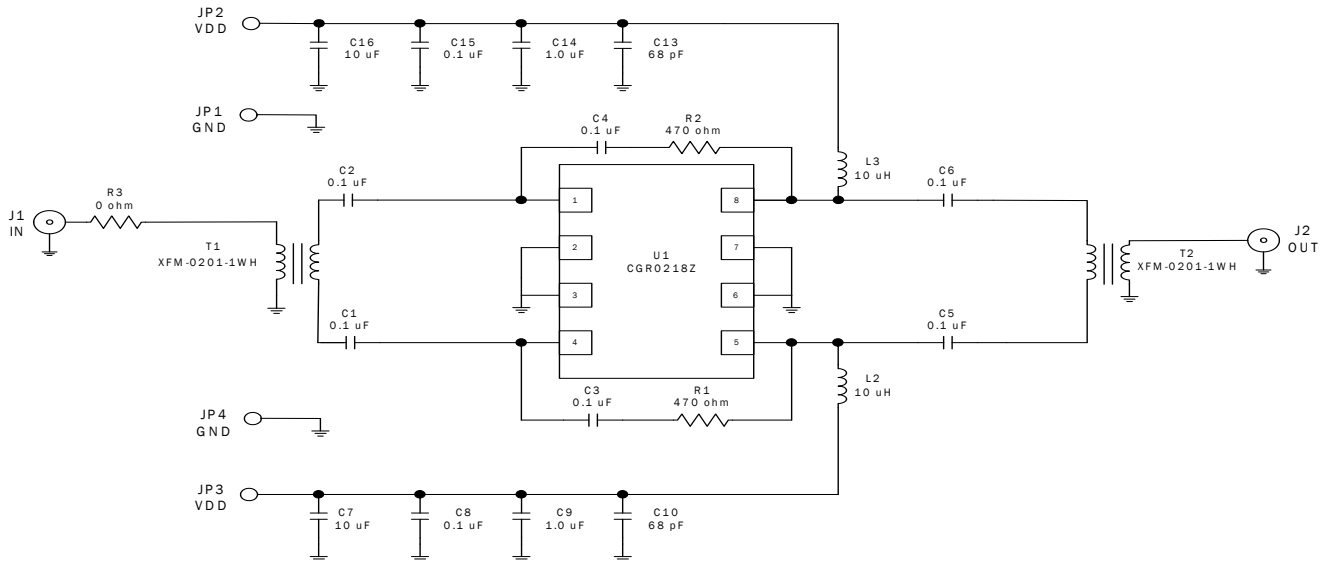

Evaluation Board Layout

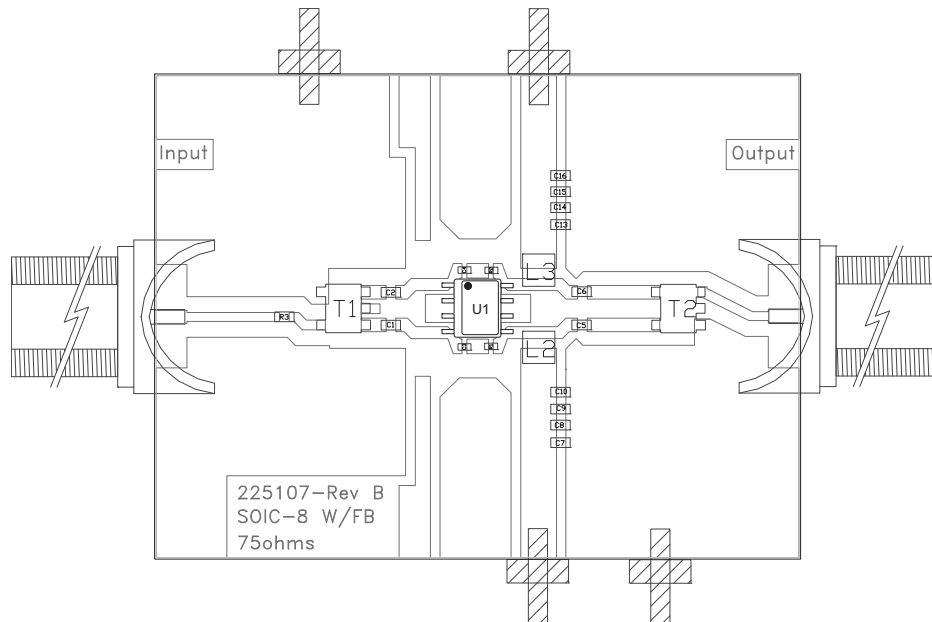

Value	QTY	Location
68pF	2	C10, C13
0.1uF	8	C1, C2, C3, C4, C5, C6, C8, C15
1.0uF	2	C9, C14
10uF	2	C7, C10
0Ω	1	R3
470Ω	2	R1, R2
10uH	2	L2, L3
RFMD™ XFM-0201-1WH	2	T1, T2

Pin	Function	Description
1	RF IN	RF input pin. External DC blocking capacitor is required.
2, 3, 6, 7	GND	Connection to ground. Use via holes for best performance to reduce lead inductance as close to ground leads as possible.
4	RF IN	Same as pin 1.
5	RF OUT/VCC	RF output and bias pin (open collector).
8	RF OUT/VCC	Same as pin 5.
EPAD	GND	Exposed area on the bottom side of the package must be soldered to the ground plane of the board for optimum thermal and RF performance. Several vias should be located under the EPAD as shown in the recommended land pattern.

Pin Out

Amplifier Configuration

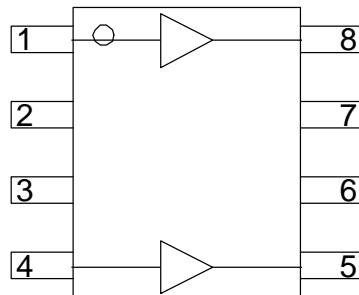

Suggested Pad Layout

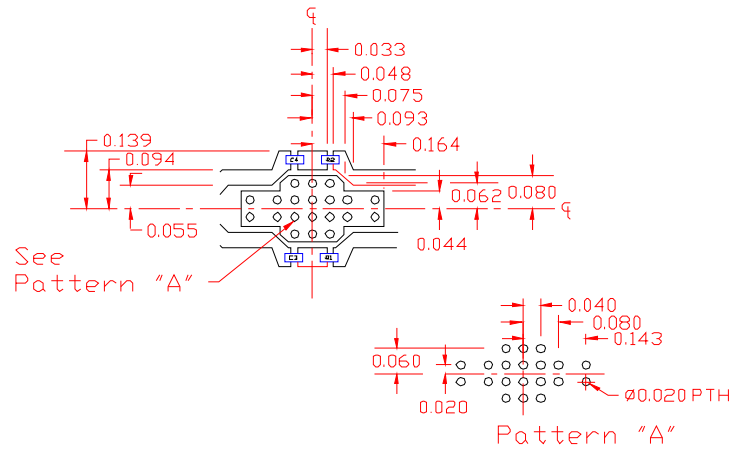

Package Drawing and Marking Package Type: SOIC-8

Dimensions in inches (millimeters)

Refer to drawing posted at www.rfmd.com for tolerances.

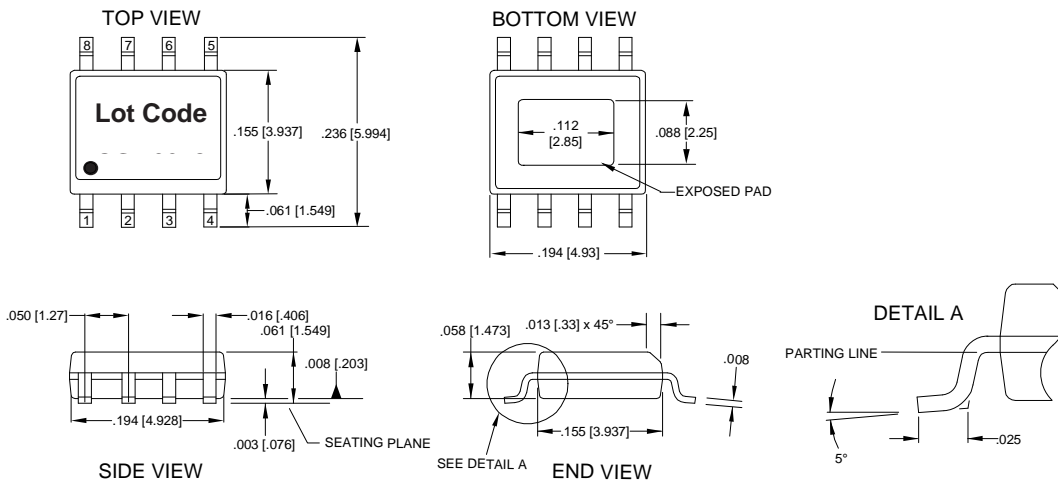

Ordering Information

Part Number	Description	Reel Size (in.)	Devices/Reel
CGR0218ZSB	5pcs Sample Bag	NA	NA
CGR0218ZSQ	25pcs Sample Bag	NA	NA
CGR0218ZSR	Lead Free, RoHS Compliant	7	100
CGR0218ZTR7	Lead Free, RoHS Compliant	7	750
CGR0218ZTR13	Lead Free, RoHS Compliant	13	2500
CGR0218PCBA-410	5 MHz to 210MHz Evaluation Board	NA	NA

CGR-0218Z



Компания «Life Electronics» занимается поставками электронных компонентов импортного и отечественного производства от производителей и со складов крупных дистрибьюторов Европы, Америки и Азии.

С конца 2013 года компания активно расширяет линейку поставок компонентов по направлению коаксиальный кабель, кварцевые генераторы и конденсаторы (керамические, пленочные, электролитические), за счёт заключения дистрибьюторских договоров

Мы предлагаем:

- Конкуренспособные цены и скидки постоянным клиентам.
- Специальные условия для постоянных клиентов.
- Подбор аналогов.
- Поставку компонентов в любых объемах, удовлетворяющих вашим потребностям.
- Приемлемые сроки поставки, возможна ускоренная поставка.
- Доставку товара в любую точку России и стран СНГ.
- Комплексную поставку.
- Работу по проектам и поставку образцов.
- Формирование склада под заказчика.
- Сертификаты соответствия на поставляемую продукцию (по желанию клиента).
- Тестирование поставляемой продукции.
- Поставку компонентов, требующих военную и космическую приемку.
- Входной контроль качества.
- Наличие сертификата ISO.

В составе нашей компании организован Конструкторский отдел, призванный помогать разработчикам, и инженерам.

Конструкторский отдел помогает осуществить:

- Регистрацию проекта у производителя компонентов.
- Техническую поддержку проекта.
- Защиту от снятия компонента с производства.
- Оценку стоимости проекта по компонентам.
- Изготовление тестовой платы монтаж и пусконаладочные работы.



Тел: +7 (812) 336 43 04 (многоканальный)

Email: org@lifeelectronics.ru