

NCP367

Battery Charge Front-End Protection, USB and AC/DC Supply Compliant

NCP367 is a charge path protection device which allows disconnecting the systems from its output pin in case wrong charging conditions are detected. The system is positive overvoltage protected up to +30 V. Thanks to a very low current consumption, the USB charge is compatible with this integrated component.

This device uses internal PMOS FET, making external devices unnecessary, which reduces the system cost and PCB area of the application board. First, NCP367 is able to instantaneously disconnect the output from the input if the input voltage exceeds the overvoltage threshold. Additional overcurrent protection function allows turning off internal PMOS FET when the charge current exceeds current limit, which is externally selectable.

The current limit value can be modified with control logic pin to divide it by internal gain, allowing USB 100 mA/500 mA charging or USB/Wall adapter charging up to overcurrent threshold. At the same time, Li ion Battery voltage is continuously monitored, providing more safety during the charge. Thermal shutdown protection is also available.

NCP367 provides a negative going flag ($\overline{\text{FLAG}}$) output, which alerts the system that a fault has occurred as overvoltage (power supply or battery voltage), overcurrent or thermal event.

In addition, the device has ESD-protected input (15 kV Air) when bypassed with a 1 μF or larger capacitor.

Features

- Overvoltage Protection Up to + 30 V
- Fast Turn Off Time
- Very Low Current Consumption/USB Compliant
- Li ion Battery Voltage Monitoring
- Overvoltage Lockout (OVLO)
- Undervoltage Lockout (UVLO)
- Overcurrent Protection Externally Adjustable (OCP) up to 2.8 A
- Thermal Shutdown
- Shutdown $\overline{\text{EN}}$ and Gain Input Pins
- Soft-Start to Eliminate Inrush Current
- Alert $\overline{\text{FLAG}}$ Output
- Compliance to IEC61000-4-2 (Level 4)
8 kV (Contact), 15 kV (Air)
- ESD Ratings: Machine Model = B
Human Body Model = 2
- 8 Lead DFN 2.2x2 mm Package
- These are Pb-Free Devices

Typical Application

- USB Devices
- Mobile Phones
- Peripheral
- Personal Digital Applications
- MP3 Players



ON Semiconductor®

<http://onsemi.com>

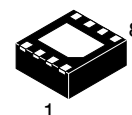

1
8
DFN8
MU SUFFIX
CASE 506BP

MARKING DIAGRAM

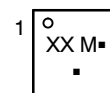

XX = Specific Device Code
M = Date Code
▪ = Pb-Free Device

(*Note: Microdot may be in either location)

PIN ASSIGNMENT

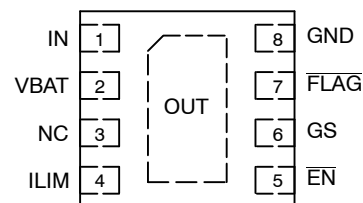

(Top View)

ORDERING INFORMATION

See detailed ordering, marking and shipping information in the package dimensions section on page 11 of this data sheet.

NCP367

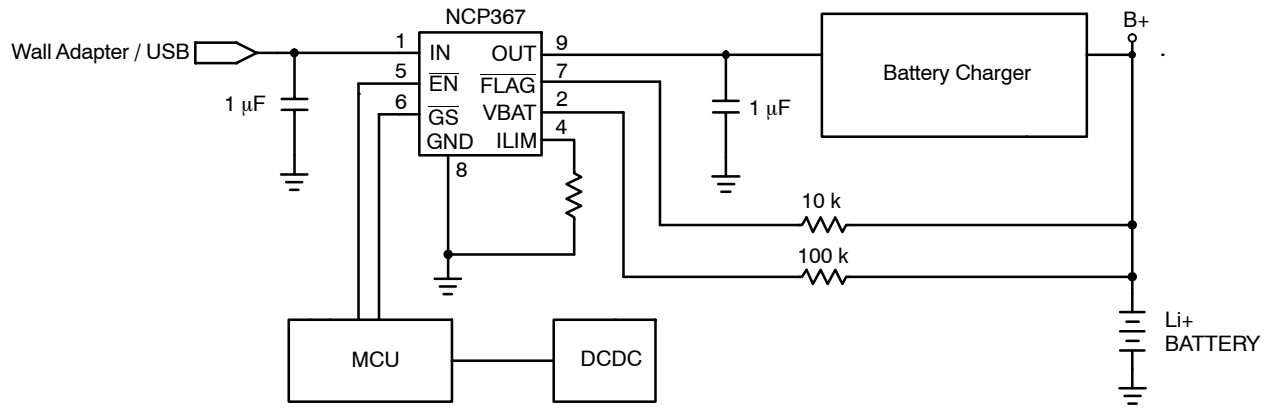

Figure 1. Typical Application Circuit

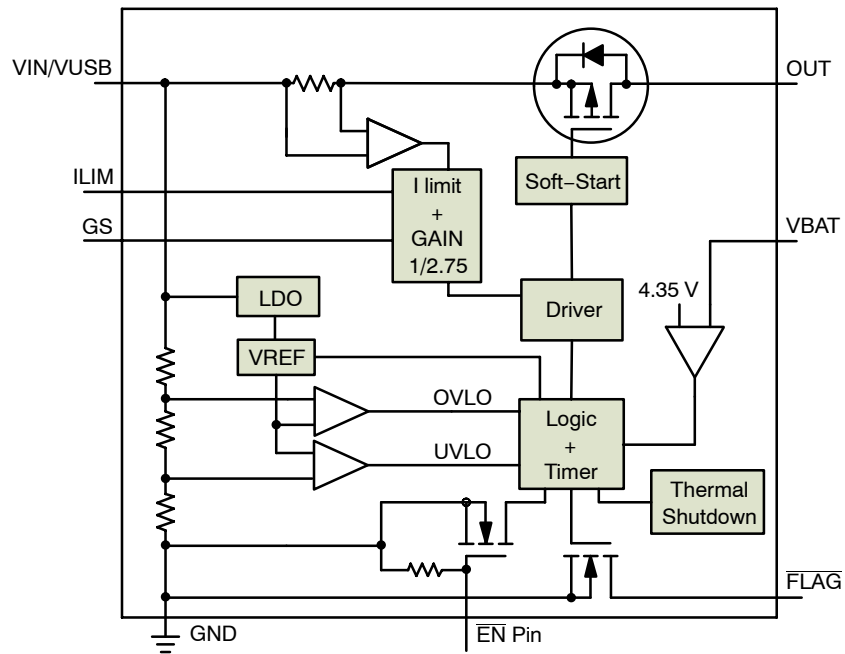

Figure 2. Functional Block Diagram

NCP367

PIN FUNCTION DESCRIPTION

Pin	Name	Type	Description
1	IN	POWER	Input Voltage Pin. This pin is connected to the power supply: Wall Adapter or USB. A 1 μ F low ESR ceramic capacitor, or larger, must be connected between this pin and GND.
2	V _{BAT}	INPUT	Li ion Battery voltage sense pin. A serial resistor must be placed between this pin and positive pin of the battery pack.
3	NC	OUTPUT	Not Connected
4	I _{LIM}	OUTPUT	Current Limit Pin. This pin provides the reference, based on the internal band-gap voltage reference, to limit the overcurrent, across internal PMOSFET, from IN to OUT. A 1% tolerance, or better, resistor shall be used to get the highest accuracy of the Overcurrent Limit.
5	$\overline{\text{EN}}$	INPUT	Enable Mode Pin. The device enters in shutdown mode when this pin is tied to a high level. In this case the output is disconnected from the input. The state of this pin does not have an impact on the fault detection of the FLAG pin.
6	GS	INPUT	Gain Select Pin. When the GS pin is tied to 0 level, the Overcurrent threshold is defined by I _{limit} -setting. See logic table. When GS pin is tied to high, the Overcurrent threshold is set to I _{limit} /GS
7	$\overline{\text{FLAG}}$	OUTPUT	Fault Indication Pin. This pin allows an external system to detect fault condition. The $\overline{\text{FLAG}}$ pin goes low when input voltage is below UVLO threshold, exceeds OVLO threshold, charge current from wall adapter to battery exceeds programmed current limit, Li ion Battery voltage (4.3 V) is exceeded or internal temperature exceeds thermal shutdown limit. Since the $\overline{\text{FLAG}}$ pin is open drain functionality, an external pull-up resistor to VBattery must be added (10 k Ω minimum value).
8	GND	POWER	Ground.
9	OUT	OUTPUT	Output Voltage Pin. This pin follows IN pin when "no input fault" is detected. The output is disconnected from the Vin power supply when voltage, current or thermal fault events are detected. A 1 μ F low ESR ceramic capacitor, or larger, must be connected between this pin and GND.

NOTE: Pin out provided for concept purpose only and might change in the final product

MAXIMUM RATINGS

Rating	Symbol	Value	Unit
Minimum Voltage (IN to GND)	V _{min} _{in}	-0.3	V
Minimum Voltage (All others to GND)	V _{min}	-0.3	V
Maximum Voltage (IN to GND)	V _{max} _{in}	30	V
Maximum Voltage (All others to GND)	V _{max}	7.0	V
Maximum DC Current from Vin to Vout (PMOS)	I _{max}	3.4	A
Thermal Resistance, Junction-to-Air (without PCB area)	R _{θJA}	190	°C/W
Operating Ambient Temperature Range	T _A	-40 to +85	°C
Storage Temperature Range	T _{stg}	-65 to +150	°C
Junction Operating Temperature	T _J	150	°C
ESD Withstand Voltage (IEC 61000-4-2) Human Body Model (HBM), Model = 2 (Note 1) Machine Model (MM) Model = B (Note 2)	V _{esd}	15 Air, 8.0 Contact 2000 200	kV V V
Latchup	LU	Class 1	-
Moisture Sensitivity	MSL	Level 1	-

Stresses exceeding Maximum Ratings may damage the device. Maximum Ratings are stress ratings only. Functional operation above the Recommended Operating Conditions is not implied. Extended exposure to stresses above the Recommended Operating Conditions may affect device reliability.

- Human Body Model, 100 pF discharged through a 1.5 k Ω resistor following specification JESD22/A114.
- Machine Model, 200 pF discharged through all pins following specification JESD22/A115.

NCP367

ELECTRICAL CHARACTERISTICS

(Min/Max limits values ($-40^{\circ}\text{C} < T_A < +85^{\circ}\text{C}$) and $V_{in} = +5.0\text{ V}$. Typical values are $T_A = +25^{\circ}\text{C}$, unless otherwise noted.)

Characteristic	Symbol	Conditions	Min	Typ	Max	Unit
Input Voltage Range	V_{in}		1.2		28	V
Undervoltage Lockout Threshold	UVLO	V_{in} falls down UVLO threshold	1.75	1.85	1.9	V
Undervoltage Lockout Hysteresis	UVLO _{hyst}			80	100	mV
Overvoltage Lockout Threshold NCP367OPMUEA NCP367DPMUEC NCP367DPMUEE NCP367DPMUEL NCP367OPMUEO	OVLO	V_{in} rises up OVLO threshold	3.65 5.64 5.85 6.60 6.90	3.8 5.85 6.07 6.84 7.20	3.95 6.05 6.28 7.08 7.50	V
Overvoltage Lockout Hysteresis	OVLO _{hyst}			100	150	mV
Vin versus Vout Resistance	$R_{DS(on)}$	$V_{in} = 5\text{ V}$, Enable Mode, Load Connected to V_{out}		50	100	m Ω
Supply Quiescent Current	I_{dd}	No Load		42	130	μA
Disable Mode	$I_{dd_{dis}}$	$\overline{\text{EN}} = 1.2\text{ V}$		40	110	μA
Overcurrent Threshold NCP367Dx NCP367Ox	I_{OCP}	$V_{in} = 5\text{ V}$, $\overline{\text{EN}} = \text{low}$, Load Connected to V_{out} , $R_{lim} = 0\text{ ohms}$, $1\text{ A}/\mu\text{s}$, $\overline{\text{GS}} = 0.4\text{ V}$	1.25 2.30	1.51 2.85	1.80 3.40	A
Overcurrent Response	I_{reg}	$1\text{ A}/\mu\text{s}$, $\overline{\text{GS}} = \text{low}$, $I_{lim} = 1.51\text{ A}$		5.0		%
Current Limit Gain NCP367D NCP367O	GS_{value}	$\overline{\text{GS}} = 1.2\text{ V}$		2.70 2.55		
Battery Overvoltage Threshold	OV _{BAT}	0°C to 85°C	4.3	4.35	4.4	V
Battery Overvoltage Hysteresis	OV _{HYS}	0°C to 85°C	100	150	200	mV
V _{BAT} Pin Leakage	VBAT _{LEAK}				20	nA
V _{BAT} Deglitch Time	VBAT _{DEG}	$V_{BAT} > \text{OV}_{BAT}$	0.2	2.0	4.0	ms
FLAG Output Low Voltage	$V_{ol_{flag}}$	$V_{in} > \text{OVLO}$ Sink 1 mA on FLAG pin			400	mV
FLAG Leakage Current	FLAG _{leak}	FLAG level = 5 V		10		nA
$\overline{\text{EN}}$ Voltage High	V_{ih}	V_{in} from 3.3 V to 5.25 V	1.2			V
$\overline{\text{EN}}$ Voltage Low	V_{il}	V_{in} from 3.3 V to 5.25 V			0.4	V
EN Leakage Current	$\overline{\text{EN}}_{leak}$	$\overline{\text{EN}} = 5.5\text{ V}$ or GND		200		nA
$\overline{\text{GS}}$ Voltage High	V_{ih}	V_{in} from 3.3 V to 5.25 V	1.2			V
$\overline{\text{GS}}$ Voltage Low	V_{il}	V_{in} from 3.3 V to 5.25 V			0.4	V
$\overline{\text{GS}}$ Leakage Current	$\overline{\text{GS}}_{leak}$	$\overline{\text{EN}} = 5.5\text{ V}$ or GND		200		nA

TIMINGS

Start Up Delay	t_{on}	From $V_{in} > \text{UVLO}$ to $V_{out} = 0.8 \times V_{in}$	15	30	45	ms
FLAG going up Delay	t_{start}	From $V_{out} > 0.2 \times V_{in}$ to $\overline{\text{FLAG}} = 1.2\text{ V}$	15	30	45	ms
Rearming Delay	t_{REARM}	OCP Active	15	30	45	ms
Overcurrent Regulation Time	t_{REG}	OCP Active	1.2	1.8	3.0	ms
Output Turn Off Time	t_{off}	From $V_{in} > \text{OVLO}$ to $V_{out} \leq 0.3\text{ V}$, V_{in} increasing from 5 V to 8 V at 3 V/ μs .		1.5	5.0	μs
Alert Delay	t_{stop}	From $V_{in} > \text{OVLO}$ to $\overline{\text{FLAG}} \leq 0.4\text{ V}$, (see Figure 15) V_{in} increasing from 5 V to 8 V at 3 V/ μs		1.5		μs
Disable Time	t_{dis}	From $\overline{\text{EN}} 0.4$ to 1.2 V to $V_{out} \leq 0.3\text{ V}$		3.0		μs

NCP367

Characteristic	Symbol	Conditions	Min	Typ	Max	Unit
TIMINGS						
Thermal Shutdown Temperature	T_{sd}			150		°C
Thermal Shutdown Hysteresis	$T_{sd_{hyst}}$			30		°C

NOTE: Electrical parameters are guaranteed by correlation across the full range of temperature.

TYPICAL OPERATING CHARACTERISTICS

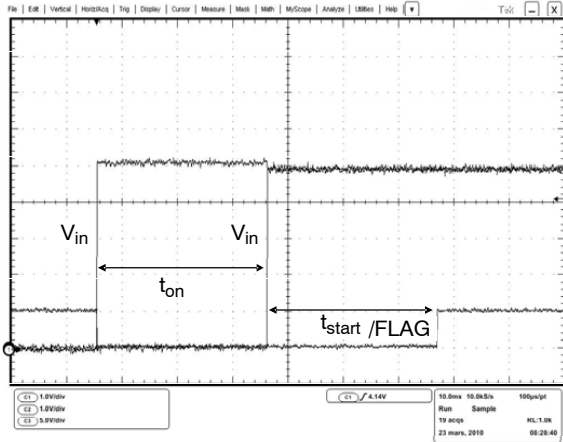

Figure 3. Hot Plug-in from 0 to 5 V, t_{on} and t_{start}

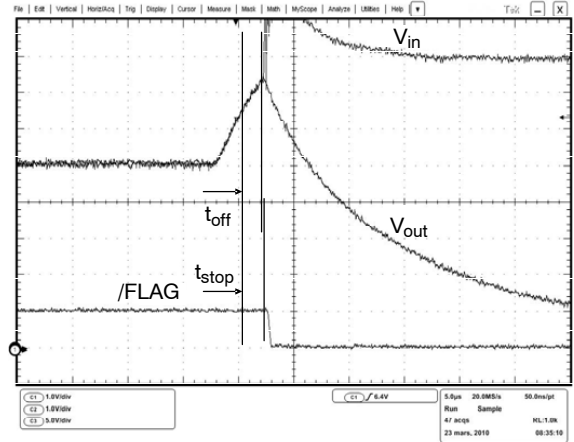

Figure 4. Overvoltage from 5 to 8 V, t_{off} and t_{stop}

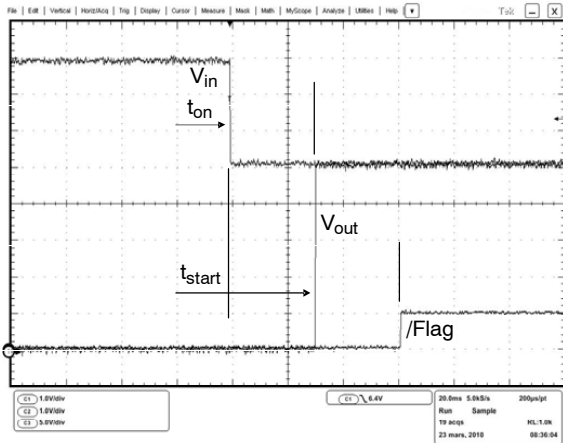

Figure 5. Retrieve Normal Operation, t_{on} and t_{start}

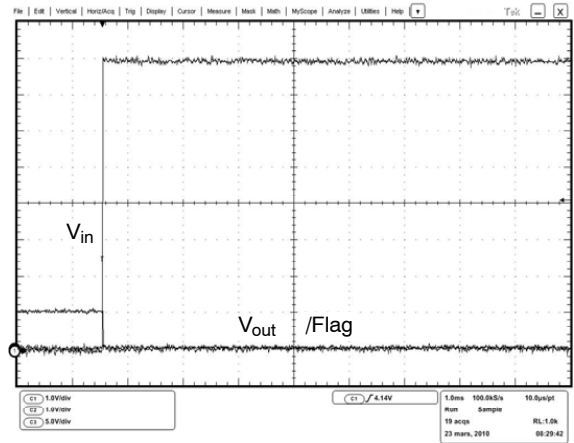

Figure 6. Overvoltage from 0 to 10 V

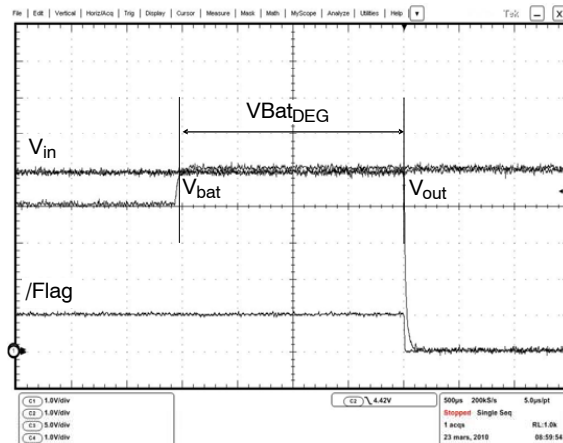

Figure 7. Battery Overvoltage, Deglitch Time

TYPICAL OPERATING CHARACTERISTICS

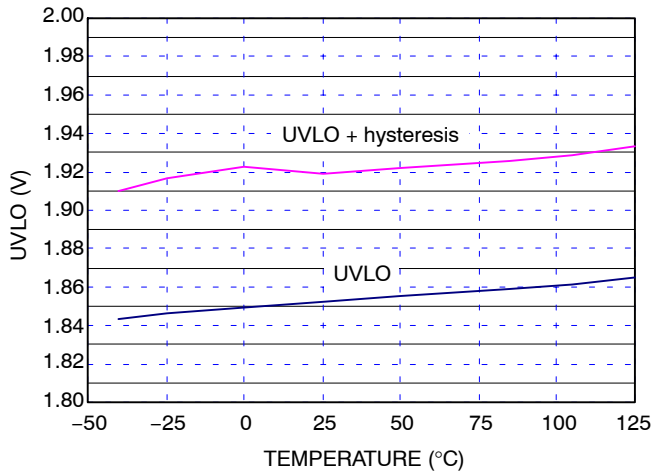

Figure 8. UVLO and Hysteresis

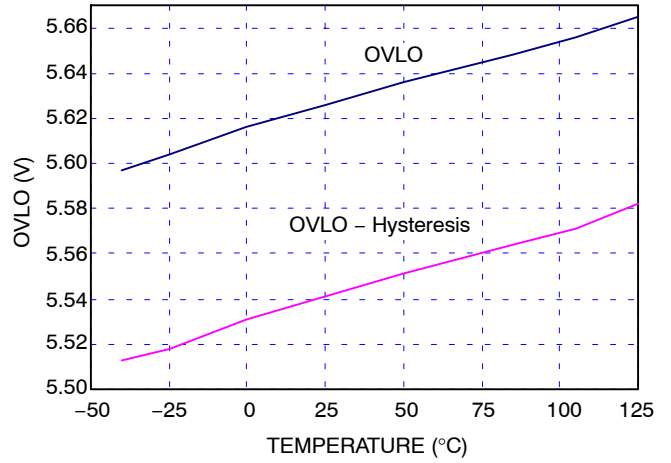

Figure 9. OVLO and Hysteresis vs. Temperature (5.6 V version)

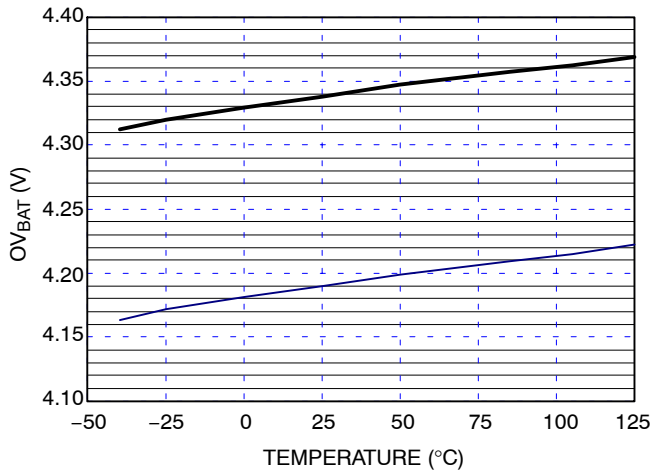

Figure 10. V_{BAT} Threshold and Hysteresis vs. Temperature

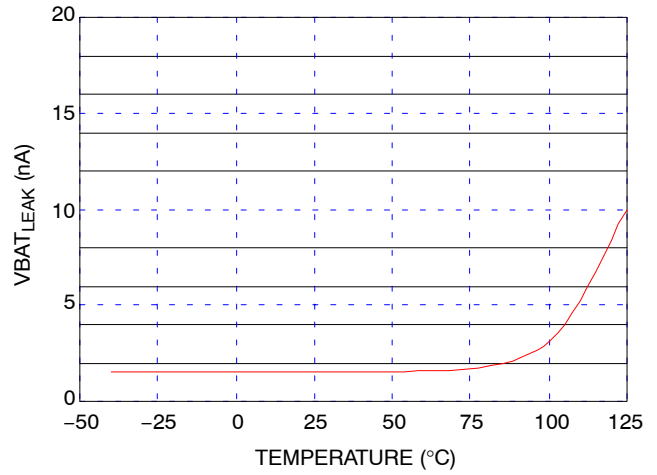

Figure 11. V_{BAT} Pin Leakage vs. Temperature

APPLICATION INFORMATION

Operation

The NCP367 is an integrated IC which offers a complete protection of the portable devices during the Li ion battery charge.

First, the input pin is protected up to +30 V, protecting the down stream system (charger, transceiver, system...) against the power supply transients such as inrush current or defective functionality. Additional protection level is offered with the overcurrent block which eliminates current peak or opens the charge path if an overcurrent default appears.

More of that, the battery voltage is monitored all along the input power supply is connected, allowing to open charge path if Li ion battery voltage exceeds 4.3 V, caused by CCCV charger or battery pack fault.

The integrated pass element (PMOS FET) is sized to support very high charge DC current up to 2.3 A. The overcurrent threshold can be externally adjusted with a pull-down resistor and gain select pin is available to divide current limit threshold with internal fixed gain. Allowing to adjust with logic pin the overcurrent threshold if USB/500 mA or WA/1.5 A is detected, without changing R_{ILIM} resistor, in example.

Undervoltage, Overvoltage, Overcurrent and thermal faults are signalized thanks to the open drain FLAG pin, by pulling its down.

Undervoltage Lockout (UVLO)

To ensure proper operation under any conditions, the device has a built-in undervoltage lock out (UVLO) circuit. During V_{in} positive going slope, the output remains disconnected from input until V_{in} voltage is above 1.85 V plus hysteresis nominal. This circuit has a 80 mV hysteresis to provide noise immunity to transient condition.

Overvoltage Lockout (OVLO)

To protect connected systems on V_{out} pin from overvoltage, the device has a built-in overvoltage lock out (OVLO) circuit. During overvoltage condition, the output remains disabled as long as the input voltage exceeds this threshold.

\overline{FLAG} output is tied to low as long as V_{in} is higher than OVLO. This circuit has a 100 mV hysteresis to provide noise immunity to transient conditions.

FLAG Output

NCP367 provides a \overline{FLAG} output, which alerts external systems that a fault has occurred.

This pin is tied to low as soon as the OVLO, OV_{BAT} , I_{OCP} or internal temperature thresholds are exceeded and remains low until between minimum driving voltage and UVLO threshold. When V_{in} level recovers normal condition, \overline{FLAG} is held high. The pin is an open drain output, thus a pull up resistor (typically 1 M Ω – Minimum 10 k Ω) must be provided to V_{cc} . FLAG pin is an open drain output, which is able to support 1 mA maximum.

 \overline{EN} Input

To enable normal operation, the \overline{EN} pin shall be forced to low or connected to ground. A high level on the pin, disconnects OUT pin from IN pin. \overline{EN} does not overdrive a UVLO or OVLO fault.

Overcurrent Protection (OCP)

This device integrates the overcurrent protection function, from wall adapter to battery. That means the current across the internal PMOS is regulated and cut when the value, set by external RSEL resistor, exceeds I_{LIM} longer than t_{REG} .

An internal resistor is placed in series with the pin allowing to have a maximum OCP value when I_{LIM} pin is directly connected to GND.

By adding external resistors in series with I_{LIM} and GND, the OCP value is decreased.

An additional logic pin, \overline{GS} (gain select), is very useful in case of different charge rate is necessary (Wall adapter and USB, for example).

By setting \overline{GS} to 0.4 V, overcurrent thresholds are depending on R select resistor, which is connect between pin 4 and GND. When the \overline{GS} pin is tied to 1.2 V (high logic level) the preselected current limit is divided by 2.75.

Thanks to this option, both fast charge or USB charge are authorized with the same device.

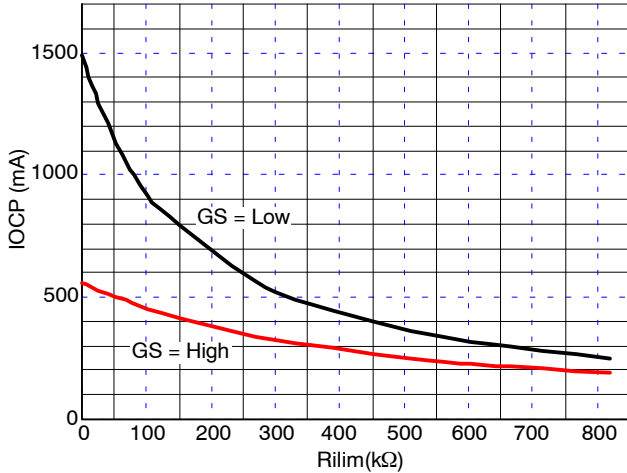

Figure 12. I_{OCP} versus R_{LIM}, GS = low and high, 1.5 A version

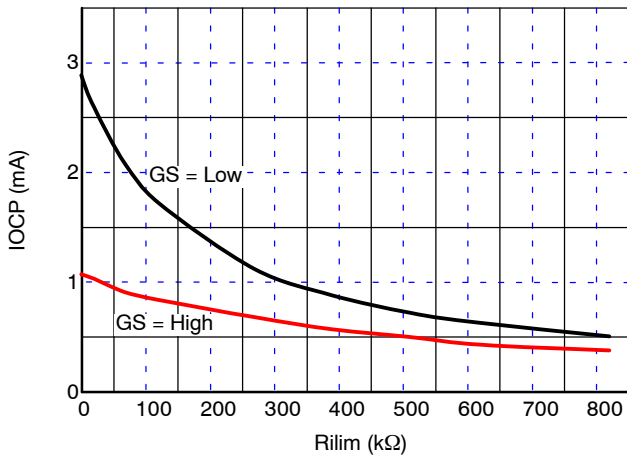

Figure 13. Over Current Threshold versus R_{LIMIT} 2.85 A Version

Typical R_{LIM} calculation is following:
NCP367DxMUxxTBG

$$R_{LIM} (k\Omega) = 249 / I_{OCP} - 165$$

NCP367OxMUxxTBG

$$R_{LIM} (k\Omega) = 532 / I_{OCP} - 180$$

During overcurrent event, charge area is opened and FLAG output is tied to low, allowing the μController to take into account the fault event and then open the charge path.

At power up (accessory is plugged on input pins), the current is limited up to I_{LIM} during 1.8 ms (typical), to allow capacitor charge and limit inrush current. If the I_{LIM} threshold is exceeded over 1.8 ms, the device enter in OCP burst mode until the overcurrent event disappears.

V_{BAT} Sense

The connection of the V_{BAT} pin to the positive connection of the Li ion battery pack allows preventing overvoltage transient, greater than 4.35 V. In case of wrong charger conditions, the PMOS is then opened, eliminating Battery pack over voltage which could create safety issues and temperature increasing.

The 4.35 V comparator has a 150 mV built-in hysteresis.

More of that, deglitch function of 2 ms is integrated to prevent voltage transients on the Battery voltage. If the battery over voltage condition exceeds deglitch time, the charge path is opened and FLAG pin is tied to low level until the V_{BAT} is greater than 4.35 V – hysteresis.

At wall adapter insertion, and if the battery is fully charged, V_{bat} comparator stays locked until battery needs to be recharged (4.2 V typ – 4.1 V min).

A serial resistor has to be placed in series with Vbat pin and battery connection, with a 200 kΩ recommended value.

PCB Recommendations

The NCP367 integrates low R_{DS(on)} PMOS FET, nevertheless PCB layout rules must be respected to properly evacuate the heat out of the silicon. The DFN PAD1 corresponds to the PMOS drain so must be connected to OUT plane to increase the heat transfer. Of course, in any case, this pad shall be not connected to any other potential.

Following figure shows package thermal resistance of a DFN 2.2x2 mm.

NCP367

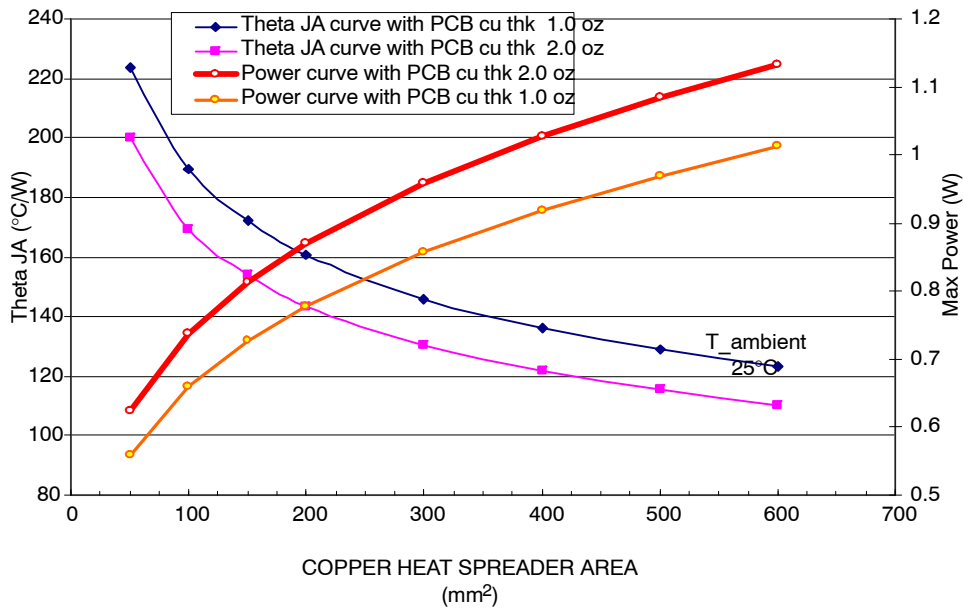

Internal PMOS FET

NCP367 includes an internal PMOS FET to protect the systems, connected on OUT pin, from positive over-voltage. Regarding electrical characteristics, the $R_{DS(on)}$, during normal operation, will create low losses on V_{out} pin versus V_{in} , thanks to very low $R_{DS(on)}$.

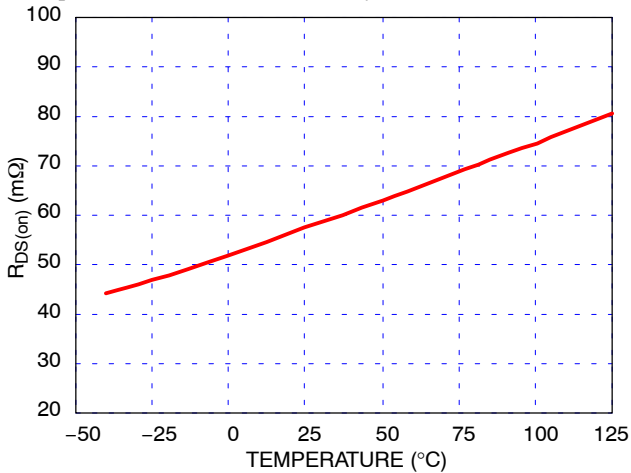

Figure 14. Typical $R_{DS(on)}$ versus Temperature

ESD Tests

NCP367 fully support the IEC61000-4-2, level 4 (Input pin, 1 μ F mounted on board). That means, in Air condition, V_{in} has a ± 15 kV ESD protected input. In Contact condition, V_{in} has ± 8 kV ESD protected input. Please refer to Figure 15 to see the IEC 61000-4-2 electrostatic discharge waveform.

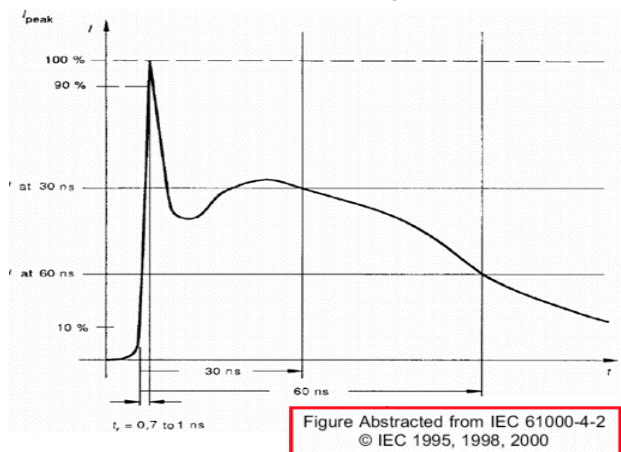

Figure 15. IEC 61000-4-2 Electrostatic Discharge

NCP367

ORDERING INFORMATION

Device	Marking	Package	Shipping†
NCP367DPMUECTBG	DC	DFN8 (Pb-Free)	3000 / Tape & Reel
NCP367DPMUEETBG	DE	DFN8 (Pb-Free)	3000 / Tape & Reel
NCP367DPMUELTBG	DL	DFN8 (Pb-Free)	3000 / Tape & Reel
NCP367OPMUEOTBG	P3	DFN8 (Pb-Free)	3000 / Tape & Reel
NCP367OPMUEATBG	EA	DFN8 (Pb-Free)	3000 / Tape & Reel

†For information on tape and reel specifications, including part orientation and tape sizes, please refer to our Tape and Reel Packaging Specifications Brochure, BRD8011/D.

SELECTION GUIDE

The NCP367 can be available in several undervoltage and overvoltage thresholds versions. Part number is designated as follows:

NCP367xxMUxxTBG

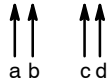

Code	Contents
a	Overcurrent threshold a = D: 1.51 A a = O: 2.85 A
b	V _{BAT} Voltage b: P = 4.36 V (additional thresholds available for a wide Lithium ion material range)
c	UVLO Typical Threshold c: E = 1.85 V
d	OVLO Typical Threshold (Additional thresholds available) d: C = 5.85 V d: E = 6.07 V d: L = 6.85 V d: O = 7.20 V d: A = 3.80 V

NCP367

PACKAGE DIMENSIONS

DFN8, 2.0x2.2, 0.5P CASE 506BP ISSUE A

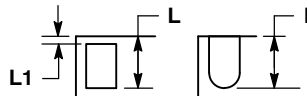
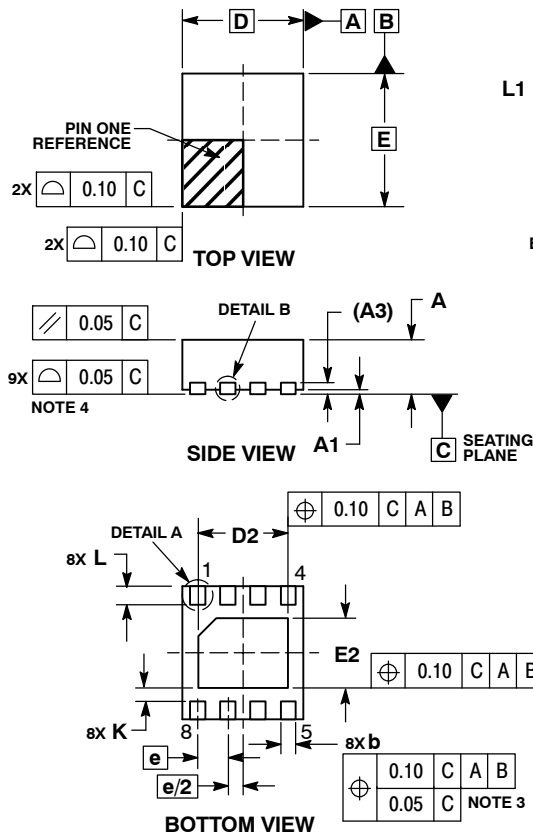

DETAIL A
ALTERNATE TERMINAL
CONSTRUCTIONS

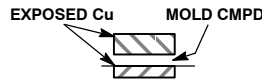

DETAIL B
ALTERNATE
CONSTRUCTIONS

NOTES:

1. DIMENSIONING AND TOLERANCING PER ASME Y14.5M, 1994.
2. CONTROLLING DIMENSION: MILLIMETERS.
3. DIMENSION b APPLIES TO PLATED TERMINAL AND IS MEASURED BETWEEN 0.15 AND 0.30 mm FROM TERMINAL.
4. COPLANARITY APPLIES TO THE EXPOSED PAD AS WELL AS THE TERMINALS.

DIM	MILLIMETERS		
	MIN	TYP	MAX
A	0.80	---	1.00
A1	0.00	---	0.05
A3	0.20 REF		
b	0.20	---	0.30
D	2.00 BSC		
D2	1.43	---	1.53
E	2.20 BSC		
E2	1.05	---	1.25
e	0.50 BSC		
K	0.20	0.22	0.30
L	0.25	---	0.35
L1	---	---	0.15

SOLDERING FOOTPRINT*

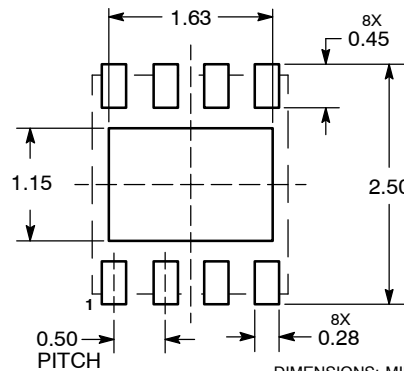

DIMENSIONS: MILLIMETERS

*For additional information on our Pb-Free strategy and soldering details, please download the ON Semiconductor Soldering and Mounting Techniques Reference Manual, SOLDERRM/D.

ON Semiconductor and are registered trademarks of Semiconductor Components Industries, LLC (SCILLC). SCILLC owns the rights to a number of patents, trademarks, copyrights, trade secrets, and other intellectual property. A listing of SCILLC's product/patent coverage may be accessed at www.onsemi.com/site/pdf/Patent-Marking.pdf. SCILLC reserves the right to make changes without further notice to any products herein. SCILLC makes no warranty, representation or guarantee regarding the suitability of its products for any particular purpose, nor does SCILLC assume any liability arising out of the application or use of any product or circuit, and specifically disclaims any and all liability, including without limitation special, consequential or incidental damages. "Typical" parameters which may be provided in SCILLC data sheets and/or specifications can and do vary in different applications and actual performance may vary over time. All operating parameters, including "Typicals" must be validated for each customer application by customer's technical experts. SCILLC does not convey any license under its patent rights nor the rights of others. SCILLC products are not designed, intended, or authorized for use as components in systems intended for surgical implant into the body, or other applications intended to support or sustain life, or for any other application in which the failure of the SCILLC product could create a situation where personal injury or death may occur. Should Buyer purchase or use SCILLC products for any such unintended or unauthorized application, Buyer shall indemnify and hold SCILLC and its officers, employees, subsidiaries, affiliates, and distributors harmless against all claims, costs, damages, and expenses, and reasonable attorney fees arising out of, directly or indirectly, any claim of personal injury or death associated with such unintended or unauthorized use, even if such claim alleges that SCILLC was negligent regarding the design or manufacture of the part. SCILLC is an Equal Opportunity/Affirmative Action Employer. This literature is subject to all applicable copyright laws and is not for resale in any manner.

PUBLICATION ORDERING INFORMATION

LITERATURE FULFILLMENT:
Literature Distribution Center for ON Semiconductor
P.O. Box 5163, Denver, Colorado 80217 USA
Phone: 303-675-2175 or 800-344-3860 Toll Free USA/Canada
Fax: 303-675-2176 or 800-344-3867 Toll Free USA/Canada
Email: orderlit@onsemi.com

N. American Technical Support: 800-282-9855 Toll Free
USA/Canada
Europe, Middle East and Africa Technical Support:
Phone: 421 33 790 2910
Japan Customer Focus Center
Phone: 81-3-5817-1050

ON Semiconductor Website: www.onsemi.com
Order Literature: <http://www.onsemi.com/orderlit>

For additional information, please contact your local Sales Representative

Компания «Life Electronics» занимается поставками электронных компонентов импортного и отечественного производства от производителей и со складов крупных дистрибьюторов Европы, Америки и Азии.

С конца 2013 года компания активно расширяет линейку поставок компонентов по направлению коаксиальный кабель, кварцевые генераторы и конденсаторы (керамические, пленочные, электролитические), за счёт заключения дистрибьюторских договоров

Мы предлагаем:

- Конкуренеспособные цены и скидки постоянным клиентам.
- Специальные условия для постоянных клиентов.
- Подбор аналогов.
- Поставку компонентов в любых объемах, удовлетворяющих вашим потребностям.
- Приемлемые сроки поставки, возможна ускоренная поставка.
- Доставку товара в любую точку России и стран СНГ.
- Комплексную поставку.
- Работу по проектам и поставку образцов.
- Формирование склада под заказчика.
- Сертификаты соответствия на поставляемую продукцию (по желанию клиента).
- Тестирование поставляемой продукции.
- Поставку компонентов, требующих военную и космическую приемку.
- Входной контроль качества.
- Наличие сертификата ISO.

В составе нашей компании организован Конструкторский отдел, призванный помогать разработчикам, и инженерам.

Конструкторский отдел помогает осуществить:

- Регистрацию проекта у производителя компонентов.
- Техническую поддержку проекта.
- Защиту от снятия компонента с производства.
- Оценку стоимости проекта по компонентам.
- Изготовление тестовой платы монтаж и пусконаладочные работы.



Тел: +7 (812) 336 43 04 (многоканальный)

Email: org@lifeelectronics.ru