



# 3 V SUPER MINIMOLD L-BAND SI MMIC DOWNCONVERTER

## UPC2756TB

### FEATURES

- **HIGH DENSITY SURFACE MOUNTING:**  
6 Pin Super Minimold or SOT-363 package
- **WIDE BAND OPERATION:**  
RF = 0.1 to 2.0 GHz  
IF = 10 to 300 MHz
- **ON BOARD OSCILLATOR**
- **SUPPLY VOLTAGE:**  
Vcc = 2.7 TO 3.3 V

### DESCRIPTION

NEC's UPC2756TB is a silicon MMIC integrated circuit manufactured using the NESAT III process. The device consists of a double balance mixer, an IF amplifier and a built-in LO. This device is suitable as a L-BAND downconverter for the receiver stage of wireless systems. The UPC2756TB is pin compatible and has comparable performance as the larger UPC2756T, so it is suitable for use as a replacement to help reduce system size. The IC housed in a 6 pin super minimold or SOT-363 package.

NEC's stringent quality assurance and test procedures ensure the highest reliability and performance.

### INTERNAL BLOCK DIAGRAM

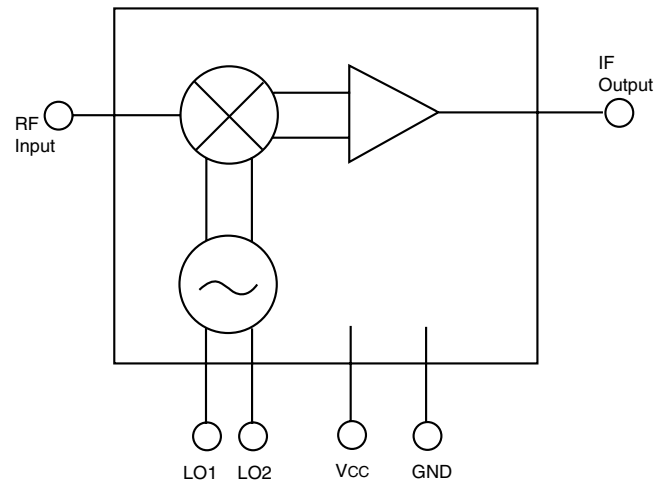

### ELECTRICAL CHARACTERISTICS (T<sub>A</sub> = 25°C, V<sub>cc</sub> = 3 V, Z<sub>L</sub> = Z<sub>s</sub> = 50 Ω)

PART NUMBER PACKAGE OUTLINE		UPC2756TB S06			
SYMBOLS	PARAMETERS AND CONDITIONS	UNITS	MIN	TYP	MAX
I <sub>CC</sub>	Circuit Current (no signal)	mA	3.5	6.0	8.0
f <sub>RF</sub>	RF Frequency Response (3 dB down from the gain at f <sub>RF</sub> = 900 MHz, f <sub>IF</sub> = 150 MHz)	GHz	0.1		2.0
f <sub>IF</sub>	IF Frequency Response (3 dB down from the gain at f <sub>RF</sub> = 900 MHz, f <sub>IF</sub> = 150 MHz)	MHz	10	300	
CG	Conversion Gain <sup>1</sup> f <sub>RF</sub> = 900 MHz, f <sub>IF</sub> = 150 MHz f <sub>RF</sub> = 1.6 GHz, f <sub>IF</sub> = 20 MHz	dB dB	11 11	14 14	17 17
NF	Noise Figure f <sub>RF</sub> = 900 MHz, f <sub>IF</sub> = 150 MHz f <sub>RF</sub> = 1.6 GHz, f <sub>IF</sub> = 20 MHz	dB dB		10 13	13 16
PSAT	Saturated Output Power <sup>2</sup> f <sub>RF</sub> = 900 MHz, f <sub>IF</sub> = 150 MHz f <sub>RF</sub> = 1.6 GHz, f <sub>IF</sub> = 20 MHz	dBm dBm	-11 -15	-8 -12	
OIP <sub>3</sub>	SSB Output 3rd Order Intercept Point f <sub>RF</sub> = 0.8~2.0 GHz, f <sub>IF</sub> = 100 MHz	dBm		+4	
ISO	LO Leakage, f <sub>LO</sub> = 0.8~2.0 GHz at RF pin at IF pin	dBm dBm		-35 -23	
PN	Phase Noise <sup>3</sup> , f <sub>osc</sub> = 1.9 GHz	dBc/Hz		-68	
R <sub>TH</sub> (J-A)	Thermal Resistance (Junction to Ambient) Mounted on a 50 x 50 x 1.6 mm epoxy glass PWB	°C/W			325

Notes:

1. P<sub>RF</sub> = -40 dBm.
2. P<sub>RF</sub> = -10 dBm.
3. See Application Circuit.

**ABSOLUTE MAXIMUM RATINGS<sup>1</sup>** (T<sub>A</sub> = 25°C)

SYMBOLS	PARAMETERS	UNITS	RATINGS
V <sub>CC</sub>	Supply Voltage	V	5.5
P <sub>T</sub>	Total Power Dissipation <sup>2</sup>	mW	200
T <sub>OP</sub>	Operating Temperature	°C	-40 to +85
T <sub>STG</sub>	Storage Temperature	°C	-55 to +150

Notes:

1. Operation in excess of any one of these parameters may result in permanent damage.
2. Mounted on a 50 x 50 x 1.6 mm epoxy glass PWB (T<sub>A</sub> = +85°C).

**RECOMMENDED OPERATING CONDITIONS**

SYMBOLS	PARAMETERS	UNITS	MIN	TYP	MAX
V <sub>CC</sub>	Supply Voltage	V	2.7	3.0	3.3
T <sub>OP</sub>	Operating Temperature	°C	-40	+25	+85

**TEST CIRCUIT**

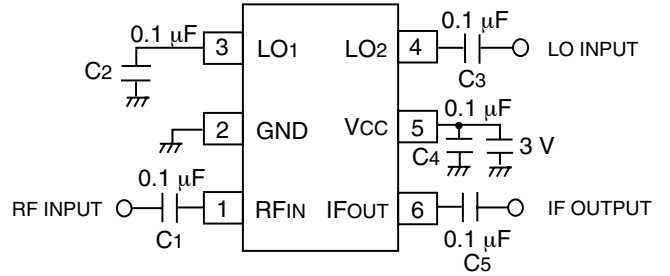

**PIN FUNCTIONS**

Pin No.	Symbol	Applied Voltage (V)	Pin Voltage (V)	Description	Internal Equivalent Circuit
1	RFIN	–	1.2	Signal input pin to double balanced mixer. This pin must be coupled to the signal source with a blocking capacitor.	
2	GND	0	–	Ground pin. This pin should be connected to system ground with minimum inductance. Ground pattern on the board should be formed as wide as possible.	
3	LO1	–	1.2	These pins are both the base-collectors of a differential amplifier configured to oscillate when equipped with an external tank resonator circuit. Each pin must be coupled to the tank circuit with a blocking capacitor. In the case of an external LO source, bypass the unused pin with a capacitor to ground.	
4	LO2	–	1.2		
5	VCC	2.7 to 3.3	–	Power supply pin. This pin should be externally equipped with a bypass capacitor to minimize ground impedance.	
6	IFOUT	–	1.7	Output of single-ended push-pull IF buffer amplifier. This is an emitter-follower output with low impedance. This pin must be coupled to the next stage with a blocking capacitor.	

TYPICAL PERFORMANCE CURVES (TA = 25°C)

CIRCUIT CURRENT vs. VOLTAGE

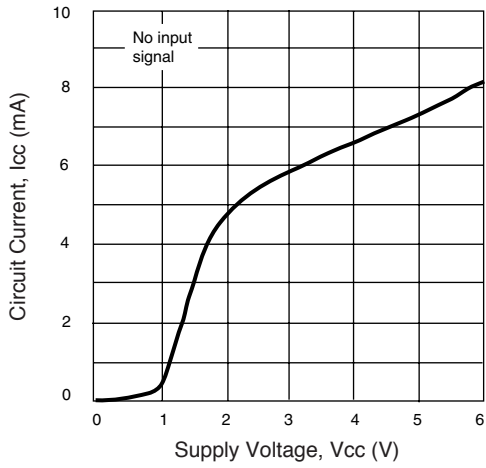

CIRCUIT CURRENT vs. TEMPERATURE

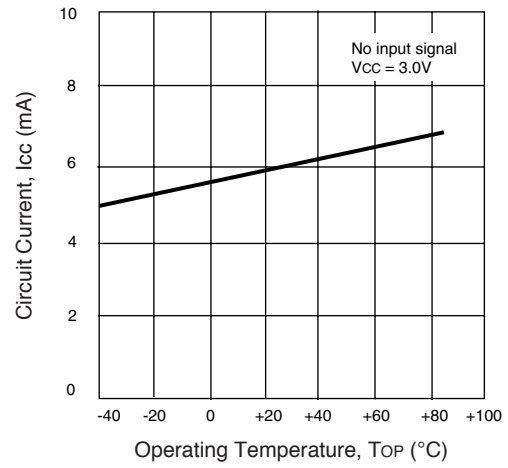

CONVERSION GAIN AND NOISE FIGURE vs. RF INPUT FREQUENCY

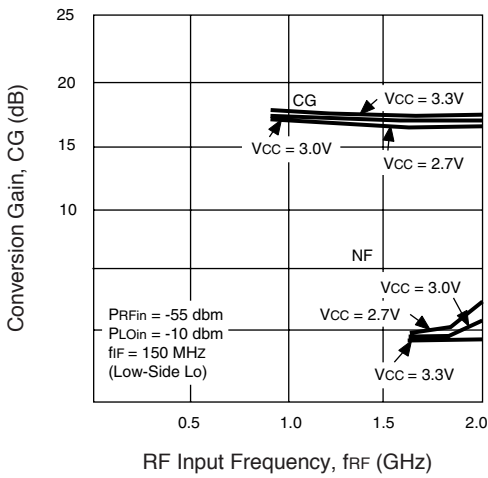

CONVERSION GAIN vs. IF OUTPUT FREQUENCY

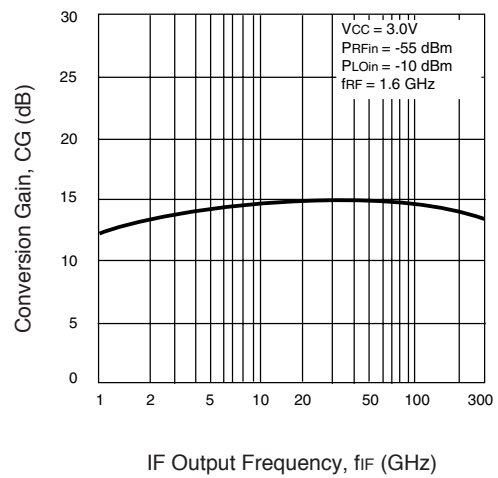

LO LEAKAGE AT RF PIN vs. LO FREQUENCY

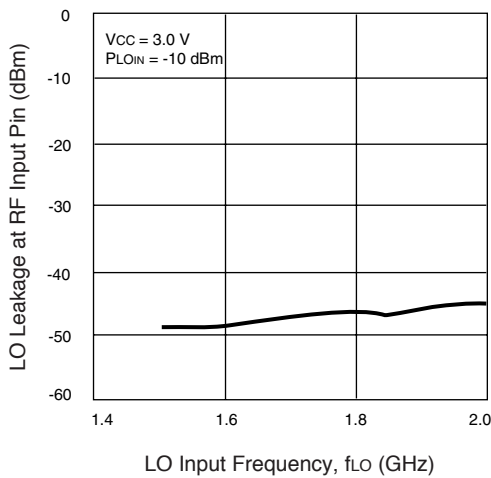

LO LEAKAGE AT IF PIN vs. LO FREQUENCY

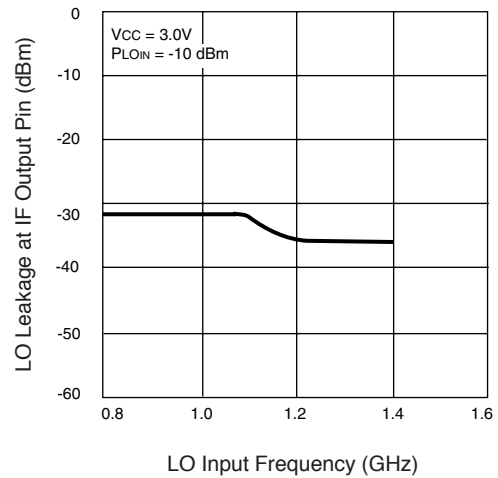

TYPICAL PERFORMANCE CURVES (TA = 25°C)

IF OUTPUT LEVEL AND IM3 vs. RF INPUT LEVEL

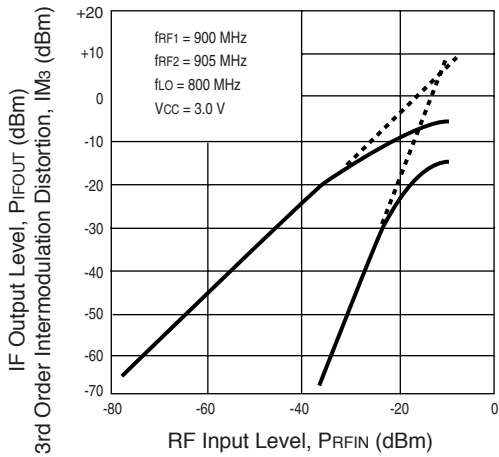

IF OUTPUT LEVEL AND IM3 vs. RF INPUT LEVEL

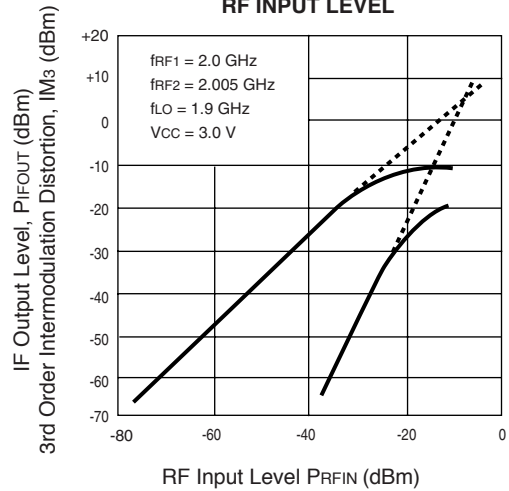

VCO OSCILLATION FREQUENCY vs. TUNING VOLTAGE

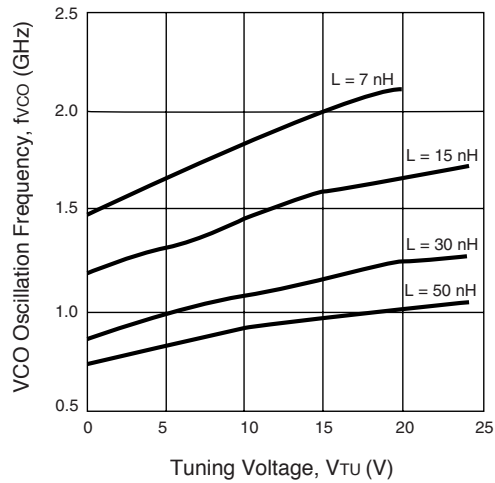

VCO PHASE NOISE

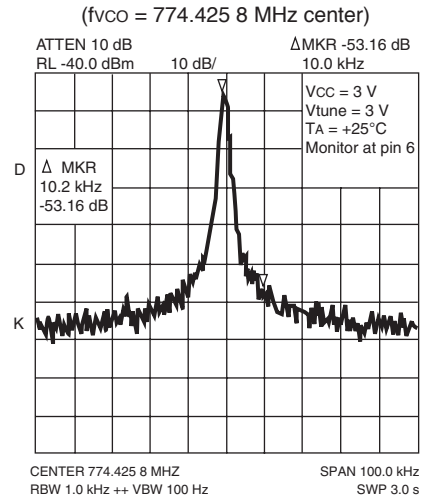

VCO PHASE NOISE

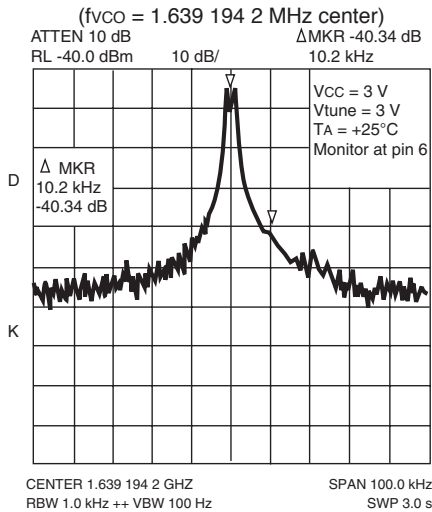

TYPICAL SCATTERING PARAMETERS

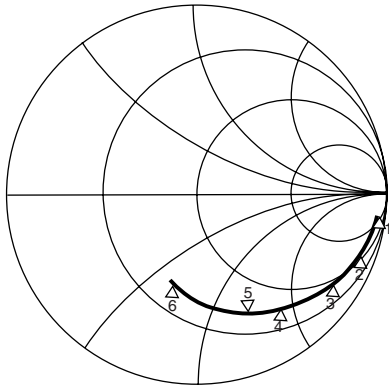

RF Port  
Vcc = 3.0 V  
Start 0.10 GHz  
Stop 3.10 GHz

1:	100 MHz	519.8 Ω	-j 1.1 Ω
2:	500 MHz	59.3 Ω	-j 281.0 Ω
3:	900 MHz	38.3 Ω	-j 157.0 Ω
4:	1500 MHz	31.5 Ω	-j 90.1 Ω
5:	1900 MHz	28.5 Ω	-j 67.9 Ω
6:	3000 MHz	25.7 Ω	-j 31.7 Ω

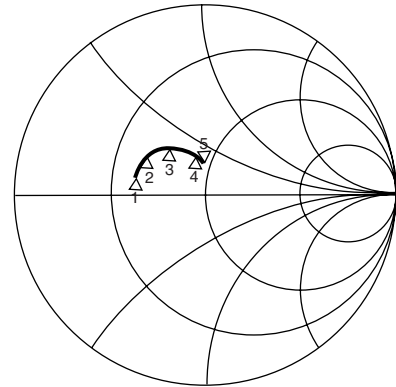

RF Port  
Vcc = 3.0 V  
Start 0.05 GHz  
Stop 3.00 GHz

1:	50 MHz	22.5 Ω	+j 6.1 Ω
2:	80 MHz	24.2 Ω	+j 11.3 Ω
3:	130 MHz	30.2 Ω	+j 16.6 Ω
4:	240 MHz	42.6 Ω	+j 17.5 Ω
5:	300 MHz	46.6 Ω	+j 15.6 Ω

SYSTEM APPLICATION EXAMPLE

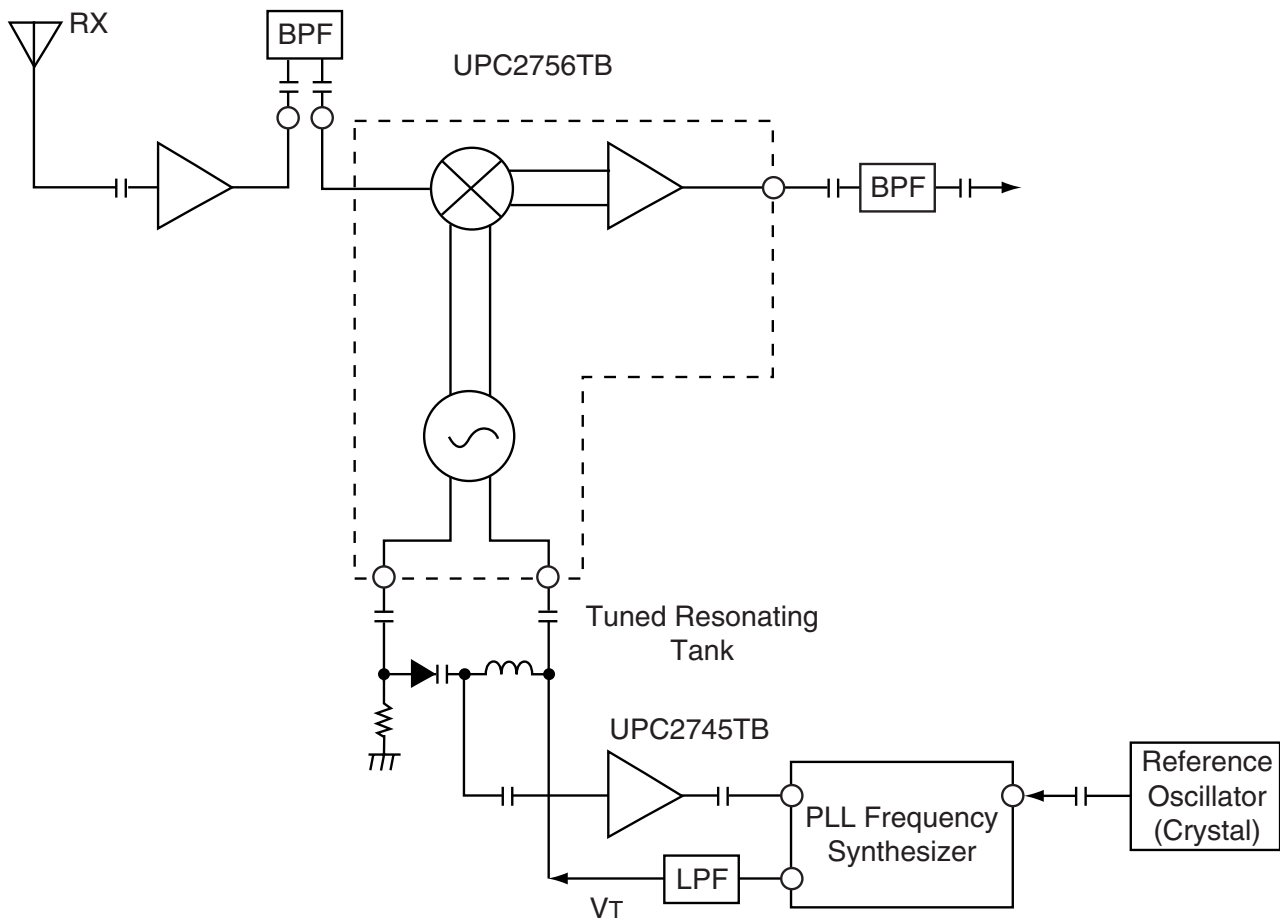



Subject: Compliance with EU Directives

CEL certifies, to its knowledge, that semiconductor and laser products detailed below are compliant with the requirements of European Union (EU) Directive 2002/95/EC Restriction on Use of Hazardous Substances in electrical and electronic equipment (RoHS) and the requirements of EU Directive 2003/11/EC Restriction on Penta and Octa BDE.

CEL Pb-free products have the same base part number with a suffix added. The suffix –A indicates that the device is Pb-free. The –AZ suffix is used to designate devices containing Pb which are exempted from the requirement of RoHS directive (\*). In all cases the devices have Pb-free terminals. All devices with these suffixes meet the requirements of the RoHS directive.

This status is based on CEL’s understanding of the EU Directives and knowledge of the materials that go into its products as of the date of disclosure of this information.

Restricted Substance per RoHS	Concentration Limit per RoHS (values are not yet fixed)	Concentration contained in CEL devices	
		-A	-AZ
Lead (Pb)	< 1000 PPM	Not Detected	(*)
Mercury	< 1000 PPM	Not Detected	
Cadmium	< 100 PPM	Not Detected	
Hexavalent Chromium	< 1000 PPM	Not Detected	
PBB	< 1000 PPM	Not Detected	
PBDE	< 1000 PPM	Not Detected	

If you should have any additional questions regarding our devices and compliance to environmental standards, please do not hesitate to contact your local representative.

Important Information and Disclaimer: Information provided by CEL on its website or in other communications concerning the substance content of its products represents knowledge and belief as of the date that it is provided. CEL bases its knowledge and belief on information provided by third parties and makes no representation or warranty as to the accuracy of such information. Efforts are underway to better integrate information from third parties. CEL has taken and continues to take reasonable steps to provide representative and accurate information but may not have conducted destructive testing or chemical analysis on incoming materials and chemicals. CEL and CEL suppliers consider certain information to be proprietary, and thus CAS numbers and other limited information may not be available for release.

In no event shall CEL’s liability arising out of such information exceed the total purchase price of the CEL part(s) at issue sold by CEL to customer on an annual basis.

See CEL Terms and Conditions for additional clarification of warranties and liability.

Компания «Life Electronics» занимается поставками электронных компонентов импортного и отечественного производства от производителей и со складов крупных дистрибьюторов Европы, Америки и Азии.

С конца 2013 года компания активно расширяет линейку поставок компонентов по направлению коаксиальный кабель, кварцевые генераторы и конденсаторы (керамические, пленочные, электролитические), за счёт заключения дистрибьюторских договоров

Мы предлагаем:

- Конкуренеспособные цены и скидки постоянным клиентам.
- Специальные условия для постоянных клиентов.
- Подбор аналогов.
- Поставку компонентов в любых объемах, удовлетворяющих вашим потребностям.
- Приемлемые сроки поставки, возможна ускоренная поставка.
- Доставку товара в любую точку России и стран СНГ.
- Комплексную поставку.
- Работу по проектам и поставку образцов.
- Формирование склада под заказчика.
- Сертификаты соответствия на поставляемую продукцию (по желанию клиента).
- Тестирование поставляемой продукции.
- Поставку компонентов, требующих военную и космическую приемку.
- Входной контроль качества.
- Наличие сертификата ISO.

В составе нашей компании организован Конструкторский отдел, призванный помогать разработчикам, и инженерам.

Конструкторский отдел помогает осуществить:

- Регистрацию проекта у производителя компонентов.
- Техническую поддержку проекта.
- Защиту от снятия компонента с производства.
- Оценку стоимости проекта по компонентам.
- Изготовление тестовой платы монтаж и пусконаладочные работы.



Тел: +7 (812) 336 43 04 (многоканальный)

Email: [org@lifeelectronics.ru](mailto:org@lifeelectronics.ru)