

MAXIM

1.25Ω, Dual SPST, CMOS Analog Switches

MAX4680/MAX4690/MAX4700

General Description

The MAX4680/MAX4690/MAX4700 dual analog switches feature low on-resistance of 1.25Ω max. On-resistance is matched between switches to 0.3Ω max and is flat (0.3Ω max) over the specified signal range. Each switch can handle Rail-to-Rail® analog signals. Off-leakage current is only 5nA max at +85°C. These analog switches are ideal in low-distortion applications and are the preferred solution over mechanical relays in automatic test equipment or applications where current switching is required. They have low power requirements, require less board space, and are more reliable than mechanical relays.

The MAX4680 has two NC (normally closed) switches, and the MAX4690 has two NO (normally open) switches. The MAX4700 has one NC and one NO switch and features guaranteed break-before-make switching.

These devices operate from a +4.5V to +36V single supply or from ±4.5V to ±20V dual supplies. A separate logic supply pin guarantees TTL/CMOS-logic compatibility while operating across the entire supply voltage range.

Applications

Reed Relay Replacement Data Acquisition Systems
 Test Equipment Sample-and-Hold Circuits
 Communication Systems
 PBX, PABX Systems

Features

- ◆ Low On-Resistance (1.25Ω max)
- ◆ Guaranteed R_{ON} Match Between Channels (0.3Ω max)
- ◆ Guaranteed R_{ON} Flatness Over Specified Signal Range (0.3Ω max)
- ◆ Rail-to-Rail Signal Handling
- ◆ Guaranteed Break-Before-Make (MAX4700)
- ◆ +4.5V to +36V Single-Supply Operation
 ±4.5V to ±20V Dual-Supply Operation
- ◆ TTL/CMOS-Compatible Control Inputs
- ◆ >2kV ESD Protection per Method 3015.7

Ordering Information

PART	TEMP. RANGE	PIN-PACKAGE
MAX4680CAE	0°C to +70°C	16 SSOP
MAX4680CWE	0°C to +70°C	16 Wide SO
MAX4680CPE	0°C to +70°C	16 Plastic DIP
MAX4680EAE	-40°C to +85°C	16 SSOP
MAX4680EWE	-40°C to +85°C	16 Wide SO
MAX4680EPE	-40°C to +85°C	16 Plastic DIP

Ordering Information continued at end of data sheet.

Pin Configurations/Functional Diagrams/Truth Tables

TOP VIEW

SSOP/SO/DIP

MAX4680	
LOGIC	SWITCH
0	ON
1	OFF

N.C. = NOT INTERNALLY CONNECTED

SSOP/SO/DIP

MAX4690	
LOGIC	SWITCH
0	OFF
1	ON

SWITCHES SHOWN FOR LOGIC "0" INPUT

SSOP/SO/DIP

MAX4700		
LOGIC	SWITCH 1	SWITCH 2
0	OFF	ON
1	ON	OFF

Rail-to-Rail is a registered trademark of Nippon Motorola, Ltd.



Maxim Integrated Products 1

For free samples & the latest literature: <http://www.maxim-ic.com>, or phone 1-800-998-8800.
 For small orders, phone 1-800-835-8769.

1.25Ω, Dual SPST, CMOS Analog Switches

ABSOLUTE MAXIMUM RATINGS

V+ to GND	-0.3V to +44V
V- to GND	+0.3V to -44V
V+ to V-	-0.3V to +44V
V _L to GND	-0.3V to (V+ + 0.3V)
All Other Pins to GND (Note 1)	(V- - 0.3V) to (V+ + 0.3V)
Continuous Current (COM ₋ , NO ₋ , NC ₋)	±200mA
Peak Current (COM ₋ , NO ₋ , NC ₋) (pulsed at 1ms, 10% duty cycle)	±300mA

Continuous Power Dissipation (T _A = +70°C)	
SSOP (derate 7.1mW/°C above +70°C)	571mW
Wide SO (derate 9.52mW/°C above +70°C)	762mW
Plastic DIP (derate 10.53mW/°C above +70°C)	842mW
Operating Temperature Ranges	
MAX4_ ₀ C_E	0°C to +70°C
MAX4_ ₀ E_E	-40°C to +85°C
Storage Temperature Range	-65°C to +150°C
Lead Temperature (soldering, 10sec)	+300°C

Note 1: Signals on NC₋, NO₋, COM₋, or IN₋ exceeding V+ or V- are clamped by internal diodes. Limit forward diode current to maximum current rating.

Stresses beyond those listed under "Absolute Maximum Ratings" may cause permanent damage to the device. These are stress ratings only, and functional operation of the device at these or any other conditions beyond those indicated in the operational sections of the specifications is not implied. Exposure to absolute maximum rating conditions for extended periods may affect device reliability.

ELECTRICAL CHARACTERISTICS—Dual Supplies

(V+ = +15V, V- = -15V, V_L = +5V, V_{IN_H} = +2.4V, V_{IN_L} = +0.8V, T_A = T_{MIN} to T_{MAX}, unless otherwise noted. Typical values are at T_A = +25°C.) (Note 2)

PARAMETER	SYMBOL	CONDITIONS	MIN	TYP	MAX	UNITS
ANALOG SWITCH						
Input Voltage Range (Note 3)	V _{COM₋} , V _{NO₋} , V _{NC₋}		V-		V+	V
COM ₋ to NO ₋ or NC ₋ On-Resistance	R _{ON}	I _{COM₋} = 10mA, V _{NO₋} or V _{NC₋} = ±10V, T _A = +25°C		0.9	1.25	Ω
		T _A = T _{MIN} to T _{MAX}			1.5	
COM ₋ to NO ₋ or NC ₋ On-Resistance Match Between Channels (Notes 3, 4)	ΔR _{ON}	I _{COM₋} = 10mA, V _{NO₋} or V _{NC₋} = ±10V, T _A = +25°C		0.09	0.3	Ω
		T _A = T _{MIN} to T _{MAX}			0.5	
COM ₋ to NO ₋ or NC ₋ On-Resistance Flatness (Notes 3, 5)	R _{FLAT(ON)}	I _{COM₋} = 10mA; V _{NO₋} or V _{NC₋} = -5V, 0, 5V, T _A = +25°C		0.06	0.3	Ω
		T _A = T _{MIN} to T _{MAX}			0.5	
Off-Leakage Current (NO ₋ or NC ₋) (Note 6)	I _{NO₋} , I _{NC₋}	V _{COM₋} = ±10V, V _{NO₋} or V _{NC₋} = ∓10V, T _A = +25°C	-0.5	0.01	0.5	nA
		T _A = T _{MIN} to T _{MAX}	-5		5	
COM ₋ Off-Leakage Current (Note 6)	I _{COM₋(OFF)}	V _{COM₋} = ±10V, V _{NO₋} or V _{NC₋} = ∓10V, T _A = +25°C	-0.5	0.01	0.5	nA
		T _A = T _{MIN} to T _{MAX}	-2.5		2.5	
COM ₋ On-Leakage Current (Note 6)	I _{COM₋(ON)}	V _{COM₋} = ±10V, V _{NO₋} or V _{NC₋} = ±10V or floating, T _A = +25°C	-1	0.01	1	nA
		T _A = T _{MIN} to T _{MAX}	-20		20	
LOGIC INPUT						
Input Current with Input Voltage High	I _{IN_H}	I _{IN₋} = 2.4V, all others = 0.8V	-0.5	0.001	0.5	μA
Input Current with Input Voltage Low	I _{IN_L}	I _{IN₋} = 0.8V, all others = 2.4V	-0.5	0.001	0.5	

1.25Ω, Dual SPST, CMOS Analog Switches

MAX4680/MAX4690/MAX4700

ELECTRICAL CHARACTERISTICS—Dual Supplies (continued)

(V+ = +15V, V- = -15V, VL = +5V, VIN_H = +2.4V, VIN_L = +0.8V, TA = TMIN to TMAX, unless otherwise noted. Typical values are at TA = +25°C.) (Note 2)

PARAMETER	SYMBOL	CONDITIONS		MIN	TYP	MAX	UNITS
Logic Input Voltage High	VIN_H			2.4			V
Logic Input Voltage Low	VIN_L					0.8	V
POWER SUPPLY							
Power-Supply Range				±4.5		±20.0	V
Positive Supply Current	I+	VIN_ = 0 or 5V	TA = +25°C	-0.5	0.01	0.5	μA
			TA = TMIN to TMAX	-5		5	
Negative Supply Current	I-	VIN_ = 0 or 5V	TA = +25°C	-0.5	0.01	0.5	μA
			TA = TMIN to TMAX	-5		5	
Logic Supply Current	IL	VIN_ = 0 or 5V	TA = +25°C	-0.5	0.01	0.5	μA
			TA = TMIN to TMAX	-5		5	
Ground Current	IGND	VIN_ = 0 or 5V	TA = +25°C	-0.5	0.01	0.5	μA
			TA = TMIN to TMAX	-5		5	
SWITCH DYNAMIC CHARACTERISTICS							
Turn-On Time	tON	VCOM_ = ±10V, Figure 2	TA = +25°C		130	275	ns
			TA = TMIN to TMAX			400	
Turn-Off Time	tOFF	VCOM_ = ±10V, Figure 2	TA = +25°C		90	175	ns
			TA = TMIN to TMAX			300	
Break-Before-Make Time (MAX4700 only)	tOPEN	VCOM_ = ±10V, Figure 3, TA = +25°C		5	30		ns
Charge Injection	Q	CL = 1.0nF, VGEN = 0, RGEN = 0, Figure 4			550		pC
Off-Isolation (Note 7)	VISO	RL = 50Ω, CL = 5pF, f = 1MHz, Figure 5			-53		dB
Crosstalk (Note 8)	VCT	RL = 50Ω, CL = 5pF, f = 1MHz, Figure 6			-65		dB
NC_ or NO_ Capacitance	COFF	f = 1MHz, Figure 7			115		pF
COM Off-Capacitance	CCOM	f = 1MHz, Figure 7			115		pF
On-Capacitance	CCOM	f = 1MHz, Figure 8			520		pF

1.25Ω, Dual SPST, CMOS Analog Switches

ELECTRICAL CHARACTERISTICS—Single Supply

(V₊ = +12V, V₋ = 0, V_L = +5V, V_{INH} = 2.4V, V_{INL} = 0.8V, T_A = T_{MIN} to T_{MAX}, unless otherwise noted. Typical values are at T_A = +25°C.) (Note 2)

PARAMETER	SYMBOL	CONDITIONS	MIN	TYP	MAX	UNITS	
ANALOG SWITCH							
Input Voltage Range (Note 3)	V _{COM_} , V _{NO_} , V _{NC_}		GND		V ₊	V	
COM ₋ to NO ₋ or NC ₋ On-Resistance	R _{ON}	I _{COM_} = 10mA, V _{NO_} or V _{NC_} = 10V	T _A = +25°C	1.6	3	Ω	
			T _A = T _{MIN} to T _{MAX}		3.5		
COM ₋ to NO ₋ or NC ₋ On-Resistance Match Between Channels (Notes 3, 4)	ΔR _{ON}	I _{COM_} = 10mA, V _{NO_} or V _{NC_} = 10V	T _A = +25°C	0.1	0.4	Ω	
			T _A = T _{MIN} to T _{MAX}		0.5		
COM ₋ to NO ₋ or NC ₋ On-Resistance Flatness (Notes 3, 5)	R _{FLAT(ON)}	I _{COM_} = 10mA; V _{NO_} or V _{NC_} = 3V, 6V, 9V	T _A = +25°C	0.2	0.4	Ω	
			T _A = T _{MIN} to T _{MAX}		0.5		
Off-Leakage Current (NO ₋ or NC ₋) (Notes 6, 9)	I _{NO_} , I _{NC_}	V _{COM_} = 1V, 10V; V _{NO_} or V _{NC_} = 10V, 1V	T _A = +25°C	-0.5	0.01	0.5	nA
			T _A = T _{MIN} to T _{MAX}	-5		5	
COM ₋ Off-Leakage Current (Notes 6, 9)	I _{COM_(OFF)}	V _{NO_} or V _{NC_} = 10V, 1V; V _{COM_} = 1V, 10V	T _A = +25°C	-0.5	0.01	0.5	nA
			T _A = T _{MIN} to T _{MAX}	-5		5	
COM ₋ On-Leakage Current (Notes 6, 9)	I _{COM_(ON)}	V _{COM_} = 1V, 10V; V _{NO_} or V _{NC_} = 1V, 10V, or floating	T _A = +25°C	-1	0.02	1	nA
			T _A = T _{MIN} to T _{MAX}	-20		20	
LOGIC INPUT							
Input Current with Input Voltage High	I _{IN_H}	I _{N_} = 2.4V, all others = 0.8V	-0.5	0.001	0.5	μA	
Input Current with Input Voltage Low	I _{IN_L}	I _{N_} = 0.8V, all others = 2.4V	-0.5	0.001	0.5	μA	
Logic Input Voltage High	V _{IN_H}		2.4			V	
Logic Input Voltage Low	V _{IN_L}				0.8	V	
POWER SUPPLY							
Power-Supply Range			+4.5		+36.0	V	
Positive Supply Current	I ₊	V _{IN_} = 0 or 5V	T _A = +25°C	-0.5	0.001	0.5	μA
			T _A = T _{MIN} to T _{MAX}	5		5	
Logic Supply Current	I _L	V _{IN_} = 0 or 5V	T _A = +25°C	-0.5	0.001	0.5	μA
			T _A = T _{MIN} to T _{MAX}	5		5	
Ground Current	I _{GND}	V _{IN_} = 0 or 5V	T _A = +25°C	-0.5	0.001	0.5	μA
			T _A = T _{MIN} to T _{MAX}	5		5	

1.25Ω, Dual SPST, CMOS Analog Switches

MAX4680/MAX4690/MAX4700

ELECTRICAL CHARACTERISTICS—Single Supply (continued)

($V_+ = +12V$, $V_- = 0$, $V_L = +5V$, $V_{IN_H} = 2.4V$, $V_{IN_L} = 0.8V$, $T_A = T_{MIN}$ to T_{MAX} , unless otherwise noted. Typical values are at $T_A = +25^\circ C$.) (Note 2)

PARAMETER	SYMBOL	CONDITIONS	MIN	TYP	MAX	UNITS
SWITCH DYNAMIC CHARACTERISTICS						
Turn-On Time (Note 3)	t_{ON}	$V_{COM_} = 10V$, Figure 2	$T_A = +25^\circ C$	225	400	ns
			$T_A = T_{MIN}$ to T_{MAX}		500	
Turn-Off Time (Note 3)	t_{OFF}	$V_{COM_} = 10V$, Figure 2	$T_A = +25^\circ C$	100	250	ns
			$T_A = T_{MIN}$ to T_{MAX}		350	
Break-Before-Make Time (Note 3)	t_{OPEN}	$V_{COM_} = 10V$, Figure 3, $T_A = +25^\circ C$	5	125		ns
Charge Injection	Q	$C_L = 1.0nF$, $V_{GEN} = 0$, $R_{GEN} = 0$, Figure 4		-60		pC
Crosstalk (Note 8)	V_{CT}	$R_L = 50\Omega$, $C_L = 5pF$, $f = 1MHz$, Figure 6		-65		dB
NC_ or NO_ Capacitance	C_{OFF}	$f = 1MHz$, Figure 7		175		pF
COM Off-Capacitance	C_{COM}	$f = 1MHz$, Figure 7		175		pF
On-Capacitance	C_{COM}	$f = 1MHz$, Figure 8		275		pF

Note 2: The algebraic convention, where the most negative value is a minimum and the most positive value a maximum, is used in this data sheet.

Note 3: Guaranteed by design.

Note 4: $\Delta R_{ON} = R_{ON(MAX)} - R_{ON(MIN)}$.

Note 5: Flatness is defined as the difference between the maximum and minimum value of on-resistance as measured over the specified analog signal range.

Note 6: Leakage parameters are 100% tested at maximum-rated hot temperature and guaranteed by correlation at $+25^\circ C$.

Note 7: Off-isolation = $20\log_{10} [V_{COM} / (V_{NC}$ or $V_{NO})]$, V_{COM} = output, V_{NC} or V_{NO} = input to off switch.

Note 8: Between any two switches.

Note 9: Leakage testing at single supply is guaranteed by testing with dual supplies.

Typical Operating Characteristics

($T_A = +25^\circ C$, unless otherwise noted.)

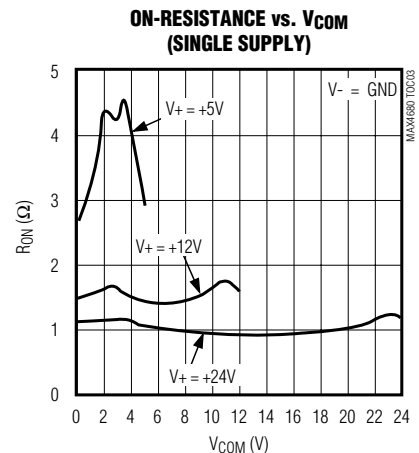
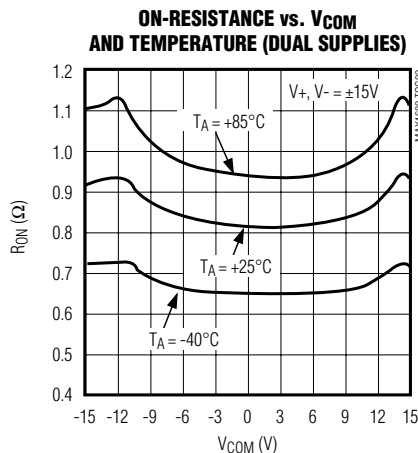
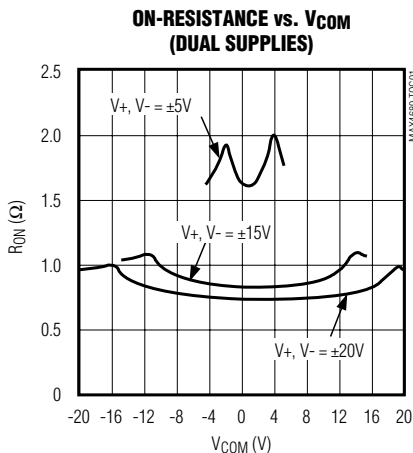

1.25Ω, Dual SPST, CMOS Analog Switches

Typical Operating Characteristics (continued)

(T_A = +25°C, unless otherwise noted.)

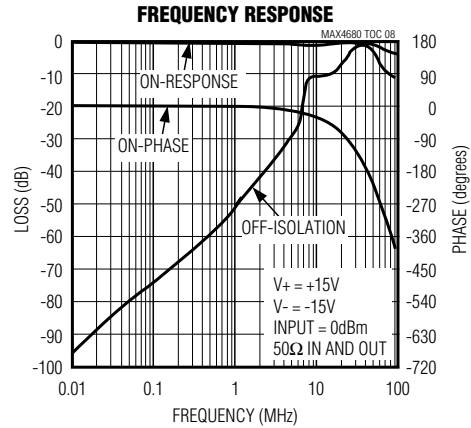
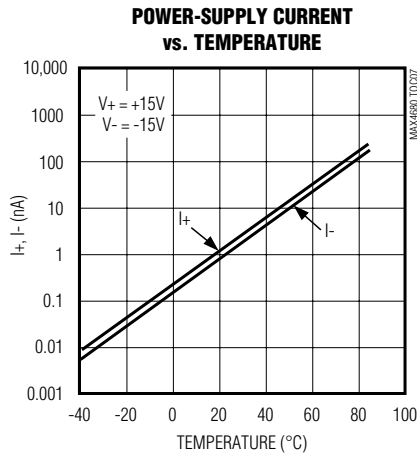
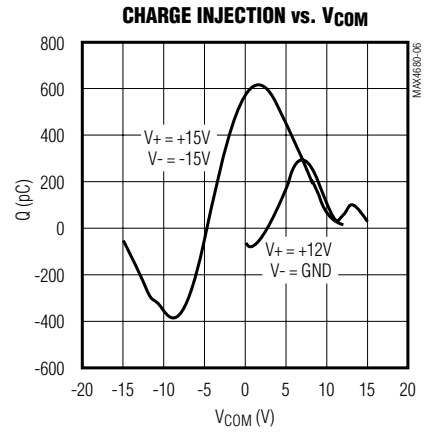
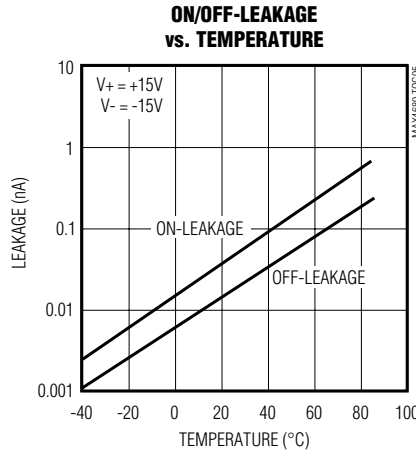
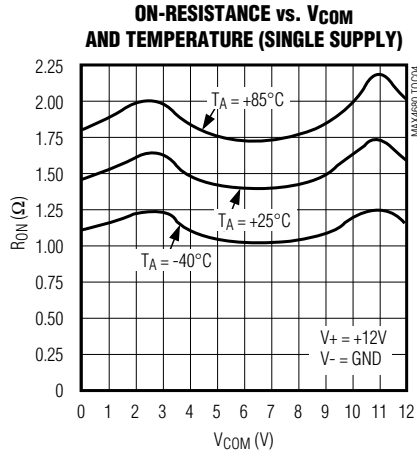

1.25Ω, Dual SPST, CMOS Analog Switches

Pin Description

MAX4680/MAX4690/MAX4700

PIN			NAME	FUNCTION
MAX4680	MAX4690	MAX4700		
1, 3, 6, 8, 10, 15	1, 3, 6, 8, 10, 15	1, 3, 6, 8, 10, 15	N.C.	No connection. Not internally connected. Connect to GND or low-impedance point to improve on/off-isolation.
2, 7	2, 7	2, 7	IN1, IN2	Logic-Control Digital Inputs
4	4	4	V-	Negative Analog Supply Voltage Input. Connect to GND for single-supply operation.
5	5	5	GND	Ground
9, 16	–	–	NC2, NC1	Analog Switch Normally Closed Terminals
11, 14	11, 14	11, 14	COM2, COM1	Analog Switch Common Terminals
12	12	12	V _L	Logic Supply Input
13	13	13	V+	Positive Analog Supply Input
–	9, 16	–	NO2, NO1	Analog Switch Normally Open Terminals
–	–	9	NC1	Analog Switch Normally Closed Terminal
–	–	16	NO1	Analog Switch Normally Open Terminal

1.25Ω, Dual SPST, CMOS Analog Switches

Applications Information

Overvoltage Protection

Proper power-supply sequencing is recommended for all CMOS devices. Do not exceed the absolute maximum ratings because stresses beyond the listed ratings can cause permanent damage to the devices. Always sequence V+ on first, then V-, followed by the logic inputs, NO, or COM. If power-supply sequencing is not possible, add two small signal diodes (D1, D2) in series with the supply pins and a Schottky diode between V+ and VL for overvoltage protection (Figure 1). Adding diodes reduces the analog signal range to one diode drop below V+ and one diode drop above V-, but does not affect the devices' low switch resistance and low-leakage characteristics. Device operation is unchanged, and the difference between V+ and V- should not exceed 44V.



Figure 1. Overvoltage Protection Using External Blocking Diodes



Figure 2. Switching-Time Test Circuit

1.25Ω, Dual SPST, CMOS Analog Switches

MAX4680/MAX4690/MAX4700

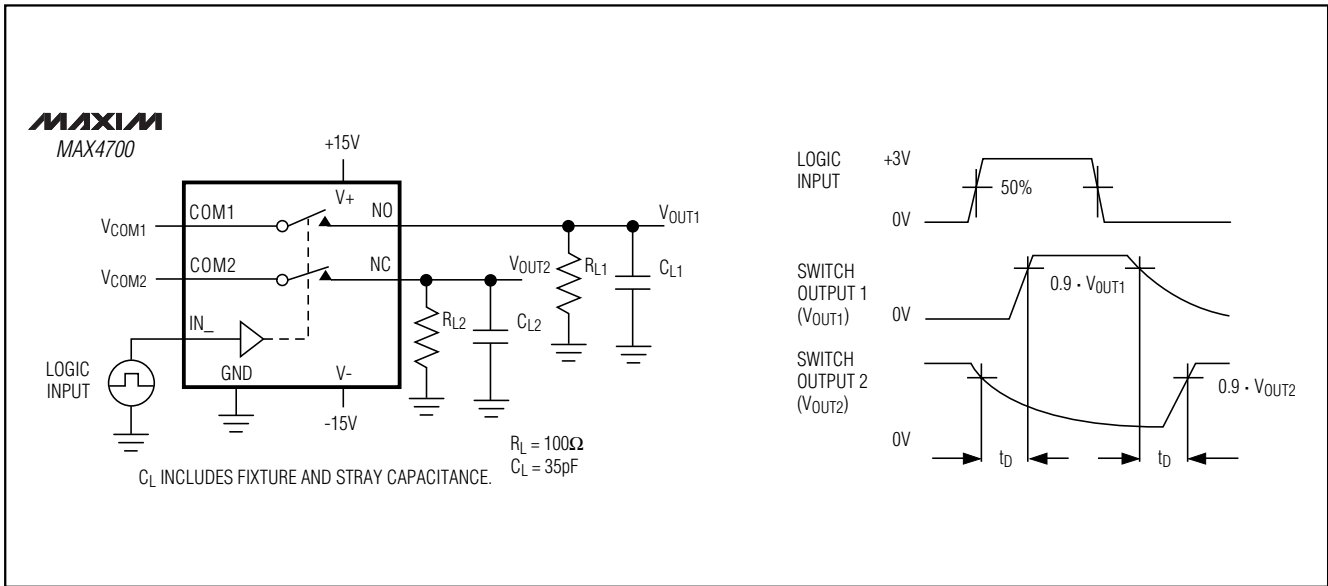

Figure 3. Break-Before-Make Interval (MAX4700 only)



Figure 4. Charge-Injection Test Circuit

1.25Ω, Dual SPST, CMOS Analog Switches



Figure 5. Off-Isolation Test Circuit



Figure 6. Crosstalk Test Circuit

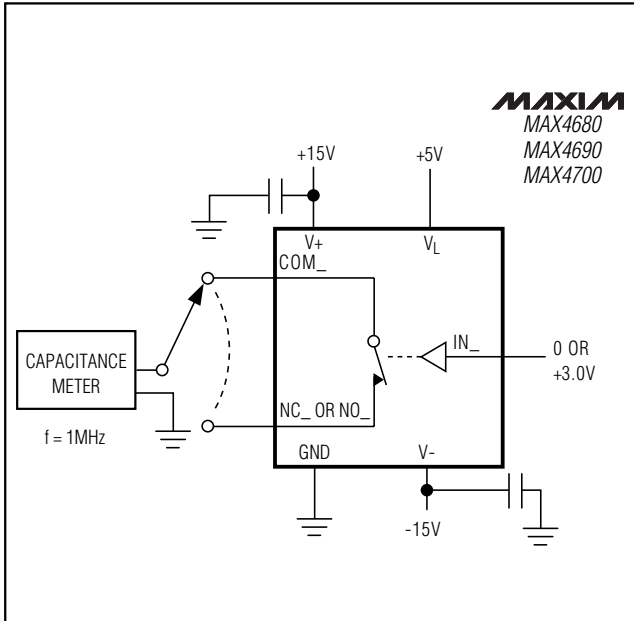

Figure 7. Switch Off-Capacitance Test Circuit



Figure 8. Switch On-Capacitance Test Circuit

1.25Ω, Dual SPST, CMOS Analog Switches

MAX4680/MAX4690/MAX4700

Ordering Information (continued)

PART	TEMP. RANGE	PIN-PACKAGE
MAX4690CAE	0°C to +70°C	16 SSOP
MAX4690CWE	0°C to +70°C	16 Wide SO
MAX4690CPE	0°C to +70°C	16 Plastic DIP
MAX4690EAE	-40°C to +85°C	16 SSOP
MAX4690EWE	-40°C to +85°C	16 Wide SO
MAX4690EPE	-40°C to +85°C	16 Plastic DIP
MAX4700CAE	0°C to +70°C	16 SSOP
MAX4700CWE	0°C to +70°C	16 Wide SO
MAX4700CPE	0°C to +70°C	16 Plastic DIP
MAX4700EAE	-40°C to +85°C	16 SSOP
MAX4700EWE	-40°C to +85°C	16 Wide SO
MAX4700EPE	-40°C to +85°C	16 Plastic DIP

Chip Information

TRANSISTOR COUNT: 108

Package Information

DIM	INCHES		MILLIMETERS	
	MIN	MAX	MIN	MAX
A	0.068	0.078	1.73	1.99
A1	0.002	0.008	0.05	0.21
B	0.010	0.015	0.25	0.38
C	0.004	0.008	0.09	0.20
D	SEE VARIATIONS			
E	0.205	0.209	5.20	5.38
e	0.0256	BSC	0.65	BSC
H	0.301	0.311	7.65	7.90
L	0.025	0.037	0.63	0.95
α	0°	8°	0°	8°

D	INCHES		MILLIMETERS		
	MIN	MAX	MIN	MAX	
D	0.239	0.249	6.07	6.33	14L
D	0.239	0.249	6.07	6.33	16L
D	0.278	0.289	7.07	7.33	20L
D	0.317	0.328	8.07	8.33	24L
D	0.397	0.407	10.07	10.33	28L

NOTES:

- D&E DO NOT INCLUDE MOLD FLASH.
- MOLD FLASH OR PROTRUSIONS NOT TO EXCEED .15mm (.006")
- CONTROLLING DIMENSION: MILLIMETER

PROPRIETARY INFORMATION

TITLE: PACKAGE OUTLINE, SSOP, 5.3X.65mm

APPROVAL	DOCUMENT CONTROL NO.	REV	1/1
	21-0056	A	

1.25Ω, Dual SPST, CMOS Analog Switches

Package Information (continued)

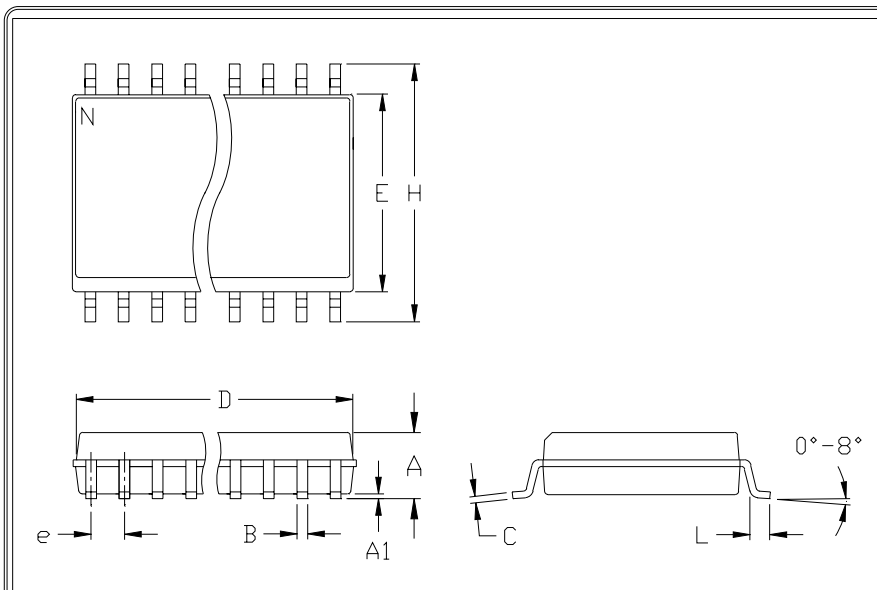

	INCHES		MILLIMETERS	
	MIN	MAX	MIN	MAX
A	0.093	0.104	2.35	2.65
A1	0.004	0.012	0.10	0.30
B	0.014	0.019	0.35	0.49
C	0.009	0.013	0.23	0.32
e	0.050		1.27	
E	0.291	0.299	7.40	7.60
H	0.394	0.419	10.00	10.65
h	0.010	0.030	0.25	0.75
L	0.016	0.050	0.40	1.27

	INCHES		MILLIMETERS		N	MS013
	MIN	MAX	MIN	MAX		
D	0.398	0.413	10.10	10.50	16	AA
D	0.447	0.463	11.35	11.75	18	AB
D	0.496	0.512	12.60	13.00	20	AC
D	0.598	0.614	15.20	15.60	24	AD
D	0.697	0.713	17.70	18.10	28	AE

- NOTES:
1. D&E DO NOT INCLUDE MOLD FLASH
 2. MOLD FLASH OR PROTRUSIONS NOT TO EXCEED .15mm (.006")
 3. LEADS TO BE COPLANAR WITHIN .102mm (.004")
 4. CONTROLLING DIMENSION: MILLIMETER
 5. MEETS JEDEC MS013-XX AS SHOWN IN ABOVE TABLE
 6. N = NUMBER OF PINS

 <small>120 SAN GABRIEL DR. SUNNYVALE, CA 94086 FAX (408) 737-7704</small> <small>PROPRIETARY INFORMATION</small>	PACKAGE FAMILY OUTLINE: SOIC .300"		21-0042	

Maxim cannot assume responsibility for use of any circuitry other than circuitry entirely embodied in a Maxim product. No circuit patent licenses are implied. Maxim reserves the right to change the circuitry and specifications without notice at any time.

12 **Maxim Integrated Products, 120 San Gabriel Drive, Sunnyvale, CA 94086 408-737-7600**

Компания «Life Electronics» занимается поставками электронных компонентов импортного и отечественного производства от производителей и со складов крупных дистрибьюторов Европы, Америки и Азии.

С конца 2013 года компания активно расширяет линейку поставок компонентов по направлению коаксиальный кабель, кварцевые генераторы и конденсаторы (керамические, пленочные, электролитические), за счёт заключения дистрибьюторских договоров

Мы предлагаем:

- Конкурентоспособные цены и скидки постоянным клиентам.
- Специальные условия для постоянных клиентов.
- Подбор аналогов.
- Поставку компонентов в любых объемах, удовлетворяющих вашим потребностям.
- Приемлемые сроки поставки, возможна ускоренная поставка.
- Доставку товара в любую точку России и стран СНГ.
- Комплексную поставку.
- Работу по проектам и поставку образцов.
- Формирование склада под заказчика.
- Сертификаты соответствия на поставляемую продукцию (по желанию клиента).
- Тестирование поставляемой продукции.
- Поставку компонентов, требующих военную и космическую приемку.
- Входной контроль качества.
- Наличие сертификата ISO.

В составе нашей компании организован Конструкторский отдел, призванный помогать разработчикам, и инженерам.

Конструкторский отдел помогает осуществить:

- Регистрацию проекта у производителя компонентов.
- Техническую поддержку проекта.
- Защиту от снятия компонента с производства.
- Оценку стоимости проекта по компонентам.
- Изготовление тестовой платы монтаж и пусконаладочные работы.



Тел: +7 (812) 336 43 04 (многоканальный)
Email: org@lifeelectronics.ru