

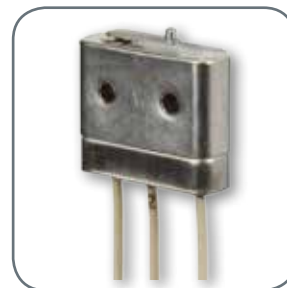

MICRO SWITCH™
Hermetic Sealed Basic Switches
HM Series



MICRO SWITCH™ HM Series

Hermetic Sealed Basic Switches

Honeywell HM hermetic sealed miniature basic switches are designed for a variety of commercial and military aircraft as well as equipment for deep space applications (high altitude requirements). These miniature hermetic sealed switches can be found in a variety of other applications including military land vehicles, marine environments, and other harsh industrial environments. The switches are available as a MIL-PRF-8805 qualified switch. Select HM switches are available with UL 508 certification for industrial or surface transportation applications. The MICRO SWITCH™ HM hermetic sealed switch design incorporates the glass-to-metal and metal-to-metal sealing with more than 50 years of use in multiple applications.

The hermetically sealed HM basic switches are ideal where a symbol 5 seal is required for stringent applications including a wide range of temperatures from -184 °C to 260 °C [-300 °F to 500 °F]. Designed with a stainless steel housing and hermetic seal construction, the HM switches are suitable for applications where dust, water, other particulate contaminants, and corrosive gases are present.

The HM basic switch provides versatility with bifurcated gold contacts for controlling low energy loads (mA and mV) reliably or silver contacts for switching power duty loads at 30 vdc or 115 Vac, 400 Hz. Electrical connectivity to the switch is achieved with individual wire leads or “through hole” solder posts adding to the versatility of the HM switch.

What makes our switches better?

- Precisely detects position of mechanical components within a particular system that is susceptible to physical and atmospheric (corrosive gas, oxygen, etc.) elements
- Consistent and precise performance in a hermetic-sealed package for adverse, inclement environments
- Functionality over a large temperature range – can tolerate very low and high temperatures
- Honeywell can create value-added HM assemblies for unique, custom applications beyond a simple HM switch
- HM switches are available with MIL-PRF-8805 qualifications or UL 508 certifications



HM Series: when you need a switch with out-of-this-world performance!

HIGH PERFORMANCE • DURABILITY
CONFIGURABLE • COMPACT

Features and Benefits

MIL-QUALIFIED

MICRO SWITCH™ HM switches are **hermetically sealed** with versions that are **MIL-PRF-8805** qualified for demanding military or commercial applications on aircraft, spacecraft, or ground vehicles.

UL CERTIFIED

Select HM catalog listings are **UL 508 certified** for industrial and surface transportation applications.

TINY

Miniature package size requires minimal space on equipment.

Hermetically sealed with wide temperature range

SEALED TIGHT

HM Series' **Symbol 5** hermetic-sealed enclosures are suitable for applications at sea level, high altitude, or deep space.

LOW VOLTAGE AND POWER DUTY CAPABILITY

MICRO SWITCH™ HM products are available with **silver contacts** for control of power duty circuits or **gold contact surfaces** for control of logic level circuits.

LEVERS FURTHER EXPAND FUNCTIONALITY

Auxiliary actuators expand the versatility of the switch for additional applications.

WELL SUITED FOR LOW AND HIGH TEMPERATURES

For endurance in harsh temperature environments, **wide temperature range** is available from -184 °C to 260 °C [-300 °F to 500 °F]. Operate point stability is maintained over the specified temperature range.

Potential Applications



MILITARY AIRCRAFT AND HELICOPTERS

- Detects landing gear bay doors in closed and locked position
- Senses engine fuel valve position
- Identifies when external hatches and doors are in closed and/or locked position

COMMERCIAL AIRCRAFT AND HELICOPTERS

- Detects landing gear bay doors in closed and locked position
- Senses engine fuel valve position
- Identifies when external hatches and doors are in closed and/or locked position
- Miscellaneous applications inside commercial aircraft cabin, including waste management valve position, refreshment (liquids and food) stowed and locked position, HVAC, and oxygen valve position



AVIATION GROUND SUPPORT EQUIPMENT

- Monitor position of valves, doors or panels, for open, closed, or locked position

SPACECRAFT

- Identifies when external hatches and doors are in closed and/or locked position
- Senses engine fuel valve position
- Select sensing applications inside spacecraft cabin



POWER GENERATION, OIL AND GAS

- Internal switch element in pressure switches, temperature switches, and/or flow switches

MICRO SWITCH™ Hermetic Sealed Basic Switches

Table 1. Specifications

Characteristic	
Description	hermetic sealed miniature snap-action switch
Housing material	300 series stainless steel
Mechanical endurance	25,000 operations min.
Electrical endurance	25,000 operations min.
Dielectric voltage (initial)	1000 Vrms for 1 minute
Circuitry	SPDT
Contact material	silver, gold, gold bifurcated
Electrical rating	up to 4 A at 28 Vdc (ref. electrical rating table)
Sealing	symbol 5, hermetic sealed to MIL-PRF-8805
Temperature range	-65 °C to 121 °C [-85 °F to 250 °F] (see catalog listing table)
Temperature range (optional)	-184 °C to 260 °C [-300 °F to 500 °F] (see catalog listing table)
Vibration	symbol 2 (15 g), 10 to 2000 Hz
Mechanical shock	shock type M (100 G, saw tooth)
Approvals (refer to page 7)	MIL-PRF-8805, UL 508 (File E66520)
Actuators (auxiliary)	straight leaf, roller leaf, straight lever, roller lever

Table 2. Electrical Ratings

Rating code	
A	sea level @ 28 Vdc; 3 A res. and 1 A ind. 70,000 feet @ 28 Vdc; 3 A res. and 1 A ind. sea level @ 115 Vac & 400 Hz; 1 A res. and 1 A ind.
B	sea level @ 28 Vdc; 1 A res. and 0.25 A ind. 70,000 feet @ 28 Vdc; 1 A res. and 0.25 A ind.
C	sea level @ 28 Vdc; 0.5 A res. and 0.25 A ind. 70,000 feet @ 28 Vdc; 0.5 A res. and 0.25 A ind.
D	sea level @ 28 Vdc; 4 A res., 2 A ind. and 1 A lamp 70,000 feet @ 28 Vdc; 4 A res., 2 A ind. and 1 A lamp sea level @ 115 Vac & 400 Hz; 2 A res., 2 A ind. and 0.5 A lamp
E	sea level @ 28 Vdc; 4 res. and 2 A ind. sea level @ 115 Vac and 400 Hz; 2.5 A res. and 2.5 A ind.

Table 3. UL 508 Electrical Ratings

Rating code	
F	28 Vdc, 0.5 A res.; -65 °C to 125 °C [-85 °F to 257 °F]
G	28 Vdc, 3 A res.; -65 °C to 125 °C [-85 °F to 257 °F]
H	28 Vdc, 0.5 A res.; -65 °C to 260 °C [-85 °F to 500 °F]
J	28 Vdc, 4 A res.; -65 °C to 260 °C [-85 °F to 500 °F]

ELECTROMECHANICAL SWITCHES

Definitions below explain the meaning of operating characteristics. Characteristics shown in tables were chosen as most significant. They are taken at normal room temperature and humidity. These may vary as temperature and humidity conditions differ. Sketches show how characteristics are measured for in-line plunger actuation.

Linear dimensions for in-line actuation are from top of plunger to a reference line, usually the center of the mounting holes.

Differential Travel (D.T.) – Plunger or actuator travel from point where contacts “snap-over” to point where they “snap-back.”

Free Position (F.P.) – Position of switch plunger or actuator when no external force is applied (other than gravity).

Full Overtravel Force – Force required to attain full overtravel of actuator.

Operating Position (O.P.) – Position of switch plunger or actuator at which point contacts snap from normal to operated position. Note that in the case of flexible or adjustable actuators, the operating position is measured from the end of the lever or its maximum length. Location of operating position measurement shown on mounting dimension drawings.

Operating Force (O.F.) – Amount of force applied to switch plunger or actuator to cause contact “snap-over.” Note in the case of adjustable actuators, the force is measured from the maximum length position of the lever.

Overtravel (O.T.) – Plunger or actuator travel safely available beyond operating position.

Pretravel (P.T.) – Distance or angle traveled in moving plunger or actuator from free position to operating position.

Release Force (R.F.) – Amount of force still applied to switch plunger or actuator at moment contacts snap from operated position to unoperated position.

Total Travel (T.T.) – Distance from actuator free position to overtravel limit position.

IN-LINE PLUNGER ACTUATION

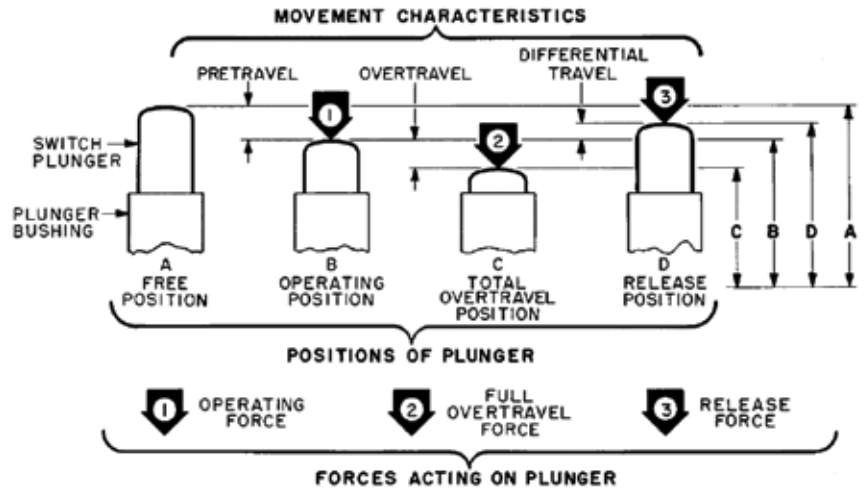





MICRO SWITCH™ Hermetic Sealed Basic Switches

- O.F. • Operating force
- R.F. • Release force
- P.T. • Pretravel
- O.T. • Overtravel
- D.T. • Differential travel
- O.P. • Operating position

MICRO SWITCH™ HM SERIES PRODUCT SPECIFICATIONS AND LISTINGS

Contact your Honeywell rep or distributor for additional listings





	Catalog Listing	Elect. Rating Spec. (page 5)	Temperature range	Termination	O.F. max. g [oz]	R.F. max. g [oz]	P.T. max. mm [in]	O.T. min. mm [in]	D.T. max. mm [in]	O.P. mm [in]	Comment
	11HM1 [MS 27216-5]	A	-184 °C to 121 °C [-300 °F to 250 °F]	Thru-hole solder post	198 [7]	28 [1]	0,76 [0.03]	0,08 [0.003]	0,15 [0.006]	8,38 [0.33]	MIL-PRF 8805 applications
	11HM1 [UL 508]	G	-65 °C to 125 °C [-85 °F to 257 °F]	Thru-hole solder post	198 [7]	28 [1]	0,76 [0.03]	0,08 [0.003]	0,15 [0.006]	8,38 [0.33]	UL 508 applications
	13HM1	B	-184 °C to 121 °C [-300 °F to 250 °F]	Thru-hole solder post	198 [7]	28 [1]	0,76 [0.03]	0,08 [0.003]	0,15 [0.006]	8,38 [0.33]	Gold contacts
	9HM1 [MS27216-6]	C	-184 °C to 121 °C [-300 °F to 250 °F]	Thru-hole solder post	198 [7]	28 [1]	0,76 [0.03]	0,08 [0.003]	0,15 [0.006]	8,38 [0.33]	MIL-PRF 8805, bifurcated gold contacts
	9HM1 [UL 508]	F	-65 °C to 125 °C [-85 °F to 257 °F]	Thru-hole solder post	198 [7]	28 [1]	0,76 [0.03]	0,08 [0.003]	0,15 [0.006]	8,38 [0.33]	UL 508 applications, bifurcated gold contacts
	2HM19-1 [MS27216-2]	D	-65 °C to 125 °C [-85 °F to 257 °F]	Wire leads (3) 305 mm [12 in]	198 [7]	28 [1]	0,76 [0.03]	0,08 [0.003]	0,15 [0.006]	8,38 [0.33]	MIL-PRF 8805 applications
	2HM19-5 [MS27216-4]	D	-65 °C to 125 °C [-85 °F to 257 °F]	Wire leads (3) 1524 mm [60 in]	198 [7]	28 [1]	0,76 [0.03]	0,08 [0.003]	0,15 [0.006]	8,38 [0.33]	MIL-PRF 8805 applications
	16HM1-1	A	-65 °C to 260 °C [-85 °F to 500 °F] (-184 °C [-300 °F] if wires non-flexing)	Wire leads (3) 305 mm [12 in]	198 [7]	28 [1]	0,76 [0.03]	0,08 [0.003]	0,15 [0.006]	8,38 [0.33]	Up to 260 °C [500 °F]
	15HM2	A	-65 °C to 260 °C [-85 °F to 500 °F]	Thru-hole post	198 [7]	28 [1]	0,76 [0.03]	0,08 [0.003]	0,15 [0.006]	8,38 [0.33]	Up to 260 °C [500 °F]
	15HM5	A	-184 °C to 260 °C [-300 °F to 500 °F]	Thru-hole solder post	198 [7]	28 [1]	0,76 [0.03]	0,08 [0.003]	0,10 [0.004]	8,38 [0.33]	Up to 260 °C [500 °F]
	5HM1	E	-184 °C to 260 °C [-300 °F to 500 °F]	Thru-hole solder post	198 [7]	28 [1]	0,76 [0.03]	0,08 [0.003]	0,15 [0.006]	8,38 [0.33]	Up to 260 °C [500 °F]
	5HM1 [UL 508]	J	-65 °C to 260 °C [-85 °F to 500 °F]	Thru-hole solder post	198 [7]	28 [1]	0,76 [0.03]	0,08 [0.003]	0,15 [0.006]	8,38 [0.33]	UL 508 applications
	19HM1	C	-184 °C to 260 °C [-300 °F to 500 °F]	Thru-hole solder post	198 [7]	28 [1]	0,76 [0.03]	0,08 [0.003]	0,15 [0.006]	8,38 [0.33]	Up to 260 °C [500 °F]
	19HM1 [UL 508]	H	-65 °C to 260 °C [-85 °F to 500 °F]	Thru-hole solder post	198 [7]	28 [1]	0,76 [0.03]	0,08 [0.003]	0,15 [0.006]	8,38 [0.33]	UL 508 applications
	19PA137-HM*	-	-	-	-	-	-	-	-	-	Force spreading plate

* Recommended to minimize force on housing of HM switch and any resulting damage to switch housing.

Note: Torque on #2 mounting screws must not exceed 0,17 Nm [1.5 in-lb]. The force spreading plate, 19PA137-HM, will allow up to 0,28 Nm [2.5 in-lb] of mounting torque.

HM Series

JS SERIES LEVERS SPECIFICATIONS* (WHEN ASSEMBLED TO 16HM1-1)

		Description	Actuator Length mm [in]	Operating Force max. g [oz]	Release Force min. g [oz]	Pretravel nom. mm [in]	Overtravel min. mm [in]	Differential Travel max. mm [in]	Operating Point nom. mm [in]	Free Position nom. mm [in]
JS-254		Straight leaf	8,13 [0.32]	255 [9]	57 [2]	3,56 [0.14]	0,76 [0.03]	0,76 [0.03]	8,64 [0.34]	12,2 [0.48]
JS-151		Roller leaf <i>(mounting hardware included)</i>	8,13 [0.32]	255 [9]	57 [2]	3,56 [0.14]	0,76 [0.03]	0,76 [0.03]	14 [0.55]	17,5 [0.69]
JS-307		Straight lever <i>(mounting hardware included)</i>	26,16 [1.03]	43 [1.5]	3 [0.11]	3,18 [0.125]	0,64 [0.025]	1,42 [0.056]	10,3 [0.406]	13,49 [0.531]
JS-308		Roller lever <i>(mounting hardware included)</i>	25,4 [1.00] radius	43 [1.5]	3 [0.11]	3,18 [0.125]	0,64 [0.025]	1,42 [0.056]	14,3 [0.562]	17,45 [0.687]

* Stainless steel actuators, including roller and mounting hardware (when provided).

MICRO SWITCH™ Hermetic Sealed Basic Switches

PRODUCT AND ACTUATOR DIMENSIONS

Figure 1. MICRO SWITCH™ HM, Solder Terminal

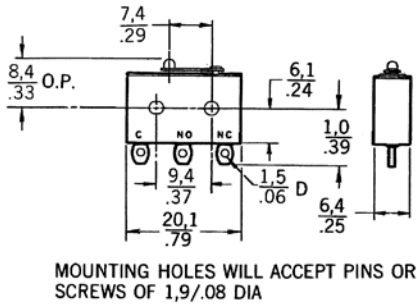

Figure 2. MICRO SWITCH™ HM, Wire Leads

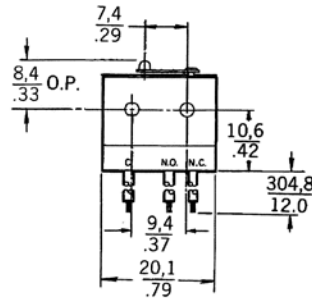

Figure 3. MICRO SWITCH™ HM, Wire Leads

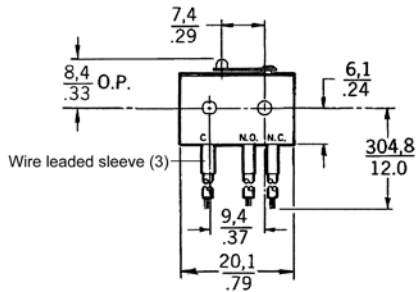

Figure 4. JS-254 Dimensions

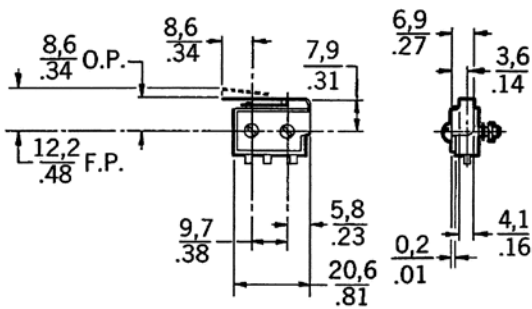

Figure 5. JS-151 Dimensions

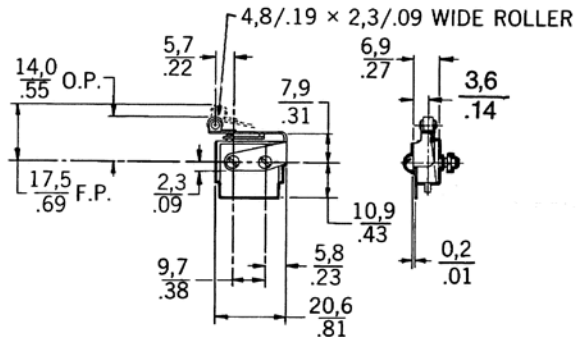

Figure 6. JS-307 Dimensions

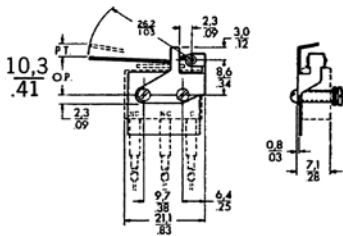
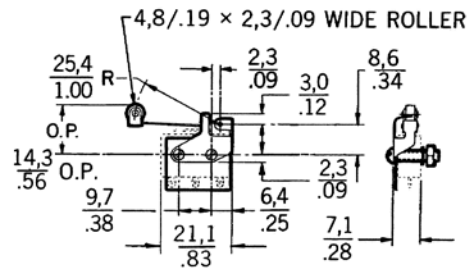

Figure 7. JS-308 Dimensions



Key: 0,0 = mm
0.00 = inches

HM Series

This Honeywell datasheet supports the following MICRO SWITCH™ HM Series Basic Switch Listings

109HM1	16HM4-LIEB	38HM39	4HM47-3
109HM41	16HM5	38HM4	4HM49
10HM1-1	17HM5	38HM42	4HM54
10HM1-2	17HM6	38HM43	4HM56
10HM1-3	18HM1-1	38HM45	4HM57
10HM2	18HM1-2	38HM46	4HM58
10HM20-1	18HM20	38HM50	4HM59
10HM21-1	18HM3-1	38HM51	4HM59-B
10HM22-1	18HM45	38HM53	4HM60
10HM23-1	18HM49	38HM54	56HM1-1
10HM25	18HM52-1	38HM55	56HM32
10HM26-10	18HM84-2	38HM56	5HM1
10HM35-3-REL-PGM	19HM1	38HM60	5HM11
10HM38-5-REL-PGM	19HM1-CB	38HM61	5HM6
10HM61	19HM2-CB	38HM62	6HM1-1
10HM70	19HM3-CB	38HM65-A	6HM1-16
112HM1-2	19HM4	38HM68	6HM1-3
114HM1-2	19HM4-CB	38HM69	6HM1-6
114HM59-B	19HM5-CB	38HM73	6HM3-1
11HM1	19HM6-CB	38HM74	6HM4
11HM25H-REL-PGM	19PA137-HM	38HM75	6HM42-1
11HM25N-REL-PGM	19PA208-HM	38HM76	6HM4-3
11HM25-REL-PGM	1HM1	38HM79	6HM48-1
11HM30N-REL-PGM	1HM11	38HM80	6HM5-2
11HM30-REL-PGM	1HM19	38HM81	6HM7-3
11HM41	1HM25-REL-PGM	38HM82	6HM7-30
11HM43	1HM30-REL-PGM	38HM87	6HM7-6
11HM65H-REL-PGM	1HM61	38HM9	6HM82
11HM65-REL-PGM	20HM1-1	38HM90	6HM83
11HM90	20HM23-1	38HM91	6HM89
120HM23-1	20HM24-1	38HM92	7HM5
120HM6-1	20HM27-3	38HM93	8HM1-1
120HM7-1	2HM1-1	38HM95	8HM73-3
120HM8-1	2HM1-3	39HM1	9HM1
120HM9-1	2HM1-6	39HM150	9HM25-REL-PGM
12HM1-1	2HM17-3	39HM165	9HM30NH-REL-PGM
12HM12-1	2HM18-3	39HM2	9HM30-REL-PGM
12HM12-2	2HM19-1	39HM28	9HM37-REL-PGM
12HM19-5	2HM19-5	39HM31	
12HM30-5-REL-PGM	2HM21-1	39HM33	
12HM8	2HM26-1	39HM47	
13HM1	2HM32-1	39HM48	
14HM19-5	2HM70	39HM50	
14HM6	38HM10	3HM1	
14HM6-1	38HM20	3HM41	
15HM2	38HM23	3HM62	
15HM5	38HM25	42HM1-1	
16HM1-1	38HM26	42HM1-1A	
16HM14	38HM27	42HM1-1B	
16HM32	38HM29	42HM2-1	
16HM4	38HM30	42HM2-1A	
16HM44-3	38HM31	42HM2-1B	
16HM44-6	38HM33	42HM3-1	
16HM456	38HM36	42HM4-1	
16HM45-6	38HM37	4HM46	

MICRO SWITCH™ Hermetic Sealed Basic Switches

ADDITIONAL INFORMATION

The following associated literature is available on the Honeywell web site at sensing.honeywell.com:

- Product installation instructions
- Product range guide
- Aerospace range guide

WARNING

PERSONAL INJURY

DO NOT USE these products as safety or emergency stop devices or in any other application where failure of the product could result in personal injury.

Failure to comply with these instructions could result in death or serious injury.

WARNING

MISUSE OF DOCUMENTATION

- The information presented in this product sheet is for reference only. Do not use this document as a product installation guide.
- Complete installation, operation, and maintenance information is provided in the instructions supplied with each product.

Failure to comply with these instructions could result in death or serious injury.

WARRANTY/REMEDY

Honeywell warrants goods of its manufacture as being free of defective materials and faulty workmanship. Honeywell's standard product warranty applies unless agreed to otherwise by Honeywell in writing; please refer to your order acknowledgement or consult your local sales office for specific warranty details. If warranted goods are returned to Honeywell during the period of coverage, Honeywell will repair or replace, at its option, without charge those items it finds defective. **The foregoing is buyer's sole remedy and is in lieu of all other warranties, expressed or implied, including those of merchantability and fitness for a particular purpose. In no event shall Honeywell be liable for consequential, special, or indirect damages.**

While we provide application assistance personally, through our literature and the Honeywell website, it is up to the customer to determine the suitability of the product in the application.

Specifications may change without notice. The information we supply is believed to be accurate and reliable as of this printing. However, we assume no responsibility for its use.

Find out more

Honeywell serves its customers through a worldwide network of sales offices, representatives and distributors. For application assistance, current specifications, pricing or name of the nearest Authorized Distributor, contact your local sales office.

To learn more about Honeywell's sensing and control products, call **+1-815-235-6847** or **1-800-537-6945**, visit **sensing.honeywell.com**, or e-mail inquiries to **info.sc@honeywell.com**

Sensing and Control
Honeywell
1985 Douglas Drive North
Golden Valley, MN 55422
honeywell.com

The Honeywell logo is displayed in a bold, red, sans-serif font.

Компания «Life Electronics» занимается поставками электронных компонентов импортного и отечественного производства от производителей и со складов крупных дистрибьюторов Европы, Америки и Азии.

С конца 2013 года компания активно расширяет линейку поставок компонентов по направлению коаксиальный кабель, кварцевые генераторы и конденсаторы (керамические, пленочные, электролитические), за счёт заключения дистрибьюторских договоров

Мы предлагаем:

- Конкурентоспособные цены и скидки постоянным клиентам.
- Специальные условия для постоянных клиентов.
- Подбор аналогов.
- Поставку компонентов в любых объемах, удовлетворяющих вашим потребностям.
- Приемлемые сроки поставки, возможна ускоренная поставка.
- Доставку товара в любую точку России и стран СНГ.
- Комплексную поставку.
- Работу по проектам и поставку образцов.
- Формирование склада под заказчика.
- Сертификаты соответствия на поставляемую продукцию (по желанию клиента).
- Тестирование поставляемой продукции.
- Поставку компонентов, требующих военную и космическую приемку.
- Входной контроль качества.
- Наличие сертификата ISO.

В составе нашей компании организован Конструкторский отдел, призванный помогать разработчикам, и инженерам.

Конструкторский отдел помогает осуществить:

- Регистрацию проекта у производителя компонентов.
- Техническую поддержку проекта.
- Защиту от снятия компонента с производства.
- Оценку стоимости проекта по компонентам.
- Изготовление тестовой платы монтаж и пусконаладочные работы.



Тел: +7 (812) 336 43 04 (многоканальный)

Email: org@lifeelectronics.ru