

FEATURES

Fixed gain of 20 dB
Operational frequency of 1 MHz to 2.7 GHz
Linear output power up to 4 dBm
Input/output internally matched to 50 Ω
Temperature and power supply stable
Noise figure: 4.2 dB
Power supply: 3 V or 5 V

APPLICATIONS

VCO buffers
General Tx/Rx amplification
Power amplifier predrivers
Low power antenna drivers

GENERAL DESCRIPTION

The [AD8354](#) is a broadband, fixed-gain, linear amplifier that operates at frequencies from 1 MHz up to 2.7 GHz. It is intended for use in a wide variety of wireless devices, including cellular, broadband, CATV, and LMDS/MMDS applications.

By taking advantage of ADI's high performance, complementary Si bipolar process, these gain blocks provide excellent stability over process, temperature, and power supply. This amplifier is single-ended and internally matched to 50 Ω with a return loss of greater than 10 dB over the full operating frequency range.

The [AD8354](#) provides linear output power of nearly 4.3 dBm with 20 dB of gain at 900 MHz when biased at 3 V and an external RF choke is connected between the power supply and the output pin. The dc supply current is 24 mA. At 900 MHz, the output third-order intercept (OIP3) is greater than 18 dBm; at 2.7 GHz, the OIP3 is 14 dBm.

FUNCTIONAL BLOCK DIAGRAM

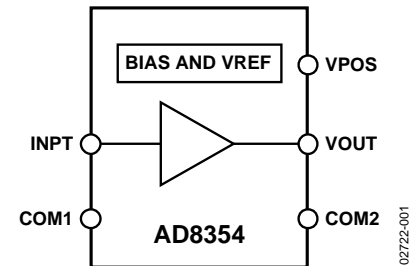

Figure 1.

The noise figure is 4.2 dB at 900 MHz. The reverse isolation (S_{12}) is -33 dB at 900 MHz.

The [AD8354](#) can also operate with a 5 V power supply; in which case, no external inductor is required. Under these conditions, the [AD8354](#) delivers 4.88 dBm with 20 dB of gain at 900 MHz. The dc supply current is 26 mA. At 900 MHz, the OIP3 is greater than 19 dBm; at 2.7 GHz, the OIP3 is 15 dBm. The noise figure is 4.4 dB at 900 MHz. The reverse isolation (S_{12}) is -33 dB.

The [AD8354](#) is fabricated on ADI's proprietary, high performance, 25 GHz, Si complementary, bipolar IC process. The [AD8354](#) is available in a chip scale package that uses an exposed paddle for excellent thermal impedance and low impedance electrical connection to ground. It operates over a -40°C to +85°C temperature range, and an evaluation board is also available.

TABLE OF CONTENTS

Features	1	Typical Performance Characteristics	7
Applications.....	1	Theory of Operation	13
Functional Block Diagram	1	Basic Connections.....	13
General Description	1	Applications Information	14
Revision History	2	Low Frequency Applications Below 100 MHz.....	14
Specifications.....	3	Evaluation Board	15
Absolute Maximum Ratings.....	5	Outline Dimensions	16
ESD Caution.....	5	Ordering Guide	16
Pin Configuration and Function Descriptions.....	6		

REVISION HISTORY

2/2017—Rev. E to Rev. F

Changed CP-8-1 to CP-8-23	Throughout
Changes to Figure 2.....	6
Changes to Ordering Guide	16
Updated Outline Dimensions	16

11/2013—Rev. D to Rev. E

Changes to Figure 2.....	6
Added Figure 35, Renumbered Sequentially	12
Added Exposed Pad Notation to Outline Dimensions	16
Changes to Ordering Guide	16

3/2009—Rev. C to Rev. D

Changes to Lead Temperature (Soldering, 60 sec) Parameter, Table 3	5
Changes to Ordering Guide	16

12/2005—Rev. B to Rev. C

Changes to Table 1.....	3
Changes to Table 2.....	4
Moved Figure 39 to Page 15; Renumbered Sequentially.....	15
Changes to Ordering Guide	16

8/2005—Rev. A to Rev. B

Updated Format.....	Universal
Changes to Product Title, Features, and General Description....	1
Changes to Basic Connections Section	13
Added Low Frequency Applications Below 100 MHz Section	14
Changes to Ordering Guide	16
Updated Outline Dimensions	16

6/2002—Rev. 0 to Rev. A

Changes to Ordering Guide	4
Replaced TPC 34	10
Updated Outline Dimensions	13

2/2002—Revision 0: Initial Version

SPECIFICATIONS

$V_S = 3\text{ V}$, $T_A = 25^\circ\text{C}$, 100 nH external inductor between VOUT and VPOS, $Z_O = 50\ \Omega$, unless otherwise noted.

Table 1.

Parameter	Conditions	Min	Typ	Max	Unit
OVERALL FUNCTION					
Frequency Range		1		2700	MHz
Gain	f = 900 MHz		19.5		dB
	f = 1.9 GHz		18.6		dB
	f = 2.7 GHz		17.1		dB
Delta Gain	f = 900 MHz, $-40^\circ\text{C} \leq T_A \leq +85^\circ\text{C}$		-0.97		dB
	f = 1.9 GHz, $-40^\circ\text{C} \leq T_A \leq +85^\circ\text{C}$		-1.05		dB
	f = 2.7 GHz, $-40^\circ\text{C} \leq T_A \leq +85^\circ\text{C}$		-1.33		dB
Gain Supply Sensitivity	VPOS $\pm 10\%$, f = 900 MHz		0.54		dB/V
	f = 1.9 GHz		0.37		dB/V
	f = 2.7 GHz		0.2		dB/V
Reverse Isolation (S_{12})	f = 900 MHz		-33.5		dB
	f = 1.9 GHz		-38		dB
	f = 2.7 GHz		-32.9		dB
RF INPUT INTERFACE					
Input Return Loss	Pin INPT				
	f = 900 MHz		24.4		dB
	f = 1.9 GHz		23		dB
	f = 2.7 GHz		12.7		dB
RF OUTPUT INTERFACE					
Output Compression Point	Pin VOUT				
	f = 900 MHz, 1 dB compression		4.6		dBm
	f = 1.9 GHz		3.7		dBm
	f = 2.7 GHz		2.7		dBm
Delta Compression Point	f = 900 MHz, $-40^\circ\text{C} \leq T_A \leq +85^\circ\text{C}$		0.7		dB
	f = 1.9 GHz, $-40^\circ\text{C} \leq T_A \leq +85^\circ\text{C}$		0.7		dB
	f = 2.7 GHz, $-40^\circ\text{C} \leq T_A \leq +85^\circ\text{C}$		0.8		dB
Output Return Loss	f = 900 MHz		23.6		dB
	f = 1.9 GHz		16.5		dB
	f = 2.7 GHz		14.6		dB
DISTORTION/NOISE					
Output Third-Order Intercept	f = 900 MHz, $\Delta f = 1\text{ MHz}$, $P_{IN} = -28\text{ dBm}$		19		dBm
	f = 1.9 GHz, $\Delta f = 1\text{ MHz}$, $P_{IN} = -28\text{ dBm}$		16		dBm
	f = 2.7 GHz, $\Delta f = 1\text{ MHz}$, $P_{IN} = -28\text{ dBm}$		14.2		dBm
Output Second-Order Intercept	f = 900 MHz, $\Delta f = 1\text{ MHz}$, $P_{IN} = -28\text{ dBm}$		29.7		dBm
Noise Figure	f = 900 MHz		4.2		dB
	f = 1.9 GHz		4.8		dB
	f = 2.7 GHz		5.4		dB
POWER INTERFACE					
Supply Voltage	Pin VPOS	2.7	3	3.3	V
Total Supply Current		16	23	31	mA
Supply Voltage Sensitivity			6.2		mA/V
Temperature Sensitivity	$-40^\circ\text{C} \leq T_A \leq +85^\circ\text{C}$		33		$\mu\text{A}/^\circ\text{C}$

$V_S = 5\text{ V}$, $T_A = 25^\circ\text{C}$, no external inductor between VOUT and VPOS, $Z_O = 50\ \Omega$, unless otherwise noted.

Table 2.

Parameter	Conditions	Min	Typ	Max	Unit
OVERALL FUNCTION					
Frequency Range		1		2700	MHz
Gain	f = 900 MHz		19.5		dB
	f = 1.9 GHz		18.7		dB
	f = 2.7 GHz		17.3		dB
Delta Gain	f = 900 MHz, $-40^\circ\text{C} \leq T_A \leq +85^\circ\text{C}$		-0.93		dB
	f = 1.9 GHz, $-40^\circ\text{C} \leq T_A \leq +85^\circ\text{C}$		-0.99		dB
	f = 2.7 GHz, $-40^\circ\text{C} \leq T_A \leq +85^\circ\text{C}$		-1.21		dB
Gain Supply Sensitivity	VPOS $\pm 10\%$, f = 900 MHz		0.32		dB/V
	f = 1.9 GHz		0.21		dB/V
	f = 2.7 GHz		0.08		dB/V
Reverse Isolation (S_{12})	f = 900 MHz		-33.5		dB
	f = 1.9 GHz		-37.6		dB
	f = 2.7 GHz		-32.9		dB
RF INPUT INTERFACE					
Input Return Loss	Pin INPT				
	f = 900 MHz		24.4		dB
	f = 1.9 GHz		23.9		dB
	f = 2.7 GHz		13.5		dB
RF OUTPUT INTERFACE					
Output Compression Point	Pin VOUT				
	f = 900 MHz		4.8		dBm
	f = 1.9 GHz		4.6		dBm
	f = 2.7 GHz		3.6		dBm
Delta Compression Point	f = 900 MHz, $-40^\circ\text{C} \leq T_A \leq +85^\circ\text{C}$		0.37		dB
	f = 1.9 GHz, $-40^\circ\text{C} \leq T_A \leq +85^\circ\text{C}$		-0.14		dB
	f = 2.7 GHz, $-40^\circ\text{C} \leq T_A \leq +85^\circ\text{C}$		-0.05		dB
Output Return Loss	f = 900 MHz		23.7		dB
	f = 1.9 GHz		22.5		dB
	f = 2.7 GHz		17.6		dB
DISTORTION/NOISE					
Output Third-Order Intercept	f = 900 MHz, $\Delta f = 50\text{ MHz}$, $P_{IN} = -30\text{ dBm}$		19.3		dBm
	f = 1.9 GHz, $\Delta f = 50\text{ MHz}$, $P_{IN} = -30\text{ dBm}$		17.3		dBm
	f = 2.7 GHz, $\Delta f = 50\text{ MHz}$, $P_{IN} = -30\text{ dBm}$		15.3		dBm
Output Second-Order Intercept	f = 900 MHz, $\Delta f = 1\text{ MHz}$, $P_{IN} = -28\text{ dBm}$		28.7		dBm
Noise Figure	f = 900 MHz		4.4		dB
	f = 1.9 GHz		5		dB
	f = 2.7 GHz		5.6		dB
POWER INTERFACE					
Supply Voltage	Pin VPOS	4.5	5	5.5	V
Total Supply Current	$T_A = 27^\circ\text{C}$	17	25	34	mA
Supply Voltage Sensitivity			4		mA/V
Temperature Sensitivity	$-40^\circ\text{C} \leq T_A \leq +85^\circ\text{C}$		28		$\mu\text{A}/^\circ\text{C}$

ABSOLUTE MAXIMUM RATINGS

Table 3.

Parameter	Rating
Supply Voltage, VPOS	5.5 V
Input Power (re: 50 Ω)	10 dBm
Equivalent Voltage	700 mV rms
Internal Power Dissipation	
Paddle Not Soldered	325 mW
Paddle Soldered	812 mW
θ_{JA} (Paddle Soldered)	80°C/W
θ_{JA} (Paddle Not Soldered)	200°C/W
Maximum Junction Temperature	150°C
Operating Temperature Range	-40°C to +85°C
Storage Temperature Range	-65°C to +150°C
Lead Temperature (Soldering, 60 sec)	
AD8354ACP (Non-RoHS Compliant)	240°C
AD8354ACPZ (RoHS Compliant)	260°C

Stresses at or above those listed under Absolute Maximum Ratings may cause permanent damage to the product. This is a stress rating only; functional operation of the product at these or any other conditions above those indicated in the operational section of this specification is not implied. Operation beyond the maximum operating conditions for extended periods may affect product reliability.

ESD CAUTION



ESD (electrostatic discharge) sensitive device. Charged devices and circuit boards can discharge without detection. Although this product features patented or proprietary protection circuitry, damage may occur on devices subjected to high energy ESD. Therefore, proper ESD precautions should be taken to avoid performance degradation or loss of functionality.

PIN CONFIGURATION AND FUNCTION DESCRIPTIONS

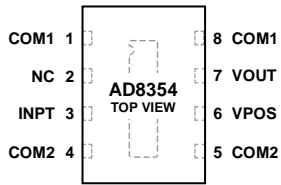

- NOTES
1. NC = NO CONNECT.
 2. THE EXPOSEDPAD MUST BE CONNECTED TO A LOW IMPEDANCE GROUND PAD.

02722-041

Figure 2. Pin Configuration

Table 4. Pin Function Descriptions

Pin No.	Mnemonic	Description
1, 8	COM1	Device Common. Connect to low impedance ground.
2	NC	No Connection.
3	INPT	RF Input Connection. Must be ac-coupled.
4, 5	COM2	Device Common. Connect to low impedance ground.
6	VPOS	Positive Supply Voltage.
7	VOU	RF Output Connection. Must be ac-coupled.

TYPICAL PERFORMANCE CHARACTERISTICS

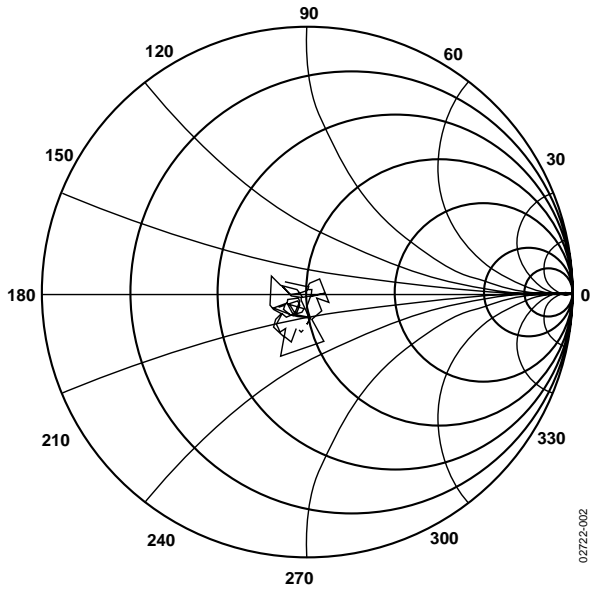

Figure 3. S_{11} vs. Frequency, $V_S = 3\text{ V}$, $T_A = 25^\circ\text{C}$, $100\text{ MHz} \leq f \leq 3\text{ GHz}$

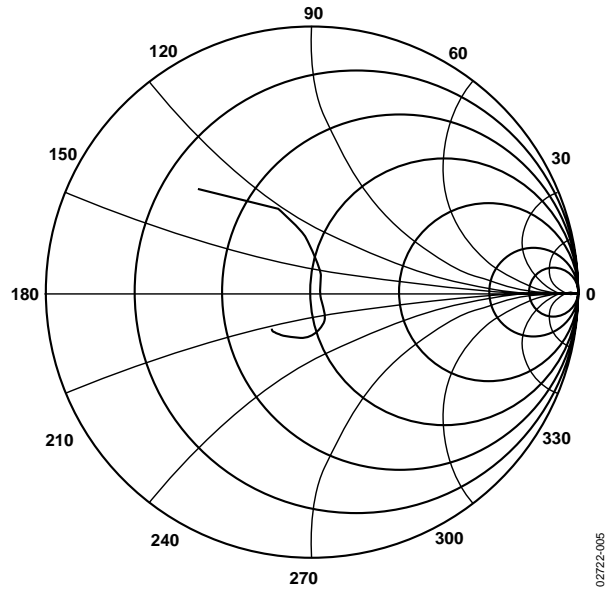

Figure 6. S_{22} vs. Frequency, $V_S = 3\text{ V}$, $T_A = 25^\circ\text{C}$, $100\text{ MHz} \leq f \leq 3\text{ GHz}$

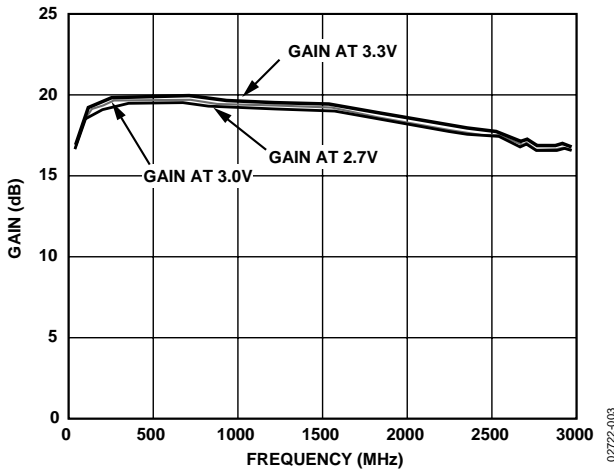

Figure 4. Gain vs. Frequency, $V_S = 2.7\text{ V}$, 3 V , and 3.3 V , $T_A = 25^\circ\text{C}$

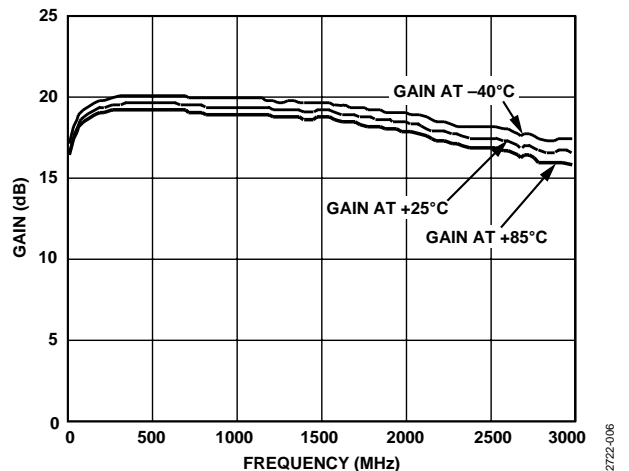

Figure 7. Gain vs. Frequency, $V_S = 3\text{ V}$, $T_A = -40^\circ\text{C}$, $+25^\circ\text{C}$, and $+85^\circ\text{C}$

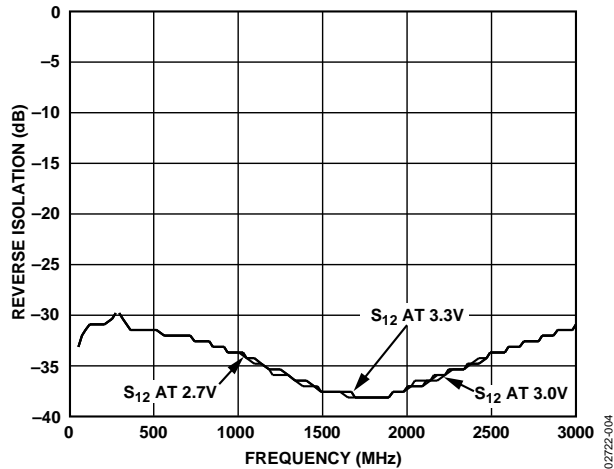

Figure 5. Reverse Isolation vs. Frequency, $V_S = 2.7\text{ V}$, 3 V , and 3.3 V , $T_A = 25^\circ\text{C}$

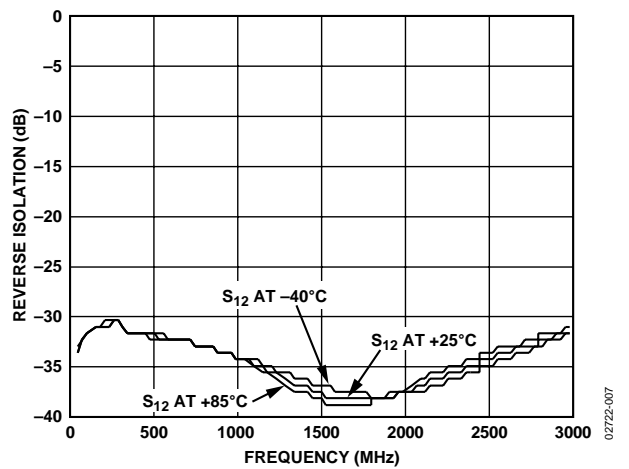

Figure 8. Reverse Isolation vs. Frequency, $V_S = 3\text{ V}$, $T_A = -40^\circ\text{C}$, $+25^\circ\text{C}$, and $+85^\circ\text{C}$

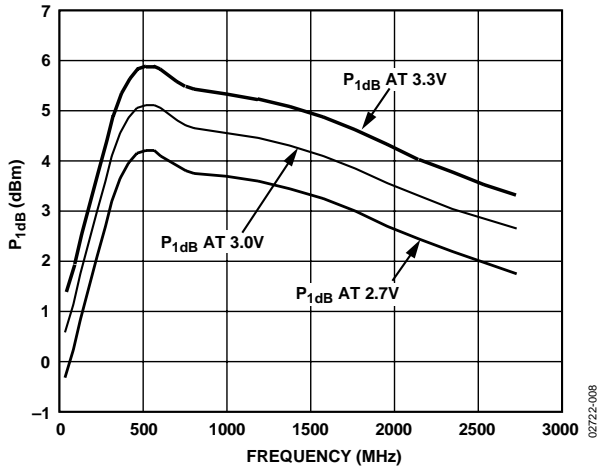

Figure 9. P_{1dB} vs. Frequency, $V_S = 2.7\text{ V}$, 3 V , and 3.3 V , $T_A = 25^\circ\text{C}$

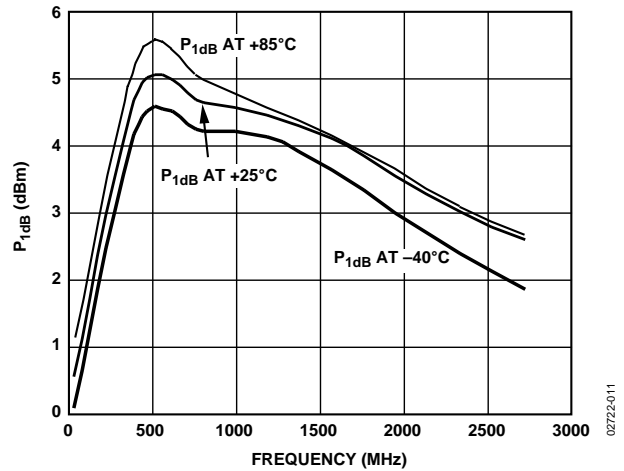

Figure 12. P_{1dB} vs. Frequency, $V_S = 3\text{ V}$, $T_A = -40^\circ\text{C}$, $+25^\circ\text{C}$, and $+85^\circ\text{C}$

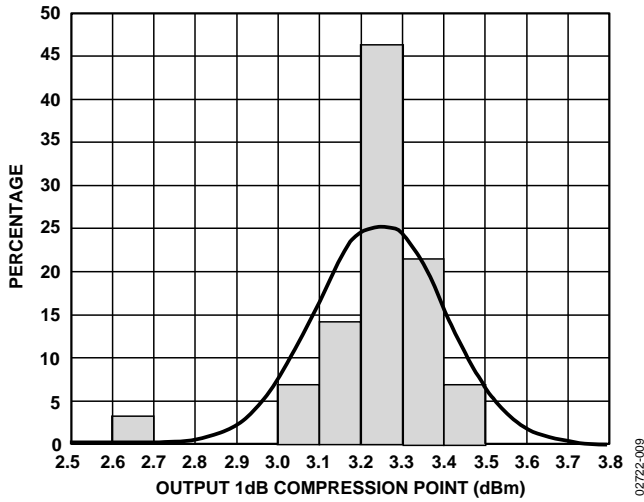

Figure 10. Distribution of P_{1dB} , $V_S = 3\text{ V}$, $T_A = 25^\circ\text{C}$, $f = 2.2\text{ GHz}$

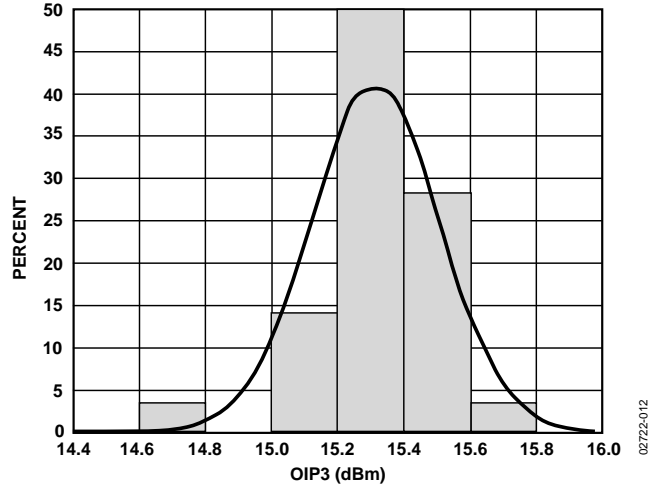

Figure 13. Distribution of $OIP3$, $V_S = 3\text{ V}$, $T_A = 25^\circ\text{C}$, $f = 2.2\text{ GHz}$

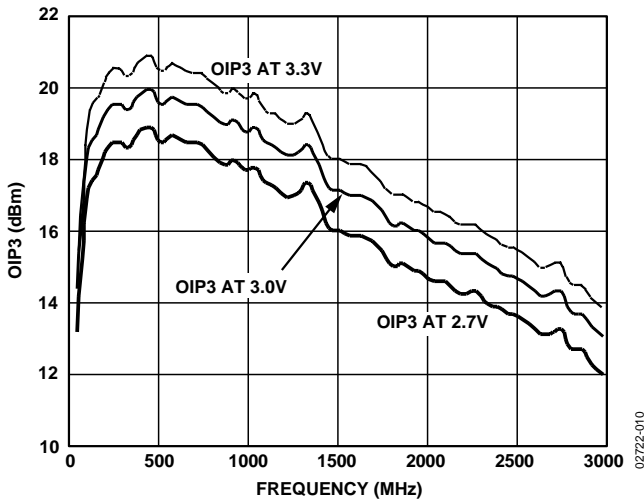

Figure 11. $OIP3$ vs. Frequency, $V_S = 2.7\text{ V}$, 3 V , and 3.3 V , $T_A = 25^\circ\text{C}$

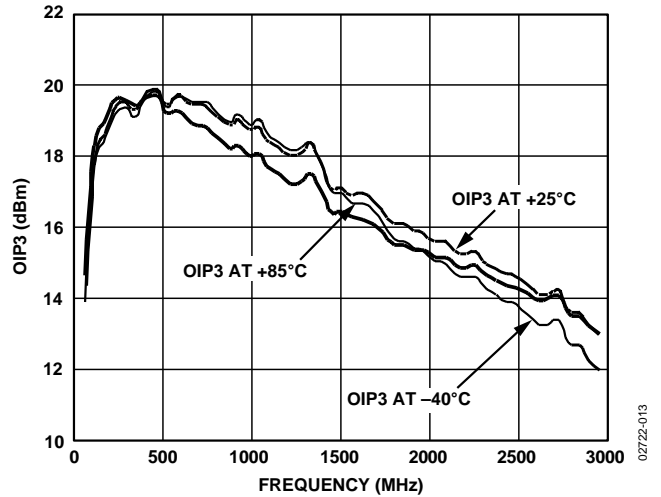

Figure 14. $OIP3$ vs. Frequency, $V_S = 3\text{ V}$, $T_A = -40^\circ\text{C}$, $+25^\circ\text{C}$, and $+85^\circ\text{C}$

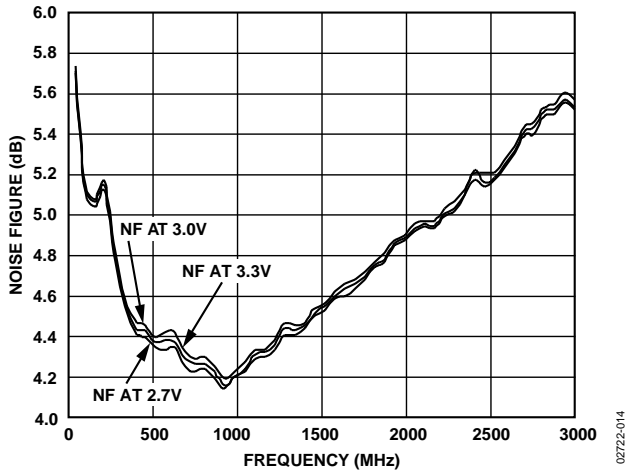

Figure 15. Noise Figure vs. Frequency, $V_S = 2.7\text{ V}, 3\text{ V}, \text{ and } 3.3\text{ V}, T_A = 25^\circ\text{C}$

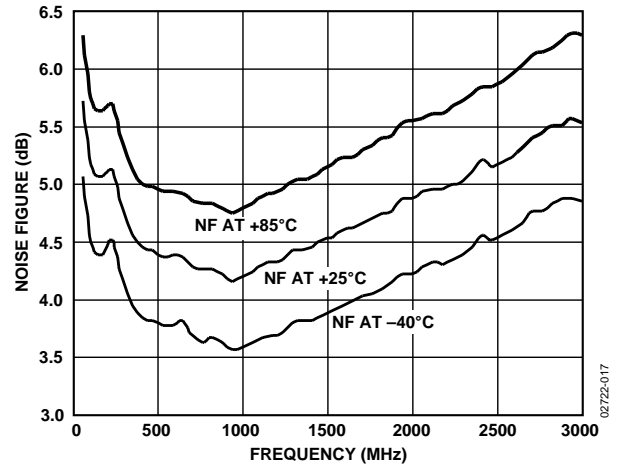

Figure 18. Noise Figure vs. Frequency, $V_S = 3\text{ V}, T_A = -40^\circ\text{C}, +25^\circ\text{C}, \text{ and } +85^\circ\text{C}$

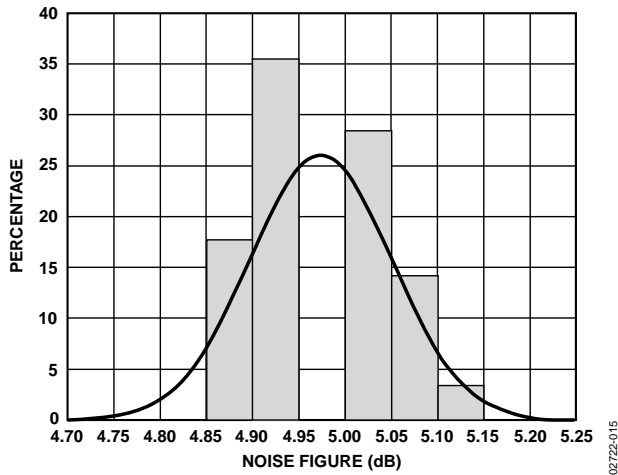

Figure 16. Distribution of Noise Figure, $V_S = 3\text{ V}, T_A = 25^\circ\text{C}, f = 2.2\text{ GHz}$

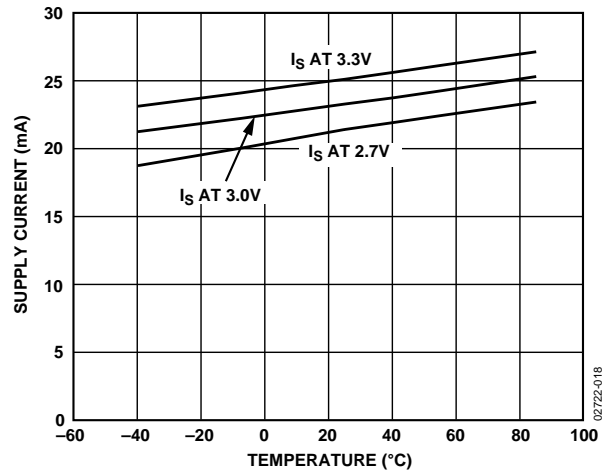

Figure 19. Supply Current vs. Temperature, $V_S = 2.7\text{ V}, 3\text{ V}, \text{ and } 3.3\text{ V}$

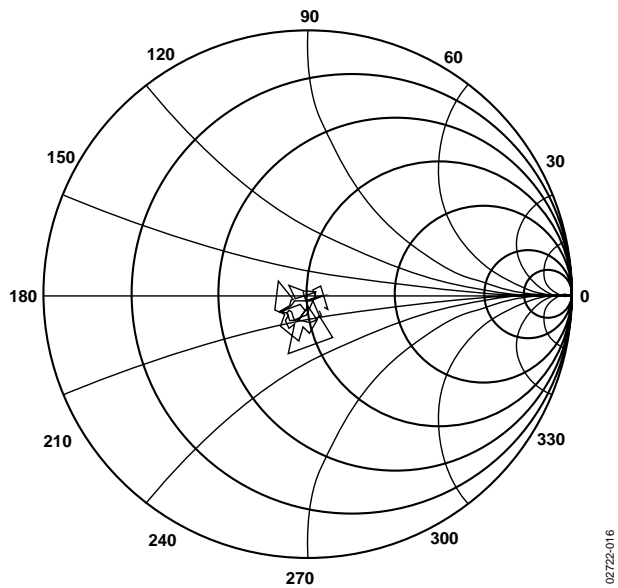

Figure 17. S_{11} vs. Frequency, $V_S = 5\text{ V}, T_A = 25^\circ\text{C}, 100\text{ MHz} \leq f \leq 3\text{ GHz}$

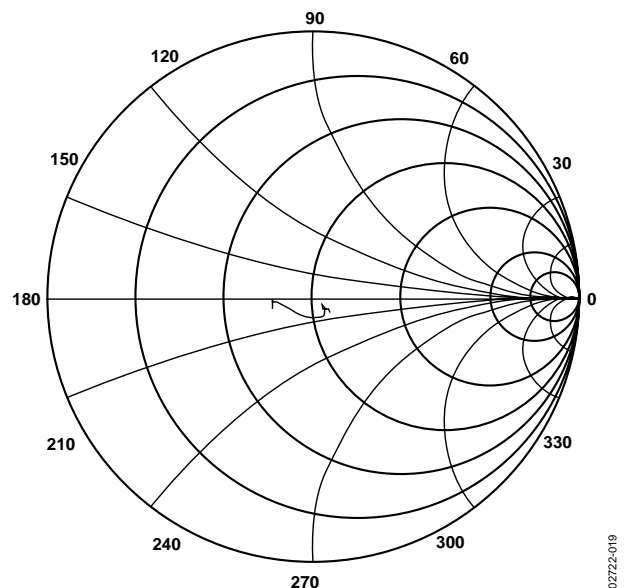

Figure 20. S_{22} vs. Frequency, $V_S = 5\text{ V}, T_A = 25^\circ\text{C}, 100\text{ MHz} \leq f \leq 3\text{ GHz}$

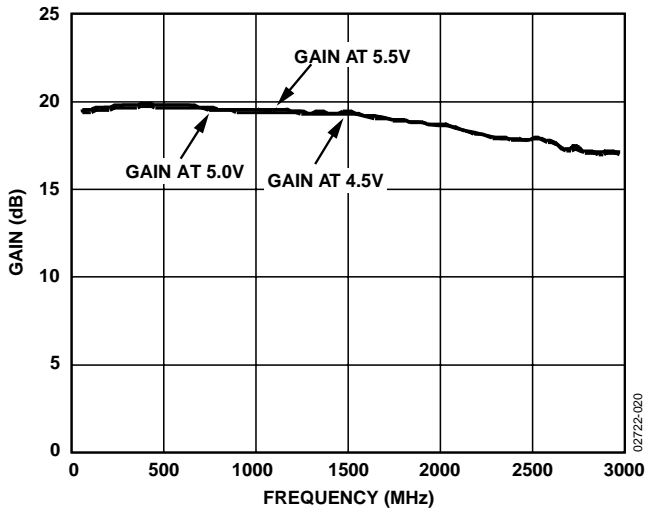

Figure 21. Gain vs. Frequency, $V_S = 4.5\text{ V}, 5\text{ V}, \text{ and } 5.5\text{ V}, T_A = 25^\circ\text{C}$

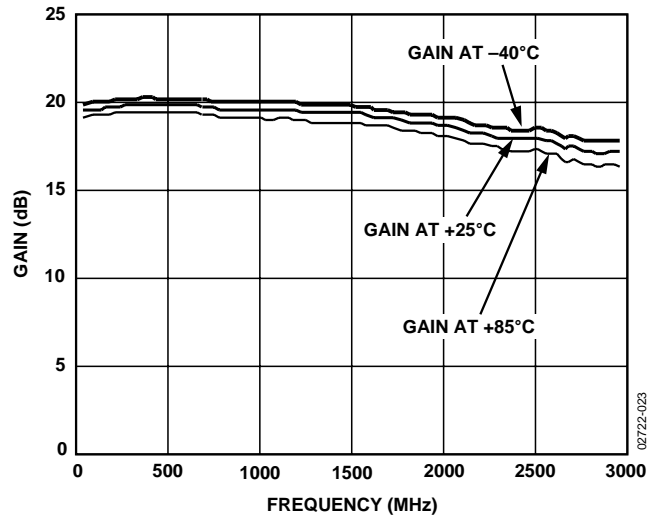

Figure 24. Gain vs. Frequency, $V_S = 5\text{ V}, T_A = -40^\circ\text{C}, +25^\circ\text{C}, \text{ and } +85^\circ\text{C}$

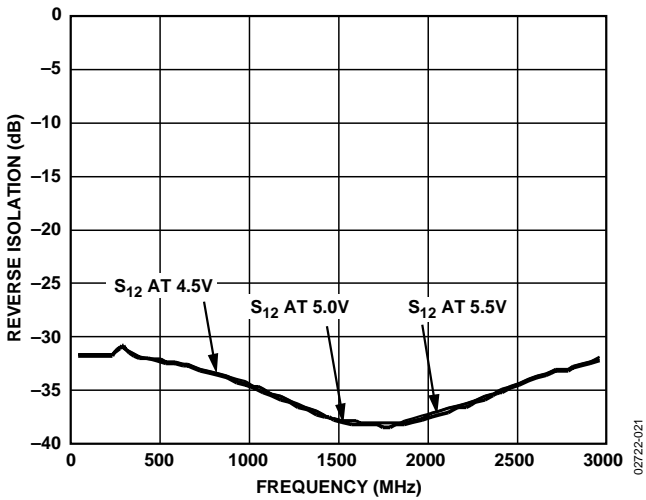

Figure 22. Reverse Isolation vs. Frequency, $V_S = 4.5\text{ V}, 5\text{ V}, \text{ and } 5.5\text{ V}, T_A = 25^\circ\text{C}$

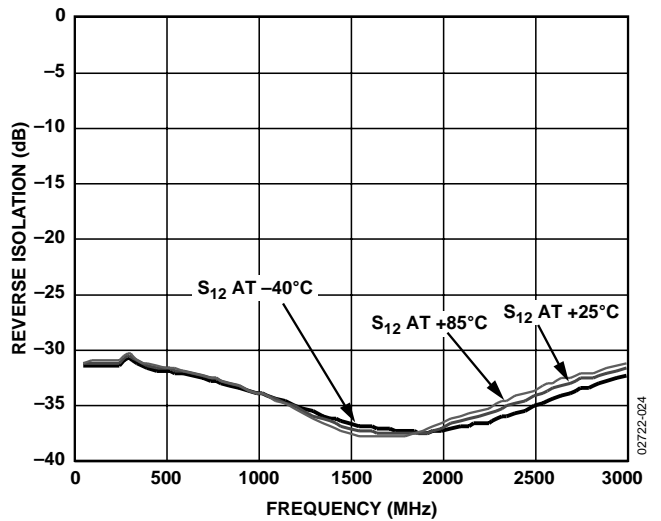

Figure 25. Reverse Isolation vs. Frequency, $V_S = 5\text{ V}, T_A = -40^\circ\text{C}, +25^\circ\text{C}, \text{ and } +85^\circ\text{C}$

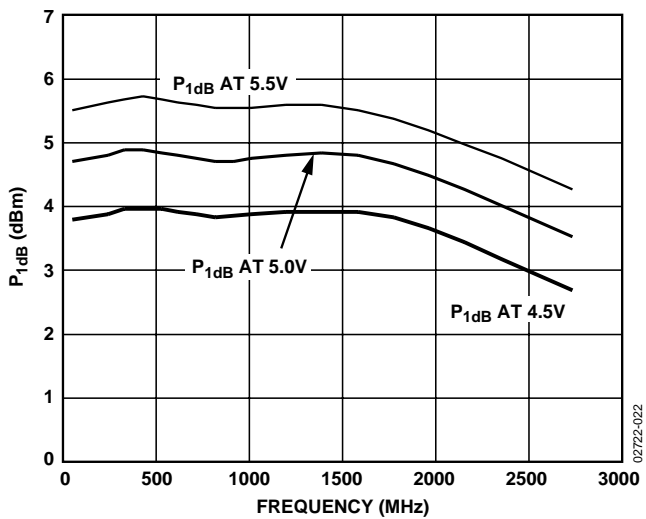

Figure 23. P_{1dB} vs. Frequency, $V_S = 4.5\text{ V}, 5\text{ V}, \text{ and } 5.5\text{ V}, T_A = 25^\circ\text{C}$

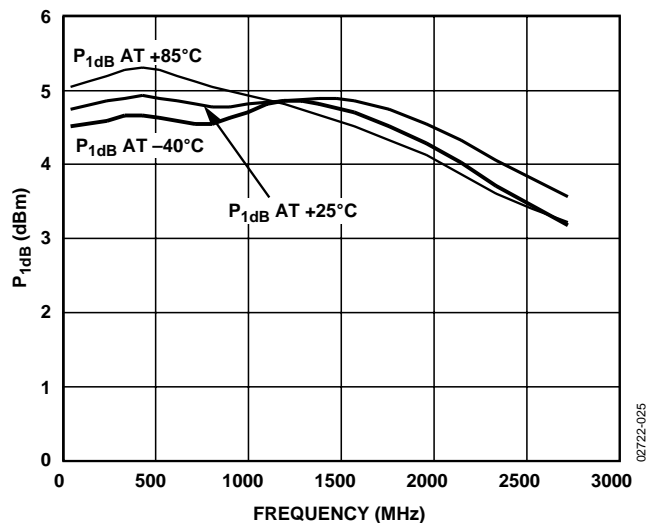

Figure 26. P_{1dB} vs. Frequency, $V_S = 5\text{ V}, T_A = -40^\circ\text{C}, +25^\circ\text{C}, \text{ and } +85^\circ\text{C}$

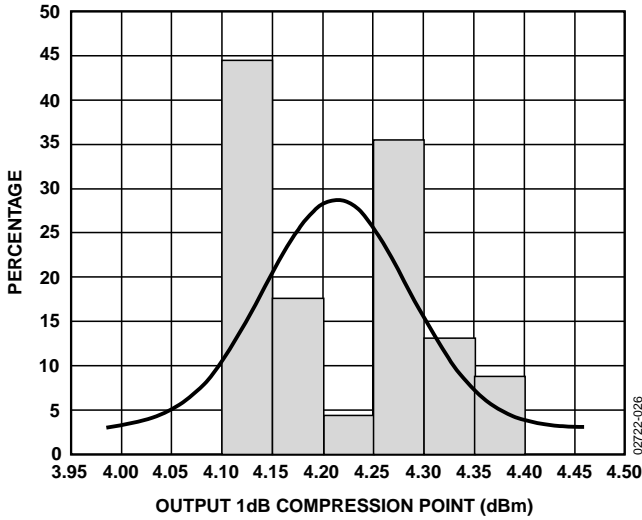

Figure 27. Distribution of P_{1dB} , $V_S = 5\text{ V}$, $T_A = 25^\circ\text{C}$, $f = 2.2\text{ GHz}$

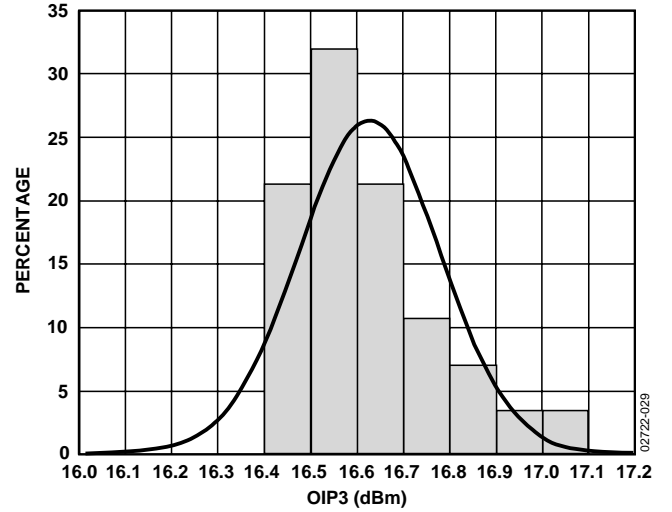

Figure 30. Distribution of OIP3, $V_S = 5\text{ V}$, $T_A = 25^\circ\text{C}$, $f = 2.2\text{ GHz}$

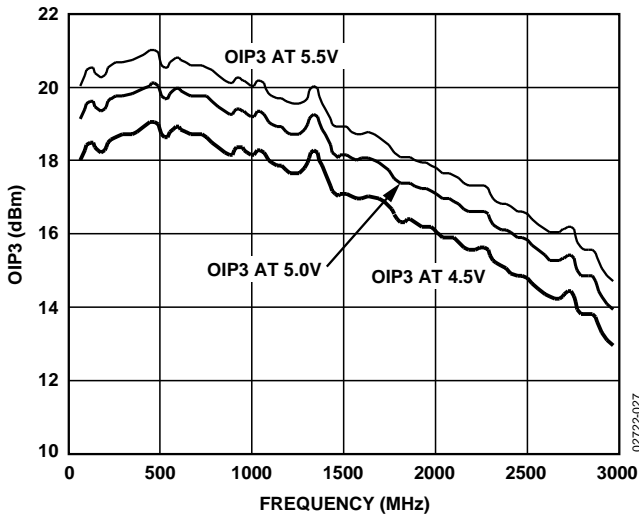

Figure 28. OIP3 vs. Frequency, $V_S = 4.5\text{ V}$, 5 V , and 5.5 V , $T_A = 25^\circ\text{C}$

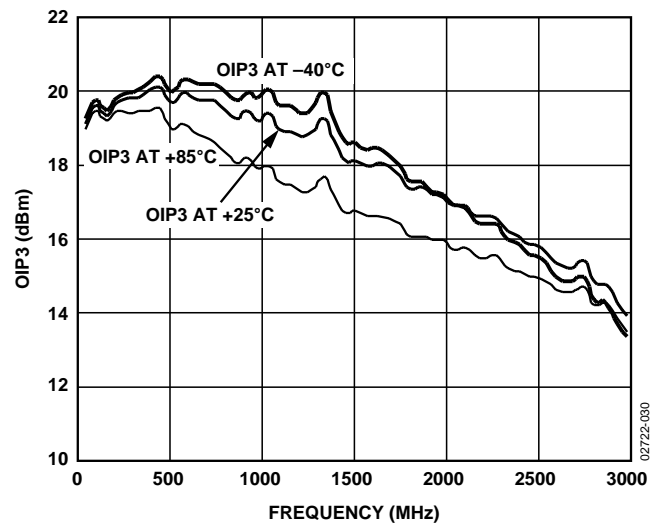

Figure 31. OIP3 vs. Frequency, $V_S = 5\text{ V}$, $T_A = -40^\circ\text{C}$, $+25^\circ\text{C}$, and $+85^\circ\text{C}$

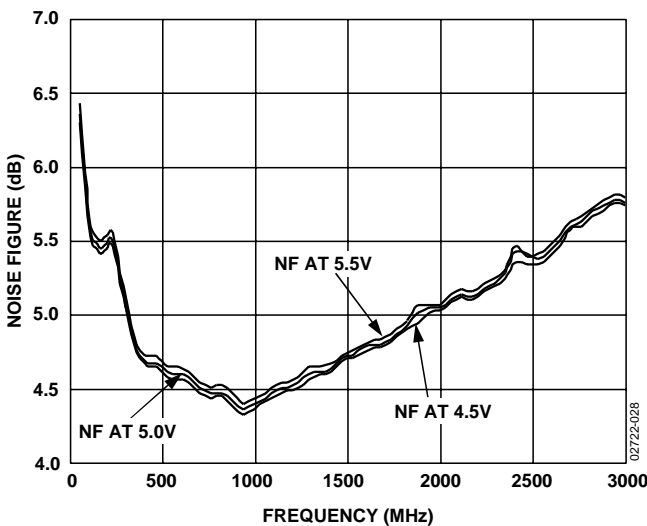

Figure 29. Noise Figure vs. Frequency, $V_S = 4.5\text{ V}$, 5 V , and 5.5 V , $T_A = 25^\circ\text{C}$

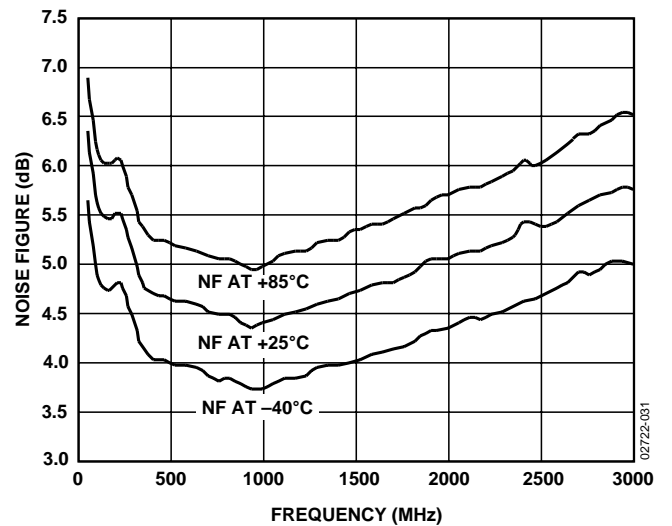

Figure 32. Noise Figure vs. Frequency, $V_S = 5\text{ V}$, $T_A = -40^\circ\text{C}$, $+25^\circ\text{C}$, and $+85^\circ\text{C}$

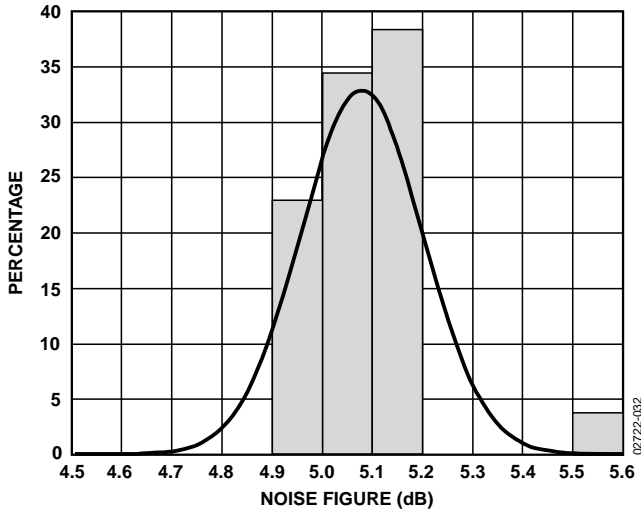

Figure 33. Distribution of Noise Figure, $V_S = 5\text{ V}$, $T_A = 25^\circ\text{C}$, $f = 2.2\text{ GHz}$

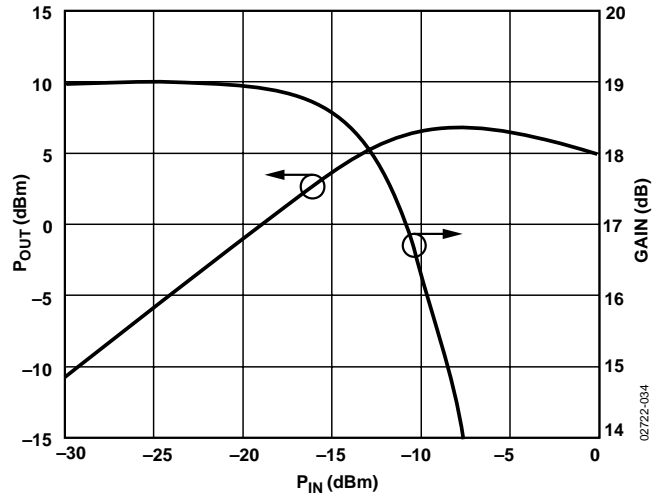

Figure 36. Output Power and Gain vs. Input Power, $V_S = 3\text{ V}$, $T_A = 25^\circ\text{C}$, $f = 900\text{ MHz}$

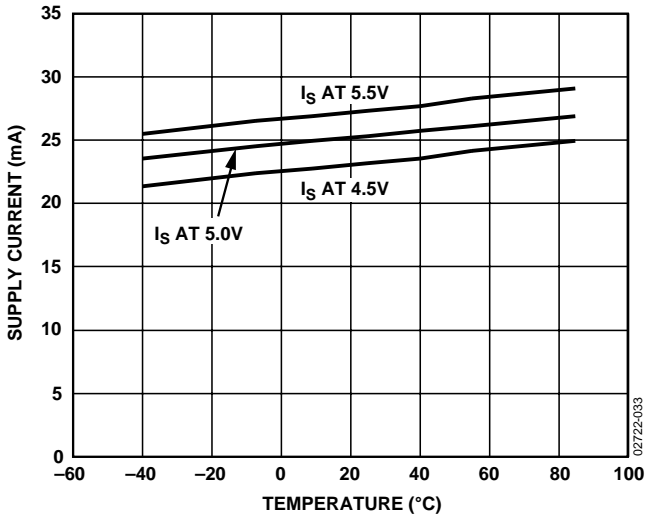

Figure 34. Supply Current vs. Temperature, $V_S = 4.5\text{ V}$, 5 V , and 5.5 V

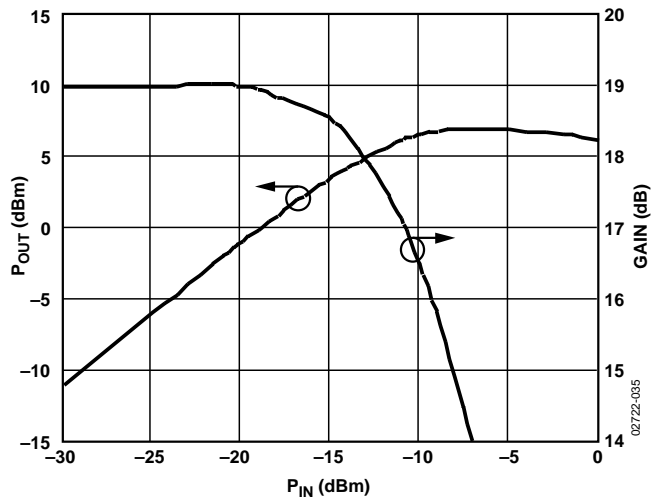

Figure 37. Output Power and Gain vs. Input Power, $V_S = 5\text{ V}$, $T_A = 25^\circ\text{C}$, $f = 900\text{ MHz}$

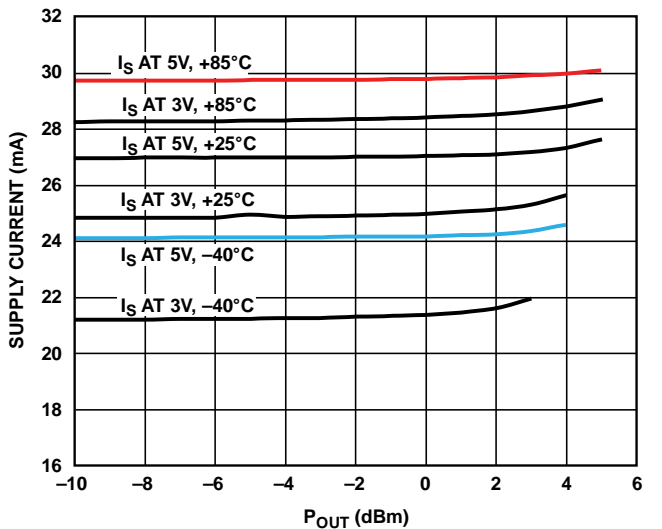

Figure 35. Supply Current vs. P_{OUT} and Temperature, $V_S = 5\text{ V}$

THEORY OF OPERATION

The AD8354 is a 2-stage, feedback amplifier employing both shunt-series and shunt-shunt feedback. The first stage is degenerated and resistively loaded and provides approximately 10 dB of gain. The second stage is a PNP-NPN Darlington output stage, which provides another 10 dB of gain. Series-shunt feedback from the emitter of the output transistor sets the input impedance to 50 Ω over a broad frequency range. Shunt-shunt feedback from the amplifier output to the input of the Darlington stage helps to set the output impedance to 50 Ω . The amplifier can be operated from a 3 V supply by adding a choke inductor from the amplifier output to VPOS. Without this choke inductor, operation from a 5 V supply is also possible.

BASIC CONNECTIONS

The AD8354 RF gain block is a fixed gain amplifier with single-ended input and output ports whose impedances are nominally equal to 50 Ω over the frequency range 1 MHz to 2.7 GHz. Consequently, it can be directly inserted into a 50 Ω system with no impedance matching circuitry required. The input and output impedances are sufficiently stable vs. variations in temperature and supply voltage that no impedance matching compensation is required. A complete set of scattering parameters is available at www.analog.com.

The input pin (INPT) is connected directly to the base of the first amplifier stage, which is internally biased to approximately 1 V; therefore, a dc blocking capacitor should be connected between the source that drives the AD8354 and the input pin, INPT.

It is critical to supply very low inductance ground connections to the ground pins (Pin 1, Pin 4, Pin 5, and Pin 8) as well as to the backside exposed paddle. This ensures stable operation.

The AD8354 is designed to operate over a wide supply voltage range, from 2.7 V to 5.5 V. The output of the part, VOUT, is taken directly from the collector of the output amplifier stage. This node is internally biased to approximately 3.2 V when the supply voltage is 5 V. Consequently, a dc blocking capacitor should be connected between the output pin, VOUT, and the load that it drives. The value of this capacitor is not critical, but it should be 100 pF or larger.

When the supply voltage is 3 V, it is recommended that an external RF choke be connected between the supply voltage and the output pin, VOUT. This increases the dc voltage applied to the collector of the output amplifier stage, which improves performance of the AD8354 to be very similar to the performance produced when 5 V is used for the supply voltage. The inductance of the RF choke should be approximately 100 nH, and care should be taken to ensure that the lowest series self-resonant frequency of this choke is well above the maximum frequency of operation for the AD8354.

Bypass the supply voltage input, VPOS, using a large value capacitance (approximately 0.47 μ F or larger) and a smaller, high frequency bypass capacitor (approximately 100 pF) physically located close to the VPOS pin.

The recommended connections and components are shown in Figure 41.

APPLICATIONS INFORMATION

The AD8354 RF gain block can be used as a general-purpose, fixed gain amplifier in a wide variety of applications, such as a driver for a transmitter power amplifier (see Figure 38). Its excellent reverse isolation also makes this amplifier suitable for use as a local oscillator buffer amplifier that would drive the local oscillator port of an upconverter or downconverter mixer (see Figure 39).

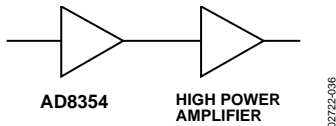

Figure 38. AD8354 as a Driver Amplifier

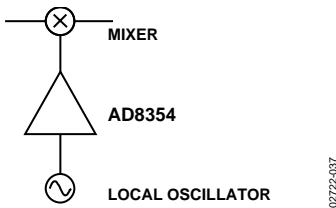

Figure 39. AD8354 as a LO Driver Amplifier

LOW FREQUENCY APPLICATIONS BELOW 100 MHz

The AD8354 RF gain block can be used below 100 MHz. To accomplish this, the series dc blocking capacitors, C1 and C2, need to be changed to a higher value that is appropriate for the desired frequency. C1 and C2 were changed to 0.1 μF to accomplish the sweeps in Figure 40.

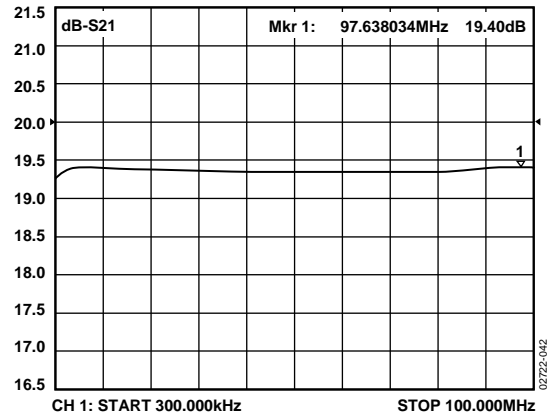

Figure 40. Low Frequency Application from 300 kHz to 100 MHz at 5 V VPOS, -12 dBm Input Power

EVALUATION BOARD

Figure 41 shows the schematic of the AD8354 evaluation board. Note that L1 is shown as an optional component that is used to obtain maximum gain only when $V_P = 3$ V. The board is powered by a single supply in the 2.7 V to 5.5 V range. The power supply is decoupled by a 0.47 μ F and a 100 pF capacitor.

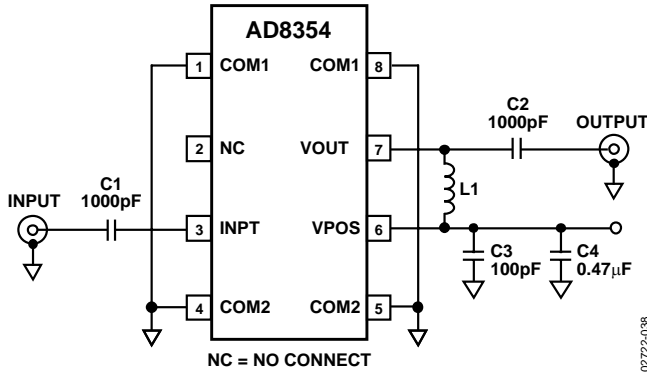

Figure 41. Evaluation Board Schematic

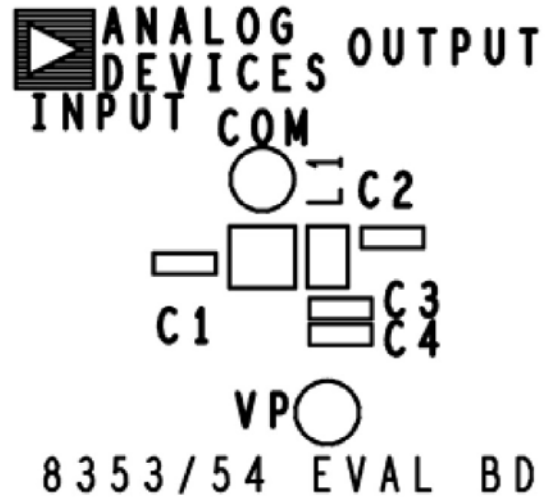

Figure 42. Silkscreen Top

Table 5. Evaluation Board Configuration Options

Component	Function	Default Value
C1, C2	AC coupling capacitors.	1000 pF, 0603
C3	High frequency bypass capacitor.	100 pF, 0603
C4	Low frequency bypass capacitor.	0.47 μ F, 0603
L1	Optional RF choke, used to increase current through output stage when $V_P = 3$ V. Not recommended for use when $V_P = 5$ V.	100 nH, 0603

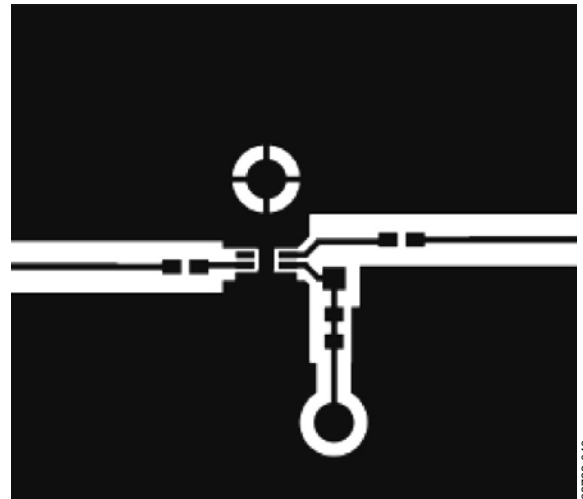

Figure 43. Component Side

OUTLINE DIMENSIONS

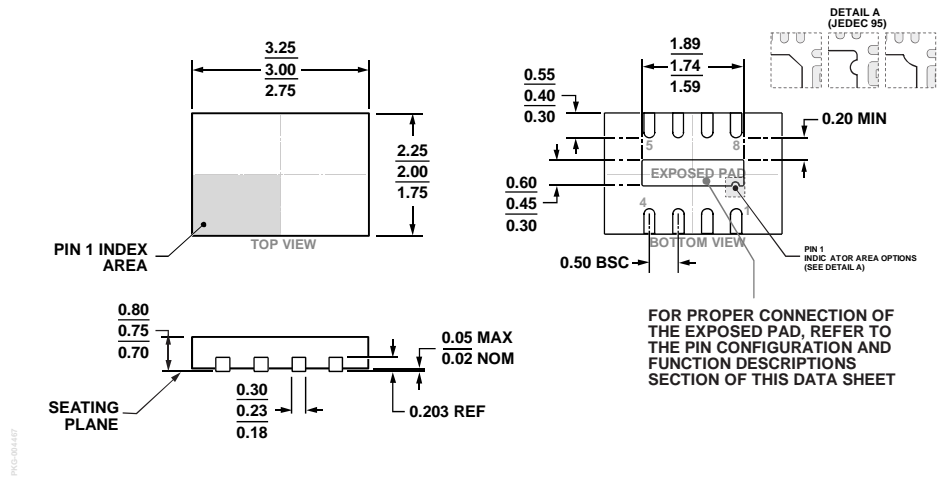

Figure 44. 8-Lead Lead Frame Chip Scale Package [LFCS]
 2 mm × 3 mm Body and 0.75 mm Package Height
 (CP-8-23)
 Dimensions shown in millimeters

ORDERING GUIDE

Model ¹	Temperature Range	Package Description	Package Option	Branding
AD8354ACPZ-REEL7	-40°C to +85°C	8-Lead LFCS, 7" Tape and Reel	CP-8-23	0G
AD8354-EVALZ		Evaluation Board		

¹ Z = RoHS Compliant Part.

Компания «Life Electronics» занимается поставками электронных компонентов импортного и отечественного производства от производителей и со складов крупных дистрибьюторов Европы, Америки и Азии.

С конца 2013 года компания активно расширяет линейку поставок компонентов по направлению коаксиальный кабель, кварцевые генераторы и конденсаторы (керамические, пленочные, электролитические), за счёт заключения дистрибьюторских договоров

Мы предлагаем:

- Конкурентоспособные цены и скидки постоянным клиентам.
- Специальные условия для постоянных клиентов.
- Подбор аналогов.
- Поставку компонентов в любых объемах, удовлетворяющих вашим потребностям.
- Приемлемые сроки поставки, возможна ускоренная поставка.
- Доставку товара в любую точку России и стран СНГ.
- Комплексную поставку.
- Работу по проектам и поставку образцов.
- Формирование склада под заказчика.
- Сертификаты соответствия на поставляемую продукцию (по желанию клиента).
- Тестирование поставляемой продукции.
- Поставку компонентов, требующих военную и космическую приемку.
- Входной контроль качества.
- Наличие сертификата ISO.

В составе нашей компании организован Конструкторский отдел, призванный помогать разработчикам, и инженерам.

Конструкторский отдел помогает осуществить:

- Регистрацию проекта у производителя компонентов.
- Техническую поддержку проекта.
- Защиту от снятия компонента с производства.
- Оценку стоимости проекта по компонентам.
- Изготовление тестовой платы монтаж и пусконаладочные работы.



Тел: +7 (812) 336 43 04 (многоканальный)

Email: org@lifeelectronics.ru