

ETD-FL-2T-DTI

Multifunctional timer relay with two adjustable times



INTERFACE

Data sheet
102570_en_04

© PHOENIX CONTACT - 09/2009

1 Description

Increasingly higher demands are being placed on safety and system availability – across all sectors. Processes are becoming more and more complex, not only in mechanical engineering and the chemical industry, but also in plant and automation technology. Demands on power engineering are also increasing constantly.

The timer relays in the ETD series can be used to control time sequences in production and process technology.

Features

- Two adjustable times
- Time range of 50 ms to 10 hours (ten setting ranges)
- Electrically isolated control input
- Time set via remote potentiometers
- Timer function
- Wiper functions
- Delay functions
- Pulse sequence evaluation
- Wide-range power supply unit
- Two floating PDTs



WARNING: Risk of electric shock

Never carry out work when voltage is present.



Make sure you always use the the latest documentation.
It can be downloaded at www.phoenixcontact.net/download.

2 Ordering data

Description	Type	Order No.	Pcs. / Pkt.
Multifunctional timer relay with two adjustable times	ETD-FL-2T-DTI	2866187	1

3 Technical data

Input data	
Input voltage range	24 V DC ... 240 V DC -20 % ... +25 % 24 V AC ... 240 V AC -15 % ... +10 %
Nominal frequency	48 Hz ... 400 Hz
Temperature coefficient, typical	≤ 0.01 %/K
Recovery time	500 ms
Time setting range	50 ms ... 10 h (10 time end ranges)
Function	Ip: Switched-mode beginning with the pause Ii: Switched-mode beginning with the pulse ER: With switch-on and release delay with control contact EWu: With switch-on delay and single shot leading edge, voltage controlled EWs: With switch-on delay and single shot leading edge with control contact WsWa: With single shot leading edge and single shot trailing edge with control contact Wt: Pulse sequence evaluation (retriggerable release delay)
Basic accuracy	± 1 % (With 1 MΩ remote potentiometer, from scale end value)
Setting accuracy	≤ 5 % (With 1 MΩ remote potentiometer, from scale end value)
Repeat accuracy	≤ 0.5 % ±5 ms
Nominal power consumption	2.5 VA (1 W)
Output data	
Contact type	2 floating PDT contacts
Nominal insulation voltage	250 V AC (in acc. with IEC 60664-1)
Interrupting rating (ohmic load) max.	750 VA (3 A/250 V AC, module aligned, ≤ 5 mm spacing) 1250 VA (5 A/250 V AC, module not aligned, ≥ 5 mm spacing)
Output fuse	5 A (fast-blow)
Control contact	
Control contact	Floating, basic isolation between connection and input/output/bridge Y1-Y2
Load capacity	Cannot carry load
Cable length	max. 10 m
Control pulse length	min. 50 ms (Only with Wt function: > 7 ms)
Maximum control voltage	5 V
Maximum short-circuit current	1 mA
General data	
Service life mechanical	Approx. 2×10^7 cycles
Service life, electrical	Approx. 2×10^5 cycles at ohmic load, 1000 VA
Switching frequency	max. 60 (per minute at 100 VA ohmic load) max. 6 (per minute at 1000 VA ohmic load)
Operating mode	100% operating factor
Degree of protection	IP40 (housing) / IP20 (connection terminal blocks)
Pollution degree	2 (according to EN 50178)
Surge voltage category	III, basic insulation (as per EN 50178)
Rated insulation voltage	300 V (According to EN 50178)

General data (Continued)

Inflammability class acc. to UL 94	V0
Assembly	on TS 35 profile rail acc. to EN 60715
Mounting position	Any
Width	22.5 mm
Height	113 mm
Length	90 mm
Type of housing	Polyamide PA, self-extinguishing
Color	green
Weight	160 g

Remote potentiometer

Terminal resistance	1 M Ω (E.g., Rondo RZ type)
Cable type	Twisted cable or twin cable
Control voltage	max. 5 V
Short circuit current	max. 5 μ A
Note:	Cable length 5 m, maximum

Connection data

Conductor cross section, solid	0.5 mm ² ... 2.5 mm ²
Conductor cross section, stranded	0.5 mm ² ... 2.5 mm ²
Stripping length	8 mm
Type of connection	Screw connection
Tightening torque	1 Nm

Ambient conditions

Ambient temperature (operation)	-25 °C ... 55 °C -25 °C ... 40 °C (corresponds to UL 508)
Ambient temperature (storage/transport)	-25 °C ... 70 °C
Permissible humidity (operation)	15 % ... 85 %
Climatic class	3K3 (in acc. with EN 60721)

Conformance / approvals

Conformity	CE compliant
UL, USA / Canada	UL/C-UL listed UL 508

Conformance with EMC directive 2004/108/EC

Immunity to interference according to	EN 61000-6-2
Emitted interference according to	EN 61000-6-4

Conformance with LV directive 2006/95/EC

Industrial timer relays according to	EN 61812-1/A11
--------------------------------------	----------------

4 Block diagram

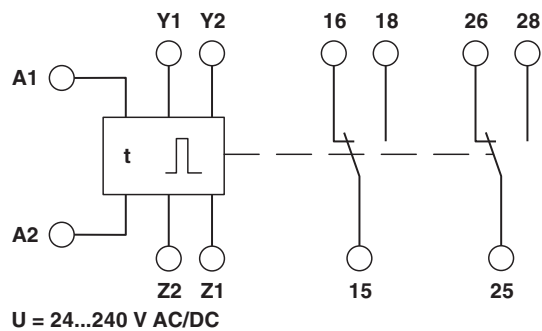

5 Safety notes



WARNING: Risk of electric shock

Never carry out work when voltage is present.

6 Structure

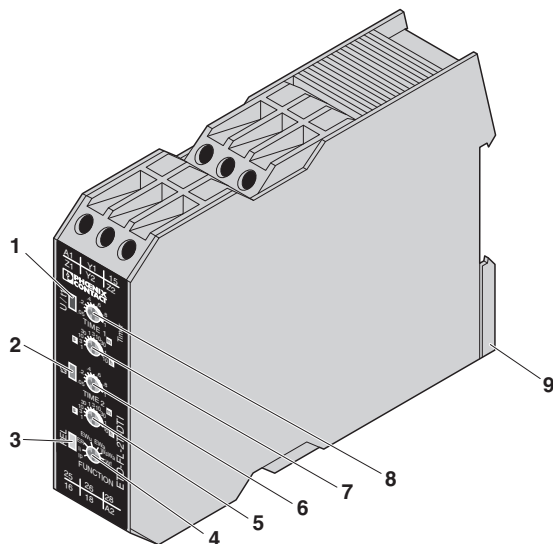

- 1 "U/t1" LED: Supply and adjustable time t1
- 2 "t2" LED: Adjustable time t2
- 3 "REL" LED: Output relay
- 4 "FUNCTION" rotary switch: Function selection
- 5 Rotary switch "TIME2": Time end range
- 6 "TIME2" potentiometer: Preset value
- 7 Rotary switch "TIME1": Time end range
- 8 "TIME1" potentiometer: Preset value
- 9 Universal snap-on foot for EN DIN rails

7 Installation



WARNING: Risk of electric shock

Never carry out work when voltage is present.

The module can be snapped onto all 35 mm DIN rails according to EN 60715.

An integrated wide-range power supply unit enables the connection of a supply voltage in the range from 24 V AC/DC to 240 V AC/DC.

8 Time setting

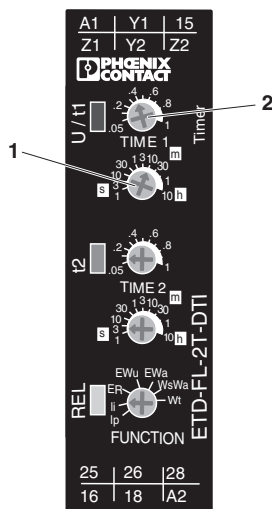

Example:

- 1 Specification of the time end range using a rotary switch, e.g. 10 m (10 minutes)
- 2 Fine setting of the time using a potentiometer, e.g. 0.4

Set time: 0.4 * 10 minutes = 4 minutes

9 Diagnostics

The LEDs indicate the following error states:

"U/t1" LED (Green)

- LED flashes: Voltage present, set time running
- LED ON: Voltage present, set time has elapsed

"t2" LED (Green)

- LED flashes: Voltage present, set time running
- LED OFF: Time has elapsed

"REL" LED (Yellow)

- LED ON: Output relay has picked up
- LED OFF: Output relay has dropped out

10 Connection examples



ATTENTION

If a remote potentiometer is connected, the internal potentiometer is deactivated.

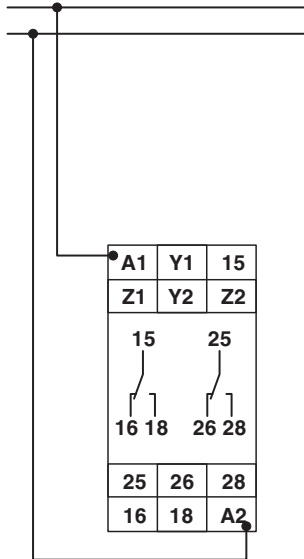

Connection without control contact

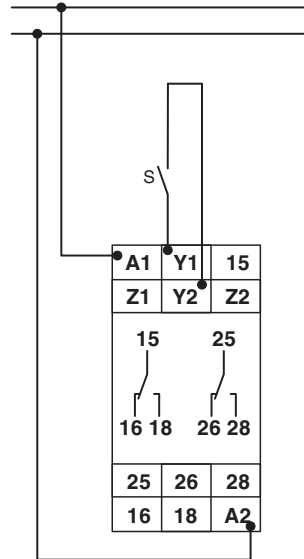

Connection with control contact

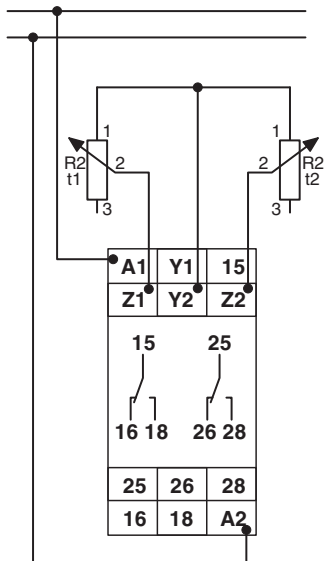

Connection to remote potentiometers for setting the time

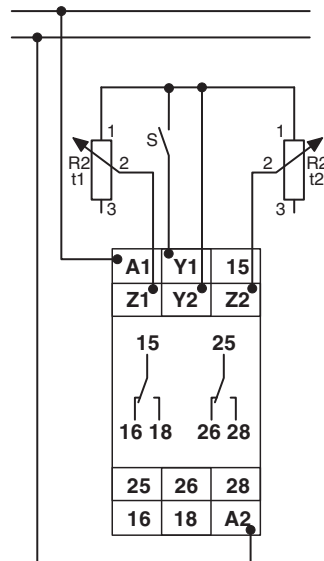

Connection to control contact and remote potentiometers

11 Function



ATTENTION: Module can become damaged

Only set the functions when the module is switched off.

If a remote potentiometer is connected, the internal potentiometer is deactivated.

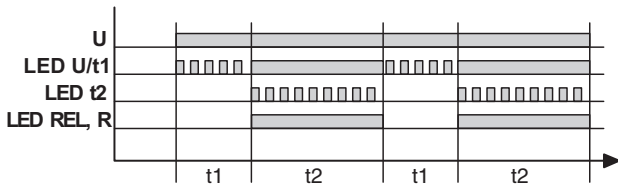

Ip: Switched-Mode Beginning With Pause

When supply voltage U is applied, set time t1 starts running (green "U/t1" LED flashes). Once time t1 has elapsed (green "U/t1" LED is ON), the output relay picks up (yellow "REL" LED is ON) and set time t2 starts running (green "t2" LED flashes).

Once time t2 has elapsed (green "t2" LED is OFF), the output relay drops out (yellow "REL" LED is OFF). The output relay is controlled in relation to set times t1 and t2 until the supply voltage is interrupted.

Time t1 = Pause time

Time t2 = Pulse time

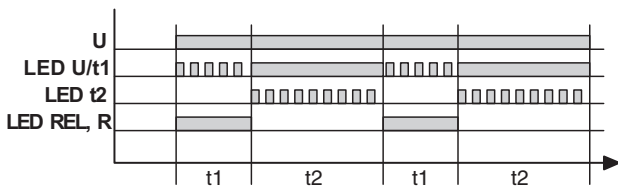

Ii: Switched-Mode Beginning With Pulse

When supply voltage U is applied, the output relay picks up (yellow "REL" LED is ON) and set time t1 starts running (green "U/t1" LED flashes). Once time t1 has elapsed (green "U/t1" LED is ON), the output relay drops out (yellow "REL" LED is OFF) and set time t2 starts running (green "t2" LED flashes).

Once time t2 has elapsed (green "t2" LED is OFF), the output relay picks up again (yellow "REL" LED is ON). The output relay is controlled in relation to set times t1 and t2 until the supply voltage is interrupted.

Time t1 = Pulse time

Time t2 = Pause time

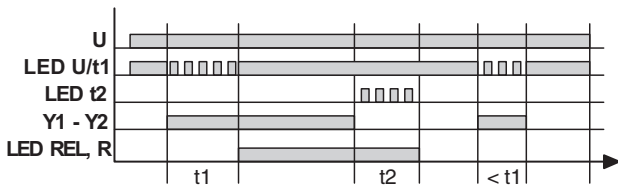

ER: With Switch-On and Release Delay With Control Contact

Supply voltage U must be applied permanently at the device (green "U/t1" LED is ON). When control contact Y1-Y2 is closed, set time t1 starts running (green "U/t1" LED flashes). Once time t1 has elapsed (green "U/t1" LED is ON), the output relay picks up (yellow "REL" LED is ON).

When the control contact is opened, set time t2 starts running (green "t2" LED flashes). Once time t2 has elapsed (green "t2" LED is OFF), the output relay drops out (yellow "REL" LED is OFF). If the control contact is opened before time t1 has elapsed, the elapsed time is deleted and restarted with the next cycle.

t1 = Switch-on delay

t2 = Release delay

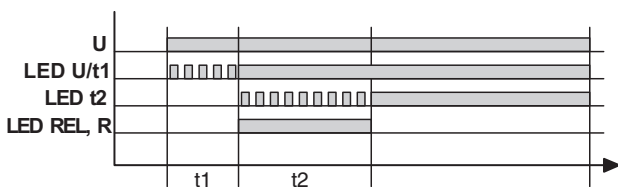

EWu: With switch-on delay and single shot leading edge, voltage controlled

When supply voltage U is applied, set time t1 starts running (green "U/t1" LED flashes). Once time t1 has elapsed (green "U/t1" LED is ON), the output relay picks up (yellow "REL" LED is ON) and set time t2 starts running (green "t2" LED flashes). Once time t2 has elapsed (green "t2" LED is OFF), the output relay drops out (yellow "REL" LED is OFF). If the supply voltage is interrupted before time t1+t2 has elapsed, the elapsed time is deleted and restarted the next time the supply voltage is applied again.

t1 = Switch-on delay
t2 = Operating time of the relay

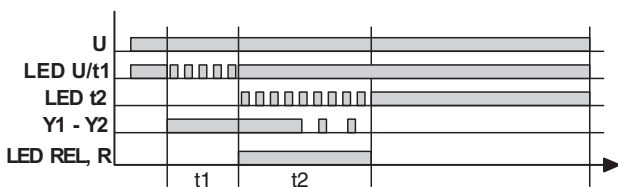

EWs: With switch-on delay and single shot leading edge with control contact

Supply voltage U must be applied permanently at the device (green "U/t1" LED is ON). When control contact Y1-Y2 is closed, set time t1 starts running (green "U/t1" LED flashes). Once time t1 has elapsed (green "U/t1" LED is ON), the output relay picks up (yellow "REL" LED is ON) and set time t2 starts running (green "t2" LED flashes). Once time t2 has elapsed (green "t2" LED is OFF), the output relay drops out (yellow "REL" LED is OFF). The control contact can be freely switched during this time. Another cycle cannot be started until the current cycle has been completed.

t1 = Switch-on delay
t2 = Operating time of the relay

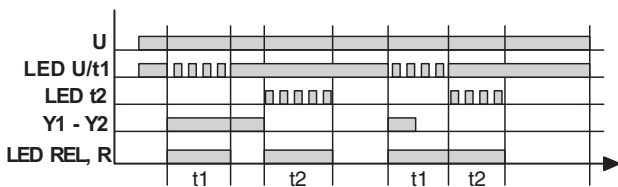

WsWa: With Single shot leading edge and single shot trailing edge with Control Contact

Supply voltage U must be applied permanently at the device (green "U/t1" LED is ON). When control contact Y1-Y2 is closed, the output relay picks up (yellow "REL" LED is ON) and set time t1 starts running (green "U/t1" LED flashes). Once time t1 has elapsed (green "U/t1" LED is ON), the output relay drops out (yellow "REL" LED is OFF). When the control contact is opened, the output relay picks up again (yellow "REL" LED is ON) and set time t2 starts running (green "t2" LED flashes). Once time t2 has elapsed (green "t2" LED is OFF), the output relay drops out (yellow "REL" LED is OFF). The control contact can be freely switched during this time.

t1 = Operating time of the relay after the control contact is closed
t2 = Operating time of the relay after the control contact is opened

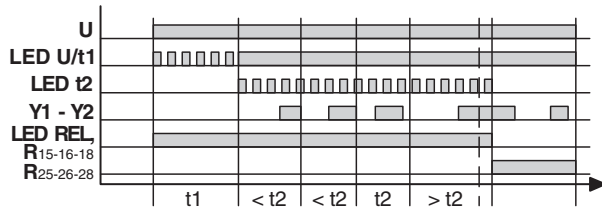

Wt: Pulse Sequence Evaluation

When supply voltage U is applied, set time t_1 starts running (green "U/t1" LED flashes) and output relay "R1" (15-16-18) picks up (yellow "REL" LED is ON). Once time t_1 has elapsed (green "U/t1" LED is ON), set time t_2 starts running (green "t2" LED flashes).

In order for output relay "R1" to remain picked up, the control contact must be closed and reopened within set time t_2 . Otherwise, output relay "R1" drops out (yellow "REL" LED is OFF) and output relay "R2" (25-26-28) picks up. All other pulses at the control contact are ignored. In order to restart the function, the supply voltage must be interrupted and applied again.

Компания «Life Electronics» занимается поставками электронных компонентов импортного и отечественного производства от производителей и со складов крупных дистрибьюторов Европы, Америки и Азии.

С конца 2013 года компания активно расширяет линейку поставок компонентов по направлению коаксиальный кабель, кварцевые генераторы и конденсаторы (керамические, пленочные, электролитические), за счёт заключения дистрибьюторских договоров

Мы предлагаем:

- Конкурентоспособные цены и скидки постоянным клиентам.
- Специальные условия для постоянных клиентов.
- Подбор аналогов.
- Поставку компонентов в любых объемах, удовлетворяющих вашим потребностям.
- Приемлемые сроки поставки, возможна ускоренная поставка.
- Доставку товара в любую точку России и стран СНГ.
- Комплексную поставку.
- Работу по проектам и поставку образцов.
- Формирование склада под заказчика.
- Сертификаты соответствия на поставляемую продукцию (по желанию клиента).
- Тестирование поставляемой продукции.
- Поставку компонентов, требующих военную и космическую приемку.
- Входной контроль качества.
- Наличие сертификата ISO.

В составе нашей компании организован Конструкторский отдел, призванный помогать разработчикам, и инженерам.

Конструкторский отдел помогает осуществить:

- Регистрацию проекта у производителя компонентов.
- Техническую поддержку проекта.
- Защиту от снятия компонента с производства.
- Оценку стоимости проекта по компонентам.
- Изготовление тестовой платы монтаж и пусконаладочные работы.



Тел: +7 (812) 336 43 04 (многоканальный)
Email: org@lifeelectronics.ru