

Cree® P4 LED CP41B-RDS/ADS CP41B-RFS/AFS CP41B-RHS/AHS



PRODUCT DESCRIPTION

This revolutionary package design allows the lighting designer to reduce the number of LEDs required and provide a more uniform and unique illuminated appearance than with other LED solutions.

This is possible through the efficient optical-package design and high-current capabilities. The low-profile package can be easily coupled with reflectors or lenses to efficiently distribute light and provide the desired lit appearance. This product family employs green and blue LED materials, which allows designers to match the color of many lighting applications such as vehicle signal lamps and amusement lighting.

FEATURES

- Size (mm): 7.6 x 7.6
- Color and Typical Dominant Wavelength:
Red (628nm)
Amber(591nm)
- Luminous Flux (mlm)

CP41B-RDS:(4400-11000)
CP41B-RFS:(4400-11000)
CP41B-RHS:(4400-13200)
CP41B-ADS:(4400-11000)
CP41B-AFS:(5500-13200)
CP41B-AHS:(5500-13200)
- Lead - Free
- RoHS Compliant

APPLICATIONS

- Channel Letter
- Amusement

ABSOLUTE MAXIMUM RATINGS ($T_A = 25^\circ\text{C}$)

Items	Symbol	Absolute Maximum Rating	Unit
		Red/Amber	
Forward Current	I_F	70 ^{Note1}	mA
Peak Forward Current ^{Note2}	I_{FP}	200	mA
Reverse Voltage	V_R	5	V
Power Dissipation	P_D	210	mW
Operation Temperature	T_{opr}	-40 ~ +100	$^\circ\text{C}$
Storage Temperature	T_{stg}	-40 ~ +100	$^\circ\text{C}$
Lead Soldering Temperature	T_{sol}	Max. 260 $^\circ\text{C}$ for 5 sec. max. (3 mm from the base of the epoxy bulb)	
Electrostatic Discharge Classification (MIL-STD-883E)	ESD	Class 2	

Note:

1. A heat sink is recommended if the device is operated at ambient temperatures higher than 25 $^\circ\text{C}$.
2. Pulse width ≤ 0.1 msec, duty $\leq 1/10$.

TYPICAL ELECTRICAL & OPTICAL CHARACTERISTICS ($T_A = 25^\circ\text{C}$)

Characteristics	Color	Symbol	Condition	Unit	Minimum	Typical	Maximum
Forward Voltage	Red/Amber	V_F	$I_F = 70$ mA	V		2.5	3.0
Reverse Current	Red/Amber	I_R	$V_R = 5$ V	μA			100
Dominant Wavelength	Red	λ_D	$I_F = 70$ mA	nm	620	628	637
	Amber	λ_D	$I_F = 70$ mA	nm	584	591	599
Luminous Flux	Red	CP41B-RDS (40 degree)	Φ_v	$I_F = 70$ mA	mIm	4400	7000
		CP41B-RFS (70 degree)	Φ_v	$I_F = 70$ mA	mIm	4400	7500
		CP41B-RHS (100 degree)	Φ_v	$I_F = 70$ mA	mIm	4400	8000
	Amber	CP41B-ADS (40 degree)	Φ_v	$I_F = 70$ mA	mIm	4400	6500
		CP41B-AFS (70 degree)	Φ_v	$I_F = 70$ mA	mIm	5500	7500
		CP41B-AHS (100 degree)	Φ_v	$I_F = 70$ mA	mIm	5500	8000
50% Power Angle	CP41B-RDS/ADS	$2\theta_{1/2}$	$I_F = 70$ mA	deg		40	
	CP41B-RFS/AFS	$2\theta_{1/2}$	$I_F = 70$ mA	deg		70	
	CP41B-RHS/AHS	$2\theta_{1/2}$	$I_F = 70$ mA	deg		100	

Note: Continuous reverse voltage can cause LED damage.

FLUX BIN LIMIT ($I_F = 70 \text{ mA}$)

Red

CP41B-RDS/RFS (40/70 degree)

Bin Code	Min.(mlm)	Max.(mlm)
LO	4400	5500
M0	5500	6600
N0	6600	8730
P0	8730	11000

CP41B-RHS (100 degree)

Bin Code	Min.(mlm)	Max.(mlm)
LO	4400	5500
M0	5500	6600
N0	6600	8730
P0	8730	11000
Q0	11000	13200

Amber

CP41B-ADS (40 degree)

Bin Code	Min.(mlm)	Max.(mlm)
LO	4400	5500
M0	5500	6600
N0	6600	8730
P0	8730	11000

CP41B-AFS/AHS (70/100 degree)

Bin Code	Min.(mlm)	Max.(mlm)
M0	5500	6600
N0	6600	8730
P0	8730	11000
Q0	11000	13200

- Tolerance of measurement of luminous flux is $\pm 15\%$

COLOR BIN LIMIT ($I_F = 70 \text{ mA}$)

Red

Bin Code	Min.(nm)	Max.(nm)
RE	620	637

Amber

Bin Code	Min.(nm)	Max.(nm)
A2	584	587
A3	587	590
A4	590	593
A5	593	596
A6	596	599

- Tolerance of measurement of dominant wavelength is $\pm 1 \text{ nm}$

VF BIN LIMIT ($I_F = 70 \text{ mA}$)

Red

Bin Code	Min.(V)	Max.(V)
23	2.0	2.2
24	2.2	2.4
25	2.4	2.6
26	2.6	2.8
27	2.8	3.0

Amber

Bin Code	Min.(V)	Max.(V)
23	2.0	2.2
24	2.2	2.4
25	2.4	2.6
26	2.6	2.8
27	2.8	3.0

- Tolerance of measurement of VF is $\pm 0.05\text{V}$.

ORDER CODE TABLE*

Color	Kit Number	Viewing Angle	Luminous Flux (mlm)		Dominant Wavelength			
			Min.	Max.	Color Bin	Min. (nm)	Color Bin	Max. (nm)
Red	CP41B-RDS-CL0P0EE4	40	4400	11000	RE	620	RE	637
Red	CP41B-RDS-CM0P0EE4	40	5500	11000	RE	620	RE	637

Color	Kit Number	Viewing Angle	Luminous Flux (mlm)		Dominant Wavelength			
			Min.	Max.	Color Bin	Min. (nm)	Color Bin	Max. (nm)
Red	CP41B-RFS-CL0P0EE4	70	4400	11000	RE	620	RE	637
Red	CP41B-RFS-CM0P0EE4	70	5500	11000	RE	620	RE	637
Red	CP41B-RFS-CN0P0EE4	70	6600	11000	RE	620	RE	637

Color	Kit Number	Viewing Angle	Luminous Flux (mlm)		Dominant Wavelength			
			Min.	Max.	Color Bin	Min. (nm)	Color Bin	Max. (nm)
Red	CP41B-RHS-CL0Q0EE4	100	4400	13200	RE	620	RE	637
Red	CP41B-RHS-CM0Q0EE4	100	5500	13200	RE	620	RE	637
Red	CP41B-RHS-CN0Q0EE4	100	6600	13200	RE	620	RE	637

ORDER CODE TABLE*

Color	Kit Number	Viewing Angle	Luminous Flux (mlm)		Dominant Wavelength			
			Min.	Max.	Color Bin	Min. (nm)	Color Bin	Max. (nm)
Amber	CP41B-ADS-CL0P0264	40	4400	11000	A2	584	A6	599
Amber	CP41B-ADS-CM0P0354	40	5500	11000	A3	587	A5	596
Amber	CP41B-ADS-CM0P0454	40	5500	11000	A4	590	A5	596

Color	Kit Number	Viewing Angle	Luminous Flux (mlm)		Dominant Wavelength			
			Min.	Max.	Color Bin	Min. (nm)	Color Bin	Max. (nm)
Amber	CP41B-AFS-CM0Q0264	70	5500	13200	A2	584	A6	599
Amber	CP41B-AFS-CN0Q0354	70	6600	13200	A3	587	A5	596
Amber	CP41B-AFS-CN0Q0454	70	6600	13200	A4	590	A5	596

Color	Kit Number	Viewing Angle	Luminous Flux (mlm)		Dominant Wavelength			
			Min.	Max.	Color Bin	Min. (nm)	Color Bin	Max. (nm)
Amber	CP41B-AHS-CM0Q0264	100	5500	13200	A2	584	A6	599
Amber	CP41B-AHS-CN0Q0354	100	6600	13200	A3	587	A5	596
Amber	CP41B-AHS-CN0Q0454	100	6600	13200	A4	590	A5	596

Notes:

- The above kit numbers represent order codes which include multiple flux-bin and color-bin codes. Only one flux-bin code and one color-bin code will be shipped on each reel. And single flux-bin code, single color bin-codes will not be orderable.
- Please refer to the "Cree LED Lamp Reliability Test Standards" document #1 for reliability test conditions.
- Please refer to the "Cree LED Lamp Soldering & Handling" document #2 for information about how to use this LED product safely.

#1: Refer to http://www.cree.com/led-components/media/documents/LED_Lamp_Reliability_Test_Standard.pdf

#2: Refer to <http://www.cree.com/led-components/media/documents/sh-HB.pdf>

GRAPHS

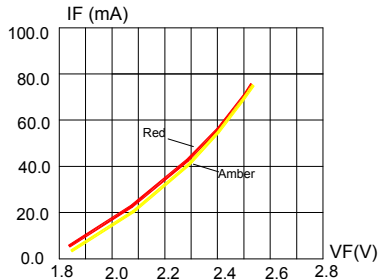

FIG.1 FORWARD CURRENT VS. FORWARD VOLTAGE.

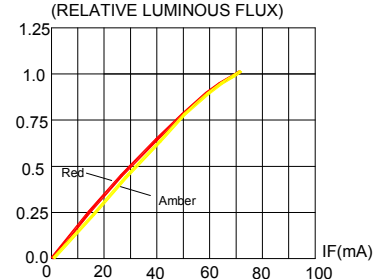

FIG.2 RELATIVE LUMINOUS FLUX VS. FORWARD CURRENT



FIG.3 Red & Amber REVERSE CURRENT VS. REVERSE VOLTAGE.

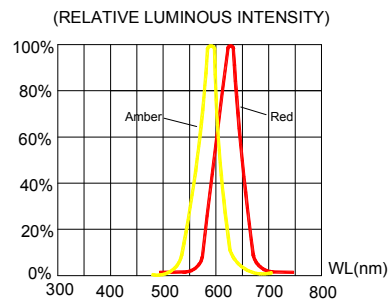

FIG.4 RELATIVE LUMINOUS INTENSITY VS. WAVELENGTH.

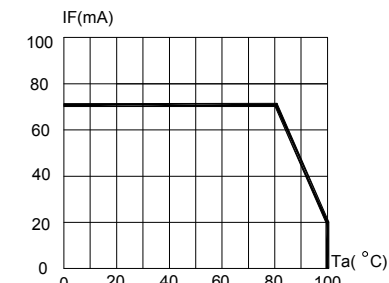

FIG.5 Red & Amber MAXIMUM FORWARD DC CURRENT VS AMBIENT TEMPERATURE ($T_{jmax}=120^{\circ}C$)

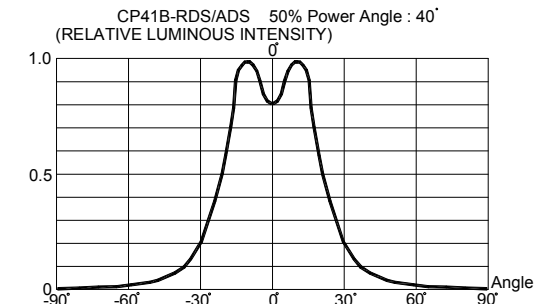

FIG.6 FAR FIELD PATTERN

The above data are collected from statistical figures that do not necessarily correspond to the actual parameters of each single LED. Hence, these data will be changed without further notice.

GRAPHS



FIG.7 FAR FIELD PATTERN



FIG.8 FAR FIELD PATTERN



FIG.9 FAR FIELD PATTERN

The above data are collected from statistical figures that do not necessarily correspond to the actual parameters of each single LED. Hence, these data will be changed without further notice.

MECHANICAL DIMENSIONS

All dimensions are in mm. Tolerance is ± 0.25 mm unless otherwise noted.

An epoxy meniscus extend about 1.5 mm down the leads.

All metal burr dimension is 0.2 mm max.

CP41B-RDS/ADS:



2,3: ANODE
 1,4: CATHODE

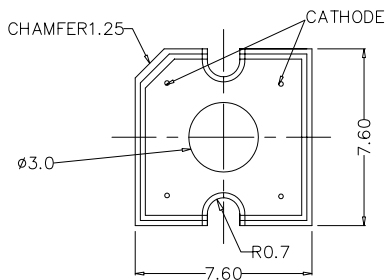

CP41B-RFS/AFS:



2,3: ANODE
 1,4: CATHODE



NOTES

RoHS Compliance

The levels of RoHS-restricted materials in this product are below the maximum concentration values (also referred to as the threshold limits) permitted for such substances, or are used in an exempted application in accordance with EU Directive 2011/65/EC (RoHS2), as implemented by EU member states on January 2, 2013 and amended on March 31, 2015 by EU Directive 2015/863/EU.

RoHS Declarations for this product can be obtained from your Cree representative or from the Product Ecology section of the Cree website.

Vision Advisory Claim

Users should be cautioned not to stare at the light of this LED product. The bright light can damage the eye.

MECHANICAL DIMENSIONS

All dimensions are in mm. Tolerance is ± 0.25 mm unless otherwise noted.

An epoxy meniscus extend about 1.5 mm down the leads.

All metal burr dimension is 0.2 mm max.

CP41B-RHS/AHS:



NOTES

RoHS Compliance

The levels of RoHS-restricted materials in this product are below the maximum concentration values (also referred to as the threshold limits) permitted for such substances, or are used in an exempted application in accordance with EU Directive 2011/65/EC (RoHS2), as implemented by EU member states on January 2, 2013 and amended on March 31, 2015 by EU Directive 2015/863/EU.

RoHS Declarations for this product can be obtained from your Cree representative or from the Product Ecology section of the Cree website.

Vision Advisory Claim

Users should be cautioned not to stare at the light of this LED product. The bright light can damage the eye.

KIT NUMBER SYSTEM

All dimensions in mm. Cree LED lamps are tested and sorted into performance bins. A bin is specified by ranges of color, forward voltage, and brightness. Sorted LEDs are packaged for shipping in various convenient options. Please refer to the "Cree LED Lamp Packaging Standard" document for more information about shipping and packaging options.

Cree LEDs are sold by order codes in combinations of bins called kits. Order codes are configured in the following manner:



REFLOW SOLDERING

The LED soldering specification is shown below (suitable for both leaded solder & lead-free solder):

Manual Soldering		Solder Dipping	
Soldering iron	35 W max	Preheat	110 °C max
Temperature	300 °C max	Preheat time	60 seconds max
		Solder-bath temperature	260 °C Max
Soldering time	3 seconds max	Dipping time	5 seconds max
Position	Not less than 3 mm from the base of the package.	Position	Not less than 3 mm from the base of the package.

- Manual soldering onto the PCB is not recommended because soldering time is uncontrollable.
- The recommended wave soldering is as below:



- Do not apply any stress to the LED package, particularly when heated.
- Only bottom preheat is suggested & should not preheat on top in order to reduce thermal stress experienced by the LEDs.
- The LEDs must not be re used once they have been extracted from PCB.
- After soldering the LEDs, the package should be protected from mechanical shock or vibration until the LEDs have reached 40 °C or below.
- Precautions must be taken as mechanical stress on the LEDs may be caused by PCB warpage or from the clinching and cutting of the LED leads.
- When it is necessary to clam the LEDs during soldering, it is important to ensure no mechanical stress is exerted on the LEDs.
- Cut the LED lead at normal room temperature. Lead cutting at high temperature may cause failure of the LEDs.

Refer to "<http://www.cree.com/led-components/media/documents/sh-HB.pdf>" for soldering & handling details.

PACKAGING

Features:

- The LEDs are packed in cardboard boxes after packaging in normal or anti-electrostatic bags.
- Cardboard boxes will be used to protect the LEDs from mechanical shock during transportation.
- The boxes are not water resistant, and they must be kept away from water and moisture.
- The Tube Pack type of packaging.
- Max 60 pcs per tube.

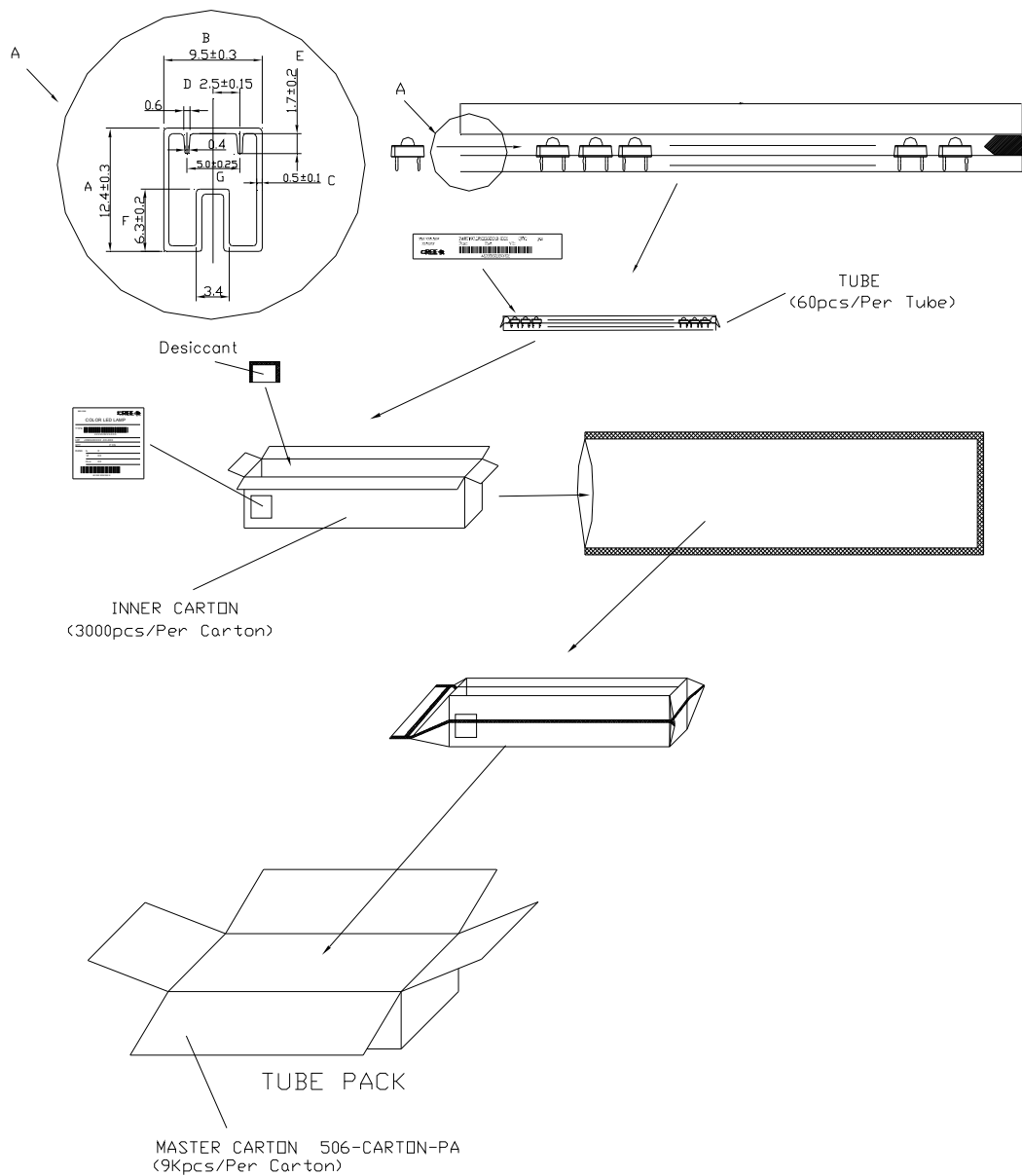

Компания «Life Electronics» занимается поставками электронных компонентов импортного и отечественного производства от производителей и со складов крупных дистрибьюторов Европы, Америки и Азии.

С конца 2013 года компания активно расширяет линейку поставок компонентов по направлению коаксиальный кабель, кварцевые генераторы и конденсаторы (керамические, пленочные, электролитические), за счёт заключения дистрибьюторских договоров

Мы предлагаем:

- Конкурентоспособные цены и скидки постоянным клиентам.
- Специальные условия для постоянных клиентов.
- Подбор аналогов.
- Поставку компонентов в любых объемах, удовлетворяющих вашим потребностям.
- Приемлемые сроки поставки, возможна ускоренная поставка.
- Доставку товара в любую точку России и стран СНГ.
- Комплексную поставку.
- Работу по проектам и поставку образцов.
- Формирование склада под заказчика.
- Сертификаты соответствия на поставляемую продукцию (по желанию клиента).
- Тестирование поставляемой продукции.
- Поставку компонентов, требующих военную и космическую приемку.
- Входной контроль качества.
- Наличие сертификата ISO.

В составе нашей компании организован Конструкторский отдел, призванный помогать разработчикам, и инженерам.

Конструкторский отдел помогает осуществить:

- Регистрацию проекта у производителя компонентов.
- Техническую поддержку проекта.
- Защиту от снятия компонента с производства.
- Оценку стоимости проекта по компонентам.
- Изготовление тестовой платы монтаж и пусконаладочные работы.



Тел: +7 (812) 336 43 04 (многоканальный)

Email: org@lifeelectronics.ru

www.lifeelectronics.ru