

Interactive Catalog Supplements Catalog PDFs

If you need detailed product information, or help choosing the right product for your application, see our [Interactive Catalog](#). Use the [Interactive Catalog](#) to access the most complete and up-to-date information available.

The [Interactive Catalog](#) provides an extensive collection of product specifications, application data, and technical literature that can be searched based on criteria you select.

This PDF catalog information was published in November 2000.



Sensing and Control
[Interactive Catalog...](#)

**Click this icon to try
the Interactive Catalog.**

Sensing and Control

Honeywell Inc.

11 West Spring Street

Freeport, IL 61032

Manual Switches

Miniature Manual Line



FEATURES

- Breadth of line offers complete selection of pushbuttons, rockers, and indicators to accommodate different functions and promote operator efficiency.
- Printed wiring board (PWB) or panel mounted switches, plus multi-unit strip mounting, and single level termination for cost-effective installation.
- Tactile feedback imparts a definite feel of switching action.
- Coordinated appearance enhances panel harmony.
- Illumination by long-life LEDs and incandescent lamps—for lighted display versatility.
- Solid state, electronic control and power duty switching—for electrical versatility.
- Temperature range: -18° to 65°C (0° to 149°F).

DESIGN FREEDOM

Rocker switches are available in the MICRO SWITCH MML Miniature Manual Line. They complement AML pushbuttons and indicators, providing you flexibility and design freedom to answer all your miniature manual control requirements. You can choose the actuator option that matches the switch function and natural habit pattern reflex of the operator. You no longer need to compromise quality, appearance, or human factors considerations, because of size constraints.

The MML pushbutton and indicator offering has also been expanded to include new square forms which are small enough to fit in the tightest places.

MOUNTING FLEXIBILITY

Printed wiring board (PWB) mounted switches can be arranged in individual panel openings or multi-unit strips, in a common panel cutout. Optional support brackets provide added rigidity for stand-alone PWB mounted devices. Units with bezels and mounting clips can be snap-in mounted from the panel front.

Single level PWB or solder/quick-connect termination throughout makes wiring faster, easier, and more economical. Housings are designed to accommodate washing, before and after wave soldering, to help prevent contamination during printed wiring board installation.

LIGHTED DISPLAY OPTIONS

Pushbuttons and indicators can be full-face illuminated by LEDs or incandescent lamps for high visibility of colors and legends. Inherently rugged, long-life LEDs reduce service and maintenance costs. Also, their low drive and inrush current (30 mA or less) reduces costs of drive circuitry.

Rockers can be furnished with colored lenses for illumination by LEDs or incandescent lamps.

CONTROL VERSATILITY

Solid state pushbutton switches with Hall effect integrated circuits interface directly with microprocessors and other logic level devices. Time-proven for billions of cycles, Hall effect ICs provide the ultimate in reliability.

Electronic control pushbutton or rocker switches, with gold or silver contacts, handle up to 1 amp; power duty switches, up to 6 amps.

Manual Switches

Miniature Manual Line

MML ENHANCES PANEL HARMONY

The attractive clean line design of the total MML offering is coordinated to work in harmony and enhance the visual qualities of your product. MML will help make a good first impression with your customers by blending with other panel components. And also work hard over the long run to maintain operator satisfaction.

HOW TO ORDER

To specify MML catalog listings, refer to the order guides. They are based on a modular cataloging system which gives you the flexibility to choose the combination of feature options that best answers the requirements of your application.

ORDER GUIDES

- Solid State Switches**
 - MML11 Pushbutton Switches 58
- Electronic Control Switches**
 - MML21 Pushbutton Switches 60
 - MML24 Rocker Switches 62
- Power Duty Switches**
 - MML31 Pushbutton Switches 64
- Indicators**
 - MML41 Indicators/LED or Incandescent Display 66
 - MML46 Indicators/LED or Incandescent Display 66
- Lenses and Buttons**
 - MML51 Lenses/Incandescent or Non-lighted Display 68
 - MML52 Lenses/LED or Neon Display 68
- Mounting Hardware**
 - MML61 Strip Mounting Frames 71
 - MML72/73 Bezels and Mounting Clips 72
 - MML74 PWB Mount Support Brackets 72
- LEDs, Lamps, Receptacles**
 - MML92/93 LED's/Receptacles 73/76
 - MML91/93 Incandescent Lamps/Receptacles 75/76



MML medical application. Intranavenous fluid flow controller automatically dispenses fluids for medications, therapy, and nutrition.



MML communications application. Mobile radio control keeps businesses in touch with employees on the road.

Manuals

Manual Switches

Miniature Manual Line

MML CHARACTERISTICS

	MML 10 Series	MML 20 Series	MML 30 Series	MML 40 Series
Mechanical Lifetime*				N/A
Pushbuttons–Momentary	1,000,000	250,000	100,000	---
Pushbuttons–Alternate	100,000	100,000	100,000	---
Rockers	100,000	250,000	100,000	---
Electrical Lifetime***				N/A
Pushbuttons–Momentary	1,000,000	25,000	25,000	---
Pushbuttons–Alternate	100,000	25,000	25,000	---
Rockers	100,000	25,000	25,000	---
Agency Ratings				
UL	File E53576	File E12252	File E12252	File E58932
CSA	File L R4442	File LR4442	File LR4442	File LR4442

*95% Survival

** Lifetime at Full Rated Load

MML ELECTRICAL DATA

MML10 SERIES

Electrical Characteristics	Integrated Circuit Function	5-24 VDC Sinking	
	Supply Current (Max.)	7 mA (Released) 8 mA (Operated no load)	
	Output Voltage (Operated)	0.3 Volt (Sinking 10 mA)	
	Output Leakage Current Max. (Released)	5.0 μ A	
	Switching Time Max.		
	Rise 10% to 90%	1.5 μ sec (Sinking 10 mA)	
	Fall 90% to 10%	0.5 μ sec (Sinking 10 mA)	
	Rated Output Current	10 mA Sinking	
	Absolute Maximum Ratings	Supply Voltage (V_s)	-28 to +28 VDC
		Voltage Externally Applied to Output	-0.5 Volt min. +28 Volts max. (Off condition)
Loads to Output		20 mA (Sinking)	
Storage Temperature		-40° to +85°C (-40° to +185°F)	
Operating Temperature		-18° to +65°C (0° to +149°F) and supply voltage of 4.5 to 5.5 VDC	

As with all solid state components, performance can be expected to deteriorate as rating limits are approached; however, they will not be damaged unless the limits are exceeded.

Manual Switches

Miniature Manual Line

MML20 SERIES

Electrical Rating (silver contacts)	Standard buttons Up to 1 amp, 125 VAC
	1 piece plunger/lens cap buttons: Black—Up to 1 amp, 125 VAC All others—Up to 0.5 amp, 125 VAC
Electrical Rating Gold Contacts	All button styles: Up to 0.25 amp, 30 VDC UL rating—0.10 amp, 30 VDC
	One pole Form C 

MML30 SERIES

MML31:

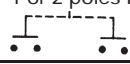
Electrical Rating Silver Contacts	6A @ 125 VAC, 250 VAC; 2A @ 30 VDC; 1A @ 125 VDC "L"; 1/10 hp @ 125 VAC
Contact Arrangement	1 or 2 poles Form X 

Manuals

Manual Switches

Solid State Pushbutton

MML11 Series

LED, INCANDESCENT, OR NON-LIGHTED DISPLAY



PWB Mount

FEATURES

- Hall effect reliability
- Provides low voltage signals that interface with nearly all DC logic
- Accepts one LED or incandescent lamp
- Printed wiring board mounting
- UL recognized, CSA certified
- Bezels and mounting clips, LEDs and legended lenses can be furnished installed or ordered separately

Example: MML11KK3AAKRSR

Furnished with black bezel; mounting clips (long sides); red LED, and red lens installed.

MML11 ORDER GUIDE

Catalog listing codes for switch, less assembled display options

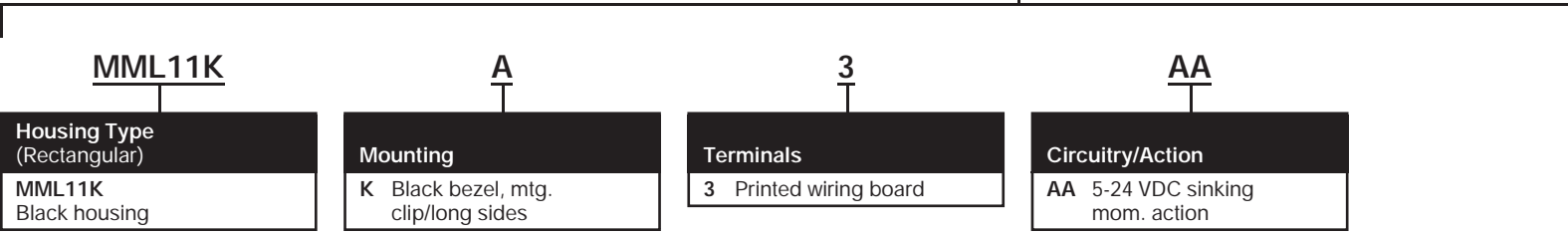

Manual Switches

Solid State Pushbutton Switches

Electrical Data	page 56
Strip and matrix mounting	page 71
Mounting dimensions	page 79
PWB pin locations	page 79
LED/receptacle	pages 73/74
Lamp/LED/Lens	pages 75/76

Current Sinking Output
 A permanent magnet plunger moves adjacent to the Hall effect integrated circuit to give a digital, current sinking (normally high and normally low) output.

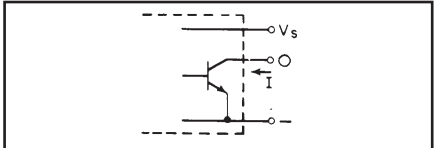

Order display options assembled to switch by adding codes below

K	RS	DR	Leave this space blank, []
Plunger	LED (Stanley Type)	Lens	Legend
K Black	XX No LED RS Red* YS Yellow* GS Green*	For LED display: DR Red DY Yellow DG Green For incandescent or non-lighted display: LR Red LY Yellow LG Green LW White LK Black	20 With Legend Use Legend Order Sheet FO-74024 to cover each catalog listing (see page 69).

* Permanently installed.

CUSTOMER INSTALLATION:

LED

- Order LED and receptacle, page 73.
- Installation instructions, page 74/76.

Incandescent Lamp

- Order lamp/PWB receptacle or lamp/solder receptacle, page 75.
- Installation instructions, page 76.

Manuals

Manual Switches

Electronic Control Pushbutton

MML21 Series

LED, INCANDESCENT, OR NON-LIGHTED DISPLAY

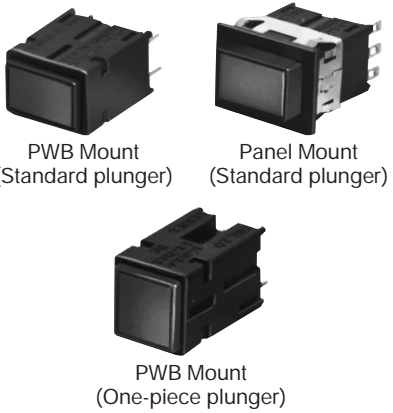

- FEATURES**
- Silver or gold contacts
 - Choice of rectangular or square housings
 - Accepts one LED or incandescent lamp
 - Printed wiring board or snap-in panel mounting
 - Bezels and mounting clips, LEDs and legended lenses can be furnished installed or ordered separately
 - UL recognized, CSA certified

Example: MML21KK3AAK
 Electronic control pushbutton switch with standard plunger; rectangular housing (black); bezel (black); mounting clips on long sides, PWB terminals; 1-pole, momentary action, silver contacts, black plunger.

Example: MML21KK3AAKRSDR
 As above, except furnished with red LED and red lens installed.

MML21KK3AAHRSXX20 as above, leg-ended.

Catalog listing codes for switch, less assembled display options

MML21 STANDARD PLUNGER SWITCHES ORDER GUIDE

MML21K		K		3		AA	
Housing Type		Mounting		Terminals		Circuitry/Action (Each pole is double throw)	
		Rectangular	Square			Rectangular	Square
MML21K Rectangular Black Housing MML21H Square Black Housing		A No bezel (PWB mounting) K Black bezel, mtg. clip/long sides	A No bezel (PWB mounting) R Black bezel & mtg. clip	3 Printed Wiring Board 2 Solder		Silver Contacts: AA 1 pole, mom. action AB 1 pole, alt. action AC 2 pole, mom. action AD 2 pole, alt. action Gold Contacts: BA 1 pole, mom. action BB 1 pole, alt. action BC 2 pole, mom. action BD 2 pole, alt. action	Silver contacts: AA 1-pole, mom. action AB 1-pole, alt. action Gold contacts BA 1-pole, mom. action BB 1-pole, alt. action

MML21 ONE PIECE LENS/PLUNGER SWITCHES ORDER GUIDE

Catalog listing codes for switch, less assembled display options

MML21H		K		3		AA	
Housing Type		Mounting		Terminals		Circuitry/Action (Each pole is double throw)	
		Rectangular	Square			Rectangular	Square
MML21K Rectangular Black Housing MML21H Square Black Housing		A No bezel (PWB mounting) K Black bezel, mtg. clip/long sides	A No bezel (PWB Mounting) R Black bezel & mtg. clip	3 Printed Wiring Board 2 Solder		Silver Contacts: AA 1 pole, mom. action AB 1 pole, alt. action AC 2 pole, mom. action AD 2 pole, alt. action Gold Contacts: BA 1 pole, mom. action BB 1 pole, alt. action BC 2 pole, mom. action BD 2 pole, alt. action	Silver contacts: AA 1-pole, mom. action AB 1-pole, alt. action Gold contacts BA 1-pole, mom. action BB 1-pole, alt. action

Manual Switches

Electronic Control Pushbutton Switches

Electrical Data	page 57
Bezels	page 72
Strip and matrix mounting	page 71
PWB pin locations	page 79

Order display options assembled to switch by adding codes below³

<p>K</p> <p>Plunger Type</p> <table border="1" style="width: 100%;"> <tr> <td>K</td> <td>Black</td> </tr> <tr> <td>W</td> <td>White</td> </tr> </table>	K	Black	W	White	<p>RS</p> <p>LED*</p> <table border="1" style="width: 100%;"> <tr> <td>XX</td> <td>No Led⁴</td> </tr> <tr> <td>RS</td> <td>Red⁵</td> </tr> <tr> <td>YS</td> <td>Yellow⁵</td> </tr> <tr> <td>GS</td> <td>Green⁵</td> </tr> </table>	XX	No Led ⁴	RS	Red ⁵	YS	Yellow ⁵	GS	Green ⁵	<p>DR</p> <p>Lens</p> <table border="1" style="width: 100%;"> <tr> <td>XX</td> <td>No Lens</td> </tr> <tr> <td colspan="2">For LED Display</td> </tr> <tr> <td>DR</td> <td>Red</td> </tr> <tr> <td>DY</td> <td>Yellow</td> </tr> <tr> <td>DG</td> <td>Green</td> </tr> <tr> <td colspan="2">For Incandescent or Unlighted Display</td> </tr> <tr> <td>LR</td> <td>Red</td> </tr> <tr> <td>LY</td> <td>Yellow</td> </tr> <tr> <td>LG</td> <td>Green</td> </tr> <tr> <td>LW</td> <td>White</td> </tr> <tr> <td>LK</td> <td>Black</td> </tr> </table>	XX	No Lens	For LED Display		DR	Red	DY	Yellow	DG	Green	For Incandescent or Unlighted Display		LR	Red	LY	Yellow	LG	Green	LW	White	LK	Black	<p>Legend</p> <table border="1" style="width: 100%;"> <tr> <td>20</td> <td>With Legend (Leave Blank if no legend needed)</td> </tr> </table> <p>Use Legend Order Sheet FO-74024 to cover each catalog listing. (See page 69.)</p>	20	With Legend (Leave Blank if no legend needed)
K	Black																																						
W	White																																						
XX	No Led ⁴																																						
RS	Red ⁵																																						
YS	Yellow ⁵																																						
GS	Green ⁵																																						
XX	No Lens																																						
For LED Display																																							
DR	Red																																						
DY	Yellow																																						
DG	Green																																						
For Incandescent or Unlighted Display																																							
LR	Red																																						
LY	Yellow																																						
LG	Green																																						
LW	White																																						
LK	Black																																						
20	With Legend (Leave Blank if no legend needed)																																						

CUSTOMER INSTALLATION:

LED

- Order LED and receptacle, page 73.
- Installation instructions, page 73/75.

Incandescent Lamp

- Order lamp/PWB receptacle or lamp/solder receptacle, page 74.
- Installation instructions, page 75.

Order display options assembled to switch by adding codes below

<p>H</p> <p>Button Color (One Piece Plunger)</p> <table border="1" style="width: 100%;"> <tr> <td colspan="2">For LED Display</td> <td colspan="2">For Incandescent or non-light display</td> </tr> <tr> <td>H</td> <td>Red</td> <td>R</td> <td>Red</td> </tr> <tr> <td>L</td> <td>Yellow</td> <td>Y</td> <td>Yellow</td> </tr> <tr> <td>N</td> <td>Green</td> <td>G</td> <td>Green</td> </tr> <tr> <td></td> <td></td> <td>Z</td> <td>Black</td> </tr> </table>	For LED Display		For Incandescent or non-light display		H	Red	R	Red	L	Yellow	Y	Yellow	N	Green	G	Green			Z	Black	<p>RS</p> <p>LED*</p> <table border="1" style="width: 100%;"> <tr> <td>XX</td> <td>No LED⁴</td> </tr> <tr> <td>RS</td> <td>Red⁵</td> </tr> <tr> <td>YS</td> <td>Yellow⁵</td> </tr> <tr> <td>GS</td> <td>Green⁵</td> </tr> </table>	XX	No LED ⁴	RS	Red ⁵	YS	Yellow ⁵	GS	Green ⁵	<p>Legend</p> <table border="1" style="width: 100%;"> <tr> <td>XX20</td> <td>With Legend (Leave Blank if no legend needed)</td> </tr> </table> <p>Use Legend Order Sheet FO-74024 to cover each catalog listing. (See page 69.)</p>	XX20	With Legend (Leave Blank if no legend needed)
For LED Display		For Incandescent or non-light display																														
H	Red	R	Red																													
L	Yellow	Y	Yellow																													
N	Green	G	Green																													
		Z	Black																													
XX	No LED ⁴																															
RS	Red ⁵																															
YS	Yellow ⁵																															
GS	Green ⁵																															
XX20	With Legend (Leave Blank if no legend needed)																															

- *Notes:**
- When an LED is specified in a **rectangular** MML21 listing, MICRO SWITCH will permanently install it in the housing.
 - MICRO SWITCH does **not** permanently install an LED in a **square** MML21 listing. To install an LED in a square housing, order a MML93L or MML93G receptacle and a MML92 LED (see pages 86 and 88).
 - Include four digits (XXXX or XX DR) when a legend is required.
 - For square or rectangular only.
 - For rectangular only.

Manuals

Manual Switches

Electronic Control Rocker Switches

MML24 Series

LED, INCANDESCENT, OR NON-LIGHTED DISPLAY



PWB Mount



Panel Mount



PWB Mount
(Lighted rocker)

FEATURES

- Accepts one or two LEDs or incandescent lamps which are ordered separately
- Printed wiring board mounting or snap-in panel mounting
- Bezels and mounting clips can be furnished installed or ordered separately
- UL recognized, CSA certified

MML24 ORDER GUIDE (Catalog listing for switch, less assembled display options)

MML24K	A	3	AA
Housing Type	Mounting	Terminals	Circuitry
MML24K Black housing	A No bezel (PWB mounting) K Black bezel, mtg. clip/long sides	3 Printed wiring board 2 Solder	Insert code letters from Circuitry Chart

Electrical Data	page 57
Bezels	page 72
Strip and matrix mounting	page 71
Mounting dimensions	pages 85/86
PWB pin locations	page 85

Rockers are permanently installed.

CIRCUITRY

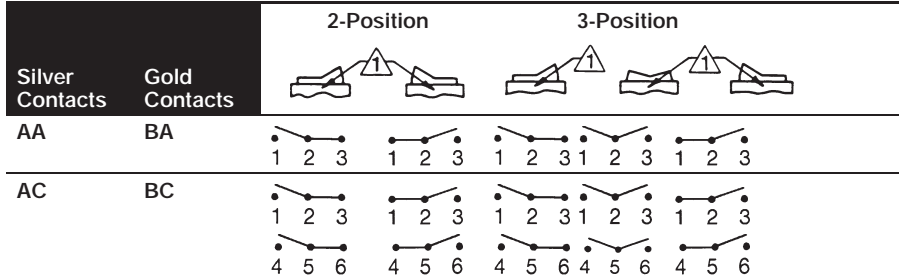

Example: MML24KA3AA01HDRXX
 Electronic control rocker switch with black housing, printed wiring board terminals; 1 pole, silver contacts; 2-position, maintained action; one circuit ON in each position; black rocker, red lens for LED display in Side 1 and no lens in Side 2.

The "MICRO SWITCH" identification is shown on this side of the switch housings.

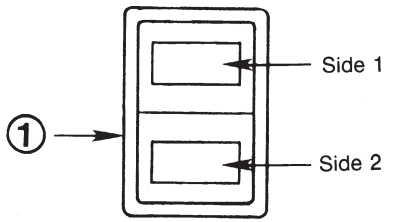

OPERATING ACTION

2-Position	01	Maint.	None	Maint.
	02	Mom.	None	Maint.
	03	Maint.	None	Mom.
3-Position	04	Maint.	Maint.	Maint.
	05	Mom.	Maint.	Mom.
	07	Mom.	Maint.	Maint.

Order display options assembled to switch by adding codes below.

01	H	DRXX	Leave blank, if legend not desired																												
Action Insert code numbers from Operating Action Chart	Rocker K Black rocker, non-lighted H Black rocker, one lens* F White rocker, one lens* <small>* Lighted switches with solder terminals require MML93R receptacle to install lamps or LEDs. See page 76.</small>	<table border="1"> <thead> <tr> <th colspan="2">Side 1</th> <th colspan="2">Side 2</th> </tr> </thead> <tbody> <tr> <td>XX</td> <td>None</td> <td>XX</td> <td>None</td> </tr> <tr> <td>LED display:</td> <td>Incand. display:</td> <td>LED display:</td> <td>Incand. display:</td> </tr> <tr> <td>DR Red</td> <td>LR Red</td> <td>DR Red</td> <td>LR Red</td> </tr> <tr> <td>DY Yellow</td> <td>LY Yellow</td> <td>DY Yellow</td> <td>LY Yellow</td> </tr> <tr> <td>DG Green</td> <td>LG Green</td> <td>DG Green</td> <td>LG Green</td> </tr> <tr> <td></td> <td>LW White</td> <td></td> <td>LW White</td> </tr> </tbody> </table>	Side 1		Side 2		XX	None	XX	None	LED display:	Incand. display:	LED display:	Incand. display:	DR Red	LR Red	DR Red	LR Red	DY Yellow	LY Yellow	DY Yellow	LY Yellow	DG Green	LG Green	DG Green	LG Green		LW White		LW White	Legend 20 With legend Use legend order sheet FO-74193 to cover each catalog listing (see page 70).
Side 1		Side 2																													
XX	None	XX	None																												
LED display:	Incand. display:	LED display:	Incand. display:																												
DR Red	LR Red	DR Red	LR Red																												
DY Yellow	LY Yellow	DY Yellow	LY Yellow																												
DG Green	LG Green	DG Green	LG Green																												
	LW White		LW White																												

CUSTOMER INSTALLATION:

LED

- Order LED and receptacle, page 73.
- Installation instructions, pages 74/76.

Incandescent Lamp

- Order lamp/PWB receptacle or lamp/solder receptacle, page 75.
- Installation instructions, page 76.

Manuals

Manual Switches

Power Duty Pushbutton

NON-LIGHTED DISPLAY



PWB Mount



Panel Mount

FEATURES

- Printed circuit board or snap-in panel mounting
- Bezels and mounting clips, and legended lenses can be furnished installed or ordered separately
- UL recognized, CSA certified.

Example: MML31KK2AAK

Power duty pushbutton switch housing (black); bezel (black) and mounting clips; solder terminals; 1 pole, momentary action; black plunger.

Example: MML31KK2AAKLR

As above, except furnished with red lens.

MML31 ORDER GUIDE

Catalog listing codes for switch, less assembled display options

MML31K

Housing Type (Rectangular)

MML31K
Black housing, non-lighted

K

Mounting

A No bezel (PWB mounting)
K Black bezel, mtg. clip/long sides

2

Terminals

3 Printed wiring board
2 Solder/Quick-connect

AA

Circuitry/Action

(Each pole is single-throw, normally open)

AA 1 pole, mom. action
AB 1 pole, alt. action
AC 2 poles, mom. action
AD 2 poles, alt. action

Electrical Data	page 57
Bezels	page 72
Strip and matrix mounting	page 71
Mounting dimensions	pages 85/86
PWB pin locations	page 85

Order display options assembled to switch by adding codes below

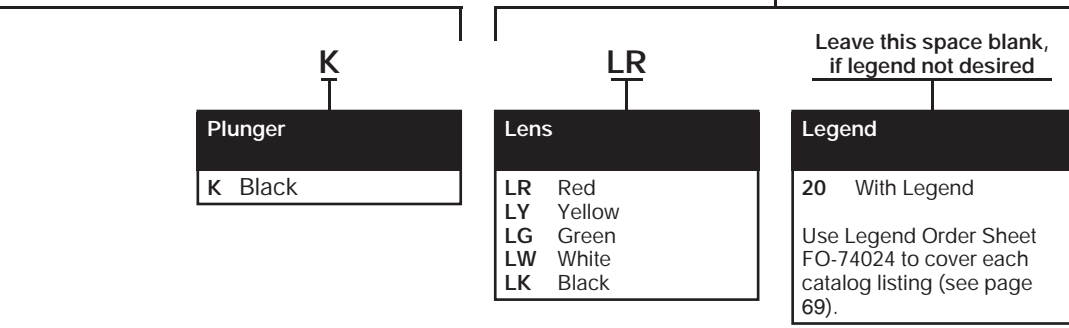

Manuals

Manual Switches

Indicators/Pushbutton Style

MML41/46 Series

LED OR INCANDESCENT DISPLAY



PWB Mount



Panel Mount

FEATURES

- Accepts one LED or incandescent lamp

MML41 indicators resemble a pushbutton switch with the button in the "down" position.

MML41 ORDER GUIDE

Catalog listing codes for indicator, less assembled display options

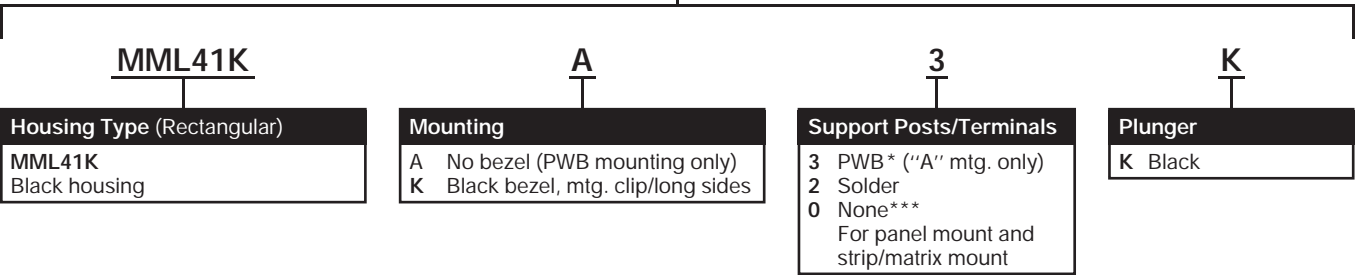

Indicators/Flush Mount MML46

LED OR INCANDESCENT DISPLAY



PWB Mount



Panel Mount



PWB Mount



Panel Mount

FEATURES

- Accepts one or two LEDs or incandescent lamps
- Bezels and mounting clips, LEDs and legended lenses can be furnished installed or ordered separately

MML46 ORDER GUIDE

Catalog listing codes for indicator, less assembled display options

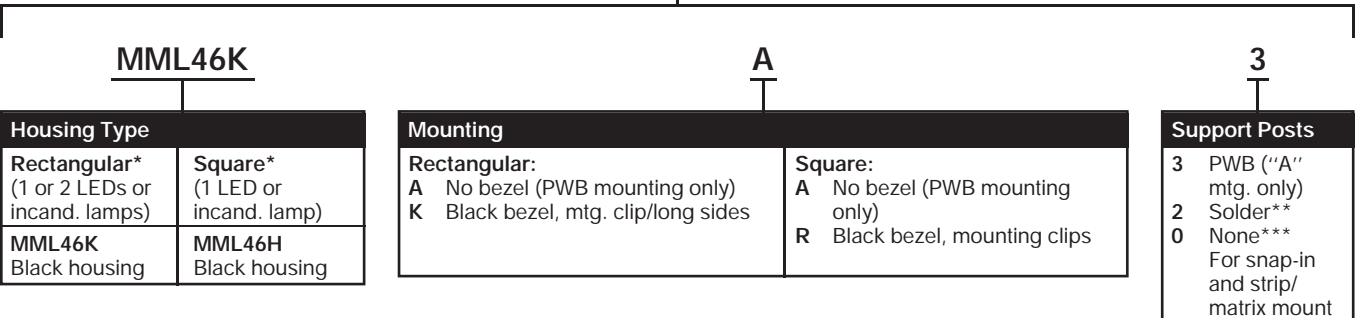

** Rectangular housings only.
*** No LEDs allowed.

* Notes:

1. When an LED is specified in a rectangular MML46 listing, MICRO SWITCH will permanently install it in the housing.
2. MICRO SWITCH does **not** permanently install an LED in a square MML46 listing. To install an LED in a square housing, order a MML93L or MML93G receptacle and a MML92 LED (see pages 74 and 76).

Manual Switches

Indicators/Pushbutton Style

Example: MML41KA3K
 Pushbutton style indicator housing (black); no bezel; support posts; black plunger.

Example: MML41KA3KRSDR
 As above, except furnished with one red LED and red lens.

Electrical Data	page 57
Lenses	page 68
Bezels	page 72
LEDs/Lamps	pages 73/75
Strip and matrix mounting	page 71
Mounting dimensions	pages 80/82/83
PWB pin locations	pages 80/84

Order display options assembled to indicator by adding codes below

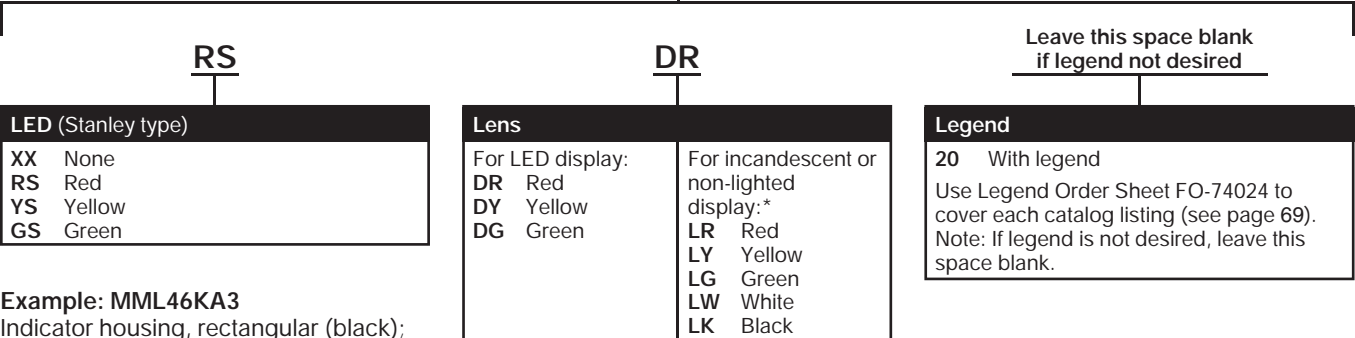

Example: MML46KA3
 Indicator housing, rectangular (black); no bezel; support terminals.

Example: MML46KA3RSXXDR20
 As above, except furnished with red LED and red lens, with legend.

* When ordering incandescent or non lighted display, LED field must be XX.

CUSTOMER INSTALLATION:

LED

- Order LED and receptacle, page 73.
- Installation instructions, pages 74/76.

Incandescent Lamp

- Order lamp/PWB receptacle or lamp/solder receptacle, page 75.
- Installation instructions, page 76.

LED TERMINATION

If LEDs are to be permanently installed by MICRO SWITCH, please indicate by either a **2** (solder) or a **3** (PWB) for the Support Posts listing code. With MICRO SWITCH identification to the rear, the longest lead (+) anode will be to the left, closest to the double-pole circuit or support terminals.



Style 2



Style 3

Manuals

Order display options assembled to indicator by adding codes below

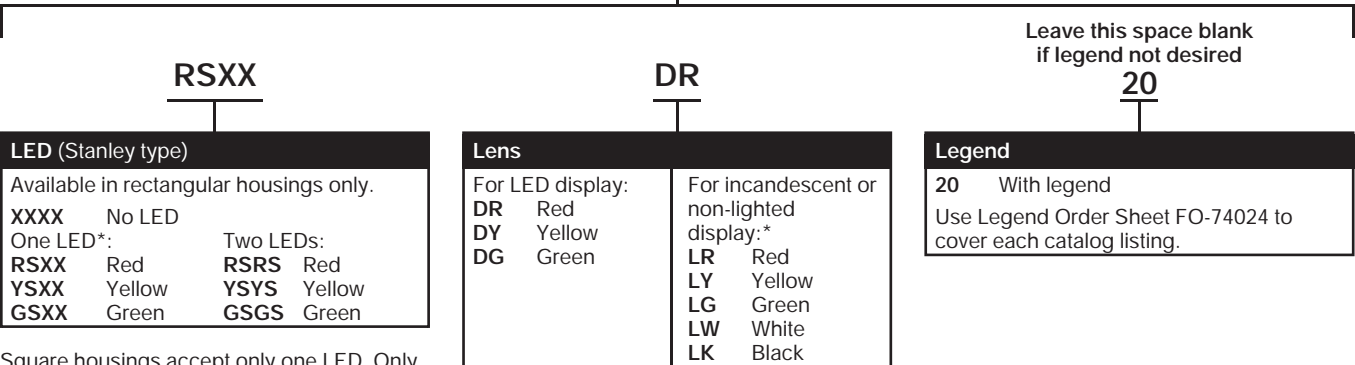

Square housings accept only one LED. Only a two-character LED code is necessary.
 Example: MML46HR0XXDY.

* When ordering incandescent or non-lighted display, LED field must be XXXX.

Manual Switches

Button Lenses/Incandescent or Non-lighted Display

MML51 ORDER GUIDE

For standard plunger MML pushbuttons.

MML51E

Lens Type
Rectangular Lenses:
MML51E Switch lens*
MML51G Indicator lens
Square Lenses:
MML51C Switch lens
MML51D** Indicator lens

20

Display/Legend Type
Transmitted Color:
10 No legend
20 With legend

R

Color
R Red
Y Yellow
G Green
W White
K Black (Opaque)

Example: MML51E20R

Incandescent or non-lighted display switch lens; red transmitted color, with legend.

LEGENDING

Use the MML Legend Order Sheets on pages 81 and 82 to specify legending.

* Use MML51E with MML41 rectangular pushbutton style indicators.

** MML51D for use with MML41 square.

Button Lenses/LED

MML52

MML52 ORDER GUIDE

For standard plunger MML pushbuttons.

MML52G

Lens Type
Rectangular Lenses:
MML52E Switch lens, LED display
MML52G* Indicator lens LED display
Square Lenses:
MML52C Switch lens, LED display
MML52D** Indicator lens, LED display

10

Display/Legend Type
Transmitted Color:
10 No legend
20 With legend

Y

Color/ Illumination
LED Display:
R Red
Y Yellow
G Green
C Clear

Square lenses have tabs on two sides. Before snapping in place, the tabs should be at right angles to the housing side with the MICRO SWITCH logo. (See below.)

MICRO SWITCH logo on housing

Lens key tab

Example: MML52G10Y

LED display indicator lens; yellow transmitted color, no legend.

* Use MML52E with MML41 rectangular pushbutton style indicators.

** Use MML52D with MML41 square.

HOW TO INSTALL LENSES

Keytabs on two sides of the lenses mate with matching button slots.

Rectangular lenses have tabs on the long sides. Seat a long side before snapping in place.

HOW TO INSTALL LENSES

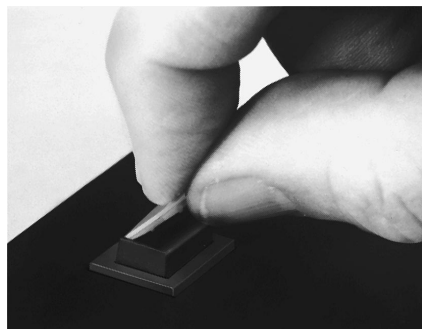

1. Seat lens.

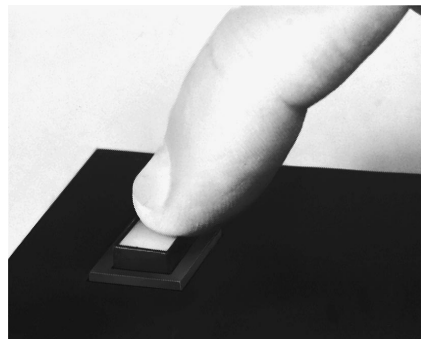

2. Snap in place.

Honeywell

MML Pushbutton/Indicator Lens

Legend Order Guide/Product Specification (PG ____ of ____)

Catalog Listing MML 5 _____	
Customer P.O. No.	Customer Dwg. No.
MICRO SWITCH Sales Order	Line Number
	Schedule No.

Customer: _____
 Address: _____

 _____ (state)

Instructions

1. Fill in appropriate catalog listing - one listing/sheet.
2. Check proper figure #, Type size, Type color.
3. Fill in quantity required.
4. Indicate legends desired — Do not exceed maximums shown in Legend Order Guide.

Switch & Indicator Lense Type Orientation	Figure No	Max Lines/Area		Max Characters/Line					
		5/64	7/64	9/64	13/64	5/64	7/64	9/64	13/64
	1	2	1	1	1	3	2	2	1
	2	2	1	1	1	4	3	2	2
	3	1	1	1	1	6	4	3	2
	4	2	1	1	1	7	4	4	3

Note

1. For Proper Legend Orientation, MML housings (when viewed from front of panel) should have "MICRO SWITCH" logo oriented "Up"
2. All legends will be centered within Legend Area.
3. Please use black ink in filling out this form to help us process your order.

LEGEND ORDER CHART

Customer Part No	Fig No	Type Size 7/64	Ink Color		Button Qty	Legend Description			
			5/64	9/64		13/64	1st Line	2nd Line	

FO-74024-B





 (Signature) _____ (Date)

Hot Stamp Legending

Modified Gothic lettering (A thru Z), numerals (0 thru 9) and Symbols below available in 5/64, 7/64, 9/64, and 13/64.		A3 Modified Gothic									
STANDARD SYMBOLS AVAILABLE											
·	;	!	?	'	-	"	/	()	*	&
\$	¢	#	%	o	+	-	±	÷	x	=	≠
→	↑	↓	↔	←	↘	↙	↗	↖	↕	∞	<
SPECIAL LEGENDS											
NOTE: Use this area to show special Legend Locations or Configurations NOT shown above. NON-STANDARD legends will involve additional charges and increased delivery time.											
Fig. "A"						Fig. "B"					

Manuals

MML ROCKER LEGEND ORDER GUIDE/PRODUCT SPECIFICATION (PG. of)
Catalog Listing **MML**

Switch Type & Orientation	Figure No	Max Lines/Area			Max Characters/Line				
		5/64	7/64	9/64	13/64	5/64	7/64	9/64	13/64
MML 24, 34 4 x .6 Size 	1	2	1	1	1	3	2	2	1
MML 24, 34 .4 x .6 Size Umbrella and MML 34 .6 x .8 Size 	2	1	1	1	1	3	3	2	1
MML 24, 34 .4 x .6 Size Umbrella and MML 34 .6 x .8 Size 	3	3	2	2	1	4	3	3	2
MML 24, 34 .4 x .6 Size Umbrella and MML 34 .6 x .8 Size 	4	2	1	1	1	6	4	4	2

Note

- For Proper Legend Orientation, MML housings (when viewed from front of panel) should have "MICRO SWITCH" logo oriented to the left. For other Orientation, indicate the Housing Logo Location in Special Legend Area.
- All legends will be centered within Legend Area.
- Please use black ink in filling out this form to help us process your order.

LEGEND ORDER CHART

Customer Part No	Fig No	Side No	Type Size			Ink Color		Button Qty	Legend Description	
			5/64	7/64	9/64	13/64	Black		White	1st Line

FO-74193-B

(Signature)

Customer P.O. No. _____
Customer Dwg. No. _____

MICRO SWITCH Sales Order _____
Line Number _____
Schedule No. _____

Customer: _____

Address: _____

(city) _____ (state) _____

Instructions

- Fill in appropriate catalog listing - one listing/sheet.
- Check proper figure #, Type size, Type color.
- Fill in quantity required.
- Indicate legends desired — Do not exceed maximums shown in Legend Order Guide.

Modified Gothic lettering (A thru Z), numerals (0 thru 9) and Symbols below available in 5/64, 7/64, 9/64, and 13/64.	A3 Modified Gothic
STANDARD SYMBOLS AVAILABLE	
. ; ! ? ' - " / () * &	
\$ ¢ # % 0 + - ± ÷ × = ≠ > <	
→ ↕ ← ↖ ↗ ↘ ↙ ↚ ↛	
← Cr 1/4 1/2 3/4 1/3 2/3 ∞	

SPECIAL LEGENDS

NOTE: Use this area to show special Legend Locations or Configurations NOT shown above. NON-STANDARD legends will involve additional charges and increased delivery time.

Fig. "A" _____ Fig. "B" _____

Manual Switches

Strip Mounting Frames

MML61 Series

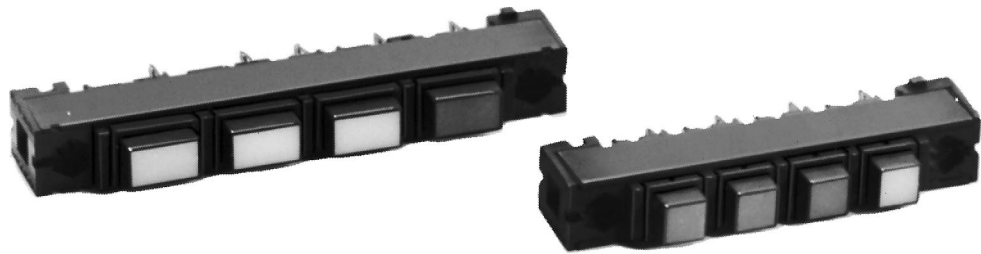

MML61 ORDER GUIDE

MML61K

5

Orientation/Color
For Rectangular* Housings:
MML61K Horizontal strip, black
MML61G Vertical strip, black
For Square Housings
MML61J Black

No. of Stations
1 One
2 Two
3 Three
4 Four
5 Five
6 Six
7 Seven
8 Eight
9 Nine
10 Ten

Note: Switches and indicators are ordered as separate items.

FEATURES

- Provides back of panel or printed wiring board mounting in a multi-unit strip of switches/indicators.
- Devices can be pre-wired prior to installation.
- Holes at each end of frame will accept No. 4 screws.
- Can be used for pushbutton or rocker type switches.

Example: MML61K5

Black 5-station strip mounting frame, horizontal orientation.

Manuals

Manual Switches

Bezels/Mounting Clips

MML72 Series

MML72EEK
(Black switch bezel, mounting clips on long sides)

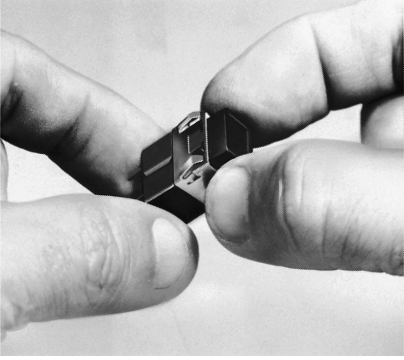

1. Slip mounting clip over top of switch/indicator housing.

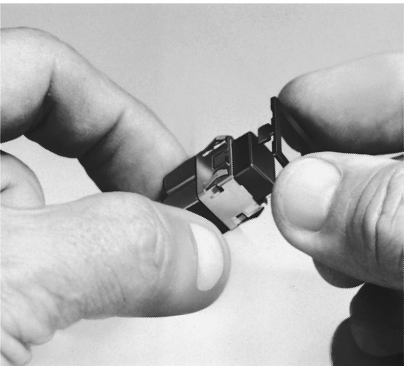

2. Snap bezel onto mounting clip.

Recommended panel thickness for panel mounted units is .050 to .094 in. (1,27 to 2,39 mm).

TO ORDER MOUNTING CLIPS SEPARATELY

For Rectangular Housings: MML73EA (long sides) MML73EB (short sides)
--

LED APPLICATION INFORMATION

To insure stable conditions, suitable external control of the LED current must be provided. It is recommended that a minimum of 5 VDC open circuit voltage with an appropriate series resistance be used to drive LED devices. This minimizes current variation and its effect on temperature and forward voltage of the LED.

Resistor values can be determined by supply voltage or current for LED:

$$R_s = \frac{E - V_f}{I_f}$$

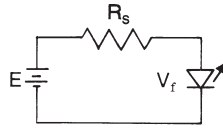

WHERE: R_s = Series Resistance
 E = Supply Voltage
 V_f = Forward Voltage of LED
 I_f = Circuit Current

Maximum drive current is 30 mA. Reverse voltage breakdown of the LED's is 4 volts (min.).

MML92 ORDER GUIDE

LEDs should be the same color as the lenses they illuminate. They are packed 10 per listing, including stand-off spacers for use when solder terminating to a printed wiring board, per procedure 3 on page 74.

LED Type	Use To Illuminate	Catalog Listing	LED Color	Forward Characteristics Typ. @ 20mA	Max.	LED Manufacturers' Part Numbers
T-1 $\frac{3}{4}$	Rectangular button lens	MML92ERS MML92EGS MML92EYS	Red Green Yellow	1.7 V 2.1 V 2.1 V	Stanley: 2.0 V 2.5 V 2.5 V	ESBR5633 ESBG5633 ESAY5633
		MML92ERH MML92EGH MML92EYH	Red Green Yellow	2.2 V 2.3 V 2.2 V	Hewlett Packard: 3.0 V 3.0 V 3.0 V	HLMP-3366 HLMP-3568 HLMP-3466
T-1	Square button lens, MML24 rocker lens rectangular button lens	MML92HRS MML92HGS MML92HYS	Red Green Yellow	1.7 V 2.1 V 2.2 V	Stanley: 2.0 V 2.5 V 2.5 V	ESBR3901 ESPY3901 ESAY3901
		MML92HRH MML92HGH MML92HYH	Red Green Yellow	2.2 V* 2.3 V* 2.2 V	Hewlett Packard: 3.0 V 3.0 V 3.0 V	HLMP-1340 HLMP-1540 HLMP-1440

Long lead: Anode (+). Short lead: Cathode (-).
 * @ 25 mA.

Manuals

MML93 LED PWB RECEPTACLE ORDER GUIDE

LED Type	Use to Illuminate	Catalog Listing
T-1 $\frac{3}{4}$	Rectangular button lens or umbrella button lens	MML93K
T-1	Square button lens or MML24 rocker lens	MML93G

MML93 LED SOLDER TERMINAL ORDER GUIDE

LED Type	Use to Illuminate	Catalog Listing
T-1	Square button (base only)	MML93L
T-1	MML24 rocker lens (base only)	MML93R
T-1	Rectangular button (base and terminal)	MML93J

Factory installed. Certain MML switches and indicators can be furnished with LEDs permanently factory installed, where specified in the order guides.

User installed. LEDs can also be ordered separately and installed in these products by the user, per the procedures described below.

LED INSTALLATION

1. With Printed Wiring Board Receptacle. (MML93K)

PWB receptacle enables T-1 3/4 or T-1 LEDs to be added or replaced behind the printed wiring board, without soldering. LEDs and receptacles are ordered separately. See page 75.

Printed wiring boards are not supplied.

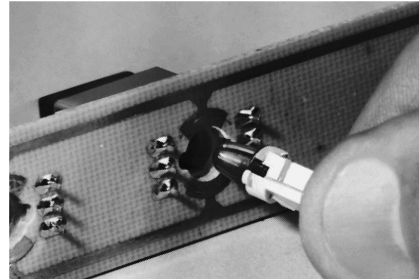

1. Insert the LED/PWB receptacle assembly through a hole in the printed wiring board.

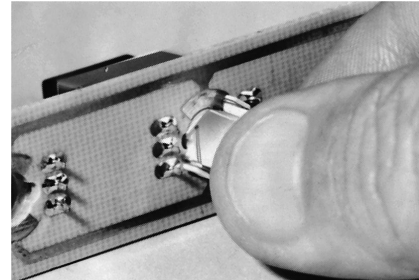

2. A 1/8-turn applied clockwise to the receptacle locks it in the printed wiring board and establishes the electrical connection.

2. With Solder Terminal Receptacle. (MML93J)

This receptacle attaches directly to the rear of panel-mounted units. It enables incandescent lamps to be added or replaced without rewiring. LEDs and receptacles are ordered separately.

This receptacle is for use with all rectangular pushbuttons and MML41 or MML46 rectangular indicators only.

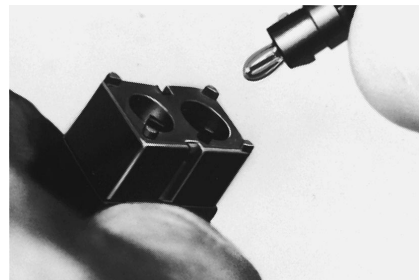

1. Insert solder terminal receptacle into hole in base of panel mount unit.

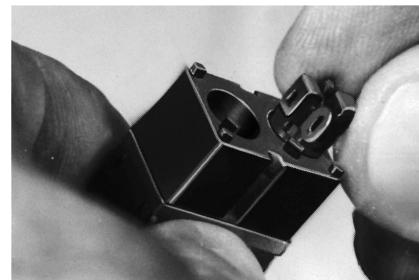

2. A 1/8-turn clockwise applied to the receptacle locks it in the base.

3. By Soldering To Printed Wiring Board.

In this procedure, the housing is mounted on the printed wiring board after the T-1 3/4 LED has been seated.

This procedure can be used with any MML having PWB terminals.

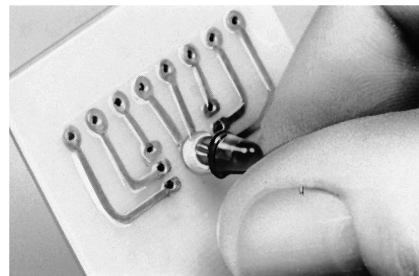

1. Assemble stand-off spacer to LED terminals and seat on printed wiring board.

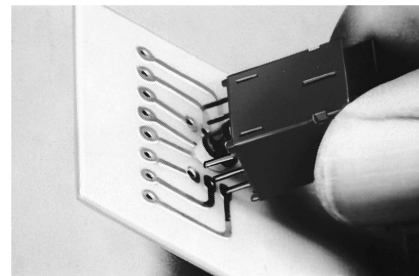

2. Seat housing on printed wiring board, with LED projecting into hole at the base of the housing.

4. By Soldering to Printed Wiring Board or Leadwire (MML44 indicators only).

T-1 3/4 LEDs are added to MML44 indicators via a procedure which is unique to this product. The LED is inserted from the top of the housing with the leadwires protruding through the housing base.

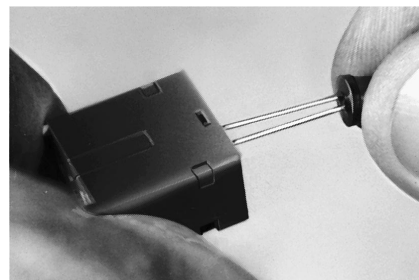

1. Assemble LED to MML44 indicator, with the LED terminals protruding through assembly slot in the middle of housing base.

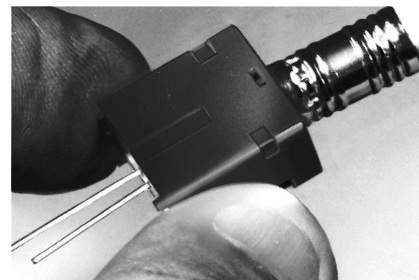

2. Use pencil eraser to snap LED securely in place.

Manual Switches

Incandescent Lamp Assemblies

MML91 LAMP/PWB RECEPTACLE ORDER GUIDE

Lamp Type	Use To Illuminate	Voltage	Catalog Listing Incl. Lamp & PWB Receptacle	Industry Lamp No.
T-1 ① (unbased)	Rectangular button lens	5 28	MML91C MML91DC	715 6838
T-1 ② (bi-pin)	Square button lens and MML24 rocker lens	5 28	MML91E MML91DE	7715 7839

Notes:

① To order PWB receptacle separately, specify **MML93H**.

② To order PWB receptacle separately, specify **MML93G**.

MML91 LAMP/SOLDER RECEPTACLE ORDER GUIDE

Lamp Type	Use To Illuminate	Voltage	Catalog Listing Incl. Lamp & Solder Receptacle	Industry Lamp No.
T-1 ③ (bi-pin)	Rectangular button lens	5 28	MML91D MML91DD	7715 7839

Lamp Type	Use To Illuminate	Voltage	Catalog Listing ④		Industry Lamp No.
			Solder Receptacle	T-1 (Unbased) Lamp Only	
T-1 (unbased)	Square button lens	5 28	MML93L MML93L	MML91A MML91DA	715 6838
T-1 (unbased)	MML24 rocker lens	5 28	MML93R MML93R	MML91A MML91DA	715 6838

Notes:

③ To order solder receptacles separately, specify **MML93J**.

④ Order solder receptacles and T-1 lamp listings for complete assembly.



LED/Incandescent Lamp Receptacles

User installed. Certain MML switches and indicators will accept incandescent lamps, where specified in the order guides.

These lamps are ordered separately and installed by the user, per the procedures described below.

LAMP INSTALLATION

1. With Printed Wiring Board Receptacle for MML93G and MML93H only.

Use PWB receptacles to permit lamps to be added or replaced from behind the printed wiring board, without soldering.

These receptacles are for use with rectangular pushbuttons, square pushbuttons and MML24 rocker lens only.

Printed wiring boards are not supplied.

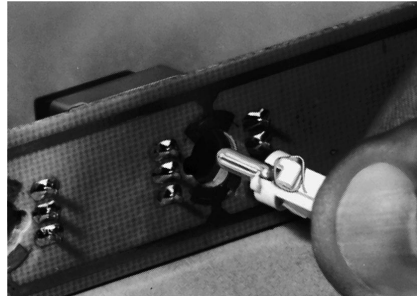

1. Insert the PWB receptacle/incandescent lamp assembly through a hole in the printed wiring board.

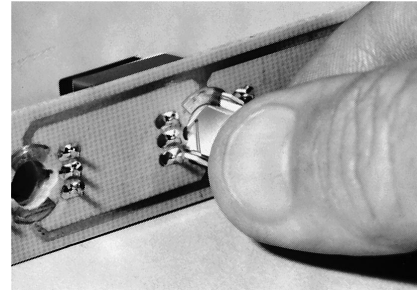

2. A 1/8-turn applied clockwise to the receptacle locks it in the printed wiring board and establishes the electrical connection.

2. With Solder Terminal Receptacle for MML93J bi-pin only

This receptacle attaches directly to the rear of panel-mounted units. It enables lamps to be added or replaced without rewiring.

This receptacle is for use with all rectangular pushbuttons and MML41 or MML46 rectangular indicators only.

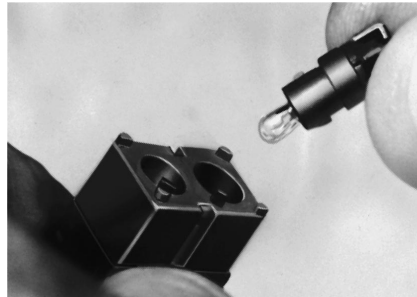

1. Insert solder terminal receptacle into hole in base of panel mount unit.

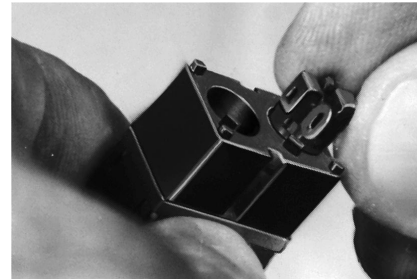

2. A 1/8-turn clockwise applied to the receptacle locks it in the base.

3. With Solder Terminal Receptacles for MML93L/93R Unbased Only or T-1 LED.

Use the receptacles shown at right to install T-1 LEDs or T-1 unbased lamps in panel-mounted MML21 square pushbutton switches and MML24 rocker switches.

Procedure:

1. Assemble LEDs or lamps to receptacles (leads first).
2. Snap receptacle into slots in housing base.
3. Solder directly to leads.

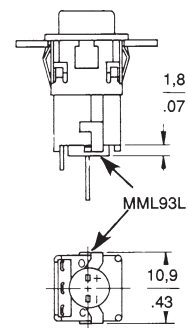
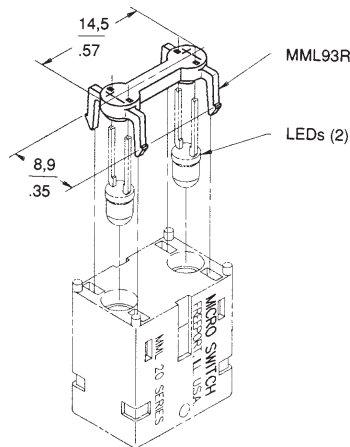

Manual Switches

Miniature Manual Line

MOUNTING DIMENSIONS (For reference only)

PANEL CUTOUTS FOR PUSHBUTTON SWITCHES AND INDICATORS/RECTANGULAR TYPE

INDIVIDUAL SNAP-IN PANEL MOUNT

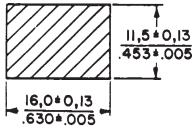

1.27 — 2.39
.050 — .094
Panel Thickness

PANEL PUNCH FOR MML SERIES

A panel punch is manufactured by Greenlee-Textron Tool Co., Rockford, IL (815-926-3011).

INDIVIDUAL PRINTED WIRING BOARD (PWB) MOUNT

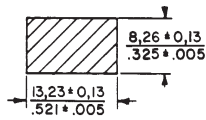

Pushbutton Plunger Thru Panel

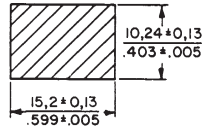

Housing Thru Panel

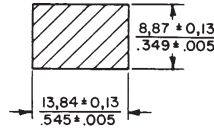

Indicator Lens Thru Panel

MULTI-UNIT PRINTED WIRING BOARD (PWB) MOUNT

Horizontal Mount

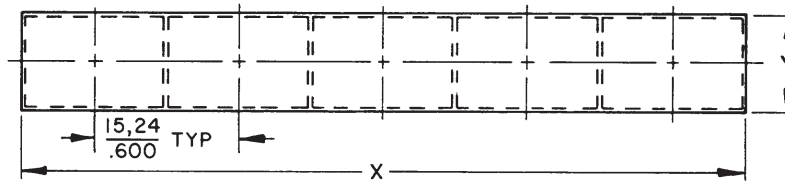
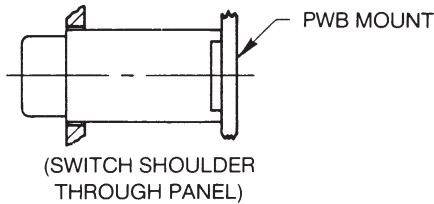

Establish tooling holes on X coordinate and use these holes to establish relationship between PWB and Panel

$$\text{Terminals } \frac{0.20}{.008} \times \frac{0.76}{.030}$$

Recommended hole size in PWB $\frac{1.17}{.046}$

$$\begin{aligned} N &= \text{Number of switches} \\ X &= N-1 \times \frac{15.24}{.600} + \frac{15.11}{.595} \\ Y &= \frac{10.16}{.400} \end{aligned}$$

$$\begin{aligned} \text{Example: } N &= 5 \text{ Switches} \\ X &= 5-1 \times \frac{15.24}{.600} + \frac{15.11}{.595} \\ X &= \frac{76.07}{2.995} \end{aligned}$$

Vertical Mount

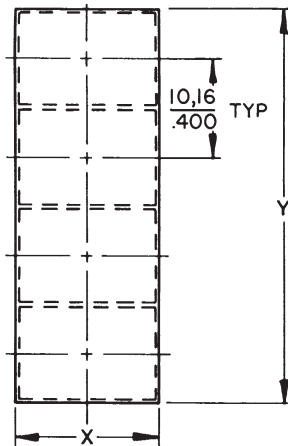

$$\begin{aligned} N &= \text{Number of Switches} \\ Y &= N \times \frac{10.16}{.400} \\ X &= \frac{15.11}{.595} \end{aligned}$$

$$\begin{aligned} \text{Example: } N &= 4 \\ Y &= 4 \times \frac{10.16}{.400} \\ Y &= \frac{40.64}{1.600} \end{aligned}$$

Manual Switches

Miniature Manual Line

MML Series

MOUNTING DIMENSIONS (For reference only)

PANEL CUTOUTS FOR PUSHBUTTON SWITCHES AND INDICATORS/SQUARE TYPE

Individual Snap-in Panel Mount

Individual Printed Wiring Board PWB Mount

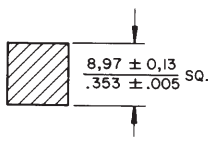
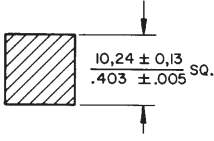
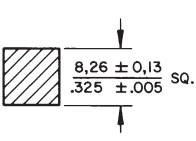
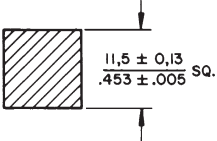

Pushbutton Plunger Thru Panel

Housing Thru Panel

Indicator Lens Thru Panel

See page 77 for panel punch manufacturer.

MULTI-UNIT PRINTED WIRING BOARD (PWB) MOUNT

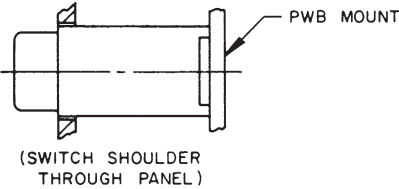

Establish tooling holes on X coordinate and use these holes to establish relationship between PWB and Panel

$$\text{Terminals } \frac{0,20}{.008} \times \frac{0,76}{.030}$$

Recommended hole size in PWB $\frac{1,17}{.046}$

Horizontal Mounting

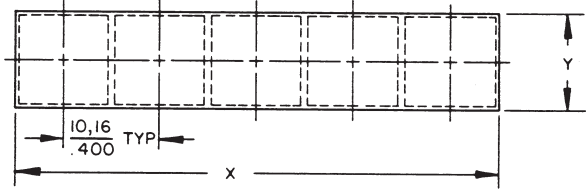

Formula:
 N = Number of switches
 $X = N \times \frac{10,16}{.400}$
 $Y = \frac{10,16}{.400}$

Example: N = 5 Switches
 $X = 5 \times \frac{10,16}{.400}$
 $X = \frac{50,80}{2.00}$

Vertical Mounting

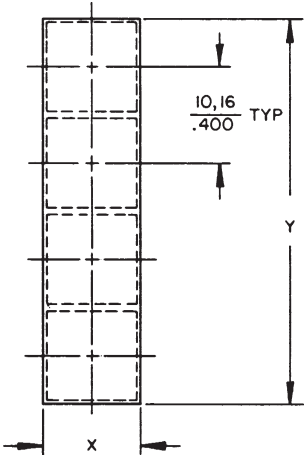

N = Number of Switches
 Formula: $Y = N \times \frac{10,16}{.400}$
 $X = \frac{10,16}{.400}$

Example: N = 4
 $Y = 4 \times \frac{10,16}{.400}$
 $Y = \frac{40,64}{1.600}$

Manual Switches

Miniature Manual Line

MOUNTING DIMENSIONS (For reference only)

PRINTED WIRING BOARD MOUNT PUSHBUTTON SWITCHES/RECTANGULAR TYPE

MML11 Switches

PWB Pin Locations

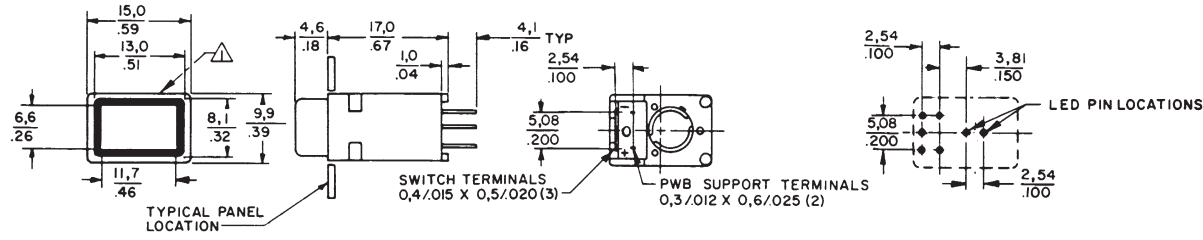

PWB Receptacle Installed (LED or Incandescent Lamp)

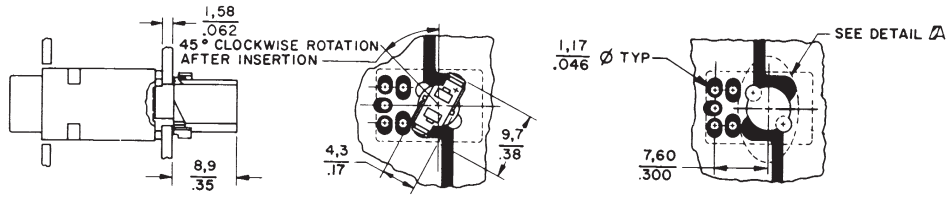

MML21 Switches

PWB Pin Locations

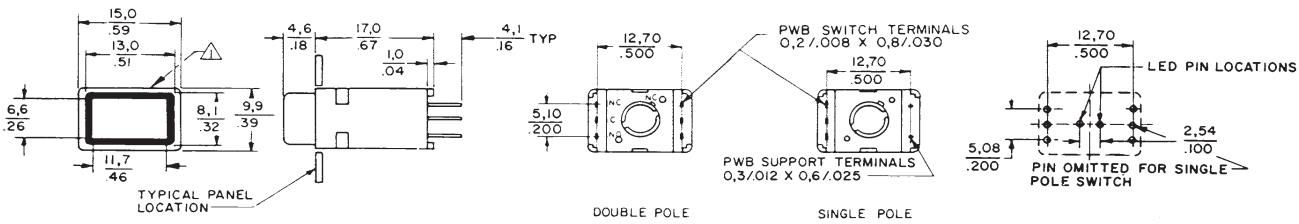

PWB Receptacle Installed (LED or Incandescent Lamp)

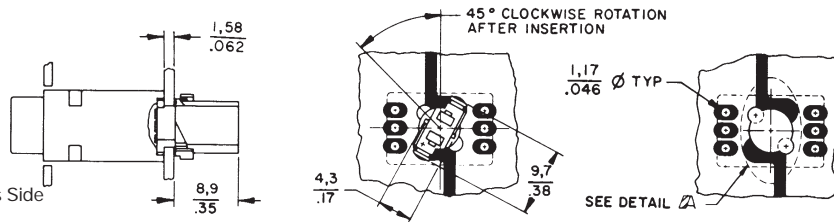

Notes:

△ MICRO SWITCH Identification This Side
 2 - Linear measure mm/IN. or $\frac{mm}{IN.}$

MML31 Switches

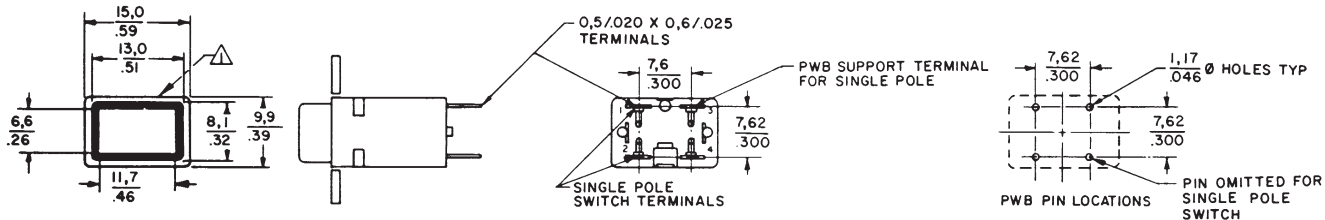

Manuals

Manual Switches

Miniature Manual Line

MML Series

MOUNTING DIMENSIONS (For reference only)

PRINTED WIRING BOARD MOUNT INDICATORS/RECTANGULAR TYPE

MML41 Indicators



PWB Receptacle Installed (LED or Incandescent Lamp)

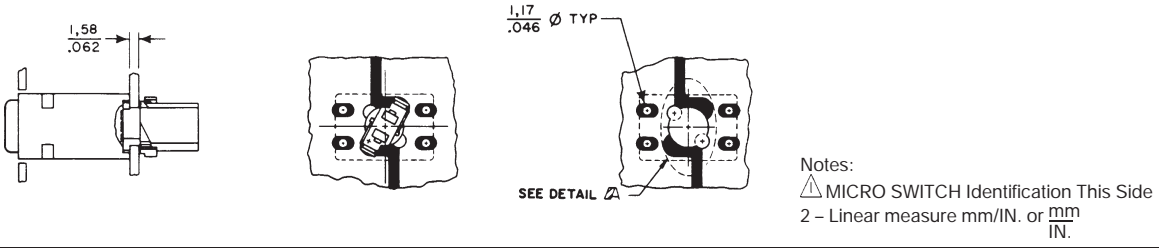

MML46 Indicators

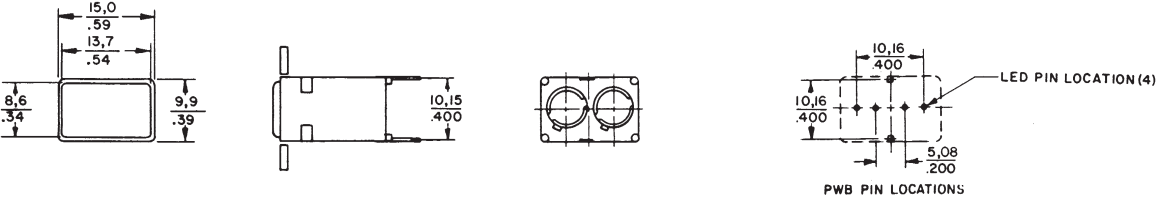

PWB Receptacle Installed (LED or Incandescent Lamp)

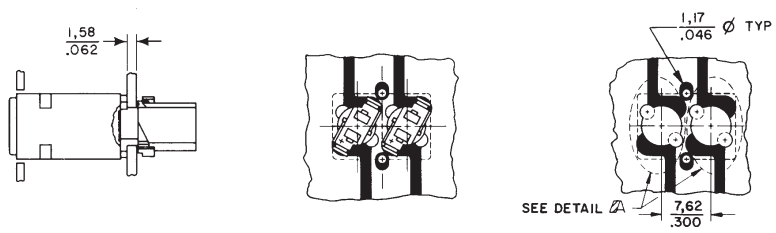

PWB Pad Location For Receptacle (LED or Incandescent Lamp)

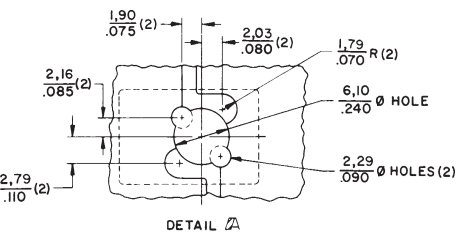

Manual Switches

Miniature Manual Line

MML Series

MOUNTING DIMENSIONS (For reference only)

PANEL MOUNT PUSHBUTTON SWITCHES/RECTANUGLAR TYPE

MML21 Switches

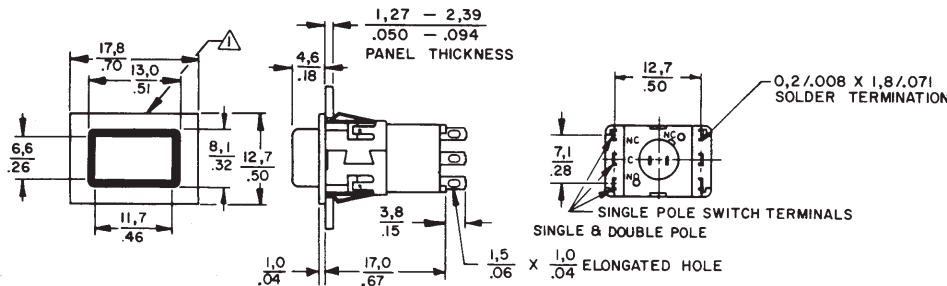

Solder Receptacle Installed (LED or Incandescent Lamp)



- Notes:
- △ MICRO SWITCH Identification This Side
 - 2 - Linear measure mm/IN. or $\frac{mm}{IN}$
 - 3 Rotate 45° counter clockwise for removal from switch or indicator

MML31 Switches

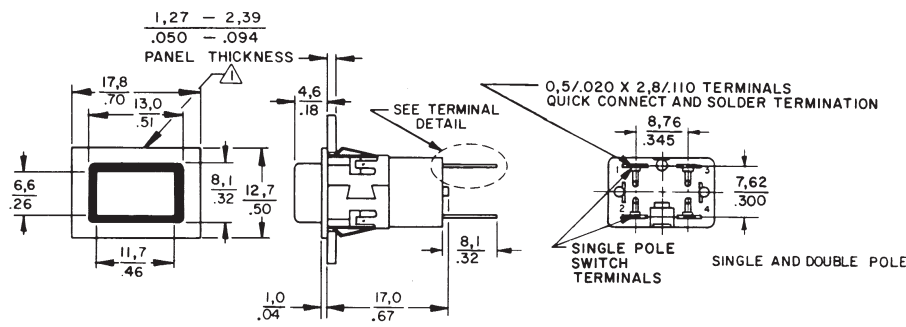

Terminal Detail

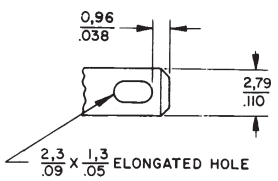

Manuals

Manual Switches

Miniature Manual Line

MOUNTING DIMENSIONS (For reference only)

PANEL MOUNT INDICATORS/RECTANGULAR TYPE

MML41 Indicators

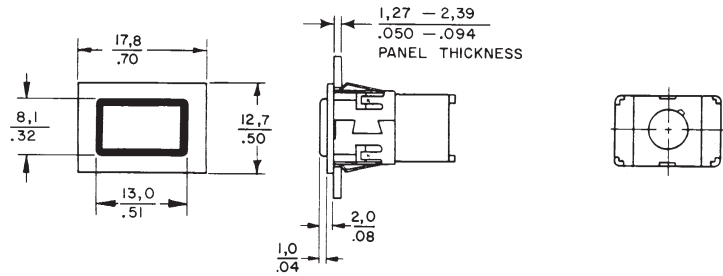

Solder Receptacle Installed (LED or Incandescent Lamp)

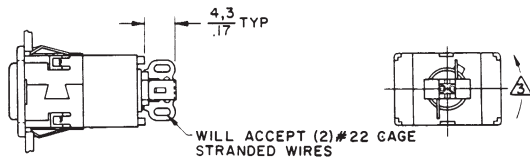

MML43 Indicators

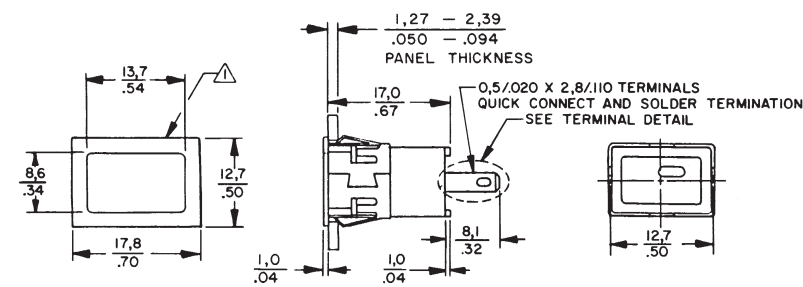

Terminal Detail

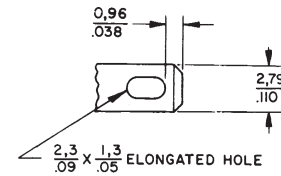

Notes:
 △ MICRO SWITCH Identification This Side
 2 - Linear measure mm/IN. or $\frac{\text{mm}}{\text{IN.}}$

MML46 Indicators

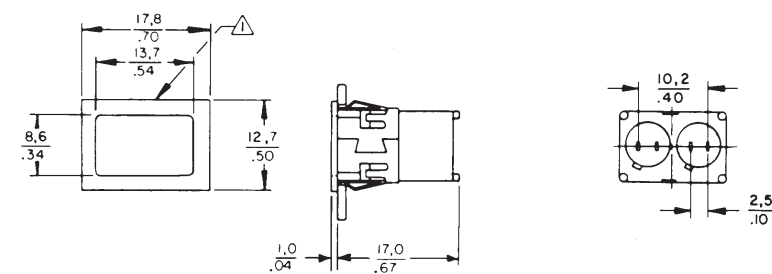

Solder Receptacle Installed (LED or Incandescent Lamp)

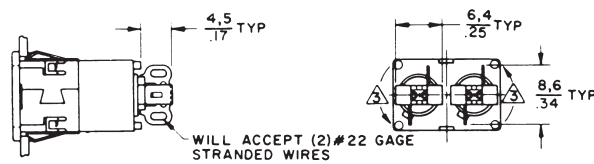

Manual Switches

Miniature Manual Line

MOUNTING DIMENSIONS (For reference only)

PRINTED WIRING BOARD MOUNT PUSHBUTTON SWITCHES AND INDICATORS/SQUARE TYPE

MML21 Switches

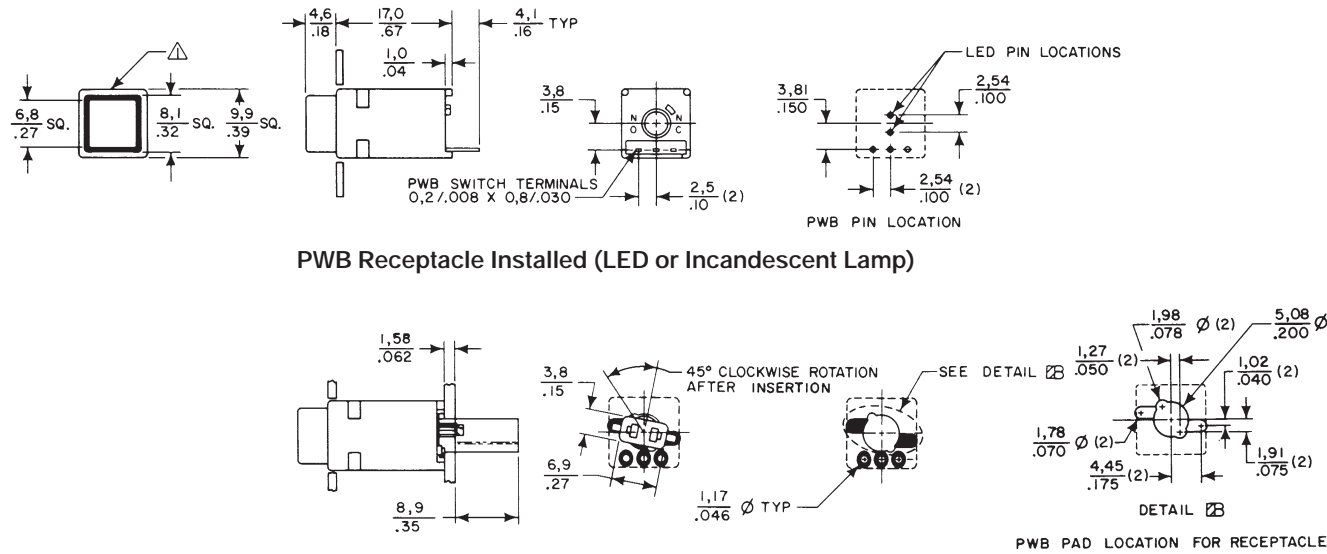

MML46 Indicators

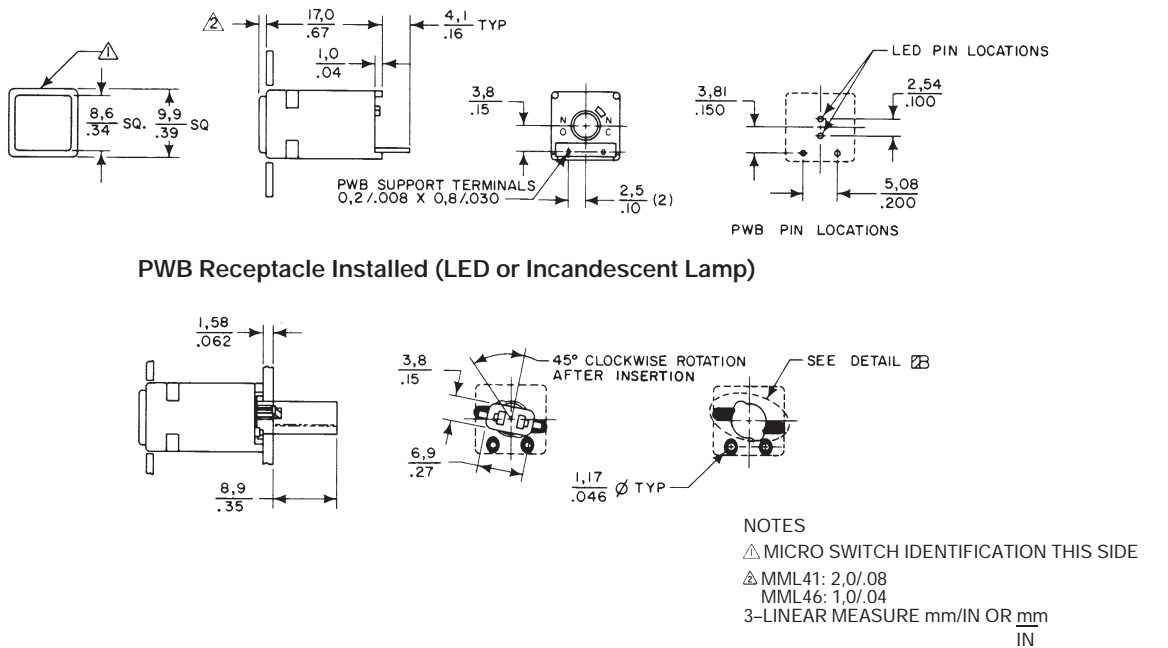

Manuals

PANEL MOUNT PUSHBUTTON SWITCHES/SQUARE TYPE

MML21 Switches

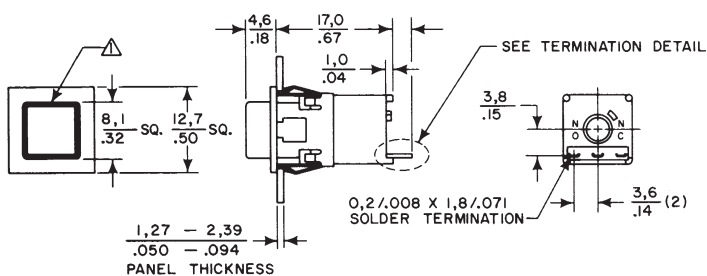

Termination Detail

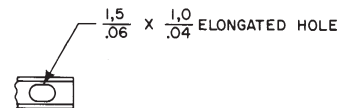

NOTE:
To install LED or lamp, use MML93L receptacle shown on page 76.

Manual Switches

Miniature Manual Line

MOUNTING DIMENSIONS (For reference only)

LENSES

Rectangular Pushbutton Lens

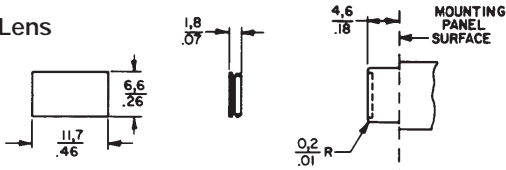

Rectangular Indicator Lens

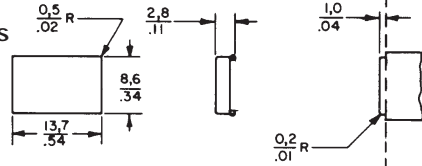

Square Pushbutton Lens

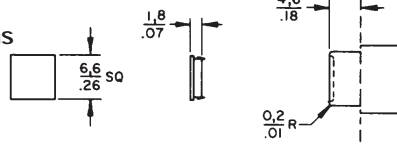

Square Indicator Lens

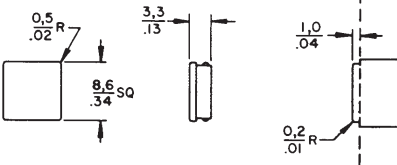

PWB SUPPORT BRACKETS

Rectangular

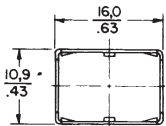

Square

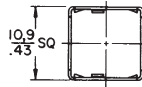

MML SERIES SWITCH TYP

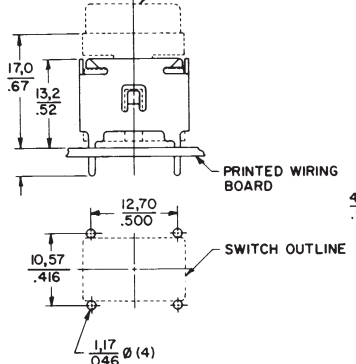

RECOMENDED PRINTED WIRING BOARD LAYOUT

MML SERIES SWITCH TYP

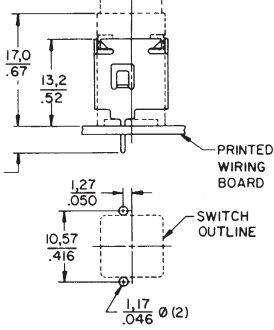

RECOMENDED PRINTED WIRING BOARD LAYOUT

Manual Switches

Miniature Manual Line

MML Series

MOUNTING DIMENSIONS (For reference only)

PANEL CUTOUTS FOR PWB MOUNT PADDLE AND ROCKER SWITCHES

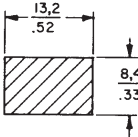

Actuator Thru Panel

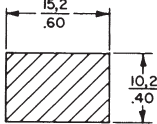

Housing Thru Panel

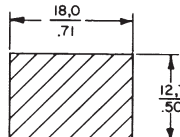

2-Pole MML33, 34 Actuator

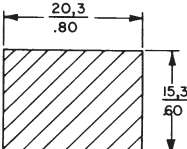

2-Pole MML33, 34 Thru Panel

Housing Thru Panel

See page 77 for panel punch manufacturer.

MML24 Rocker Switches

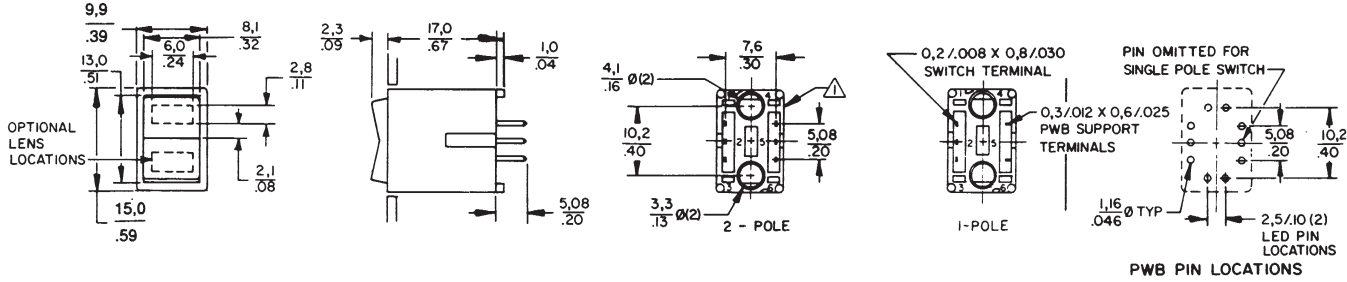

With PWB Receptacle Installed (LED or Incandescent Lamp)

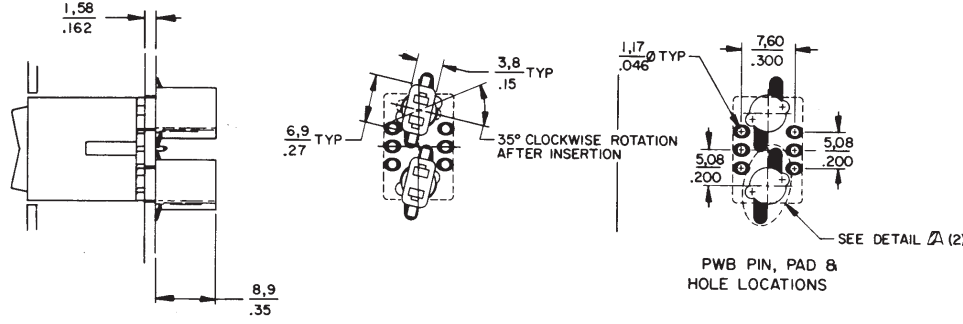

Notes:
 △ MICRO SWITCH Identification This Side
 2 - Linear measure mm/IN. or $\frac{mm}{IN}$.

Manuals

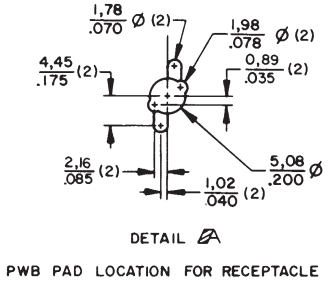

Manual Switches

Miniature Manual Line

MML Series

MOUNTING DIMENSIONS (For reference only)

PANEL MOUNT ROCKER SWITCHES

MML24 Rocker Switches

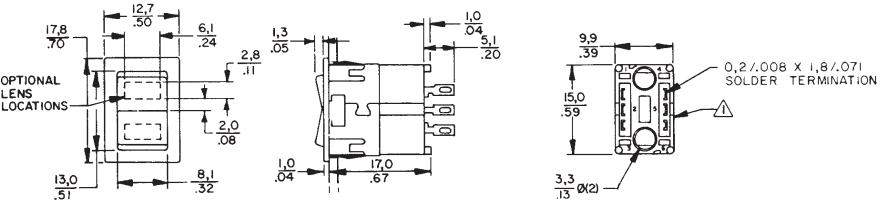

Notes:
 △ MICRO SWITCH Identification This Side
 2 – Linear measure mm/IN. or $\frac{mm}{IN}$.
 NOTE:
 To install LED or lamp, use MML93R receptacle shown on page 75.

Компания «Life Electronics» занимается поставками электронных компонентов импортного и отечественного производства от производителей и со складов крупных дистрибьюторов Европы, Америки и Азии.

С конца 2013 года компания активно расширяет линейку поставок компонентов по направлению коаксиальный кабель, кварцевые генераторы и конденсаторы (керамические, пленочные, электролитические), за счёт заключения дистрибьюторских договоров

Мы предлагаем:

- Конкурентоспособные цены и скидки постоянным клиентам.
- Специальные условия для постоянных клиентов.
- Подбор аналогов.
- Поставку компонентов в любых объемах, удовлетворяющих вашим потребностям.
- Приемлемые сроки поставки, возможна ускоренная поставка.
- Доставку товара в любую точку России и стран СНГ.
- Комплексную поставку.
- Работу по проектам и поставку образцов.
- Формирование склада под заказчика.
- Сертификаты соответствия на поставляемую продукцию (по желанию клиента).
- Тестирование поставляемой продукции.
- Поставку компонентов, требующих военную и космическую приемку.
- Входной контроль качества.
- Наличие сертификата ISO.

В составе нашей компании организован Конструкторский отдел, призванный помогать разработчикам, и инженерам.

Конструкторский отдел помогает осуществить:

- Регистрацию проекта у производителя компонентов.
- Техническую поддержку проекта.
- Защиту от снятия компонента с производства.
- Оценку стоимости проекта по компонентам.
- Изготовление тестовой платы монтаж и пусконаладочные работы.



Тел: +7 (812) 336 43 04 (многоканальный)
Email: org@lifeelectronics.ru