

## IR Receiver Modules for Remote Control Systems

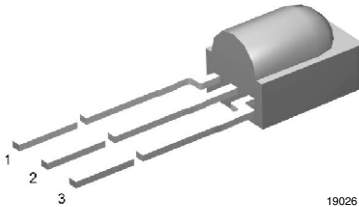

19026

### MECHANICAL DATA

#### Pinning:

1 = OUT, 2 = GND, 3 =  $V_S$

### FEATURES

- Low supply current
- Photo detector and preamplifier in one package
- Internal filter for PCM frequency
- Improved shielding against EMI
- Supply voltage: 2.7 V to 5.5 V
- Improved immunity against ambient light
- Insensitive to supply voltage ripple and noise
- Component in accordance to RoHS 2002/95/EC and WEEE 2002/96/EC



### DESCRIPTION

The TSOP582.., TSOP584.. series are miniaturized receivers for infrared remote control systems. A PIN diode and a preamplifier are assembled on a lead frame, the epoxy package acts as an IR filter.

The demodulated output signal can be directly decoded by a microprocessor. The TSOP582.. is compatible with all common IR remote control data formats. The TSOP584.. is optimized to suppress almost all spurious pulses from energy saving fluorescent lamps but will also suppress some data signals.

This component has not been qualified according to automotive specifications.

PARTS TABLE		
CARRIER FREQUENCY	STANDARD APPLICATIONS (AGC2/AGC8)	VERY NOISY ENVIROMENTS (AGC4)
30 kHz	TSOP58230	
33 kHz	TSOP58233	
36 kHz	TSOP58236	
36.7 kHz	TSOP58237	
38 kHz	TSOP58238	TSOP58438
40 kHz	TSOP58240	
56 kHz	TSOP58256	

### BLOCK DIAGRAM

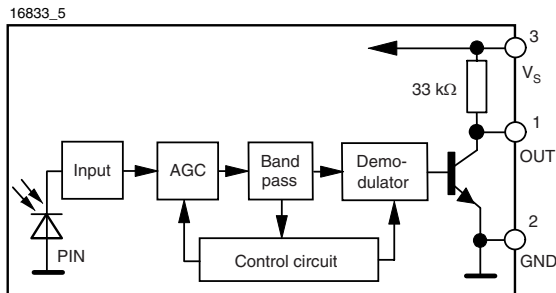

### APPLICATION CIRCUIT

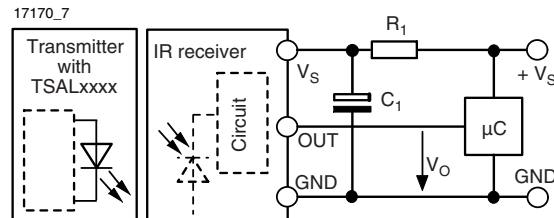

The external components  $R_1$  and  $C_1$  are optional to improve the robustness against electrical overstress (typical values are  $R_1 = 100 \Omega$ ,  $C_1 = 0.1 \mu F$ ). The output voltage  $V_O$  should not be pulled down to a level below 1 V by the external circuit. The capacitive load at the output should be less than 2 nF.



ABSOLUTE MAXIMUM RATINGS <sup>(1)</sup>				
PARAMETER	TEST CONDITION	SYMBOL	VALUE	UNIT
Supply voltage (pin 3)		$V_S$	- 0.3 to + 6.0	V
Supply current (pin 3)		$I_S$	5	mA
Output voltage (pin 1)		$V_O$	- 0.3 to 5.5	V
Voltage at output to supply		$V_S - V_O$	- 0.3 to $(V_S + 0.3)$	V
Output current (pin 1)		$I_O$	5	mA
Junction temperature		$T_j$	100	°C
Storage temperature range		$T_{stg}$	- 25 to + 85	°C
Operating temperature range		$T_{amb}$	- 25 to + 85	°C
Power consumption	$T_{amb} \leq 85\text{ °C}$	$P_{tot}$	10	mW
Soldering temperature	$t \leq 10\text{ s}$ , 1 mm from case	$T_{sd}$	260	°C

**Note**

<sup>(1)</sup> Stresses beyond those listed under “Absolute Maximum Ratings” may cause permanent damage to the device. This is a stress rating only and functional operation of the device at these or any other conditions beyond those indicated in the operational sections of this specification is not implied. Exposure to absolute maximum rating conditions for extended periods may affect the device reliability.

ELECTRICAL AND OPTICAL CHARACTERISTICS <sup>(1)</sup>						
PARAMETER	TEST CONDITION	SYMBOL	MIN.	TYP.	MAX.	UNIT
Supply current (pin 3)	$E_v = 0, V_S = 5\text{ V}$	$I_{SD}$	0.65	0.85	1.05	mA
	$E_v = 40\text{ klx}$ , sunlight	$I_{SH}$		0.95		mA
Supply voltage		$V_S$	2.7		5.5	V
Transmission distance	$E_v = 0$ , test signal see fig. 1, IR diode TSAL6200, $I_F = 400\text{ mA}$	$d$		40		m
Output voltage low (pin 1)	$I_{OSL} = 0.5\text{ mA}$ , $E_e = 0.7\text{ mW/m}^2$ , test signal see fig. 1	$V_{OSL}$			100	mV
Minimum irradiance	Pulse width tolerance: $t_{pi} - 5/f_0 < t_{po} < t_{pi} + 6/f_0$ , test signal see fig. 1	$E_e\text{ min.}$		0.3	0.45	$\text{mW/m}^2$
Maximum irradiance	$t_{pi} - 5/f_0 < t_{po} < t_{pi} + 6/f_0$ , test signal see fig. 1	$E_e\text{ max.}$	30			$\text{W/m}^2$
Directivity	Angle of half transmission distance	$\phi_{1/2}$		$\pm 45$		deg

**Note**

<sup>(1)</sup>  $T_{amb} = 25\text{ °C}$ , unless otherwise specified

**TYPICAL CHARACTERISTICS**

$T_{amb} = 25\text{ °C}$ , unless otherwise specified

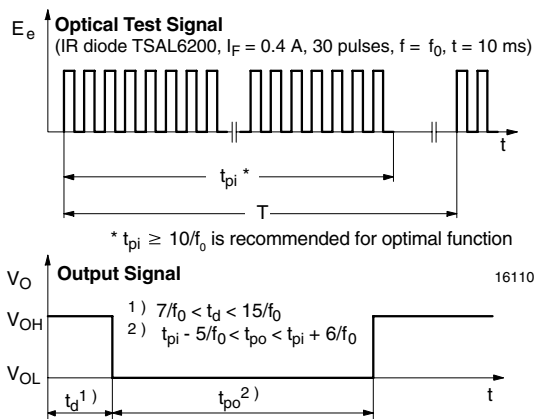

Fig. 1 - Output Active Low

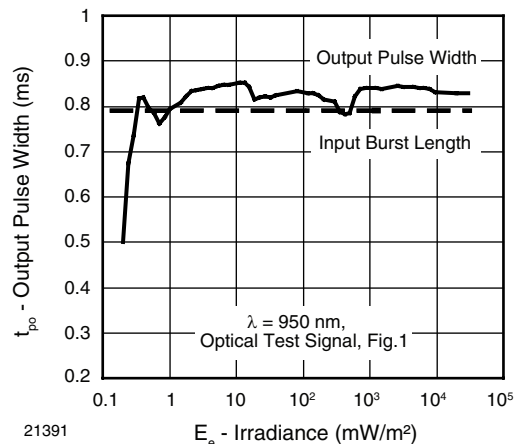

Fig. 2 - Pulse Length and Sensitivity in Dark Ambient

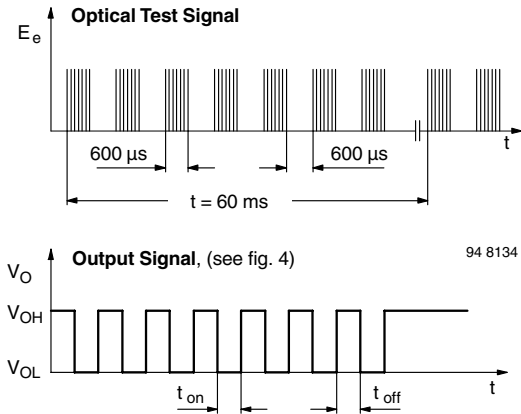

Fig. 3 - Output Function

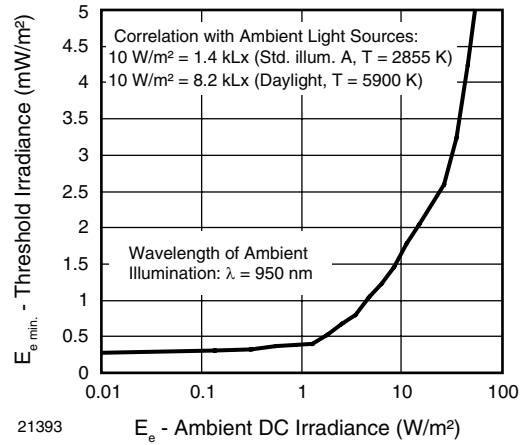

Fig. 6 - Sensitivity in Bright Ambient

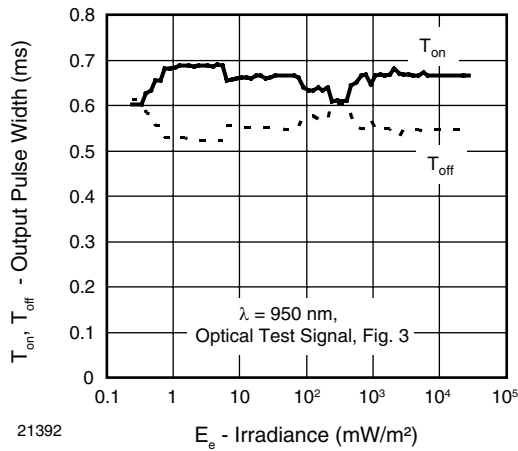

Fig. 4 - Output Pulse Diagram

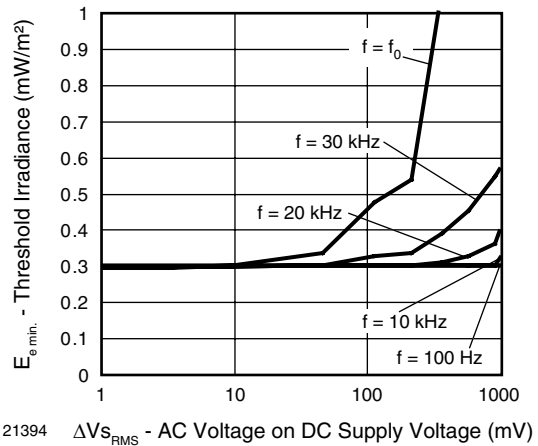

Fig. 7 - Sensitivity vs. Supply Voltage Disturbances

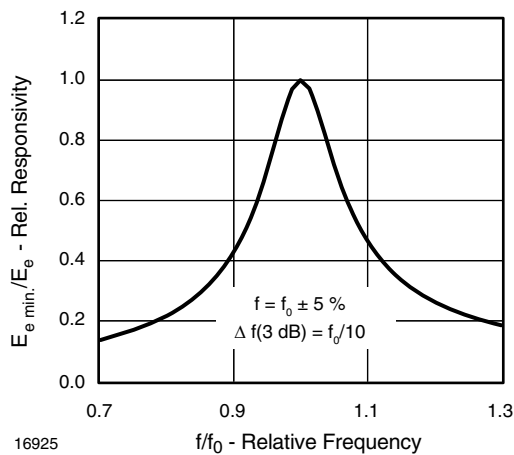

Fig. 5 - Frequency Dependence of Responsivity

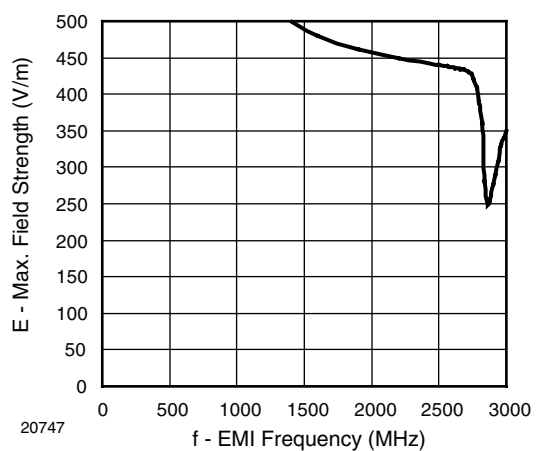
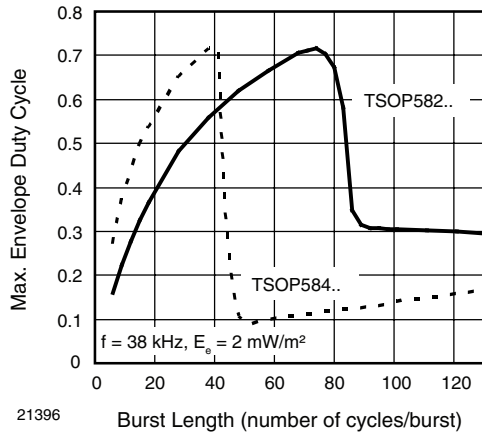
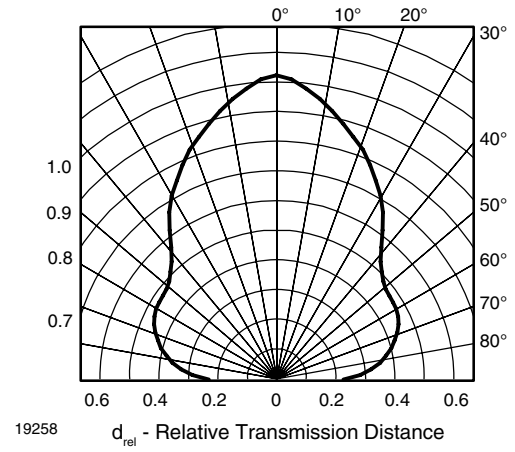

Fig. 8 - Sensitivity vs. Electric Field Disturbances



21396  
Burst Length (number of cycles/burst)  
Fig. 9 - Max. Envelope Duty Cycle vs. Burst Length



19258  
 $d_{rel}$  - Relative Transmission Distance  
Fig. 12 - Horizontal Directivity

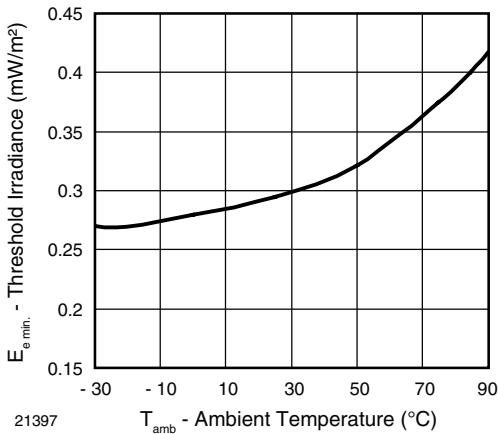

21397  
 $T_{amb}$  - Ambient Temperature ( $^{\circ}\text{C}$ )  
Fig. 10 - Sensitivity vs. Ambient Temperature

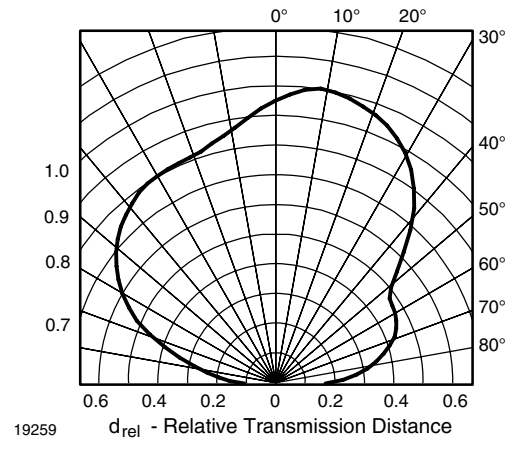

19259  
 $d_{rel}$  - Relative Transmission Distance  
Fig. 13 - Vertical Directivity

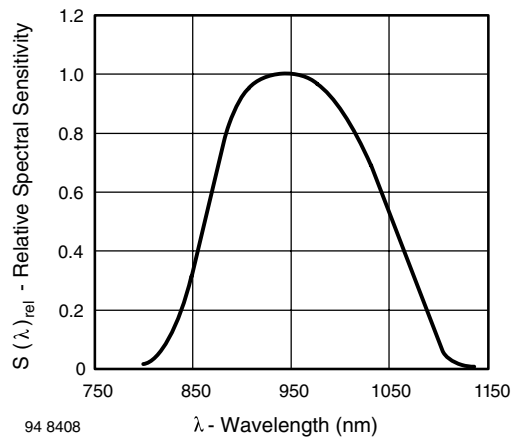

94 8408  
 $\lambda$  - Wavelength (nm)  
Fig. 11 - Relative Spectral Sensitivity vs. Wavelength

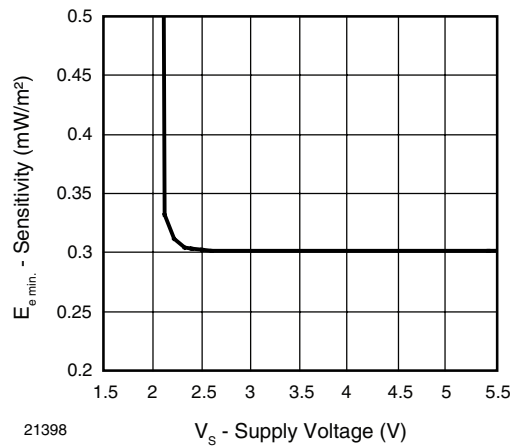

21398  
 $V_s$  - Supply Voltage (V)  
Fig. 14 - Sensitivity vs. Supply Voltage

## SUITABLE DATA FORMAT

The TSOP582.., TSOP584.. series are designed to suppress spurious output pulses due to noise or disturbance signals. Data and disturbance signals can be distinguished by the devices according to carrier frequency, burst length and envelope duty cycle. The data signal should be close to the band-pass center frequency (e.g. 38 kHz) and fulfill the conditions in the table below.

When a data signal is applied to the TSOP582.., TSOP584.. in the presence of a disturbance signal, the sensitivity of the receiver is reduced to insure that no spurious pulses are present at the output. Some examples of disturbance signals which are suppressed are:

- DC light (e.g. from tungsten bulb or sunlight)
- Continuous signals at any frequency
- Strongly or weakly modulated noise from fluorescent lamps with electronic ballasts (see figure 15 or figure 16)

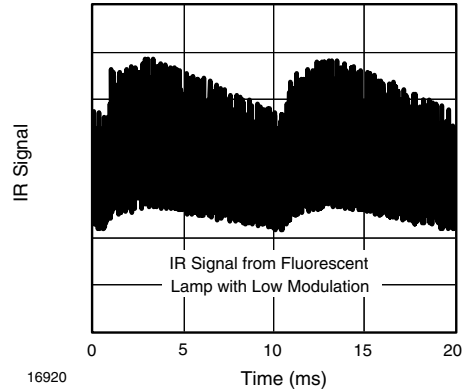

Fig. 15 - IR Signal from Fluorescent Lamp with Low Modulation

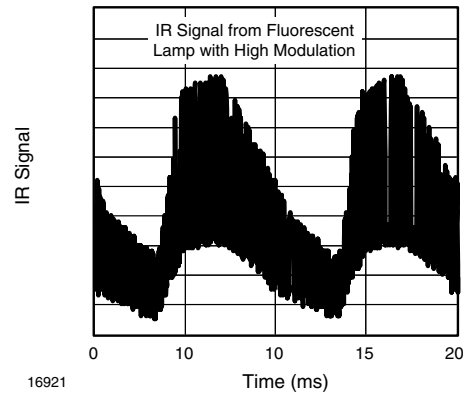

Fig. 16 - IR Signal from Fluorescent Lamp with High Modulation

	TSOP582..	TSOP584..
Minimum burst length	10 cycles/burst	10 cycles/burst
After each burst of length a minimum gap time is required of	10 to 70 cycles ≥ 12 cycles	10 to 35 cycles ≥ 12 cycles
For bursts greater than a minimum gap time in the data stream is needed of	70 cycles > 4 x burst length	35 cycles > 10 x burst length
Maximum number of continuous short bursts/second	800	1300
Compatible to NEC code	yes	yes
Compatible to RC5/RC6 code	yes	yes
Compatible to Sony code	yes	no
Compatible to Thomson 56 kHz code	yes	yes
Compatible to Mitsubishi code (38 kHz, preburst 8 ms, 16 bit)	yes	yes
Compatible to Sharp code	yes	yes
Suppression of interference from fluorescent lamps	Most common disturbance signals are suppressed	Even extreme disturbance signals are suppressed

### Note

For data formats with short bursts please see the data sheet of TSOP581..



**PACKAGE DIMENSIONS** in millimeters

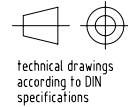
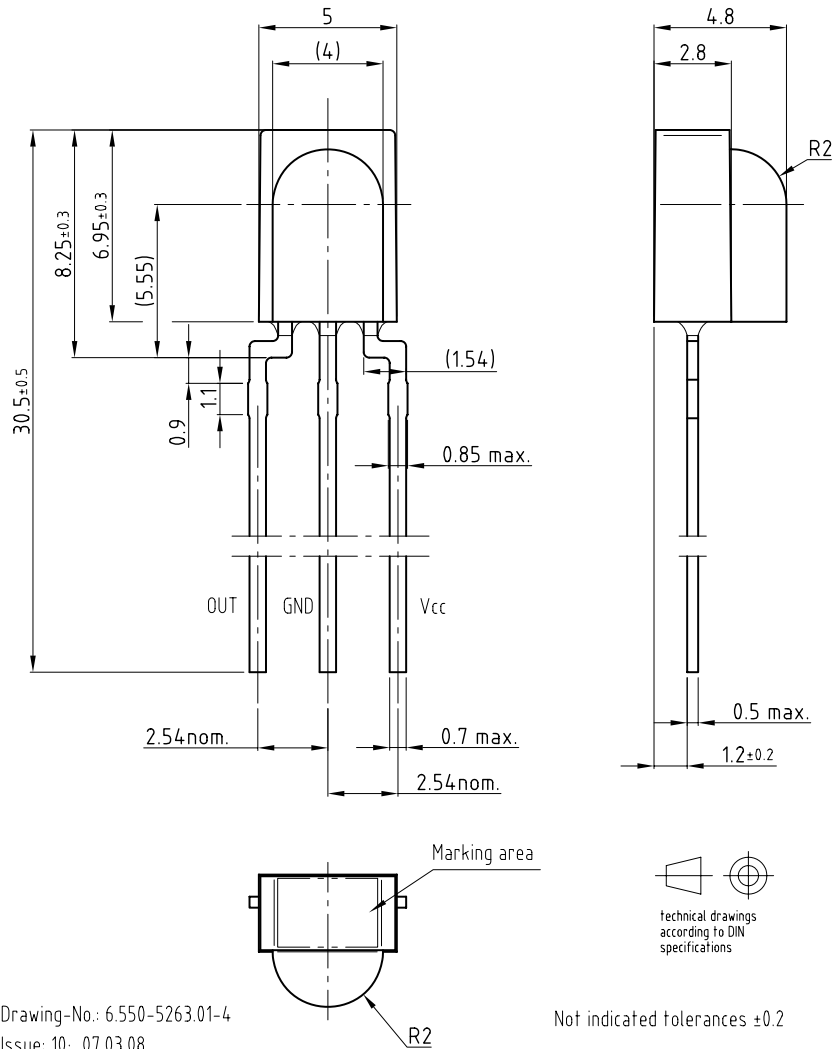

Technical drawings according to DIN specifications

Not indicated tolerances  $\pm 0.2$

Drawing-No.: 6.550-5263.01-4  
Issue: 10; 07.03.08

19009

## **OZONE DEPLETING SUBSTANCES POLICY STATEMENT**

It is the policy of Vishay Semiconductor GmbH to

1. Meet all present and future national and international statutory requirements.
2. Regularly and continuously improve the performance of our products, processes, distribution and operating systems with respect to their impact on the health and safety of our employees and the public, as well as their impact on the environment.

It is particular concern to control or eliminate releases of those substances into the atmosphere which are known as ozone depleting substances (ODSs).

The Montreal Protocol (1987) and its London Amendments (1990) intend to severely restrict the use of ODSs and forbid their use within the next ten years. Various national and international initiatives are pressing for an earlier ban on these substances.

Vishay Semiconductor GmbH has been able to use its policy of continuous improvements to eliminate the use of ODSs listed in the following documents.

1. Annex A, B and list of transitional substances of the Montreal Protocol and the London Amendments respectively.
2. Class I and II ozone depleting substances in the Clean Air Act Amendments of 1990 by the Environmental Protection Agency (EPA) in the USA.
3. Council Decision 88/540/EEC and 91/690/EEC Annex A, B and C (transitional substances) respectively.

Vishay Semiconductor GmbH can certify that our semiconductors are not manufactured with ozone depleting substances and do not contain such substances.

We reserve the right to make changes to improve technical design  
and may do so without further notice.

Parameters can vary in different applications. All operating parameters must be validated for each customer application by the customer. Should the buyer use Vishay Semiconductors products for any unintended or unauthorized application, the buyer shall indemnify Vishay Semiconductors against all claims, costs, damages, and expenses, arising out of, directly or indirectly, any claim of personal damage, injury or death associated with such unintended or unauthorized use.

Vishay Semiconductor GmbH, P.O.B. 3535, D-74025 Heilbronn, Germany



## Disclaimer

All product specifications and data are subject to change without notice.

Vishay Intertechnology, Inc., its affiliates, agents, and employees, and all persons acting on its or their behalf (collectively, "Vishay"), disclaim any and all liability for any errors, inaccuracies or incompleteness contained herein or in any other disclosure relating to any product.

Vishay disclaims any and all liability arising out of the use or application of any product described herein or of any information provided herein to the maximum extent permitted by law. The product specifications do not expand or otherwise modify Vishay's terms and conditions of purchase, including but not limited to the warranty expressed therein, which apply to these products.

No license, express or implied, by estoppel or otherwise, to any intellectual property rights is granted by this document or by any conduct of Vishay.

The products shown herein are not designed for use in medical, life-saving, or life-sustaining applications unless otherwise expressly indicated. Customers using or selling Vishay products not expressly indicated for use in such applications do so entirely at their own risk and agree to fully indemnify Vishay for any damages arising or resulting from such use or sale. Please contact authorized Vishay personnel to obtain written terms and conditions regarding products designed for such applications.

Product names and markings noted herein may be trademarks of their respective owners.



Компания «Life Electronics» занимается поставками электронных компонентов импортного и отечественного производства от производителей и со складов крупных дистрибьюторов Европы, Америки и Азии.

С конца 2013 года компания активно расширяет линейку поставок компонентов по направлению коаксиальный кабель, кварцевые генераторы и конденсаторы (керамические, пленочные, электролитические), за счёт заключения дистрибьюторских договоров

Мы предлагаем:

- Конкурентоспособные цены и скидки постоянным клиентам.
- Специальные условия для постоянных клиентов.
- Подбор аналогов.
- Поставку компонентов в любых объемах, удовлетворяющих вашим потребностям.
- Приемлемые сроки поставки, возможна ускоренная поставка.
- Доставку товара в любую точку России и стран СНГ.
- Комплексную поставку.
- Работу по проектам и поставку образцов.
- Формирование склада под заказчика.
- Сертификаты соответствия на поставляемую продукцию (по желанию клиента).
- Тестирование поставляемой продукции.
- Поставку компонентов, требующих военную и космическую приемку.
- Входной контроль качества.
- Наличие сертификата ISO.

В составе нашей компании организован Конструкторский отдел, призванный помогать разработчикам, и инженерам.

Конструкторский отдел помогает осуществить:

- Регистрацию проекта у производителя компонентов.
- Техническую поддержку проекта.
- Защиту от снятия компонента с производства.
- Оценку стоимости проекта по компонентам.
- Изготовление тестовой платы монтаж и пусконаладочные работы.



Тел: +7 (812) 336 43 04 (многоканальный)

Email: [org@lifeelectronics.ru](mailto:org@lifeelectronics.ru)