

# Precision SMD TCXO/VCTCXO

AST3TQ53



ESD Sensitive



RoHS/RoHS II Compliant



5.0 x 3.2 x 2.0mm

## Moisture Sensitivity Level (MSL) – 3

### FEATURES:

- Standard available frequencies: 10.00, 12.80, 16.384, 19.20, 19.44, 20.00, 24.576, 25.00, 26.00, 30.72, 40.00 MHz
- LVC MOS Output or Clipped Sine Wave output
- Frequency stabilities to include  $\pm 50$ ppb,  $\pm 100$ ppb and  $\pm 280$ ppb over  $-40^{\circ}\text{C}$  to  $+85^{\circ}\text{C}$  operating temperature range
- Excellent Phase Noise, Harmonics and Spurious content
- Typical rms jitter of 400fs @ 40MHz carrier & 1.0ps @ 10MHz carrier over 12kHz to 20MHz BW

### APPLICATIONS:

- COTS Military Radios & other Communication Hardware
- WiMax,
- LTE, BTS
- CATV, LAN, LMDS
- GPS Tracking with Hold-Over accuracy
- Test & Measurement Equipment
- Point-to-Point communication networks

### STANDARD SPECIFICATIONS:

#### Maximum Rating

| Parameters                | Rating        |
|---------------------------|---------------|
| Storage Temperature Range | -55 to +125°C |
| Supply Voltage            | -0.5 to 6V    |
| Control Voltage           | 0 to 3V       |
| ESD, HBM/CDM/MM           | 4kV/2kV/200V  |

#### Key Electrical Specifications

| Parameters   | Minimum   | Typical   | Maximum    | Units      | Notes  |
|--|---|-----------|------------|------------|--|
| Frequency Range  | 10  |           | 40         | MHz        |  |
| Standard Frequencies   | 10.00, 12.80, 16.384, 19.20, 19.44, 20.00, 24.576, 25.00, 26.00, 30.72, 40.00 |           |            | MHz        |  |
| Initial Frequency Tolerance (@+25°C) at shipping               |   |           | $\pm 0.5$  | ppm        | Relative to carrier                                    |
| <b>Frequency Stability Options (Ref. to Frequency @+25°C)</b>  |   |           |            |            |  |
| -40°C to +85°C   |   |           | $\pm 50$   | ppb        | Option "5"   |
| -40°C to +85°C   |   |           | $\pm 100$  | ppb        | Option "1"   |
| -40°C to +85°C   |   |           | $\pm 280$  | ppb        | Option "2"   |
| Frequency Stability vs. Supply Voltage Change (Vdd $\pm 5\%$ ) |   |           | $\pm 100$  | ppb        |  |
| Frequency Stability vs. Load Change (Load $\pm 5\%$ )          |   |           | $\pm 200$  | ppb        |  |
| Aging (first year @+25°C)                                      |   |           | $\pm 1.0$  | ppm        |  |
| Aging (20 years @+25°C)  |   | $\pm 3.0$ | $\pm 4.6$  | ppm        |  |
| Supply Voltage (Vdd)   | +3.135  | +3.3      | +3.465     | V          |  |
| Supply Current (Icc)   |   |           | 6.0        | mA         | No load  |
| <b>Control Port ( Applicable for VCTCXO only)</b>              |   |           |            |            |  |
| Control Voltage Range (Vc)                                     | +0.5  | +1.5      | +2.5       | V          |  |
| Center Control Voltage (Vc)                                    |   | +1.5      |            | V          | To be with-in $\pm 500$ ppb of Fc @ 25°C (at shipping) |
| Frequency Tuning Range   | $\pm 5$   | $\pm 7$   | $< \pm 13$ | ppm        |  |
| Tuning Slope   | Positive  |           |            |            |  |
| Linearity  |   |           | $\pm 1$    | %          |  |
| Port Impedance   | 100   |           |            | k $\Omega$ |  |

# Precision SMD TCXO/VCTCXO

AST3TQ53



ESD Sensitive



RoHS/RoHS II Compliant



5.0 x 3.2 x 2.0mm

## STANDARD SPECIFICATIONS:

(Continued)

| Parameters                                      | Minimum    | Typical | Maximum | Unites | Notes                                   |
|---|------------|---------|---------|--------|---|
| Phase Noise<br>(10MHz carrier frequency @25°C): |            |         | -95     | dBc/Hz | Offset @10Hz                            |
|   |            |         | -120    |        | Offset @100Hz                           |
|   |            |         | -140    |        | Offset @1kHz                            |
|   |            |         | -145    |        | Offset @10kHz                           |
|   |            |         | -150    |        | Offset @100kHz                          |
| RMS Jitter (@12kHz~5MHz BW)                     | 0.4        |         | 1.3     | ps     | Carrier Dependent                       |
| <b>Clipped Sine Wave</b>                        |            |         |         |        |   |
| Output Level                                    | 0.8        |         |         | Vp-p   |   |
| Output Load                                     | 10kΩ//10pF |         |         |        |   |
| <b>LVC MOS Output (Square Wave)</b>             |            |         |         |        |   |
| V <sub>OH</sub>                                 | 2.4        |         |         | V      | Output Load=15pF                        |
| V <sub>OL</sub>                                 |            |         | 0.4     | V      | Output Load=15pF                        |
| Output Load                                     |            |         | 15      | pF     |   |
| Duty Cycle                                      | 45         |         | 55      | %      | @(V <sub>OH</sub> - V <sub>OL</sub> )/2 |
| Rise/Fall Time                                  |            |         | 6       | ns     | Output Load=15pF                        |

## PART IDENTIFICATION:





AST3TQ53



ESD Sensitive



RoHS/RoHS II Compliant

## TYPICAL FREQUENCY STABILITY VS. TEMPERATURE



## TYPICAL SHORT TERM STABILITY





### TYPICAL FREQUENCY PULL VS. CONTROL VOLTAGE



### TYPICAL PHASE NOISE

#### 10.00 MHz Carrier



# Precision SMD TCXO/VCTCXO

AST3TQ53



ESD Sensitive



RoHS/RoHS II Compliant

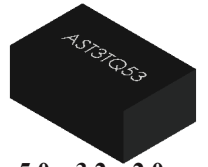

5.0 x 3.2 x 2.0mm

## TYPICAL AGING:

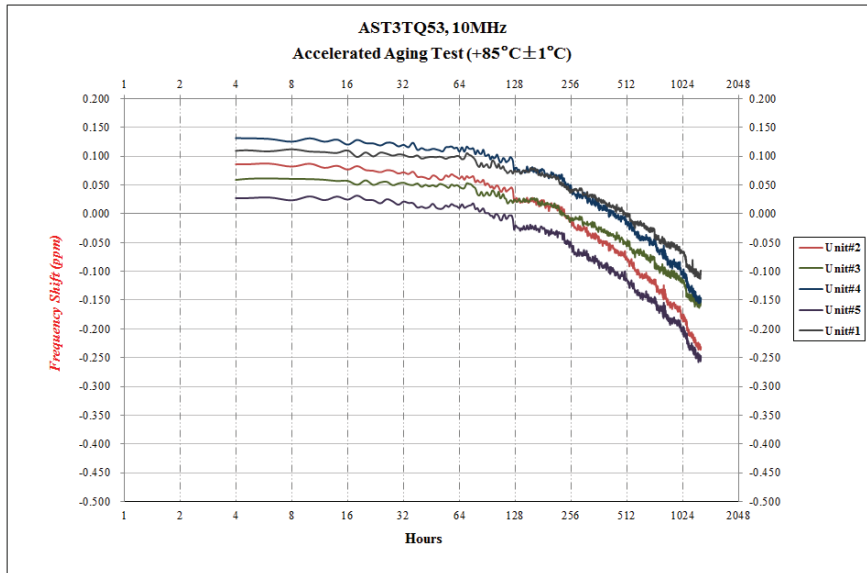

| Aging Test Conditions |             |
|-----------------------|-------------|
| Series                | AST3TQ53    |
| Frequency             | 10MHz       |
| Acquisition Mode      | Cycle       |
| Acquisition Time      | 1129 hours  |
| Test Temperature      | +85°C ± 1°C |
| Number of Samples     | 5pcs        |

| Aging Data |                  |                 |                            |
|------------|------------------|-----------------|----------------------------|
| No.        | Aging Time (hrs) | Aging/Day (ppm) | Projected Aging/year (ppm) |
| #1         | 1129             | -0.0039         | -0.3896                    |
| #2         | 1129             | -0.0059         | -0.5925                    |
| #3         | 1129             | -0.0042         | -0.4202                    |
| #4         | 1129             | -0.0056         | -0.5555                    |
| #5         | 1129             | -0.0055         | -0.5492                    |

## OUTLINE DIMENSION:

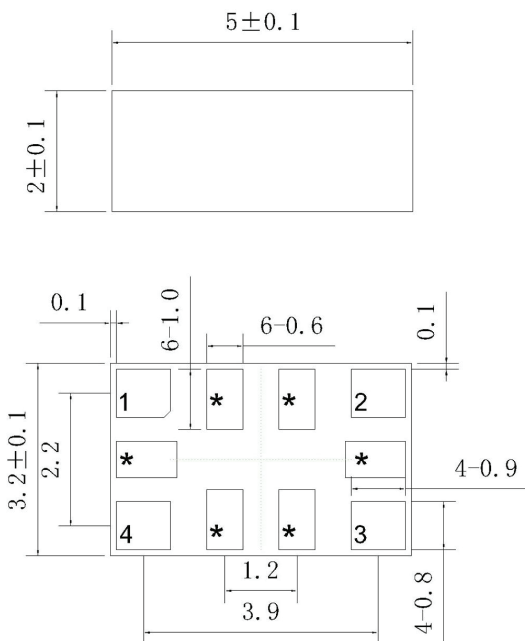

Dimensions: mm

## Recommended Land Pattern



| Pin | Function                         |
|-----|----------------------------------|
| 1   | NC (for TCXO)<br>Vc (for VCTCXO) |
| 2   | GND                              |
| 3   | Output                           |
| 4   | Vdd                              |
| *   | For factory test only            |

# Precision SMD TCXO/VCTCXO

AST3TQ53



ESD Sensitive



RoHS/RoHS II Compliant

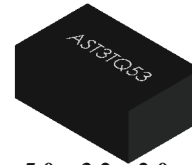

5.0 x 3.2 x 2.0mm

## REFLOW PROFILE:

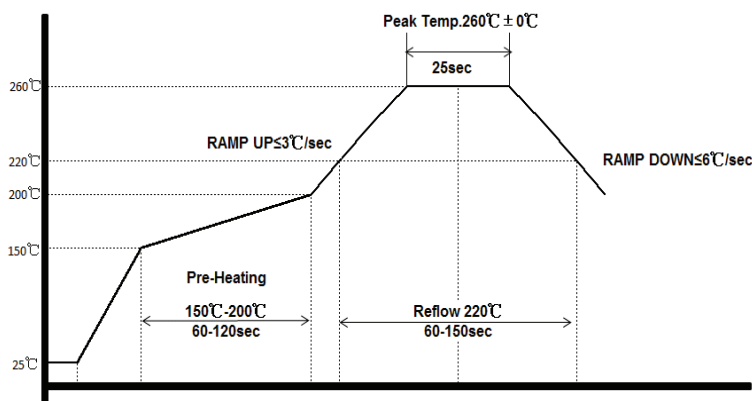

## TAPE & REEL:

**T5: 500pcs/reel; T2: 2000pcs/reel**

**MSL-3 packaging applies to MOQ=25 units (cut tape), T5 & T2.**

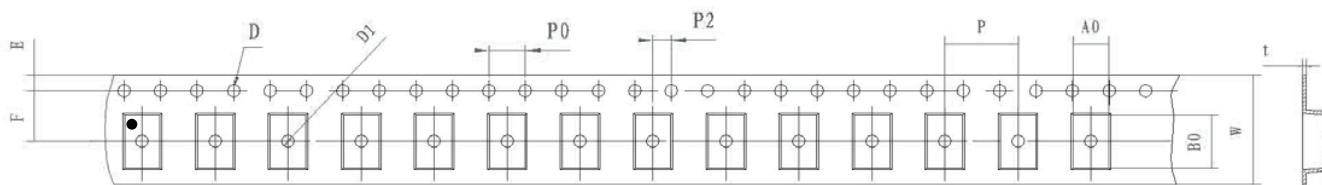

|          |              |              |          |         |          |
|----------|--------------|--------------|----------|---------|----------|
| W        | A0           | B0           | K0       | P       | F        |
| 16.0±0.3 | 3.7±0.15     | 5.6±0.15     | 2.0±0.15 | 8.0±0.1 | 7.5±0.1  |
| E        | D            | D1           | P0       | P2      | t        |
| 1.75±0.1 | 1.5+0.1/-0.0 | 1.5+0.1/-0.0 | 4.0±0.1  | 2.0±0.1 | 0.3±0.05 |

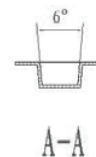

B-B

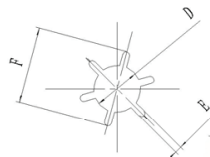
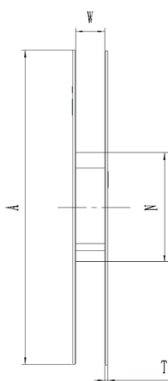
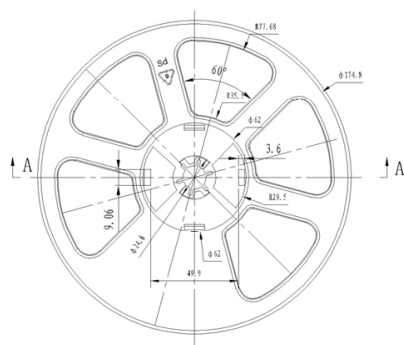

|          |         |        |         |         |          |          |
|----------|---------|--------|---------|---------|----------|----------|
| W        | A       | N      | T       | E       | F        | D        |
| 16.4±0.3 | 178±0.5 | 62±0.4 | 1.8±0.2 | 2.0±0.5 | 21.8±0.8 | 13.5±0.3 |

Dimensions: mm

**ATTENTION:** Abracon Corporation's products are COTS – Commercial-Off-The-Shelf products; suitable for Commercial, Industrial and, where designated, Automotive Applications. Abracon's products are not specifically designed for Military, Aviation, Aerospace, Life-dependant Medical applications or any application requiring high reliability where component failure could result in loss of life and/or property. For applications requiring high reliability and/or presenting an extreme operating environment, written consent and authorization from Abracon Corporation is required. Please contact Abracon Corporation for more information.

ABRACON IS  
ISO9001:2008  
CERTIFIED



2 Faraday, Suite# B | Irvine | CA 92618 **Revised: 04.02.15**

Ph. 949.546.8000 | Fax. 949.546.8001

Visit [www.abracon.com](http://www.abracon.com) for Terms and Conditions of Sale

Компания «Life Electronics» занимается поставками электронных компонентов импортного и отечественного производства от производителей и со складов крупных дистрибьюторов Европы, Америки и Азии.

С конца 2013 года компания активно расширяет линейку поставок компонентов по направлению коаксиальный кабель, кварцевые генераторы и конденсаторы (керамические, пленочные, электролитические), за счёт заключения дистрибьюторских договоров

Мы предлагаем:

- Конкурентоспособные цены и скидки постоянным клиентам.
- Специальные условия для постоянных клиентов.
- Подбор аналогов.
- Поставку компонентов в любых объемах, удовлетворяющих вашим потребностям.
- Приемлемые сроки поставки, возможна ускоренная поставка.
- Доставку товара в любую точку России и стран СНГ.
- Комплексную поставку.
- Работу по проектам и поставку образцов.
- Формирование склада под заказчика.
- Сертификаты соответствия на поставляемую продукцию (по желанию клиента).
- Тестирование поставляемой продукции.
- Поставку компонентов, требующих военную и космическую приемку.
- Входной контроль качества.
- Наличие сертификата ISO.

В составе нашей компании организован Конструкторский отдел, призванный помогать разработчикам, и инженерам.

Конструкторский отдел помогает осуществить:

- Регистрацию проекта у производителя компонентов.
- Техническую поддержку проекта.
- Защиту от снятия компонента с производства.
- Оценку стоимости проекта по компонентам.
- Изготовление тестовой платы монтаж и пусконаладочные работы.



Тел: +7 (812) 336 43 04 (многоканальный)

Email: [org@lifeelectronics.ru](mailto:org@lifeelectronics.ru)