

# Precision SMD TCXO/VCTCXO

AST3TQ53



ESD Sensitive



RoHS/RoHS II Compliant



5.0 x 3.2 x 2.0mm

## Moisture Sensitivity Level (MSL) – 3

### FEATURES:

- Standard available frequencies: 10.00, 12.80, 16.384, 19.20, 19.44, 20.00, 24.576, 25.00, 26.00, 30.72, 40.00 MHz
- LVC MOS Output or Clipped Sine Wave output
- Frequency stabilities to include  $\pm 50$ ppb,  $\pm 100$ ppb and  $\pm 280$ ppb over  $-40^{\circ}\text{C}$  to  $+85^{\circ}\text{C}$  operating temperature range
- Excellent Phase Noise, Harmonics and Spurious content
- Typical rms jitter of 400fs @ 40MHz carrier & 1.0ps @ 10MHz carrier over 12kHz to 20MHz BW

### APPLICATIONS:

- COTS Military Radios & other Communication Hardware
- WiMax,
- LTE, BTS
- CATV, LAN, LMDS
- GPS Tracking with Hold-Over accuracy
- Test & Measurement Equipment
- Point-to-Point communication networks

### STANDARD SPECIFICATIONS:

#### Maximum Rating

Parameters	Rating
Storage Temperature Range	-55 to +125°C
Supply Voltage	-0.5 to 6V
Control Voltage	0 to 3V
ESD, HBM/CDM/MM	4kV/2kV/200V

#### Key Electrical Specifications

Parameters	Minimum	Typical	Maximum	Units	Notes
Frequency Range	10		40	MHz	
Standard Frequencies	10.00, 12.80, 16.384, 19.20, 19.44, 20.00, 24.576, 25.00, 26.00, 30.72, 40.00			MHz	
Initial Frequency Tolerance (@+25°C) at shipping			$\pm 0.5$	ppm	Relative to carrier
<b>Frequency Stability Options (Ref. to Frequency @+25°C)</b>					
-40°C to +85°C			$\pm 50$	ppb	Option "5"
-40°C to +85°C			$\pm 100$	ppb	Option "1"
-40°C to +85°C			$\pm 280$	ppb	Option "2"
Frequency Stability vs. Supply Voltage Change (Vdd $\pm 5\%$ )			$\pm 100$	ppb	
Frequency Stability vs. Load Change (Load $\pm 5\%$ )			$\pm 200$	ppb	
Aging (first year @+25°C)			$\pm 1.0$	ppm	
Aging (20 years @+25°C)		$\pm 3.0$	$\pm 4.6$	ppm	
Supply Voltage (Vdd)	+3.135	+3.3	+3.465	V	
Supply Current (Icc)			6.0	mA	No load
<b>Control Port ( Applicable for VCTCXO only)</b>					
Control Voltage Range (Vc)	+0.5	+1.5	+2.5	V	
Center Control Voltage (Vc)		+1.5		V	To be with-in $\pm 500$ ppb of Fc @ 25°C (at shipping)
Frequency Tuning Range	$\pm 5$	$\pm 7$	$< \pm 13$	ppm	
Tuning Slope	Positive				
Linearity			$\pm 1$	%	
Port Impedance	100			k $\Omega$	

# Precision SMD TCXO/VCTCXO

AST3TQ53



ESD Sensitive



RoHS/RoHS II Compliant



5.0 x 3.2 x 2.0mm

## STANDARD SPECIFICATIONS:

(Continued)

Parameters	Minimum	Typical	Maximum	Unites	Notes
Phase Noise (10MHz carrier frequency @25°C):			-95	dBc/Hz	Offset @10Hz
			-120		Offset @100Hz
			-140		Offset @1kHz
			-145		Offset @10kHz
			-150		Offset @100kHz
RMS Jitter (@12kHz~5MHz BW)	0.4		1.3	ps	Carrier Dependent
<b>Clipped Sine Wave</b>					
Output Level	0.8			Vp-p	
Output Load	10kΩ//10pF				
<b>LVC MOS Output (Square Wave)</b>					
V <sub>OH</sub>	2.4			V	Output Load=15pF
V <sub>OL</sub>			0.4	V	Output Load=15pF
Output Load			15	pF	
Duty Cycle	45		55	%	@(V <sub>OH</sub> - V <sub>OL</sub> )/2
Rise/Fall Time			6	ns	Output Load=15pF

## PART IDENTIFICATION:





### TYPICAL FREQUENCY STABILITY VS. TEMPERATURE



### TYPICAL SHORT TERM STABILITY





### TYPICAL FREQUENCY PULL VS. CONTROL VOLTAGE



### TYPICAL PHASE NOISE

#### 10.00 MHz Carrier



# Precision SMD TCXO/VCTCXO

AST3TQ53



ESD Sensitive



RoHS/RoHS II Compliant



5.0 x 3.2 x 2.0mm

## TYPICAL AGING:



Aging Test Conditions	
Series	AST3TQ53
Frequency	10MHz
Acquisition Mode	Cycle
Acquisition Time	1129 hours
Test Temperature	+85°C ± 1°C
Number of Samples	5pcs

Aging Data			
No.	Aging Time (hrs)	Aging/Day (ppm)	Projected Aging/year (ppm)
#1	1129	-0.0039	-0.3896
#2	1129	-0.0059	-0.5925
#3	1129	-0.0042	-0.4202
#4	1129	-0.0056	-0.5555
#5	1129	-0.0055	-0.5492

## OUTLINE DIMENSION:

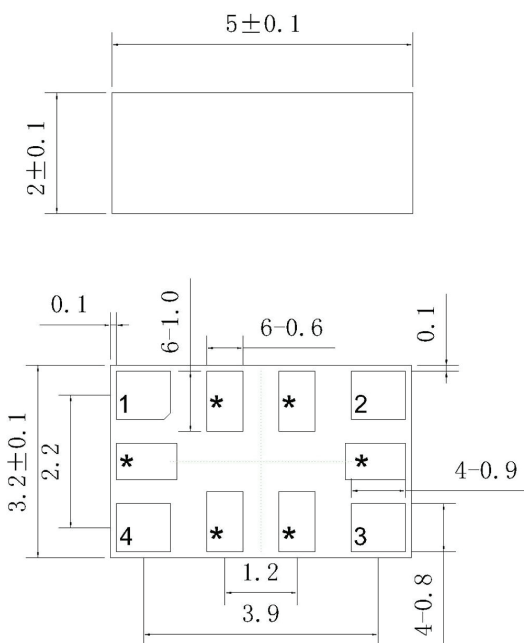

Dimensions: mm

## Recommended Land Pattern



Pin	Function
1	NC (for TCXO) Vc (for VCTCXO)
2	GND
3	Output
4	Vdd
*	For factory test only

# Precision SMD TCXO/VCTCXO



5.0 x 3.2 x 2.0mm

AST3TQ53



ESD Sensitive



RoHS/RoHS II Compliant

## REFLOW PROFILE:

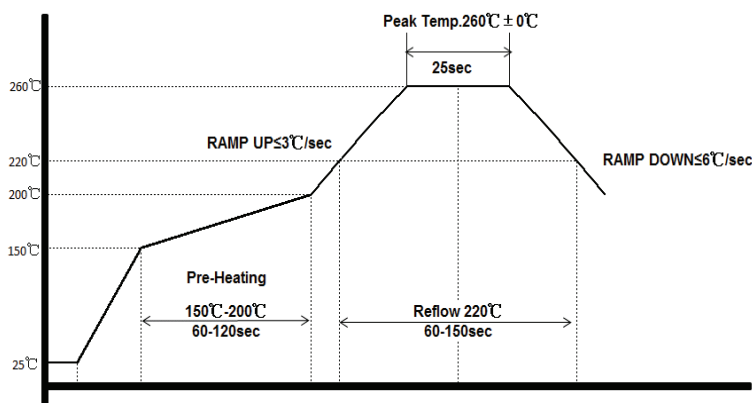

## TAPE & REEL:

T5: 500pcs/reel; T2: 2000pcs/reel

MSL-3 packaging applies to MOQ=25 units (cut tape), T5 & T2.

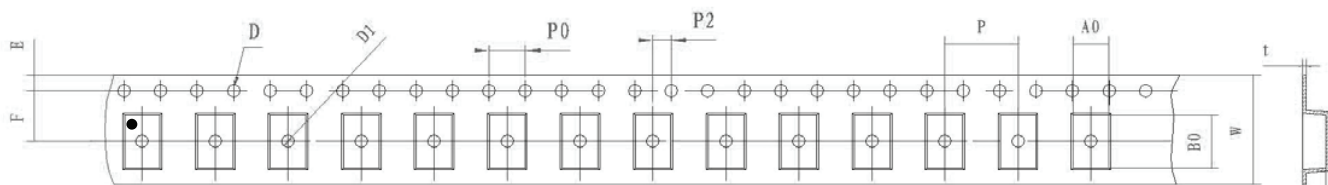

W	A0	B0	K0	P	F
16.0±0.3	3.7±0.15	5.6±0.15	2.0±0.15	8.0±0.1	7.5±0.1
E	D	D1	P0	P2	t
1.75±0.1	1.5+0.1/-0.0	1.5+0.1/-0.0	4.0±0.1	2.0±0.1	0.3±0.05

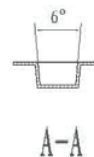

B-B

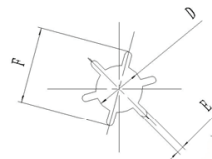
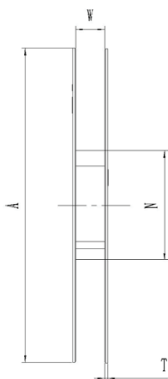
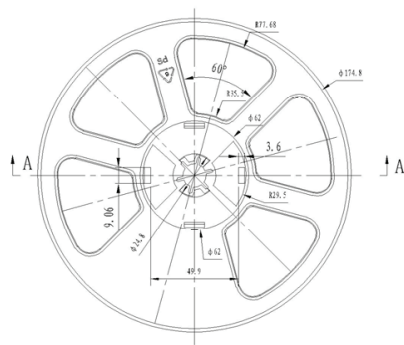

W	A	N	T	E	F	D
16.4±0.3	178±0.5	62±0.4	1.8±0.2	2.0±0.5	21.8±0.8	13.5±0.3

Dimensions: mm

**ATTENTION:** Abracon Corporation's products are COTS – Commercial-Off-The-Shelf products; suitable for Commercial, Industrial and, where designated, Automotive Applications. Abracon's products are not specifically designed for Military, Aviation, Aerospace, Life-dependant Medical applications or any application requiring high reliability where component failure could result in loss of life and/or property. For applications requiring high reliability and/or presenting an extreme operating environment, written consent and authorization from Abracon Corporation is required. Please contact Abracon Corporation for more information.

ABRACON IS  
ISO9001:2008  
CERTIFIED



2 Faraday, Suite# B | Irvine | CA 92618 Revised: 04.02.15

Ph. 949.546.8000 | Fax. 949.546.8001

Visit [www.abracon.com](http://www.abracon.com) for Terms and Conditions of Sale

Компания «Life Electronics» занимается поставками электронных компонентов импортного и отечественного производства от производителей и со складов крупных дистрибьюторов Европы, Америки и Азии.

С конца 2013 года компания активно расширяет линейку поставок компонентов по направлению коаксиальный кабель, кварцевые генераторы и конденсаторы (керамические, пленочные, электролитические), за счёт заключения дистрибьюторских договоров

Мы предлагаем:

- Конкуренспособные цены и скидки постоянным клиентам.
- Специальные условия для постоянных клиентов.
- Подбор аналогов.
- Поставку компонентов в любых объемах, удовлетворяющих вашим потребностям.
- Приемлемые сроки поставки, возможна ускоренная поставка.
- Доставку товара в любую точку России и стран СНГ.
- Комплексную поставку.
- Работу по проектам и поставку образцов.
- Формирование склада под заказчика.
- Сертификаты соответствия на поставляемую продукцию (по желанию клиента).
- Тестирование поставляемой продукции.
- Поставку компонентов, требующих военную и космическую приемку.
- Входной контроль качества.
- Наличие сертификата ISO.

В составе нашей компании организован Конструкторский отдел, призванный помогать разработчикам, и инженерам.

Конструкторский отдел помогает осуществить:

- Регистрацию проекта у производителя компонентов.
- Техническую поддержку проекта.
- Защиту от снятия компонента с производства.
- Оценку стоимости проекта по компонентам.
- Изготовление тестовой платы монтаж и пусконаладочные работы.



Тел: +7 (812) 336 43 04 (многоканальный)

Email: [org@lifeelectronics.ru](mailto:org@lifeelectronics.ru)