

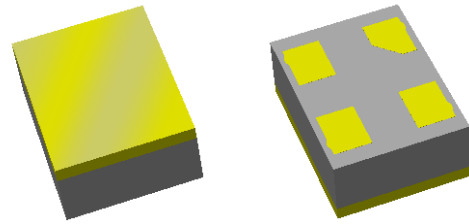

Applications

- ISM band wireless systems
- Smart Metering systems
- Remote meter reading
- Wireless microphones
- Wireless sensing
- Wireless modules
- General purpose wireless systems



CSP-8A, 2.00 x 1.50 x 0.69 mm

Product Features

- Usable bandwidth 26 MHz
- High attenuation
- Low Loss
- Excellent power handling
- Single-ended operation
- No impedance matching required for operation at 50Ω
- Small Size: 2.00 x 1.50 x 0.69 mm
- Ceramic Chip Scale Package (CSP)
- Hermetically sealed
- RoHS compliant, Pb-free 

Functional Block Diagram

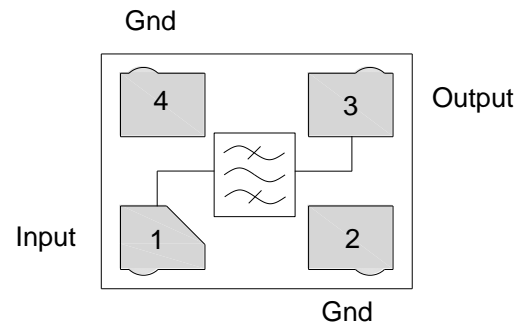

General Description

The 856327 is a bandpass RF SAW filter specifically designed for the North American, Unlicensed, Industrial, Scientific and Medical band at 915 MHz. The filter BW covers the entire available band from 902 to 928 MHz.

The filter's low insertion loss, 50 ohm matched ports and compact footprint simplify system integration.

Pin Configuration - Single Ended

Pin No.	Label
1	Input
3	Output
2,4	Ground

Ordering Information

Part No.	Description
856327	Product description
856327-EVB	Evaluation board description

Standard T/R size = 10,000 units/reel

Absolute Maximum Ratings

Parameter	Rating
Storage Temperature ⁽¹⁾	-40 to +85°C
Operable Temperature ⁽²⁾	-40 to +85°C
RF Input Power ⁽³⁾	+8 dBm

1. Operation of this device outside the parameter ranges given may cause permanent damage.
2. Specifications are not guaranteed over all operable conditions.
3. Input Power with applied CW signal at +55°C for 10K hours

Electrical Specifications ⁽¹⁾

Specified Temperature Range: ⁽²⁾ -40°C to +85°C

Parameter ⁽³⁾	Conditions	Min	Typ ⁽⁴⁾	Max	Units
Center Frequency		-	915	-	MHz
Maximum Insertion Loss	902 – 928 MHz	-	2.3	3.0	dB
Amplitude Ripple	902 – 928 MHz	-	0.35	1.0	dB p-p
Group Delay Variation	902 – 928 MHz	-	15	50	ns p-p
Absolute Attenuation ⁽⁵⁾	10 – 857.5 MHz	40	47	-	dB
	857.5 – 882.5 MHz	35	43	-	dB
	970 – 1005 MHz	35	40	-	dB
	1005 – 1110 MHz	40	50	-	dB
	1110 – 3000 MHz	30	37	-	dB
Input Return Loss	902 – 928 MHz	10	14	-	dB
Output Return Loss	902 – 928 MHz	10	14	-	dB
Source Impedance ⁽⁶⁾	(single-ended)	-	50	-	Ω
Load Impedance ⁽⁶⁾	(single-ended)	-	50	-	Ω

Notes:

1. All specifications are based on the test circuit on page 3
2. In production, devices will be tested at room temperature to a guardbanded specification to ensure electrical compliance over temperature
3. Electrical margin has been built into the design to account for the variations due to temperature drift and manufacturing tolerances
4. Typical values are given at 25 °C
5. Relative to zero dB
6. This is the optimum impedance in order to achieve the performance shown

856327-EVB Evaluation Board

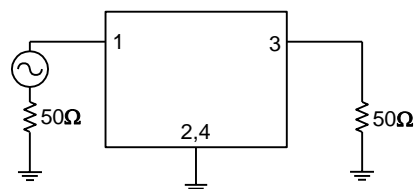
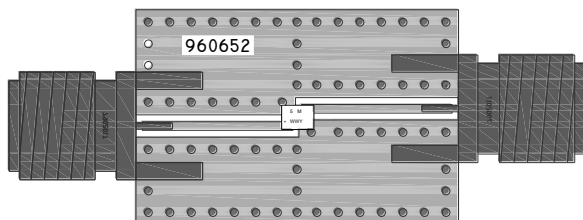

Notes:

1. Impedance matching required.
2. PCB: .500 x .750 x .063; Construction (5 layer stack-up):
 $\frac{1}{2}$ oz Cu Top Layer; Dielectric: *Taconic TLY-5A* (.0075); $\frac{1}{2}$ oz Cu Middle Layer, *FR4*; $\frac{1}{2}$ oz Cu Bottom Layer; total thickness (0.063) (dimensions are in inches).
 Contact TriQuint for Gerber files.

Bill of Material – 856327-EVB

Reference Des.	Value	Description	Manuf.	Part Number
U1	N/A	915 MHz SAW filter	TriQuint	856327
SMA	N/A	SMA connector	Radiall	9602-1111-018
PCB	N/A	3-layer	multiple	960652

PCB Mounting Pattern

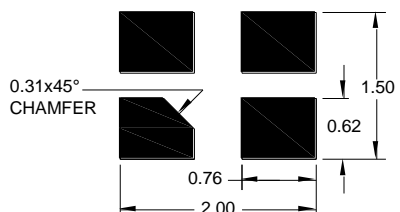

Notes:

1. All dimensions are in millimeters. Angles are in degrees.
2. This drawing specifies the mounting pattern used on the TriQuint evaluation board for this product. Some modification may be necessary to suit end user assembly materials and processes.

Performance Plots - 856327-EVB

Test conditions unless otherwise noted: Temp= +25°C

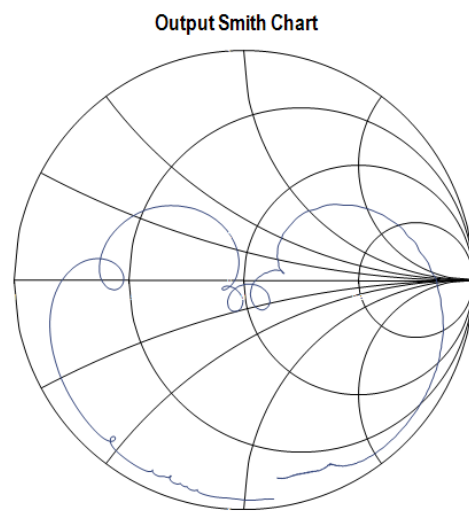
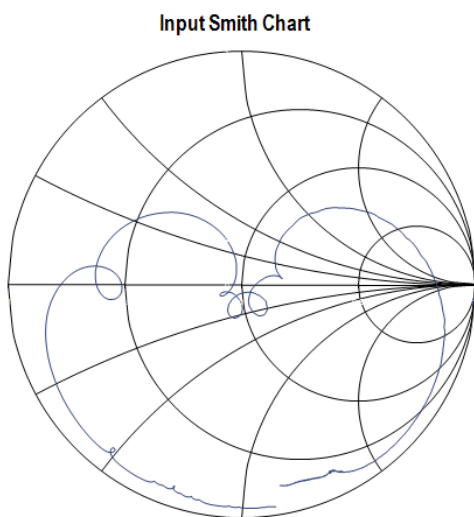
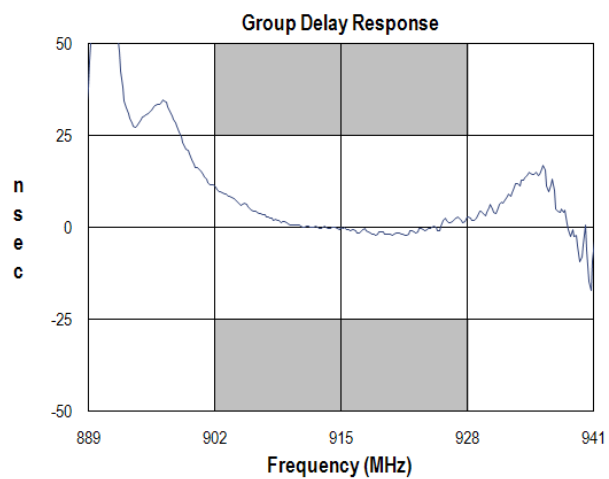
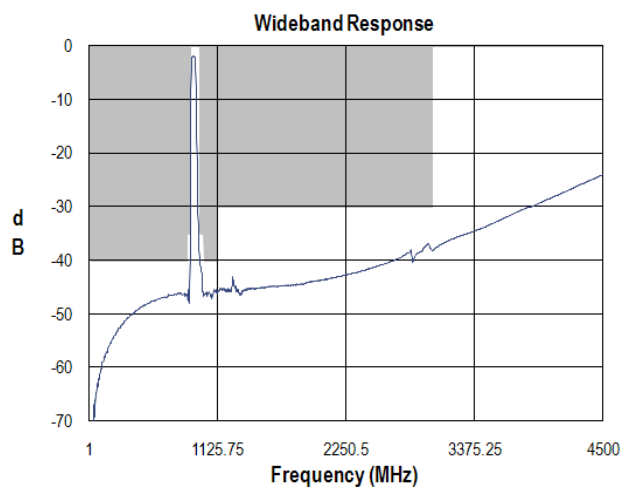
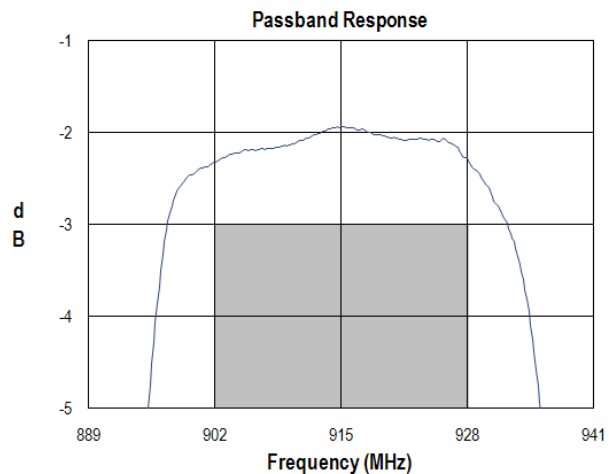
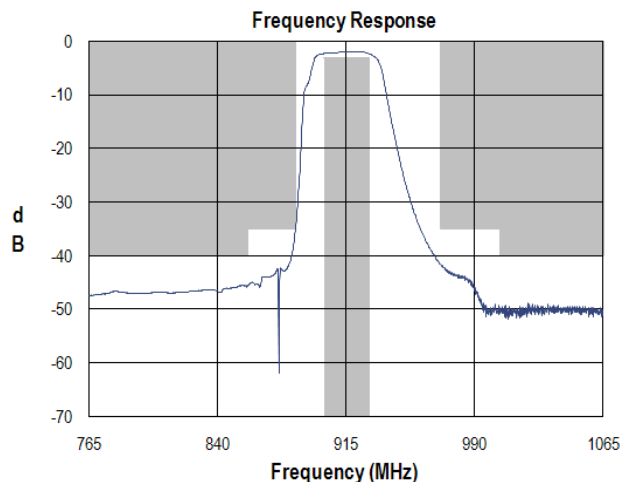

Package Information, Marking and Dimensions

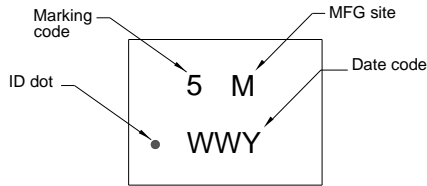

Package Style: CSP-8A
Dimensions: 2.00 x 1.5 x 0.69 mm

Body: Al_2O_3 ceramic
Lid: Kovar or Alloy 42, Au over Ni plated
Terminations: Au plating 0.5 - 1.0 μ m, over a 2 - 6 μ m Ni plating

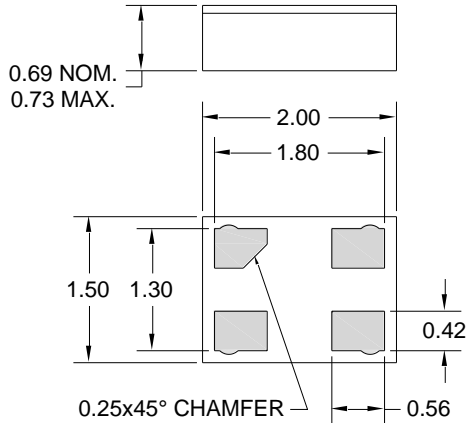

All dimensions shown are nominal in millimeters
All tolerances are ± 0.15 mm except overall length and width ± 0.10 mm

The date code consists of day of the current year (Julian, 3 digits), Y = last digit of the year, and M = manufacturing site code

- Notes:
1. All dimensions shown are typical in millimeters
 2. An asterisk (*) in front of the marking code indicates prototype.

Tape and Reel information

Standard T/R size = 10,000 units/reel

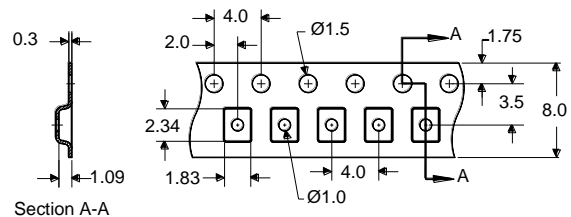
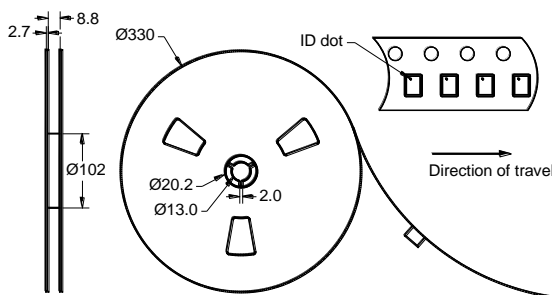

Product Compliance Information

ESD Sensitivity Ratings



Caution! ESD-Sensitive Device

ESD Rating: Class 0B
Value: Passes \leq 200 V
Test: Human Body Model (HBM)
Standard: JEDEC Standard JESD22-A114

ESD Rating: Class A
Value: Passes \leq 150
Test: Machine Model (MM)
Standard: JEDEC Standard JESD22-A115

MSL Rating

Not applicable. Hermetic package.

Solderability

Compatible with both lead-free (260°C maximum reflow temperature) and tin/lead (245°C maximum reflow temperature) soldering processes.

Refer to [Soldering Profile](#) for recommended guidelines.

RoHs Compliance

This part is compliant with EU 2002/95/EC RoHS directive (Restrictions on the Use of Certain Hazardous Substances in Electrical and Electronic Equipment).

This product also has the following attributes:

- Lead Free
- Halogen Free (Chlorine, Bromine)
- Antimony Free
- TBBP-A (C₁₅H₁₂Br₄O₂) Free
- PFOS Free
- SVHC Free

Contact Information

For the latest specifications, additional product information, worldwide sales and distribution locations, and information about TriQuint:

Web: www.triquint.com
Email: info-sales@tqs.com

Tel: +1.407.886.8860
Fax: +1.407.886.7061

For technical questions and application information: **Email:** flapplication.engineering@tqs.com

Important Notice

The information contained herein is believed to be reliable. TriQuint makes no warranties regarding the information contained herein. TriQuint assumes no responsibility or liability whatsoever for any of the information contained herein. TriQuint assumes no responsibility or liability whatsoever for the use of the information contained herein. The information contained herein is provided "AS IS, WHERE IS" and with all faults, and the entire risk associated with such information is entirely with the user. All information contained herein is subject to change without notice. Customers should obtain and verify the latest relevant information before placing orders for TriQuint products. The information contained herein or any use of such information does not grant, explicitly or implicitly, to any party any patent rights, licenses, or any other intellectual property rights, whether with regard to such information itself or anything described by such information.

TriQuint products are not warranted or authorized for use as critical components in medical, life-saving, or life-sustaining applications, or other applications where a failure would reasonably be expected to cause severe personal injury or death.

Компания «Life Electronics» занимается поставками электронных компонентов импортного и отечественного производства от производителей и со складов крупных дистрибьюторов Европы, Америки и Азии.

С конца 2013 года компания активно расширяет линейку поставок компонентов по направлению коаксиальный кабель, кварцевые генераторы и конденсаторы (керамические, пленочные, электролитические), за счёт заключения дистрибьюторских договоров

Мы предлагаем:

- Конкурентоспособные цены и скидки постоянным клиентам.
- Специальные условия для постоянных клиентов.
- Подбор аналогов.
- Поставку компонентов в любых объемах, удовлетворяющих вашим потребностям.
- Приемлемые сроки поставки, возможна ускоренная поставка.
- Доставку товара в любую точку России и стран СНГ.
- Комплексную поставку.
- Работу по проектам и поставку образцов.
- Формирование склада под заказчика.
- Сертификаты соответствия на поставляемую продукцию (по желанию клиента).
- Тестирование поставляемой продукции.
- Поставку компонентов, требующих военную и космическую приемку.
- Входной контроль качества.
- Наличие сертификата ISO.

В составе нашей компании организован Конструкторский отдел, призванный помогать разработчикам, и инженерам.

Конструкторский отдел помогает осуществить:

- Регистрацию проекта у производителя компонентов.
- Техническую поддержку проекта.
- Защиту от снятия компонента с производства.
- Оценку стоимости проекта по компонентам.
- Изготовление тестовой платы монтаж и пусконаладочные работы.



Тел: +7 (812) 336 43 04 (многоканальный)
Email: org@lifeelectronics.ru