



BGA6130

400 MHz to 2700 MHz 1 W high efficiency silicon amplifier

Rev. 2 — 12 February 2014

Product data sheet

1. General description

The MMIC is a one-stage amplifier, offered in a low-cost leadless surface-mount package. At 3.6 V it delivers 29.5 dBm output power at 3 dB gain compression with efficiency higher than 55 %. Its power saving features include simple quiescent current adjustment, which allows class-AB operation and logic-level shutdown control to reduce the supply current to 4 μ A.

2. Features and benefits

- 400 MHz to 2700 MHz frequency operating range
- Integrated active biasing
- External matching allows broad application optimization of the electrical performance
- Efficiencies higher than 55 %
- 3.6 V single supply operation
- Power-down
- Excellent robustness:
 - ◆ All pins ESD protected (HBM 6 kV; CDM 2 kV)
 - ◆ Withstands mismatch of VSWR 50 : 1 through all phases
 - ◆ Withstands electrical over-stress peaks of 4.5 V on the supply voltage

3. Applications

In this data sheet two Industrial, Scientific and Medical (ISM) applications are described, namely ISM at 434 MHz and ISM at 915 MHz. The BGA6130 is also suited for a range of other applications:

- Broadband CPE / MoCA
- WLAN / ISM / RFID
- Wireless Sensor Network (WSN)
- Industrial applications
- Satellite Master Antenna TV (SMATV)



4. Quick reference data

Table 1. Quick reference data

$3.3\text{ V} \leq V_{\text{SUP}} \leq 3.9\text{ V}$; $-40\text{ }^{\circ}\text{C} \leq T_{\text{case}} \leq +85\text{ }^{\circ}\text{C}$; $P_i < -20\text{ dBm}$; $R_3 = 3900\ \Omega$ (tolerance 10 %); input and output impedances matched to $50\ \Omega$ (see [Section 14](#)); pin ENABLE = HIGH; unless otherwise specified.

Symbol	Parameter	Conditions	Min	Typ	Max	Unit
V_{SUP}	supply voltage		[1] 3.3	3.6	3.9	V
$I_{\text{CC(tot)}}$	total supply current		[2] 50	70	90	mA
		$1\text{ k}\Omega \leq R_3 \leq 5\text{ k}\Omega$	[2] 30	-	250	mA
		$1\text{ k}\Omega \leq R_3 \leq 5\text{ k}\Omega$; pin ENABLE = LOW	[2] -	4	6	μA
T_{case}	case temperature		[3] -40	+25	+85	$^{\circ}\text{C}$
f	frequency		400	-	2700	MHz

Measured at ISM-434 MHz (see [Section 14](#))

f	frequency		433	434	435	MHz
G_p	power gain	$433\text{ MHz} \leq f \leq 435\text{ MHz}$	14	17	20	dB
$P_{\text{L}(1\text{dB})}$	output power at 1 dB gain compression	$433\text{ MHz} \leq f \leq 435\text{ MHz}$	25	28	-	dBm
$P_{\text{L}(3\text{dB})}$	output power at 3 dB gain compression	$433\text{ MHz} \leq f \leq 435\text{ MHz}$	-	29.5	-	dBm
η	efficiency	$433\text{ MHz} \leq f \leq 435\text{ MHz}$; at $P_{\text{L}(3\text{dB})}$	-	56	-	%

Measured at ISM-915 MHz (see [Section 14](#))

f	frequency		902	915	928	MHz
G_p	power gain	$902\text{ MHz} \leq f \leq 928\text{ MHz}$	11	14	17	dB
$P_{\text{L}(1\text{dB})}$	output power at 1 dB gain compression	$902\text{ MHz} \leq f \leq 928\text{ MHz}$	26	29	-	dBm
$P_{\text{L}(3\text{dB})}$	output power at 3 dB gain compression	$902\text{ MHz} \leq f \leq 928\text{ MHz}$	-	30	-	dBm
η	efficiency	$902\text{ MHz} \leq f \leq 928\text{ MHz}$; at $P_{\text{L}(3\text{dB})}$	-	60	-	%

[1] Supply voltage on pins RF_OUT and V_{CC} .

[2] Current through pins RF_OUT and V_{CC} .

[3] T_{case} is the temperature at the soldering point of the exposed die pad.

5. Design support

Table 2. Available design support

Download from the BGA6130 product page on <http://www.nxp.com>.

Support item	Available	Remarks
Device models for Agilent EEsof EDA ADS	planned	[1] Based on Mextram device model.
Device models for AWR Microwave Office	no	[1] Based on Mextram device model.
Device models for ANSYS Ansoft designer	no	[1] Based on Mextram device model.
SPICE model	planned	[1] Based on Gummel-Poon device model.
S-parameters	yes	
Noise parameters	yes	
Customer evaluation kit	yes	See Section 6 and Section 14 .
Gerber files	yes	Gerber files of boards provided with the customer evaluation kit.
Solder pattern	yes	

[1] See <http://www.nxp.com/models.html>.

6. Ordering information

Table 3. Ordering information

Type number	Package		Version
	Name	Description	
BGA6130	HVSON8	plastic thermal enhanced very thin small outline package; no leads; 8 terminals; body 3 × 3 × 0.85 mm	SOT908-3
OM7828/BGA6130/KIT	-	Customer evaluation kit for BGA6130 [1]	-

- [1] The customer evaluation kit contains the following:
- a) Fully populated and matched RF evaluation board for ISM 434
 - b) Fully populated and matched RF evaluation board for ISM 915
 - c) Unpopulated Printed-Circuit Board (PCB)
 - d) Two SMA connectors for fitting unpopulated Printed-Circuit Board (PCB)
 - e) BGA6130 samples

7. Functional diagram

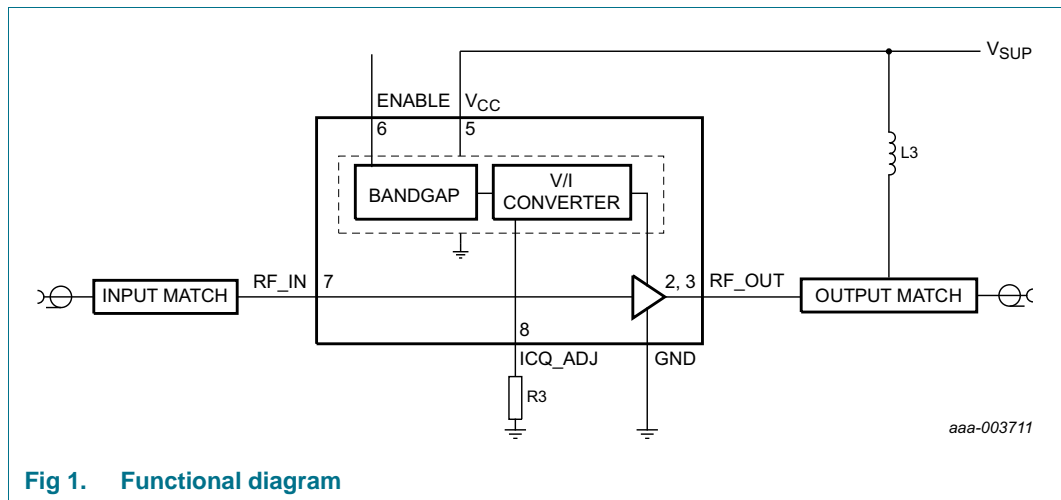
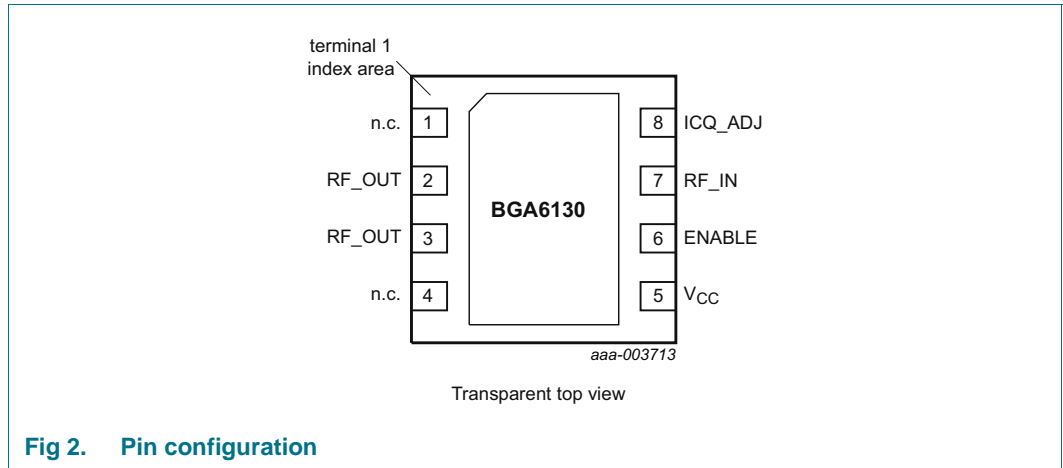

Fig 1. Functional diagram

8. Pinning information

8.1 Pinning



8.2 Pin description

Table 4. Pin description

Symbol	Pin	Description
n.c.	1, 4	not connected [1]
RF_OUT	2, 3	RF output and supply to the amplifier [2]
V _{CC}	5	bias supply voltage [3]
ENABLE	6	enable
RF_IN	7	RF input [2]
ICQ_ADJ	8	quiescent collector current adjustment by an external resistor
GND	exposed die pad	ground [4]

[1] This pin can be connected to ground.

[2] This pin requires an external DC-blocking capacitor.

[3] RF decoupled.

[4] The exposed die pad of the SOT908-3 also functions as heatsink for the power amplifier.

9. Functional description

9.1 Supply current adjustment

The supply current can be adjusted by changing the value of biasing resistor R3 which connects pin ICQ_ADJ (pin 8) to ground (see [Figure 1](#)).

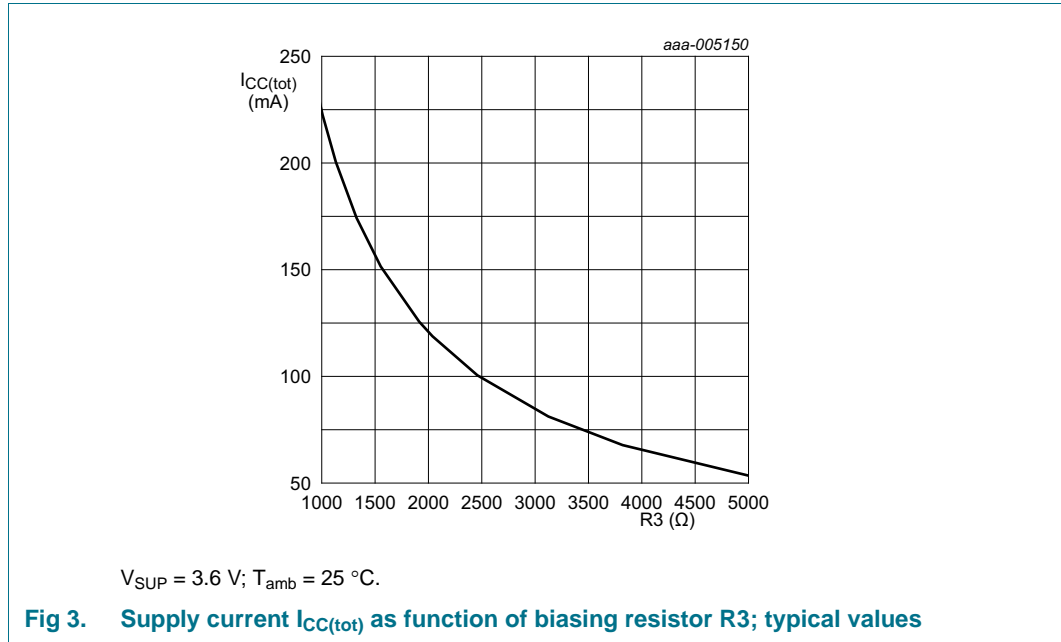

9.2 Enable control

The BGA6130 can be powered down using enable pin 6 (ENABLE). In case this control function is not needed the enable pin can be connected to the bias supply voltage pin 5 (V_{CC}). The current through the enable pin 6 should never exceed 20 mA as this might damage the ESD protection circuitry. This can be avoided either by preventing the voltage on this pin to exceed the supply voltage (V_{SUP}) or by adding a series resistor.

Table 5. Enable truth table

See [Table 8](#).

Logic level on pin ENABLE (pin 6)	Status BGA6130
LOW	powered down
HIGH	powered on

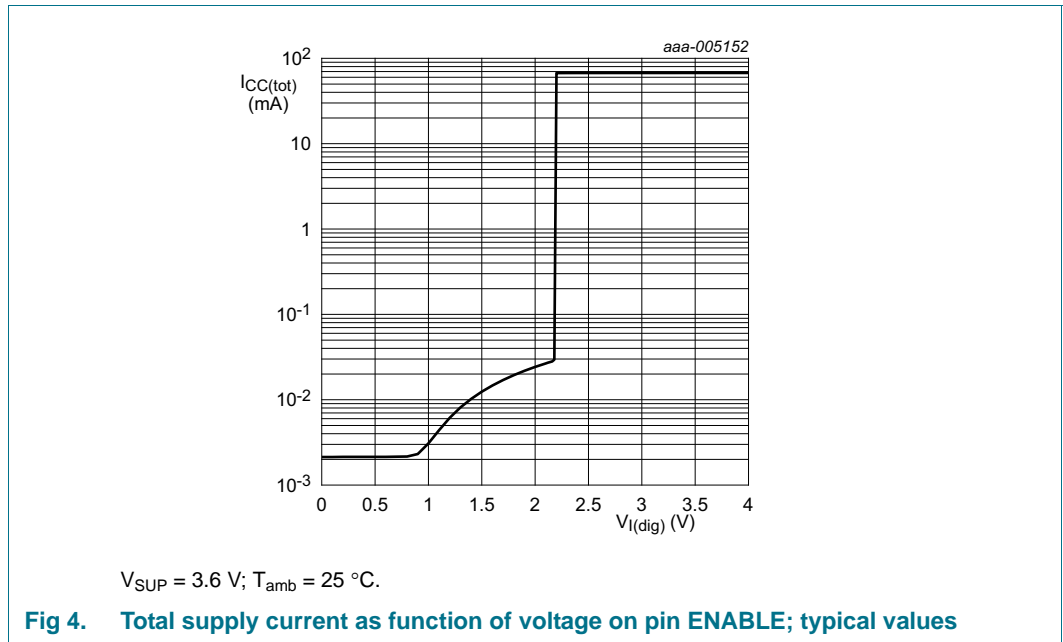

10. Limiting values

Table 6. Limiting values

In accordance with the Absolute Maximum Rating System (IEC 60134).

Symbol	Parameter	Conditions	Min	Max	Unit
V_{SUP}	supply voltage		[1] -0.2	+4.5	V
$V_{I(dig)}$	digital input voltage		[2][4] 0	$V_{SUP} + 0.3$	V
$I_{I(dig)}$	digital input current		[3][4] -20	+20	mA
$I_{CC(tot)}$	total supply current		-	350	mA
$P_{i(RF)}$	RF input power	$f = 434\text{ MHz};$ switched	-	15	dBm
		$f = 915\text{ MHz};$ switched	-	15	dBm
T_{stg}	storage temperature		-65	+150	$^{\circ}\text{C}$
T_j	junction temperature		-	150	$^{\circ}\text{C}$
V_{ESD}	electrostatic discharge voltage	Human Body Model (HBM); According JEDEC standard 22-A114E	-	6	kV
		Charged Device Model (CDM); According JEDEC standard 22-C101B	-	2	kV

- [1] Absolute maximum DC voltage on pins RF_OUT, ICQ_ADJ and V_{CC} .
- [2] Absolute maximum DC voltage on pin ENABLE.
- [3] Absolute maximum DC current through pin ENABLE.
- [4] If $V_{I(dig)}$ exceeds V_{SUP} the internal ESD protection circuit can be damaged (see [Figure 5](#)). The pin ENABLE can be connected to V_{CC} in case the enable control function is not used (see [Section 9.2](#)).

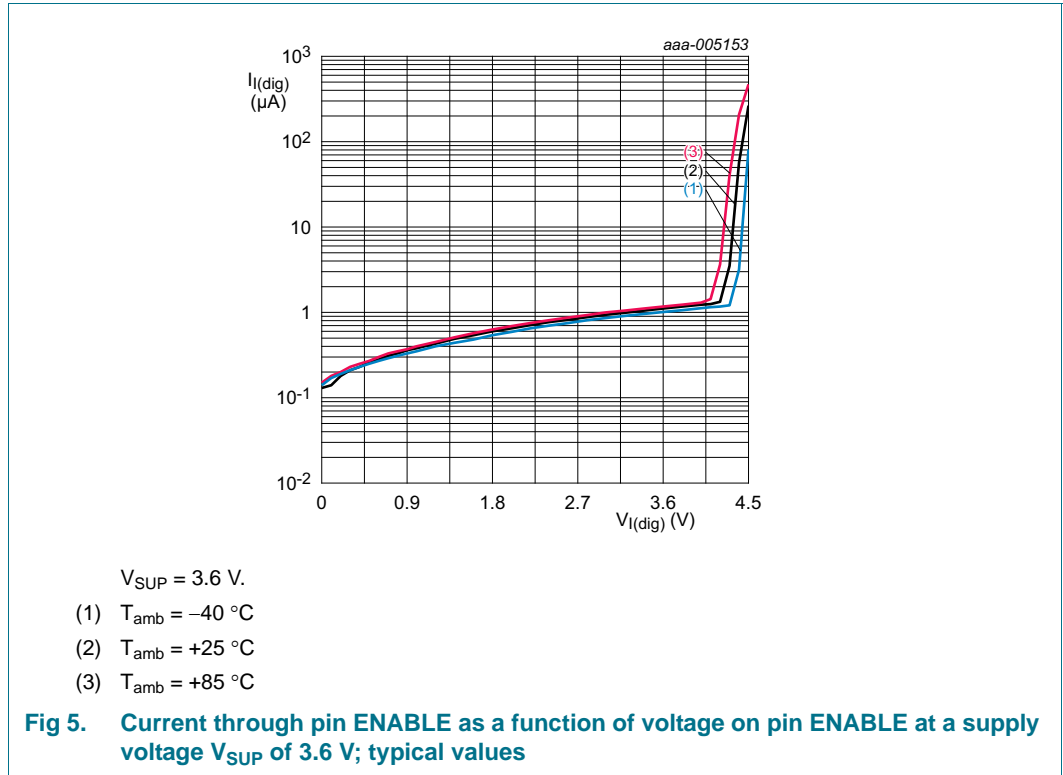

11. Thermal characteristics

Table 7. Thermal characteristics

Symbol	Parameter	Conditions	Typ	Unit
$R_{th(j-case)}$	thermal resistance from junction to case	$T_{case} < 85\text{ }^{\circ}C$	6	K/W

12. Static characteristics

Table 8. Static characteristics

$3.3 V \leq V_{SUP} \leq 3.9 V$; $-40\text{ }^{\circ}C \leq T_{case} \leq +85\text{ }^{\circ}C$; $P_i < -20\text{ dBm}$; $R_3 = 3900\ \Omega$ (tolerance 10 %); input and output impedances matched to $50\ \Omega$ (see [Section 14](#)); pin ENABLE = HIGH; unless otherwise specified.

Symbol	Parameter	Conditions	Min	Typ	Max	Unit
V_{SUP}	supply voltage		[1] 3.3	3.6	3.9	V
$I_{CC(tot)}$	total supply current		[2] 55	70	85	mA
		$1\text{ k}\Omega \leq R_3 \leq 5\text{ k}\Omega$	[2] 30	-	250	mA
		$1\text{ k}\Omega \leq R_3 \leq 5\text{ k}\Omega$; pin ENABLE = LOW	[2] -	4	6	μA
T_{case}	case temperature		[3] -40	+25	+85	$^{\circ}C$

Table 8. Static characteristics ...continued

$3.3\text{ V} \leq V_{SUP} \leq 3.9\text{ V}$; $-40\text{ }^{\circ}\text{C} \leq T_{case} \leq +85\text{ }^{\circ}\text{C}$; $P_i < -20\text{ dBm}$; $R_3 = 3900\ \Omega$ (tolerance 10 %); input and output impedances matched to $50\ \Omega$ (see [Section 14](#)); pin ENABLE = HIGH; unless otherwise specified.

Symbol	Parameter	Conditions	Min	Typ	Max	Unit
I_{CC}	supply current	on pin RF_OUT	-	63	-	mA
		on pin V_{CC}	-	7	-	mA
		on pin ENABLE	-	-	3	μA
V_{IL}	LOW-level input voltage	[4]	0	-	0.7	V
V_{IH}	HIGH-level input voltage	[4]	2.5	-	V_{SUP}	V

[1] Supply voltage on pins RF_OUT and V_{CC} .

[2] Current through pins RF_OUT and V_{CC} .

[3] T_{case} is the temperature at the soldering point of the exposed die pad.

[4] On digital input pin ENABLE.

13. Dynamic characteristics

Table 9. Dynamic characteristics

$3.3\text{ V} \leq V_{SUP} \leq 3.9\text{ V}$; $-40\text{ }^{\circ}\text{C} \leq T_{case} \leq +85\text{ }^{\circ}\text{C}$; $P_i < -20\text{ dBm}$; $R_3 = 3900\ \Omega$ (tolerance 10 %); input and output impedances matched to $50\ \Omega$ (see [Section 14](#)); pin ENABLE = HIGH; unless otherwise specified.

Symbol	Parameter	Conditions	Min	Typ	Max	Unit
f	frequency		400	-	2700	MHz
Measured at ISM-434 MHz (see Section 14)						
f	frequency		433	434	435	MHz
G_p	power gain	$433\text{ MHz} \leq f \leq 435\text{ MHz}$	14	17	20	dB
		$433\text{ MHz} \leq f \leq 435\text{ MHz}$; pin ENABLE = LOW	-	-17	-	dB
$P_{L(1dB)}$	output power at 1 dB gain compression	$433\text{ MHz} \leq f \leq 435\text{ MHz}$	25	28	-	dBm
$P_{L(3dB)}$	output power at 3 dB gain compression	$433\text{ MHz} \leq f \leq 435\text{ MHz}$	-	29.5	-	dBm
IMD3	third-order intermodulation distortion	$433\text{ MHz} \leq f \leq 435\text{ MHz}$; $P_L = 15\text{ dBm}$ per tone; tone spacing = 1 MHz	-	-34	-	dBc
NF	noise figure	$433\text{ MHz} \leq f \leq 435\text{ MHz}$	-	4.5	-	dB
RL_{in}	input return loss	$433\text{ MHz} \leq f \leq 435\text{ MHz}$	8	10	-	dB
		$433\text{ MHz} \leq f \leq 435\text{ MHz}$; pin ENABLE = LOW	-	4.5	-	dB
RL_{out}	output return loss	$433\text{ MHz} \leq f \leq 435\text{ MHz}$	6	8	-	dB
		$433\text{ MHz} \leq f \leq 435\text{ MHz}$; pin ENABLE = LOW	-	0.5	-	dB
ISL	isolation	$433\text{ MHz} \leq f \leq 435\text{ MHz}$	-	28	-	dB
		$433\text{ MHz} \leq f \leq 435\text{ MHz}$; pin ENABLE = LOW	-	-17	-	dB
η	efficiency	$433\text{ MHz} \leq f \leq 435\text{ MHz}$; at $P_{L(3dB)}$	-	56	-	%
$t_{d(pu)}$	power-up delay time	after pin ENABLE is switched to logic HIGH; to within 0.1 dB of final gain state.	-	2.2	-	μs
$t_{d(pd)}$	power-down delay time	after pin ENABLE is switched to logic LOW; to within 0.1 dB of final gain state.	-	0.5	-	μs

Table 9. Dynamic characteristics ...continued

$3.3\text{ V} \leq V_{SUP} \leq 3.9\text{ V}$; $-40\text{ }^{\circ}\text{C} \leq T_{case} \leq +85\text{ }^{\circ}\text{C}$; $P_i < -20\text{ dBm}$; $R_3 = 3900\ \Omega$ (tolerance 10 %); input and output impedances matched to $50\ \Omega$ (see [Section 14](#)); pin ENABLE = HIGH; unless otherwise specified.

Symbol	Parameter	Conditions	Min	Typ	Max	Unit
Measured at ISM-915 MHz (see Section 14)						
f	frequency		902	915	928	MHz
G _p	power gain	902 MHz ≤ f ≤ 928 MHz	11	14	17	dB
		902 MHz ≤ f ≤ 928 MHz; pin ENABLE = LOW	-	-16.5	-	dB
P _{L(1dB)}	output power at 1 dB gain compression	902 MHz ≤ f ≤ 928 MHz	26	29	-	dBm
P _{L(3dB)}	output power at 3 dB gain compression	902 MHz ≤ f ≤ 928 MHz	-	30	-	dBm
IMD3	third-order intermodulation distortion	902 MHz ≤ f ≤ 928 MHz; P _L = 15 dBm per tone; tone spacing = 1 MHz	-	-34	-	dBc
NF	noise figure	902 MHz ≤ f ≤ 928 MHz	-	4	-	dB
RL _{in}	input return loss	902 MHz ≤ f ≤ 928 MHz	8	10	-	dB
		902 MHz ≤ f ≤ 928 MHz; pin ENABLE = LOW	-	2.5	-	dB
RL _{out}	output return loss	902 MHz ≤ f ≤ 928 MHz	6	8	-	dB
		902 MHz ≤ f ≤ 928 MHz; pin ENABLE = LOW	-	0.5	-	dB
ISL	isolation	902 MHz ≤ f ≤ 928 MHz	-	28	-	dB
		902 MHz ≤ f ≤ 928 MHz; pin ENABLE = LOW	-	-16.5	-	dB
η	efficiency	902 MHz ≤ f ≤ 928 MHz; at P _{L(3dB)}	-	60	-	%
t _{d(pu)}	power-up delay time	after pin ENABLE is switched to logic HIGH; to within 0.1 dB of final gain state.	-	2.5	-	μs
t _{d(pd)}	power-down delay time	after pin ENABLE is switched to logic LOW; to within 0.1 dB of final gain state.	-	0.5	-	μs

14. Application information

The BGA6130 can be used for a wide variety of applications. This section describes two example applications in the Industrial, Scientific and Medical (ISM) frequency bands at 434 MHz and at 915 MHz. The ISM-434 band is used in region 1, Europe, Africa, the Middle East west of the Persian Gulf including Iraq, the former Soviet Union and Mongolia, whereas the ISM-915 band is used in region 2, Americas, Greenland and some of the eastern Pacific Islands. Example ISM applications are Wireless Sensor Networks (WSN), ZigBee and WLAN.

14.1 Application board

Customer evaluation boards are available from NXP (see [Section 6 "Ordering information"](#)). The BGA6130 shall be decoupled and matched as depicted in [Figure 6](#). The ground leads and exposed paddle should be connected directly to the ground plane. Enough via holes should be provided to connect top and bottom ground planes in the final application board. Sufficient cooling should be provided preventing the temperature of the exposed die pad from exceeding 85 °C.

The ISM-434 and ISM-915 application boards have the same input and output matching topology, but differ in component values. Resistor R3 is used to set the bias current. Note resistor R2 which can be used to limit the current through the ESD protection circuit in

case the voltage on pin ENABLE exceeds the supply voltage on pin V_{CC}. L3, C8, C9 and C10 are used to feed a DC current to the RF transistor. The other passive components are used for input and an output matching.

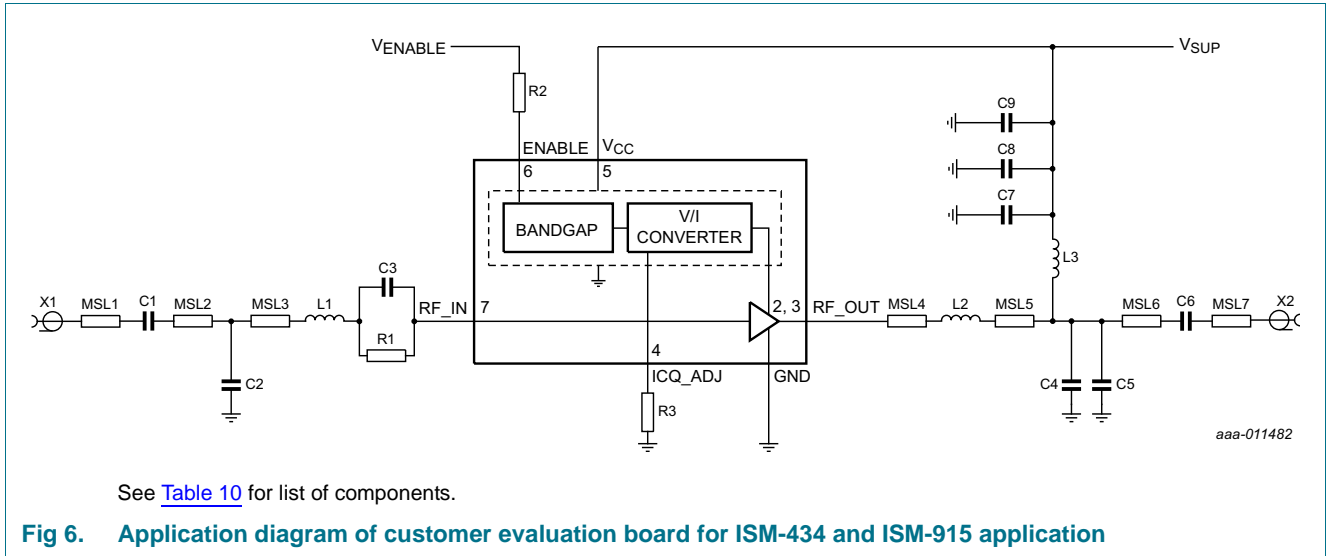

The Printed-Circuit Board (PCB) is a four metal layer substrate board as described in [Figure 7](#). The width and the gap between the strip-line and ground plane are configured such that a 50 ohm transmission line is obtained.

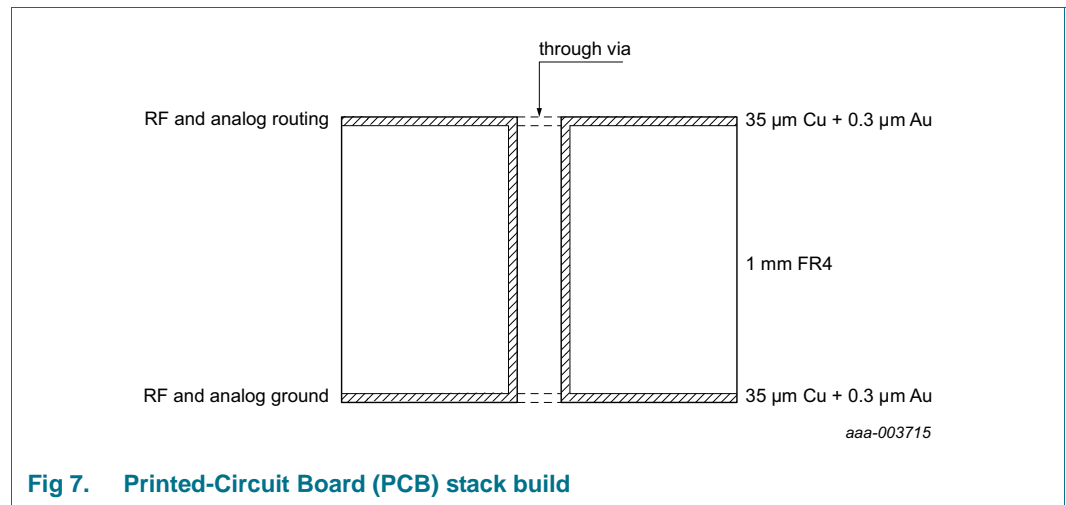

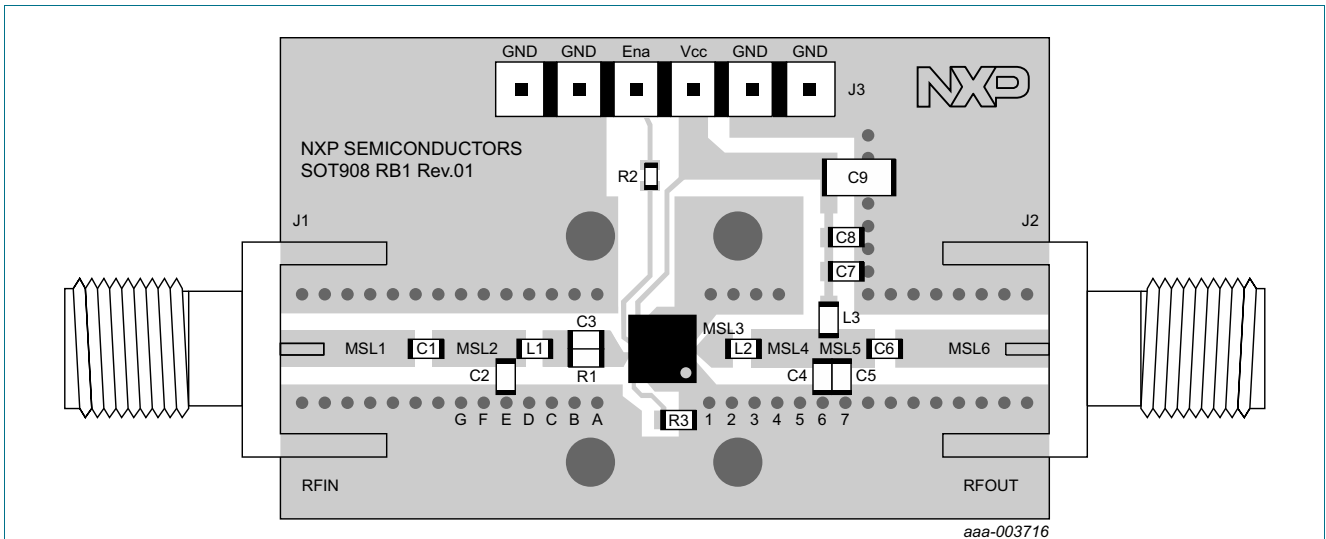

Fig 8. Top view of populated ISM-434 Printed-Circuit Board (PCB)

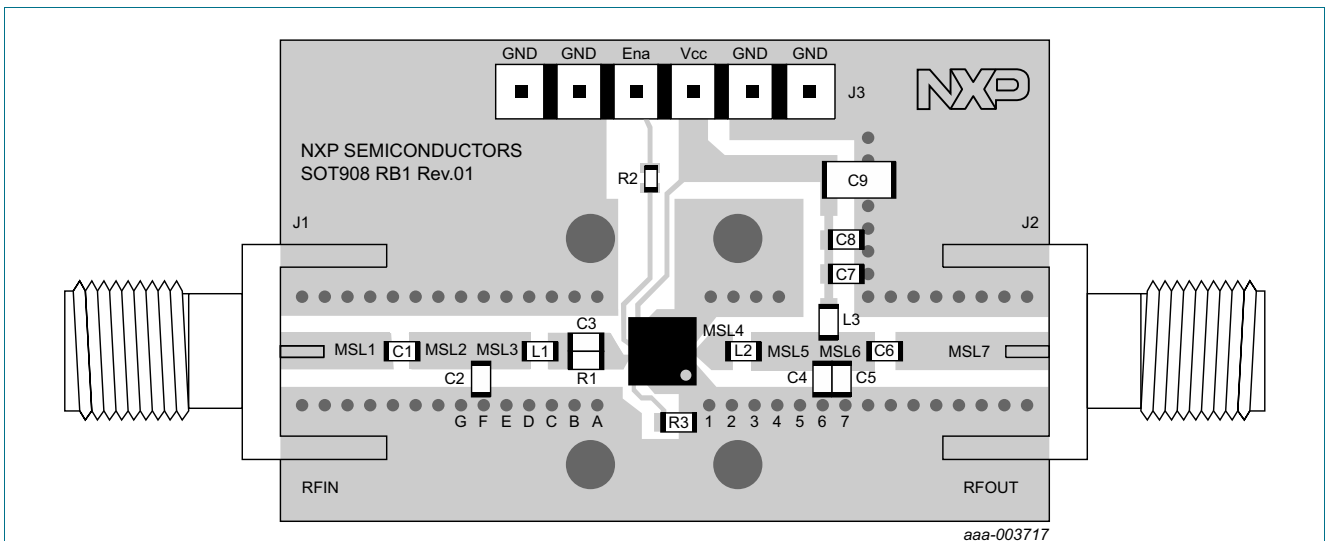

Fig 9. Top view of populated ISM-915 Printed-Circuit Board (PCB)

Table 10. List of componentsSee [Figure 6](#) for schematics.

Component	Description	Value		Remarks
		ISM-434	ISM-915	
C1	capacitor	1 nF	1 nF	Murata GRM series
C2	capacitor	15 pF	10 pF	Murata GRM series
C3	capacitor	15 pF	12 pF	Murata GRM series
C4	capacitor	2 pF	2.7 pF	Murata GRM series
C5	capacitor	15 pF	5.6 pF	Murata GRM series
C6	capacitor	1 nF	1 nF	Murata GRM series
C7	capacitor	1 nF	1 nF	Murata GRM series
C8	capacitor	100 nF	100 nF	Murata GRM series
C9	capacitor	10 μ F	10 μ F	Murata GRM series
IC1	BGA6130	-	-	NXP
MSL1	micro stripline	5.9 mm	5.9 mm	[1]
MSL2	micro stripline	3.1 mm	1.8 mm	[1]
MSL3	micro stripline	-	1.7 mm	[1]
MSL4	micro stripline	1.7 mm	1.8 mm	[1]
MSL5	micro stripline	3.1 mm	3.2 mm	[1]
MSL6	micro stripline	1.7 mm	1.5 mm	[1]
MSL7	micro stripline	6.8 mm	6.8 mm	[1]
R1	resistor	220 Ω	220 Ω	
R2	resistor	270 Ω	270 Ω	
R3	resistor	3900 Ω	3900 Ω	
L1	inductor	15 nH	1.5 nH	Murata LQW series
L2	inductor	5.6 nH	1.5 nH	Murata LQW series
L3	RF choke	68 nH	27 nH	Murata LQW series
X1, X2	SMA connector	-	-	

[1] Length (L) is specified, width (W) = 1.6 mm and spacing (S) = 0.8 mm.

14.2 Characteristics ISM-434

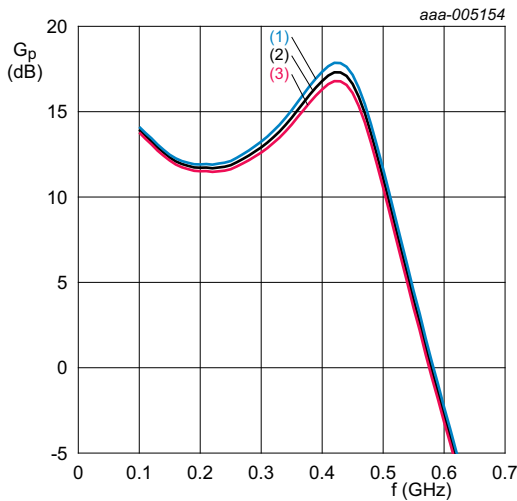

$V_{SUP} = 3.6\text{ V}; I_{CC(tot)} = 70\text{ mA};$ matched for ISM-434.
 (1) $T_{amb} = -40\text{ }^{\circ}\text{C}$
 (2) $T_{amb} = +25\text{ }^{\circ}\text{C}$
 (3) $T_{amb} = +85\text{ }^{\circ}\text{C}$

Fig 10. Power gain as a function of frequency for ISM-434 application; typical values

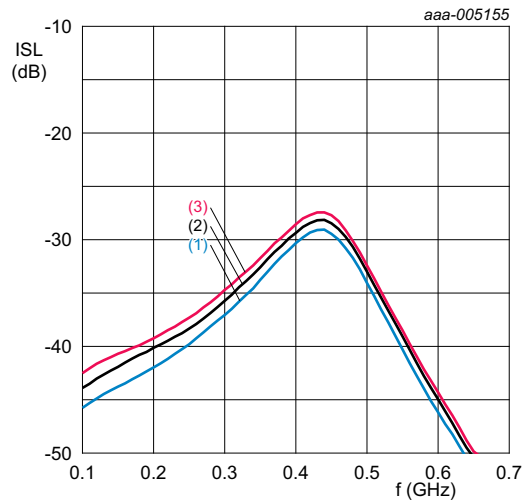

$V_{SUP} = 3.6\text{ V}; I_{CC(tot)} = 70\text{ mA};$ matched for ISM-434.
 (1) $T_{amb} = -40\text{ }^{\circ}\text{C}$
 (2) $T_{amb} = +25\text{ }^{\circ}\text{C}$
 (3) $T_{amb} = +85\text{ }^{\circ}\text{C}$

Fig 11. Isolation as a function of frequency for ISM-434 application; typical values

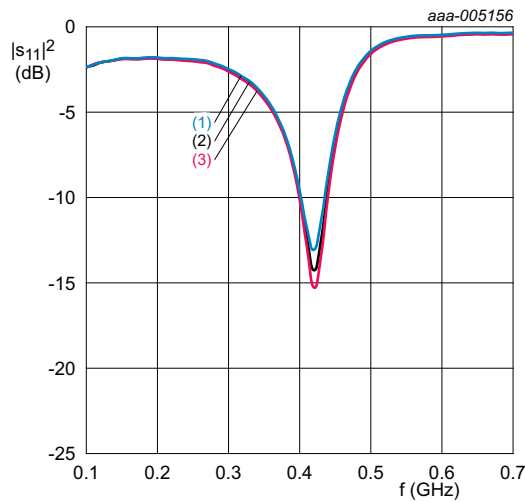

$V_{SUP} = 3.6\text{ V}; I_{CC(tot)} = 70\text{ mA};$ matched for ISM-434.
 (1) $T_{amb} = -40\text{ }^{\circ}\text{C}$
 (2) $T_{amb} = +25\text{ }^{\circ}\text{C}$
 (3) $T_{amb} = +85\text{ }^{\circ}\text{C}$

Fig 12. Input return loss as a function of frequency for ISM-434 application; typical values

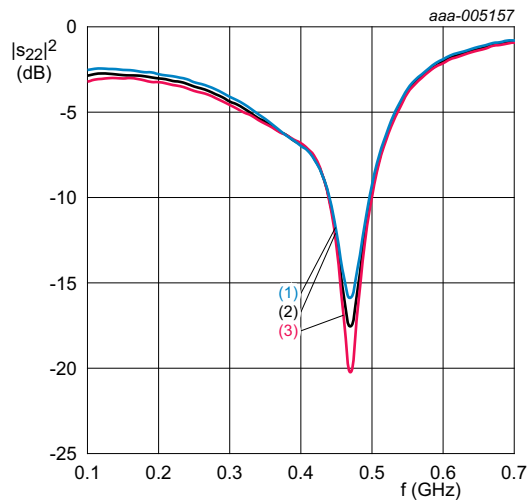

$V_{SUP} = 3.6\text{ V}; I_{CC(tot)} = 70\text{ mA};$ matched for ISM-434.
 (1) $T_{amb} = -40\text{ }^{\circ}\text{C}$
 (2) $T_{amb} = +25\text{ }^{\circ}\text{C}$
 (3) $T_{amb} = +85\text{ }^{\circ}\text{C}$

Fig 13. Output return loss as a function of frequency for ISM-434 application; typical values

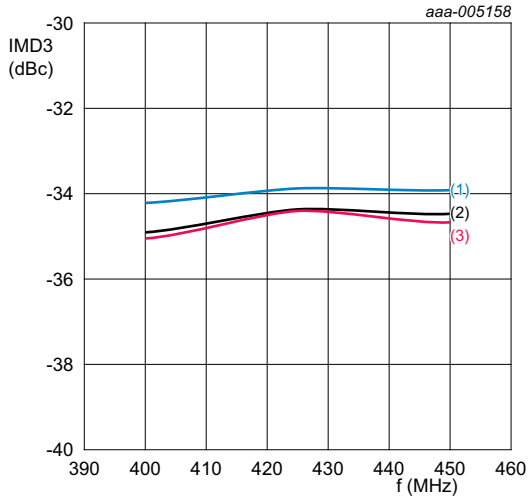

$V_{SUP} = 3.6\text{ V}$; $I_{CC(tot)} = 70\text{ mA}$; $P_L = 15\text{ dBm}$ per tone;
 $\Delta f = 1\text{ MHz}$; matched for ISM-434.

- (1) $T_{amb} = -40\text{ }^\circ\text{C}$
- (2) $T_{amb} = +25\text{ }^\circ\text{C}$
- (3) $T_{amb} = +85\text{ }^\circ\text{C}$

Fig 14. Third order intermodulation distortion as a function of frequency for ISM-434 application; different temperatures; typical values

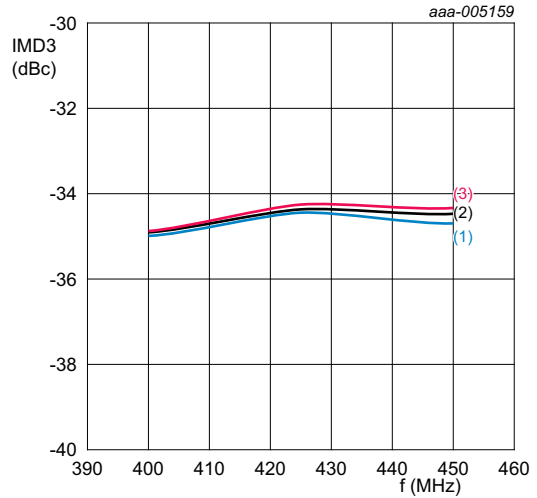

$T_{amb} = 25\text{ }^\circ\text{C}$; $I_{CC(tot)} = 70\text{ mA}$; $P_L = 15\text{ dBm}$ per tone;
 $\Delta f = 1\text{ MHz}$; matched for ISM-434.

- (1) $V_{SUP} = 3.3\text{ V}$
- (2) $V_{SUP} = 3.6\text{ V}$
- (3) $V_{SUP} = 3.9\text{ V}$

Fig 15. Third order intermodulation distortion as a function of frequency for ISM-434 application; different supply voltages; typical values

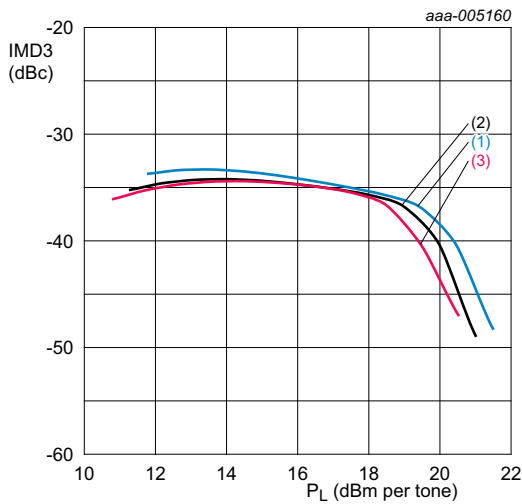

$V_{SUP} = 3.6\text{ V}$; $I_{CC(tot)} = 70\text{ mA}$; $\Delta f = 1\text{ MHz}$; matched for ISM-434.

- (1) $T_{amb} = -40\text{ }^\circ\text{C}$
- (2) $T_{amb} = +25\text{ }^\circ\text{C}$
- (3) $T_{amb} = +85\text{ }^\circ\text{C}$

Fig 16. Third order intermodulation distortion as a function of output power for ISM-434 application; different temperatures; typical values

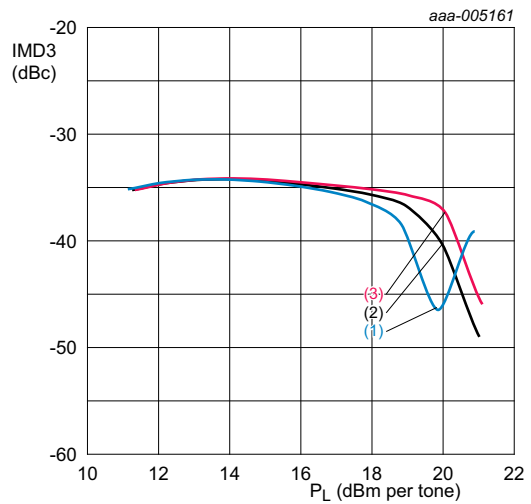

$T_{amb} = 25\text{ }^\circ\text{C}$; $I_{CC(tot)} = 70\text{ mA}$; $\Delta f = 1\text{ MHz}$; matched for ISM-434.

- (1) $V_{SUP} = 3.3\text{ V}$
- (2) $V_{SUP} = 3.6\text{ V}$
- (3) $V_{SUP} = 3.9\text{ V}$

Fig 17. Third order intermodulation distortion as a function of output power for ISM-434 application; different supply voltages; typical values

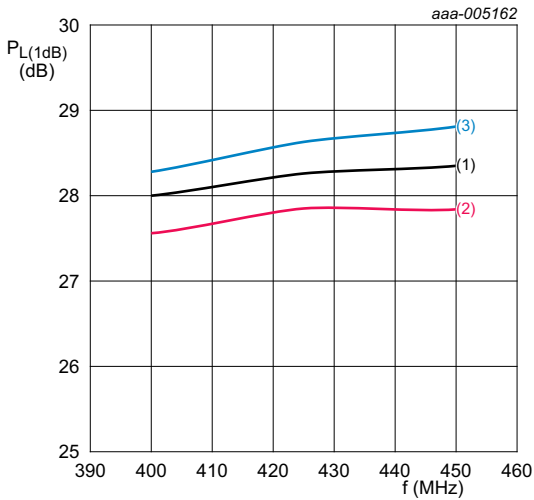

$V_{SUP} = 3.6\text{ V}$; $I_{CC(tot)} = 70\text{ mA}$; matched for ISM-434.
 (1) $T_{amb} = -40\text{ }^{\circ}\text{C}$
 (2) $T_{amb} = +25\text{ }^{\circ}\text{C}$
 (3) $T_{amb} = +85\text{ }^{\circ}\text{C}$

Fig 18. Output power at 1 dB gain compression as a function of frequency for ISM-434 application; different temperatures; typical values

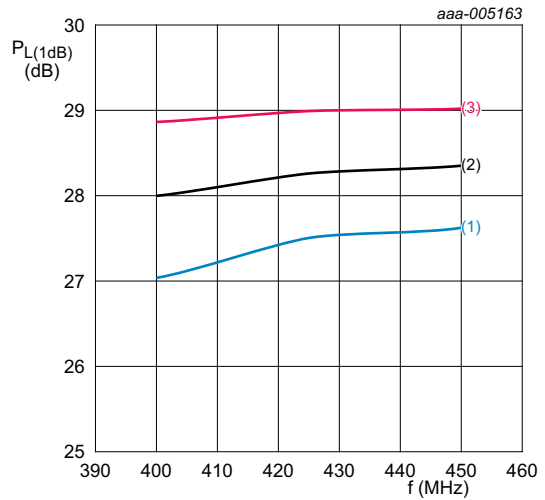

$T_{amb} = 25\text{ }^{\circ}\text{C}$; $I_{CC(tot)} = 70\text{ mA}$; matched for ISM-434.
 (1) $V_{SUP} = 3.3\text{ V}$
 (2) $V_{SUP} = 3.6\text{ V}$
 (3) $V_{SUP} = 3.9\text{ V}$

Fig 19. Output power at 1 dB gain compression as a function of frequency for ISM-434 application; different supply voltages; typical values

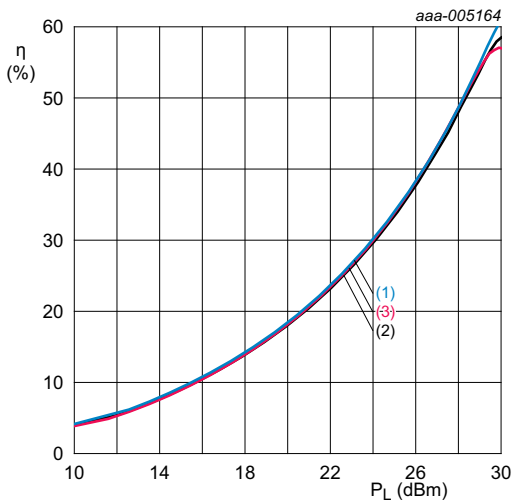

$V_{SUP} = 3.6\text{ V}$; $I_{CC(tot)} = 70\text{ mA}$; matched for ISM-434.
 (1) $T_{amb} = -40\text{ }^{\circ}\text{C}$
 (2) $T_{amb} = +25\text{ }^{\circ}\text{C}$
 (3) $T_{amb} = +85\text{ }^{\circ}\text{C}$

Fig 20. Efficiency as a function of output power for ISM-434 application; different temperatures; typical values

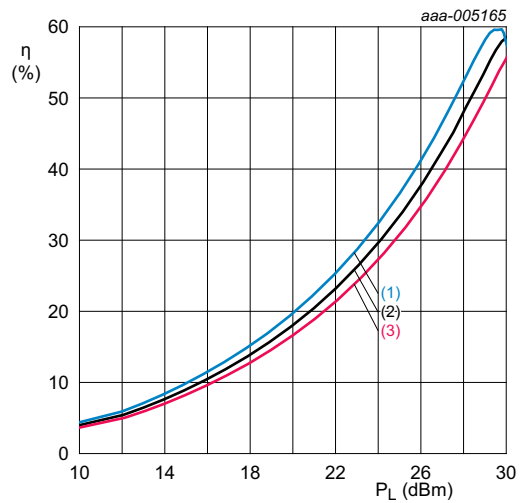

$T_{amb} = 25\text{ }^{\circ}\text{C}$; $I_{CC(tot)} = 70\text{ mA}$; matched for ISM-434.
 (1) $V_{SUP} = 3.3\text{ V}$
 (2) $V_{SUP} = 3.6\text{ V}$
 (3) $V_{SUP} = 3.9\text{ V}$

Fig 21. Efficiency as a function of output power for ISM-434 application; different supply voltages; typical values

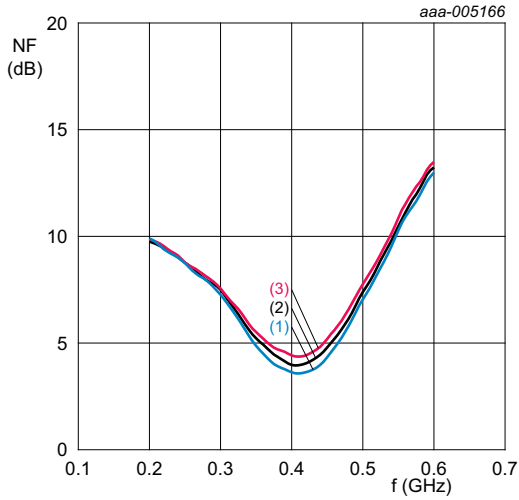

$V_{SUP} = 3.6\text{ V}$; $I_{CC(tot)} = 70\text{ mA}$; matched for ISM-434.
 (1) $T_{amb} = -40\text{ }^{\circ}\text{C}$
 (2) $T_{amb} = +25\text{ }^{\circ}\text{C}$
 (3) $T_{amb} = +85\text{ }^{\circ}\text{C}$

Fig 22. Noise figure as a function of frequency for ISM-434 application; different temperatures; typical values

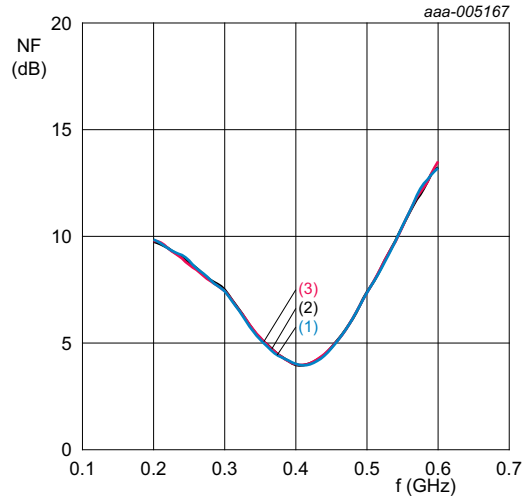

$T_{amb} = 25\text{ }^{\circ}\text{C}$; $I_{CC(tot)} = 70\text{ mA}$; matched for ISM-434.
 (1) $V_{SUP} = 3.3\text{ V}$
 (2) $V_{SUP} = 3.6\text{ V}$
 (3) $V_{SUP} = 3.9\text{ V}$

Fig 23. Noise figure as a function of frequency for ISM-434 application; different supply voltages; typical values

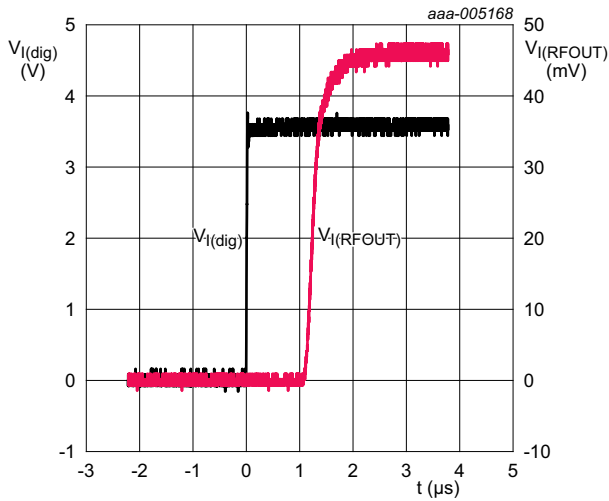

$V_{SUP} = 3.6\text{ V}$; $I_{CC(tot)} = 70\text{ mA}$; matched for ISM-434.

Fig 24. Power-on delay time; typical values

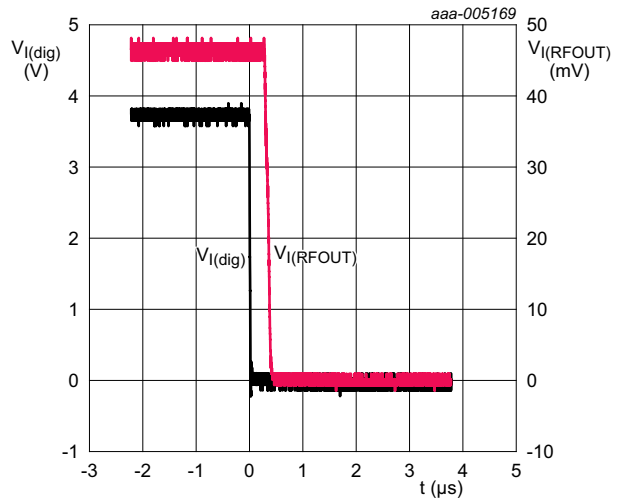

$V_{SUP} = 3.6\text{ V}$; $I_{CC(tot)} = 70\text{ mA}$; matched for ISM-434.

Fig 25. Power-down delay time; typical values

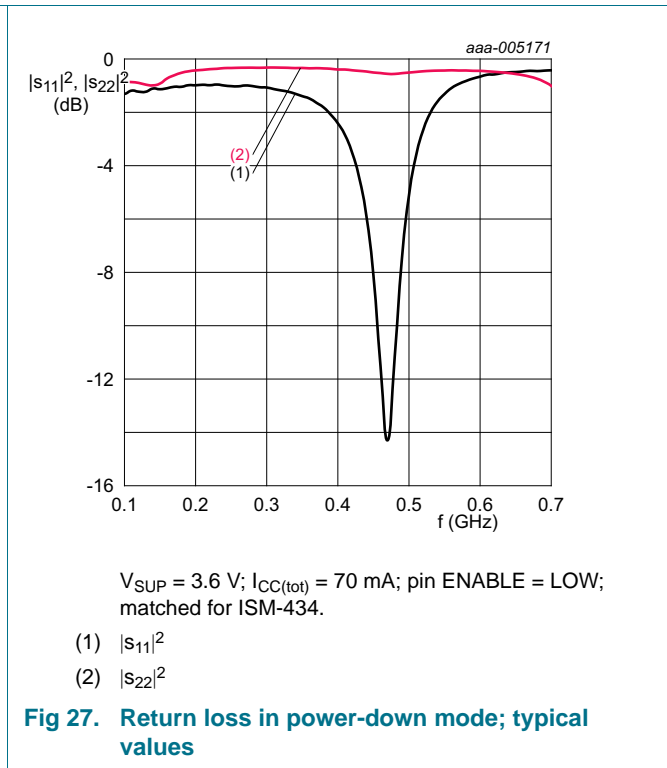
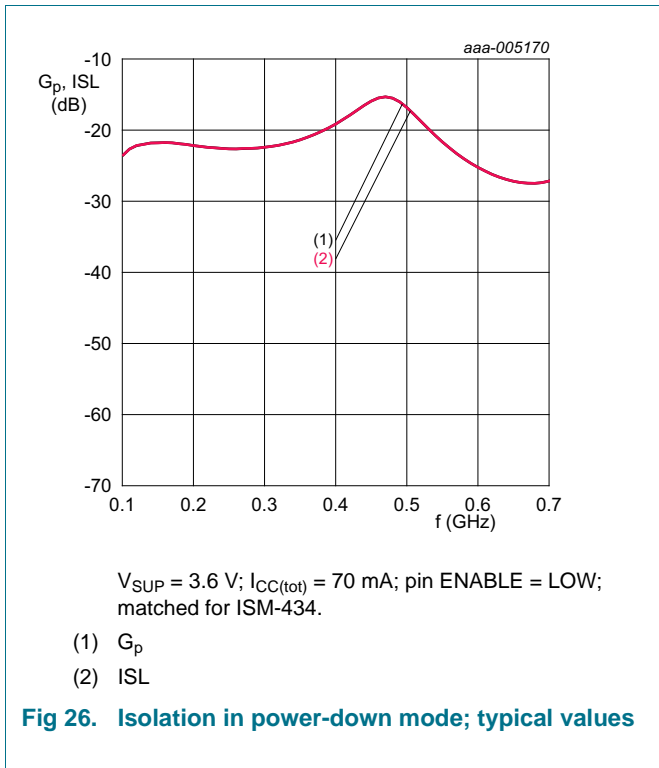

14.3 Characteristics ISM-915

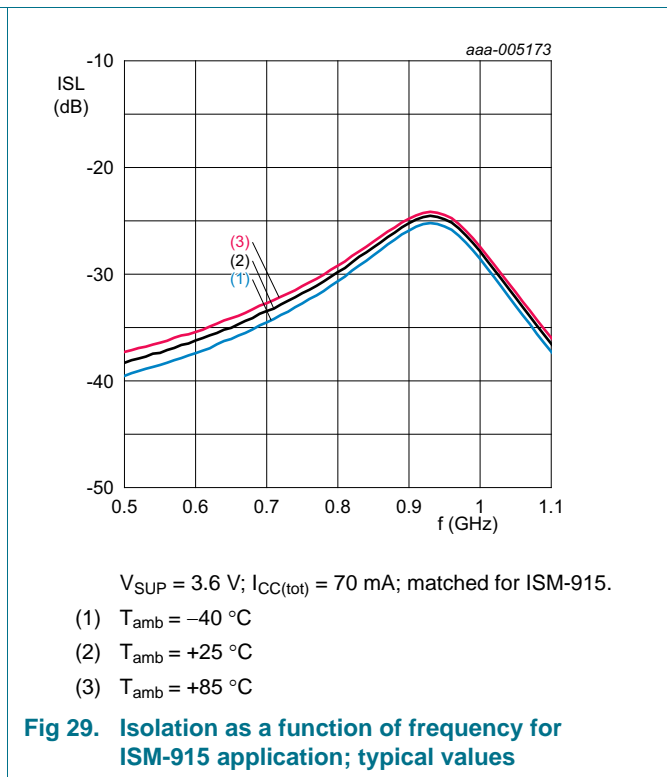
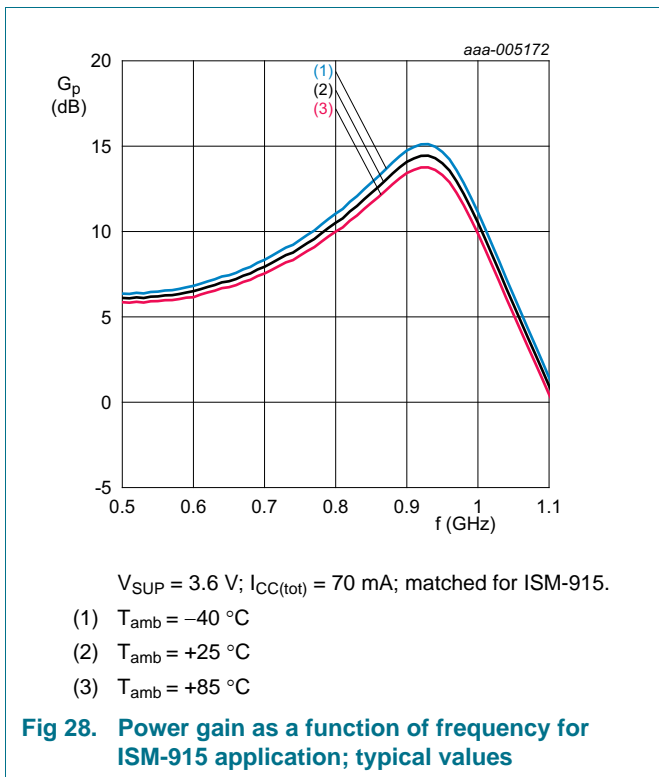

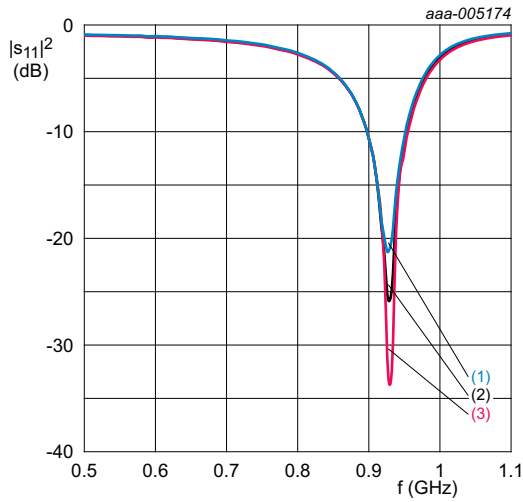

$V_{SUP} = 3.6\text{ V}; I_{CC(tot)} = 70\text{ mA};$ matched for ISM-915.
 (1) $T_{amb} = -40\text{ }^{\circ}\text{C}$
 (2) $T_{amb} = +25\text{ }^{\circ}\text{C}$
 (3) $T_{amb} = +85\text{ }^{\circ}\text{C}$

Fig 30. Input return loss as a function of frequency for ISM-915 application; typical values

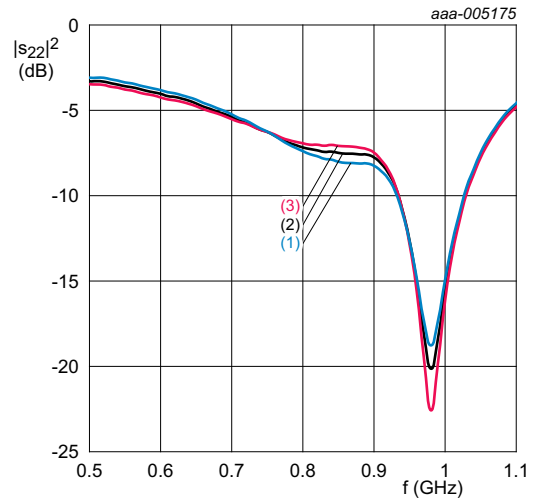

$V_{SUP} = 3.6\text{ V}; I_{CC(tot)} = 70\text{ mA};$ matched for ISM-915.
 (1) $T_{amb} = -40\text{ }^{\circ}\text{C}$
 (2) $T_{amb} = +25\text{ }^{\circ}\text{C}$
 (3) $T_{amb} = +85\text{ }^{\circ}\text{C}$

Fig 31. Output return loss as a function of frequency for ISM-915 application; typical values

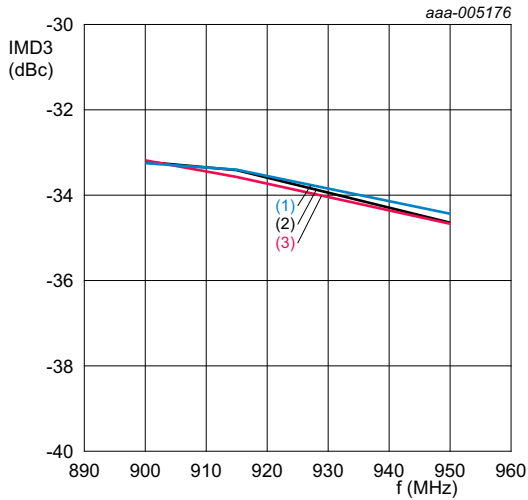

$V_{SUP} = 3.6\text{ V}; I_{CC(tot)} = 70\text{ mA}; P_L = 15\text{ dBm}$ per tone;
 $\Delta f = 1\text{ MHz};$ matched for ISM-915.
 (1) $T_{amb} = -40\text{ }^{\circ}\text{C}$
 (2) $T_{amb} = +25\text{ }^{\circ}\text{C}$
 (3) $T_{amb} = +85\text{ }^{\circ}\text{C}$

Fig 32. Third order intermodulation distortion as a function of frequency for ISM-915 application; different temperatures; typical values

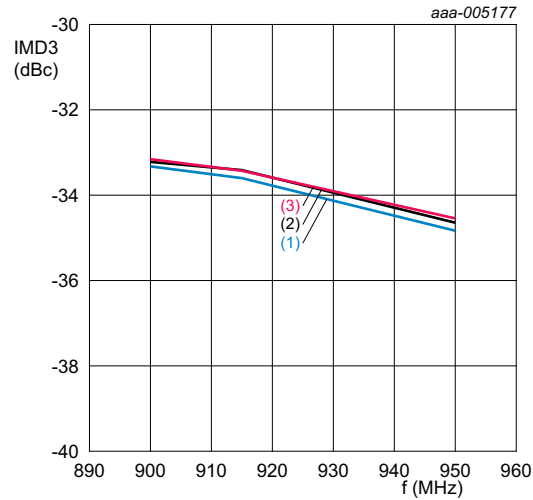

$T_{amb} = 25\text{ }^{\circ}\text{C}; I_{CC(tot)} = 70\text{ mA}; P_L = 15\text{ dBm}$ per tone;
 $\Delta f = 1\text{ MHz};$ matched for ISM-915.
 (1) $V_{SUP} = 3.3\text{ V}$
 (2) $V_{SUP} = 3.6\text{ V}$
 (3) $V_{SUP} = 3.9\text{ V}$

Fig 33. Third order intermodulation distortion as a function of frequency for ISM-915 application; different supply voltages; typical values

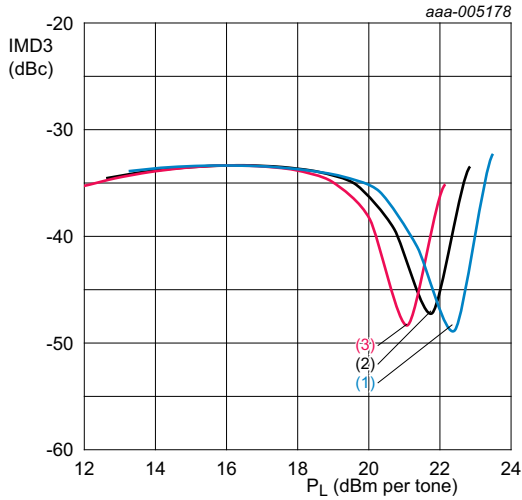

$V_{SUP} = 3.6\text{ V}$; $I_{CC(tot)} = 70\text{ mA}$; $\Delta f = 1\text{ MHz}$; matched for ISM-915.

- (1) $T_{amb} = -40\text{ }^{\circ}\text{C}$
- (2) $T_{amb} = +25\text{ }^{\circ}\text{C}$
- (3) $T_{amb} = +85\text{ }^{\circ}\text{C}$

Fig 34. Third order intermodulation distortion as a function of output power for ISM-915 application; different temperatures; typical values

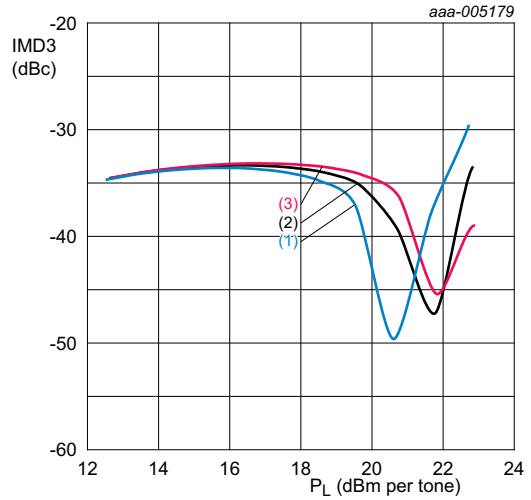

$T_{amb} = 25\text{ }^{\circ}\text{C}$; $I_{CC(tot)} = 70\text{ mA}$; $\Delta f = 1\text{ MHz}$; matched for ISM-915.

- (1) $V_{SUP} = 3.3\text{ V}$
- (2) $V_{SUP} = 3.6\text{ V}$
- (3) $V_{SUP} = 3.9\text{ V}$

Fig 35. Third order intermodulation distortion as a function of output power for ISM-915 application; different supply voltages; typical values

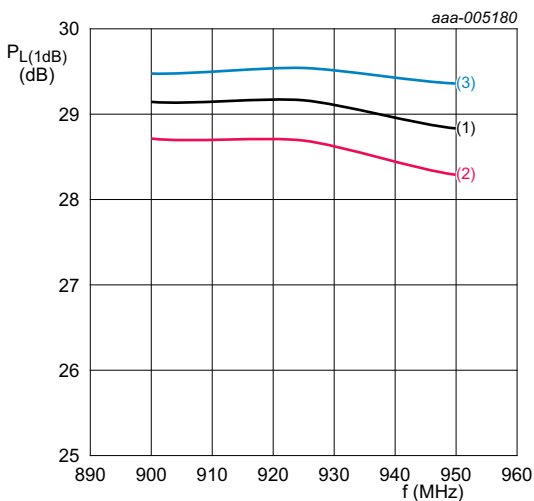

$V_{SUP} = 3.6\text{ V}$; $I_{CC(tot)} = 70\text{ mA}$; matched for ISM-915.

- (1) $T_{amb} = -40\text{ }^{\circ}\text{C}$
- (2) $T_{amb} = +25\text{ }^{\circ}\text{C}$
- (3) $T_{amb} = +85\text{ }^{\circ}\text{C}$

Fig 36. Output power at 1 dB gain compression as a function of frequency for ISM-915 application; different temperatures; typical values

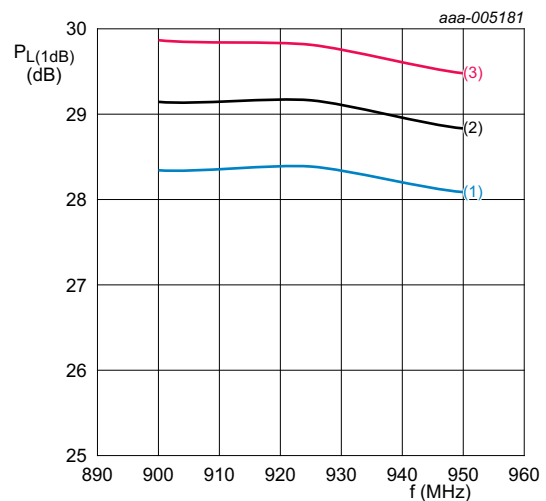

$T_{amb} = 25\text{ }^{\circ}\text{C}$; $I_{CC(tot)} = 70\text{ mA}$; matched for ISM-915.

- (1) $V_{SUP} = 3.3\text{ V}$
- (2) $V_{SUP} = 3.6\text{ V}$
- (3) $V_{SUP} = 3.9\text{ V}$

Fig 37. Output power at 1 dB gain compression as a function of frequency for ISM-915 application; different supply voltages; typical values

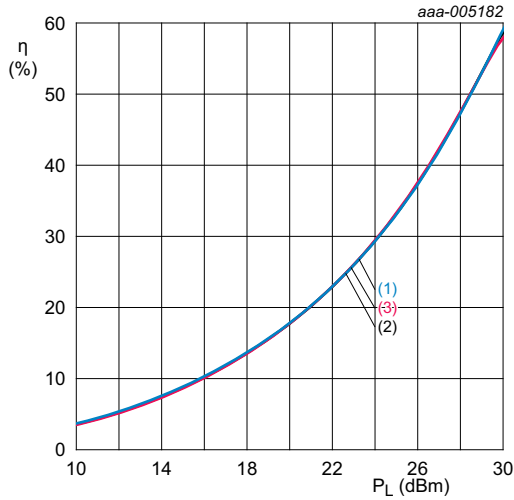

$V_{SUP} = 3.6\text{ V}$; $I_{CC(tot)} = 70\text{ mA}$; matched for ISM-915.
 (1) $T_{amb} = -40\text{ °C}$
 (2) $T_{amb} = +25\text{ °C}$
 (3) $T_{amb} = +85\text{ °C}$

Fig 38. Efficiency as a function of output power for ISM-915 application; different temperatures; typical values

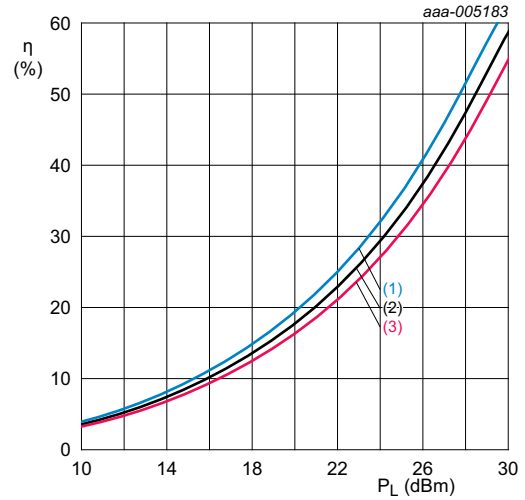

$T_{amb} = 25\text{ °C}$; $I_{CC(tot)} = 70\text{ mA}$; matched for ISM-915.
 (1) $V_{SUP} = 3.3\text{ V}$
 (2) $V_{SUP} = 3.6\text{ V}$
 (3) $V_{SUP} = 3.9\text{ V}$

Fig 39. Efficiency as a function of output power for ISM-915 application; different supply voltages; typical values

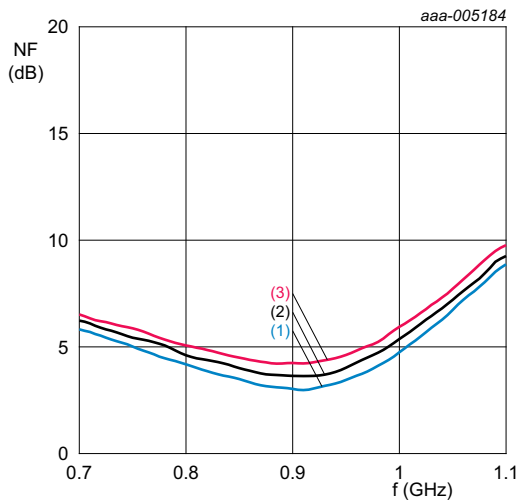

$V_{SUP} = 3.6\text{ V}$; $I_{CC(tot)} = 70\text{ mA}$; matched for ISM-915.
 (1) $T_{amb} = -40\text{ °C}$
 (2) $T_{amb} = +25\text{ °C}$
 (3) $T_{amb} = +85\text{ °C}$

Fig 40. Noise figure as a function of frequency for ISM-915 application; different temperatures; typical values

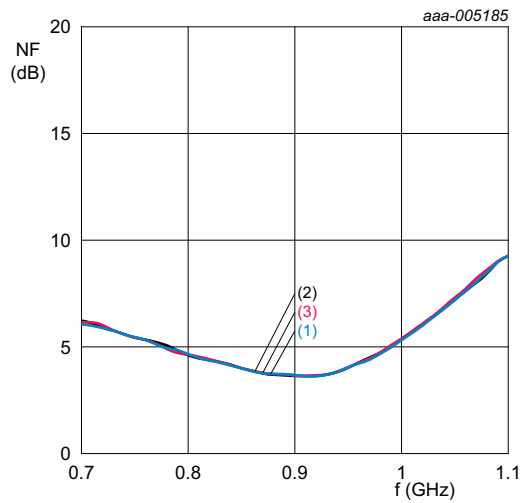

$T_{amb} = 25\text{ °C}$; $I_{CC(tot)} = 70\text{ mA}$; matched for ISM-915.
 (1) $V_{SUP} = 3.3\text{ V}$
 (2) $V_{SUP} = 3.6\text{ V}$
 (3) $V_{SUP} = 3.9\text{ V}$

Fig 41. Noise figure as a function of frequency for ISM-915 application; different supply voltages; typical values

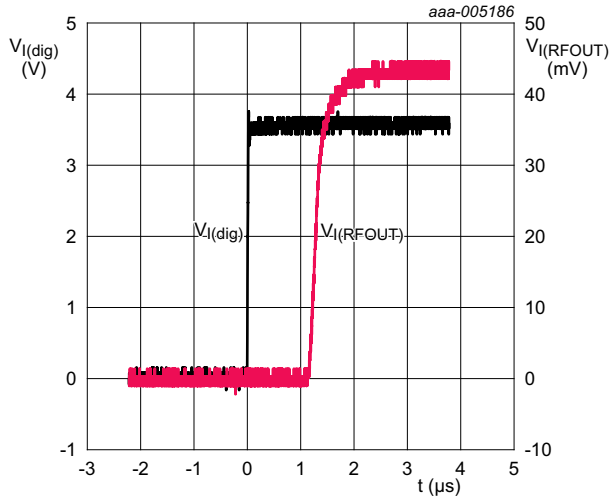

$V_{\text{SUP}} = 3.6 \text{ V}$; $I_{\text{CC}(\text{tot})} = 70 \text{ mA}$; matched for ISM-915.

Fig 42. Power-on delay time; typical values

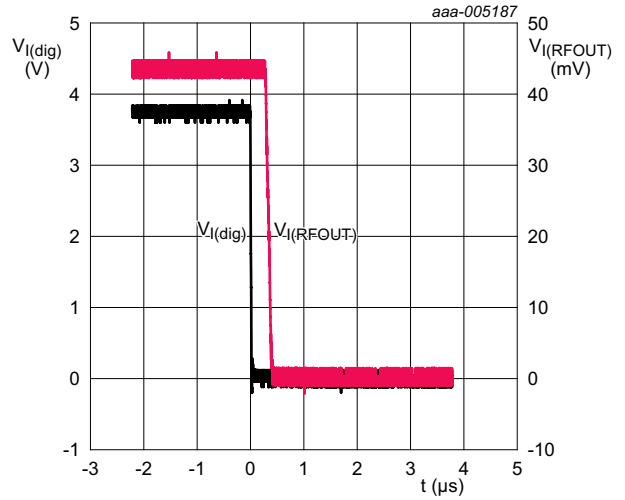

$V_{\text{SUP}} = 3.6 \text{ V}$; $I_{\text{CC}(\text{tot})} = 70 \text{ mA}$; matched for ISM-915.

Fig 43. Power-down delay time; typical values

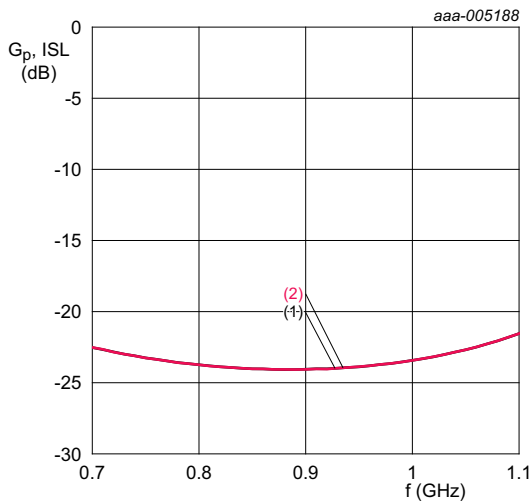

$V_{\text{SUP}} = 3.6 \text{ V}$; $I_{\text{CC}(\text{tot})} = 70 \text{ mA}$; pin ENABLE = LOW; matched for ISM-915.

- (1) G_p
- (2) ISL

Fig 44. Isolation in power-down mode; typical values

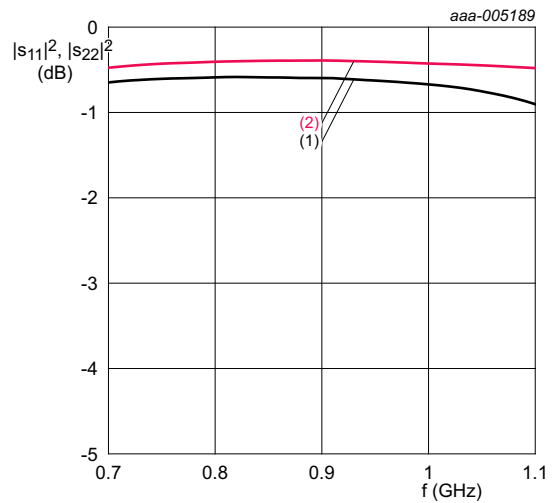

$V_{\text{SUP}} = 3.6 \text{ V}$; $I_{\text{CC}(\text{tot})} = 70 \text{ mA}$; pin ENABLE = LOW; matched for ISM-915.

- (1) $|S_{11}|^2$
- (2) $|S_{22}|^2$

Fig 45. Return loss in power-down mode; typical values

15. Package outline

HVSON8: plastic thermal enhanced very thin small outline package; no leads; 8 terminals; body 3 x 3 x 0.85 mm

SOT908-3

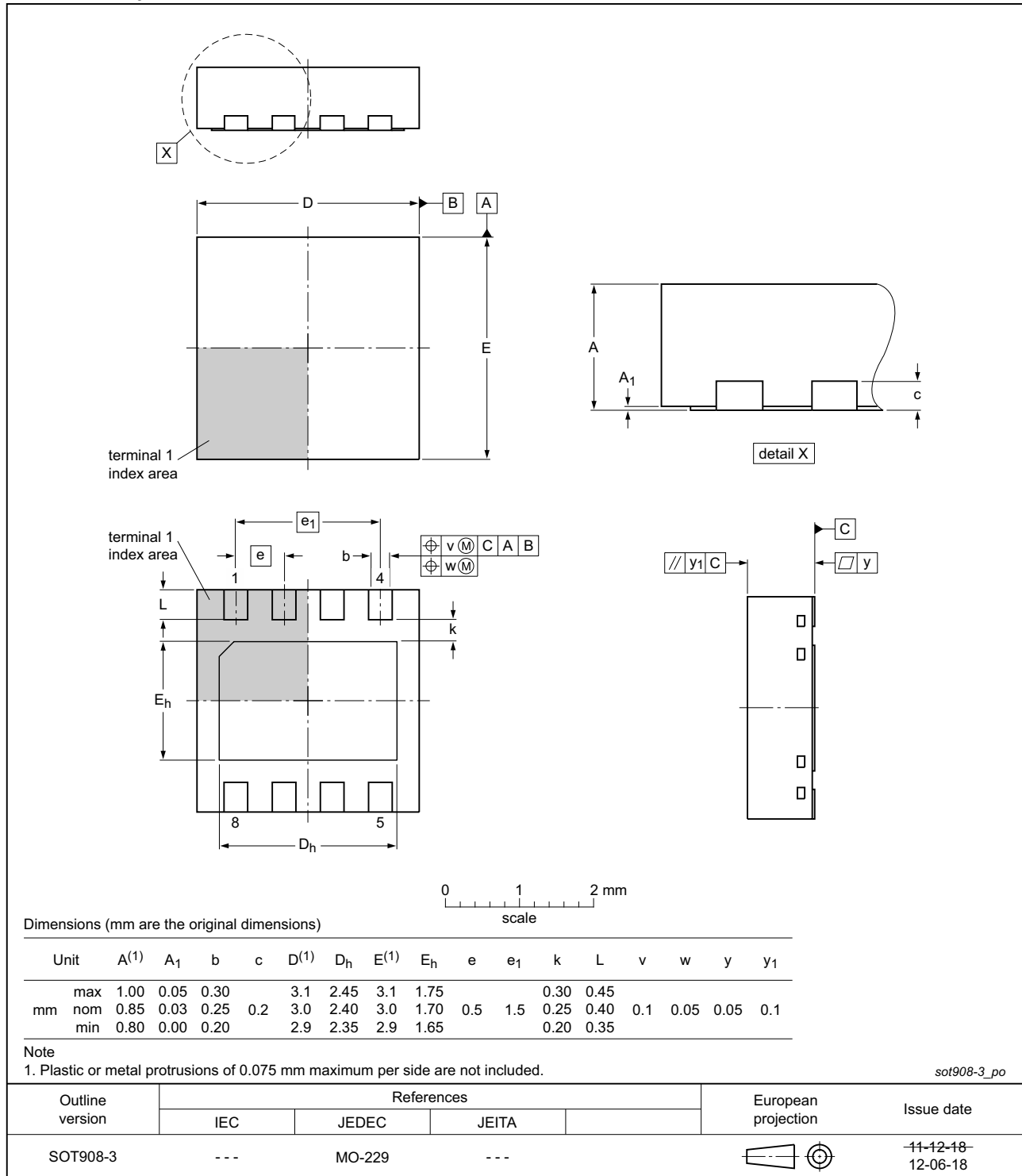
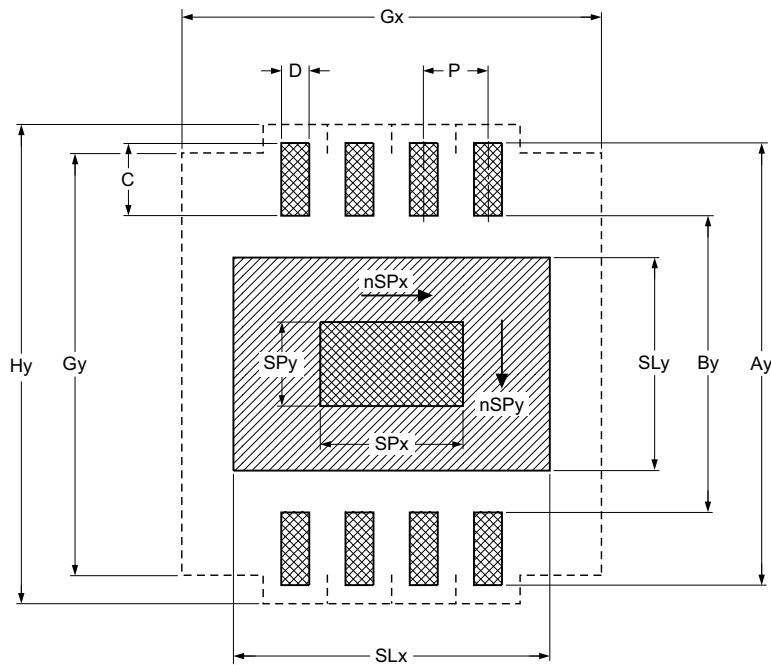

Fig 46. Package outline SOT908-3 (HVSON8)

16. Soldering

Footprint information for reflow soldering of HVSON8 package

SOT908-3



- solder land
- solder paste deposit
- solder land plus solder paste
- occupied area

DIMENSIONS in mm

P	Ay	By	C	D	SLx	SLy	SPx	SPy	Gx	Gy	Hy
0.5	3.45	2.25	0.6	0.25	2.45	1.65	1.1	0.65	3.25	3.25	3.7

nSPx	nSPy
1	1

Issue date ~~12-07-03~~
12-07-12

sot908-3_fr

Fig 47. Reflow soldering footprint

17. Abbreviations

Table 11. Abbreviations

Acronym	Description
CDM	Charged Device Model
CPE	Customer-Premises Equipment
ESD	ElectroStatic Discharge
HBM	Human Body Model
MMIC	Monolithic Microwave Integrated Circuit
MoCA	Multimedia over Coax Alliance
RFID	Radio Frequency IDentification
SMA	Sub-Miniature version A
VSWR	Voltage Standing-Wave Ratio
WLAN	Wireless Local Area Network

18. Revision history

Table 12. Revision history

Document ID	Release date	Data sheet status	Change notice	Supersedes
BGA6130 v.2	20140212	Product data sheet	-	BGA6130 v.1
Modifications	<ul style="list-style-type: none"> • Figure 6 on page 10: figure updated • Table 10 on page 12: table updated 			
BGA6130 v.1	20121009	Product data sheet	-	-

19. Legal information

19.1 Data sheet status

Document status ^{[1][2]}	Product status ^[3]	Definition
Objective [short] data sheet	Development	This document contains data from the objective specification for product development.
Preliminary [short] data sheet	Qualification	This document contains data from the preliminary specification.
Product [short] data sheet	Production	This document contains the product specification.

[1] Please consult the most recently issued document before initiating or completing a design.

[2] The term 'short data sheet' is explained in section "Definitions".

[3] The product status of device(s) described in this document may have changed since this document was published and may differ in case of multiple devices. The latest product status information is available on the Internet at URL <http://www.nxp.com>.

19.2 Definitions

Draft — The document is a draft version only. The content is still under internal review and subject to formal approval, which may result in modifications or additions. NXP Semiconductors does not give any representations or warranties as to the accuracy or completeness of information included herein and shall have no liability for the consequences of use of such information.

Short data sheet — A short data sheet is an extract from a full data sheet with the same product type number(s) and title. A short data sheet is intended for quick reference only and should not be relied upon to contain detailed and full information. For detailed and full information see the relevant full data sheet, which is available on request via the local NXP Semiconductors sales office. In case of any inconsistency or conflict with the short data sheet, the full data sheet shall prevail.

Product specification — The information and data provided in a Product data sheet shall define the specification of the product as agreed between NXP Semiconductors and its customer, unless NXP Semiconductors and customer have explicitly agreed otherwise in writing. In no event however, shall an agreement be valid in which the NXP Semiconductors product is deemed to offer functions and qualities beyond those described in the Product data sheet.

19.3 Disclaimers

Limited warranty and liability — Information in this document is believed to be accurate and reliable. However, NXP Semiconductors does not give any representations or warranties, expressed or implied, as to the accuracy or completeness of such information and shall have no liability for the consequences of use of such information. NXP Semiconductors takes no responsibility for the content in this document if provided by an information source outside of NXP Semiconductors.

In no event shall NXP Semiconductors be liable for any indirect, incidental, punitive, special or consequential damages (including - without limitation - lost profits, lost savings, business interruption, costs related to the removal or replacement of any products or rework charges) whether or not such damages are based on tort (including negligence), warranty, breach of contract or any other legal theory.

Notwithstanding any damages that customer might incur for any reason whatsoever, NXP Semiconductors' aggregate and cumulative liability towards customer for the products described herein shall be limited in accordance with the *Terms and conditions of commercial sale* of NXP Semiconductors.

Right to make changes — NXP Semiconductors reserves the right to make changes to information published in this document, including without limitation specifications and product descriptions, at any time and without notice. This document supersedes and replaces all information supplied prior to the publication hereof.

Suitability for use — NXP Semiconductors products are not designed, authorized or warranted to be suitable for use in life support, life-critical or safety-critical systems or equipment, nor in applications where failure or malfunction of an NXP Semiconductors product can reasonably be expected to result in personal injury, death or severe property or environmental damage. NXP Semiconductors and its suppliers accept no liability for inclusion and/or use of NXP Semiconductors products in such equipment or applications and therefore such inclusion and/or use is at the customer's own risk.

Applications — Applications that are described herein for any of these products are for illustrative purposes only. NXP Semiconductors makes no representation or warranty that such applications will be suitable for the specified use without further testing or modification.

Customers are responsible for the design and operation of their applications and products using NXP Semiconductors products, and NXP Semiconductors accepts no liability for any assistance with applications or customer product design. It is customer's sole responsibility to determine whether the NXP Semiconductors product is suitable and fit for the customer's applications and products planned, as well as for the planned application and use of customer's third party customer(s). Customers should provide appropriate design and operating safeguards to minimize the risks associated with their applications and products.

NXP Semiconductors does not accept any liability related to any default, damage, costs or problem which is based on any weakness or default in the customer's applications or products, or the application or use by customer's third party customer(s). Customer is responsible for doing all necessary testing for the customer's applications and products using NXP Semiconductors products in order to avoid a default of the applications and the products or of the application or use by customer's third party customer(s). NXP does not accept any liability in this respect.

Limiting values — Stress above one or more limiting values (as defined in the Absolute Maximum Ratings System of IEC 60134) will cause permanent damage to the device. Limiting values are stress ratings only and (proper) operation of the device at these or any other conditions above those given in the Recommended operating conditions section (if present) or the Characteristics sections of this document is not warranted. Constant or repeated exposure to limiting values will permanently and irreversibly affect the quality and reliability of the device.

Terms and conditions of commercial sale — NXP Semiconductors products are sold subject to the general terms and conditions of commercial sale, as published at <http://www.nxp.com/profile/terms>, unless otherwise agreed in a valid written individual agreement. In case an individual agreement is concluded only the terms and conditions of the respective agreement shall apply. NXP Semiconductors hereby expressly objects to applying the customer's general terms and conditions with regard to the purchase of NXP Semiconductors products by customer.

No offer to sell or license — Nothing in this document may be interpreted or construed as an offer to sell products that is open for acceptance or the grant, conveyance or implication of any license under any copyrights, patents or other industrial or intellectual property rights.

Export control — This document as well as the item(s) described herein may be subject to export control regulations. Export might require a prior authorization from competent authorities.

Quick reference data — The Quick reference data is an extract of the product data given in the Limiting values and Characteristics sections of this document, and as such is not complete, exhaustive or legally binding.

Non-automotive qualified products — Unless this data sheet expressly states that this specific NXP Semiconductors product is automotive qualified, the product is not suitable for automotive use. It is neither qualified nor tested in accordance with automotive testing or application requirements. NXP Semiconductors accepts no liability for inclusion and/or use of non-automotive qualified products in automotive equipment or applications.

In the event that customer uses the product for design-in and use in automotive applications to automotive specifications and standards, customer (a) shall use the product without NXP Semiconductors' warranty of the

product for such automotive applications, use and specifications, and (b) whenever customer uses the product for automotive applications beyond NXP Semiconductors' specifications such use shall be solely at customer's own risk, and (c) customer fully indemnifies NXP Semiconductors for any liability, damages or failed product claims resulting from customer design and use of the product for automotive applications beyond NXP Semiconductors' standard warranty and NXP Semiconductors' product specifications.

Translations — A non-English (translated) version of a document is for reference only. The English version shall prevail in case of any discrepancy between the translated and English versions.

19.4 Trademarks

Notice: All referenced brands, product names, service names and trademarks are the property of their respective owners.

20. Contact information

For more information, please visit: <http://www.nxp.com>

For sales office addresses, please send an email to: salesaddresses@nxp.com

21. Contents

1	General description	1
2	Features and benefits	1
3	Applications	1
4	Quick reference data	2
5	Design support	2
6	Ordering information	3
7	Functional diagram	3
8	Pinning information	4
8.1	Pinning	4
8.2	Pin description	4
9	Functional description	4
9.1	Supply current adjustment	4
9.2	Enable control	5
10	Limiting values	6
11	Thermal characteristics	7
12	Static characteristics	7
13	Dynamic characteristics	8
14	Application information	9
14.1	Application board	9
14.2	Characteristics ISM-434	13
14.3	Characteristics ISM-915	17
15	Package outline	22
16	Soldering	23
17	Abbreviations	24
18	Revision history	24
19	Legal information	25
19.1	Data sheet status	25
19.2	Definitions	25
19.3	Disclaimers	25
19.4	Trademarks	26
20	Contact information	26
21	Contents	27

Please be aware that important notices concerning this document and the product(s) described herein, have been included in section 'Legal information'.

© NXP B.V. 2014.

All rights reserved.

For more information, please visit: <http://www.nxp.com>

For sales office addresses, please send an email to: salesaddresses@nxp.com

Date of release: 12 February 2014

Document identifier: BGA6130

Компания «Life Electronics» занимается поставками электронных компонентов импортного и отечественного производства от производителей и со складов крупных дистрибьюторов Европы, Америки и Азии.

С конца 2013 года компания активно расширяет линейку поставок компонентов по направлению коаксиальный кабель, кварцевые генераторы и конденсаторы (керамические, пленочные, электролитические), за счёт заключения дистрибьюторских договоров

Мы предлагаем:

- Конкурентоспособные цены и скидки постоянным клиентам.
- Специальные условия для постоянных клиентов.
- Подбор аналогов.
- Поставку компонентов в любых объемах, удовлетворяющих вашим потребностям.
- Приемлемые сроки поставки, возможна ускоренная поставка.
- Доставку товара в любую точку России и стран СНГ.
- Комплексную поставку.
- Работу по проектам и поставку образцов.
- Формирование склада под заказчика.
- Сертификаты соответствия на поставляемую продукцию (по желанию клиента).
- Тестирование поставляемой продукции.
- Поставку компонентов, требующих военную и космическую приемку.
- Входной контроль качества.
- Наличие сертификата ISO.

В составе нашей компании организован Конструкторский отдел, призванный помогать разработчикам, и инженерам.

Конструкторский отдел помогает осуществить:

- Регистрацию проекта у производителя компонентов.
- Техническую поддержку проекта.
- Защиту от снятия компонента с производства.
- Оценку стоимости проекта по компонентам.
- Изготовление тестовой платы монтаж и пусконаладочные работы.



Тел: +7 (812) 336 43 04 (многоканальный)

Email: org@lifeelectronics.ru