

## Features

- Digital angular rate sensor with SPI interface
- Angular rate measurement around Z-axis (yaw)
- $\pm 300^\circ/\text{sec}$  input range
- Ultra low noise
- Excellent bias instability
- Low latency
- 24 bit angular rate output
- Embedded temperature sensor for on-chip or external temperature compensation
- Built-in Self-Test
- 5V single supply voltage
- Low operating current consumption: 25mA
- CLCC 30 package: 19.6 mm x 11.5 mm x 3.7 mm
- Weight : 2 grams
- REACH and RoHS compatible

## Applications

- Precision instrumentation
- Platform stabilization
- GPS assistance
- Guidance and control
- IMU, AHRS and navigation systems
- Unmanned vehicles and Autonomous systems
- 3D mapping
- Marine electronics
- Robotics



## General Description

GYPRO® product line is a new generation of Micro-Electro-Mechanical Systems (MEMS) angular rate sensor specifically designed for demanding applications.

The MEMS transducer is manufactured using Tronics proprietary vacuum wafer-level packaging technology based on micro-machined thick single crystal silicon.

The integrated circuit (IC) provides a stable primary anti-phase vibration of the 'drive' proof masses, thanks to electrostatic comb drives. When the sensor is subjected to a rotation, the Coriolis force acts on the 'sense' proof masses and forces them into a secondary anti-phase movement perpendicular to the direction of drive vibration, which is itself counter-balanced by electrostatic forces. The sense closed loop operates as an electromechanical  $\Sigma\Delta$  modulator providing a digital output. This output is finally demodulated using the drive reference signal.

The sensor is factory calibrated and compensated for temperature effects to provide high-accuracy digital output over a broad temperature range.

Raw data output can be also chosen to enable customer-made compensations.

## GYPRO® Product references

	Description	Vibration range	Bandwidth	Latency	Temperature range
<b>GYPRO2300</b>	Standard configuration	4 grms	100Hz	40 ms	-40°C to +85°C
<b>GYPRO2300LD</b>	Low delay configuration	4 grms	>200Hz	2 ms	-40°C to +85°C
<b>GYPRO3300</b>	Improved vibration tolerance & Ultra low delay configuration	8 grms	>200Hz	1 ms	-40°C to +85°C

## Disclaimer

Information furnished by Tronics is believed to be accurate and reliable. However, no responsibility is assumed by Tronics for its use, nor for any infringements of patents or other rights of third parties that may result from its use.

Specification subject to change without notice.

No license is granted by implication or otherwise under any patent or patent rights of Tronics. Trademarks and registered trademarks are the property of their respective owners.

## Contents

<b>Features .....</b>	<b>1</b>
<b>Applications .....</b>	<b>1</b>
<b>General Description .....</b>	<b>1</b>
<b>GYPRO® Product references .....</b>	<b>1</b>
<b>Disclaimer .....</b>	<b>1</b>
Block diagram .....	3
Overall Dimensions .....	3
<b>1. Specifications .....</b>	<b>4</b>
<b>2. Maximum Ratings .....</b>	<b>6</b>
<b>3. Typical performances .....</b>	<b>7</b>
<b>4. Interface .....</b>	<b>9</b>
4.1. Pinout, sensitive axis identification .....	9
4.2. Application circuit .....	9
4.3. Input/Output Pin Definitions .....	10
<b>5. Recommendations .....</b>	<b>11</b>
5.1. Soldering .....	11
5.2. Multi-sensor integration .....	11
<b>6. Digital SPI interface .....</b>	<b>12</b>
6.1. Electrical and Timing Characteristics .....	12
6.2. SPI frames description .....	13
6.3. Angular rate readings .....	13
6.4. Temperature readings .....	13
6.5. Advanced use of SPI registers .....	14
<b>7. Angular rate calibration procedure .....</b>	<b>16</b>
7.1. Algorithm overview .....	16
7.2. Programming of the new coefficients .....	17
7.3. Switch to uncompensated data output .....	18
<b>8. Temperature Sensor Calibration Procedure .....</b>	<b>19</b>
8.1. Temperature sensor calibration model .....	19
8.2. Recommended Procedure .....	19
<b>9. Device Identification / Ordering information .....</b>	<b>20</b>
9.1. Device identification .....	20
9.2. Ordering information .....	20
<b>10. Internal construction and Theory of Operation .....</b>	<b>21</b>
<b>11. Available Tools and Resources .....</b>	<b>22</b>

Block diagram

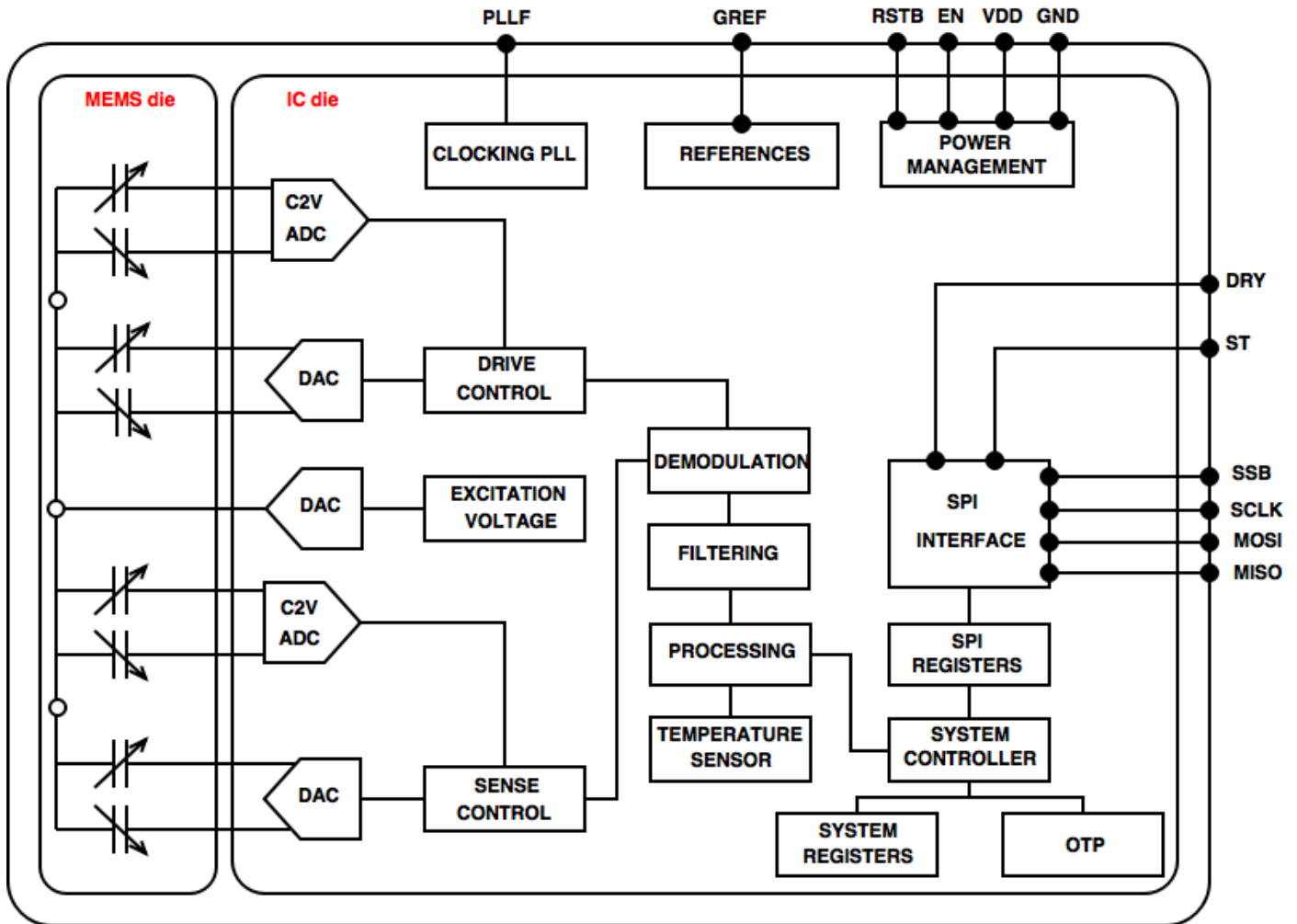

Overall Dimensions

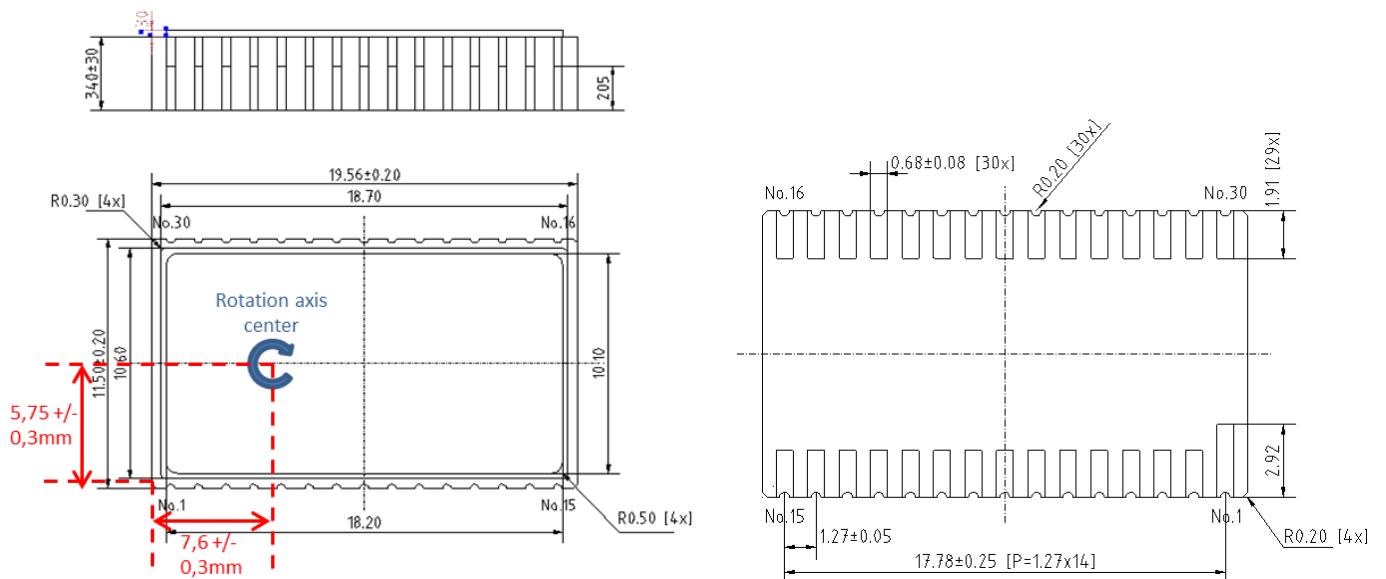

## 1. Specifications

Parameter	Unit	Typ.	Max	Notes
<b>Measurement Ranges</b>				
Input range*	°/s	±300	±838	
Temperature range *	°C	-40 to +85		
<b>Bias</b>				
Bias instability	°/h	0.8	3**	Lowest point of Allan variance curve at room temperature.
Bias in-run (short term) stability	°/h	10	30**	Standard deviation of the 1 second filtered output over 1 hour at room temperature, after 30 min of stabilization.
Bias temperature variations (1σ), calibrated *	°/s	0.02	0.05	Standard deviation of the bias over the specified temperature range. Factory calibration is performed in test socket. As printed circuit board reflow soldering may cause shifts in bias temperature variations, it may be necessary to do an on-board calibration after soldering, depending on applications requirements.
Bias run to run repeatability	°/h	10		Standard deviation of 7 bias measurements at 30°C that occurs between seven runs of operation with 30 minutes power off between each run.
Vibration rectification coefficient	°/h/g <sup>2</sup>	0.5		Bias rectification under operating vibration, overall level 7.3 g rms, test condition B, method 2026, MIL-STD-883F.
<b>Scale Factor</b>				
Scale Factor *	LSB/°/s	10 000		Nominal scale factor.
Scale Factor temperature variations (1σ), calibrated *	%	0.04	0.15	Standard deviation of the scale factor over the specified temperature range.
Scale Factor run to run repeatability	ppm	25	100**	Standard deviation of 7 scale factor measurements at 30°C that occurs between seven runs of operation with 30 minutes power off between each run.
Scale factor non linearity*	ppm	100	500	Maximum deviation of the output from the expected value using a best fit straight line, at room temperature.
<b>Noise</b>				
RMS Noise [1-100Hz] *	°/s	0.03	0.05	RMS noise level in the band [1-100Hz], obtained by integrating the power spectral density of the sensor output between 1 and 100Hz at zero rate and room temperature.
Angular random walk	°/√h	0.15	0.3**	-1/2 slope of Allan variance curve at room temperature.
<b>Frequency response</b>				
Bandwidth	Hz	>200Hz		Defined as the frequency for which attenuation is equal to -3dB
Data Rate	Hz	1700 to 1900		Refresh rate of the output data at room temperature.
Latency	ms	1		Time interval between the implementation of a rate signal on the input and the availability of the corresponding data on the output.
Start-up Time	s	0.5	1**	Time interval between application of power on and the availability of an output signal (at least 90% of the input rate), at room temperature.

Parameter	Unit	Typ.	Max	Notes
<b>Linear acceleration</b>				
G sensitivity	°/h/g	15	40**	Mean value on all axis of output variation under 1 g.
Recovery time	ms	10		Time interval between an impact (half sine 50 g, 6 ms) and the presence of a usable output of the sensor.
<b>Axis alignment</b>				
Rate axis misalignment	mrad		16	Misalignment between the sensitive axis and the normal to the package bottom plane, by design.
<b>Environmental</b>				
Storage temperature range	°C	-55 to +100		
Humidity at 45°C	%	<98		
Moisture Sensitivity Level (MSL)	--	1		Unlimited floor life out of the bag (hermetic package).
Shock (operating)	g   ms	50   6		Half sine.
Shock (survival)	g   ms	2000   0.3		
Vibrations (operating)	g <sub>rms</sub>	7.3		test condition B, method 2026, MIL-STD-883F.
Vibrations (survival)	g <sub>rms</sub>	20		
<b>Electrical</b>				
Power Supply Voltage	V	4.75 to 5.25		
Current consumption (normal mode)	mA	25		
Current consumption (power down mode)	µA	1	<5	Power down mode is activated by switching EN pin to GND.
Power supply rejection ratio	°/h/V	40		
<b>Temperature sensor</b>				
Scale Factor (raw data)	LSB/°C	85		Temperature sensor is not factory-calibrated.
25°C typical output (raw data)	LSB	8000		Temperature sensor is not factory-calibrated.
Refresh rate	Hz	6		
<b>Reliability</b>				
MTBF	Hr	270 000		Predictive elapsed time between inherent failures of the sensor during normal system operation.

**Table 1 Specifications**

\* 100% tested in production.

\*\* Unless otherwise specified, max values are ±3 sigma variation limits from validation test population.

## 2. Maximum Ratings

Stresses higher than the maximum ratings listed below may cause permanent damage to the device, or affect its reliability. Functional operation is not guaranteed once stresses higher than the maximum ratings have been applied.

Exposure to maximum ratings conditions for extended periods may also affect device reliability.

Parameter	Unit	Min	Max
Supply Voltage	V	-0.5	+7
Electrostatic Discharge (ESD) protection, any pin, Human Body Model	kV	--	±2
Storage temperature range	°C	-55	+100
Shock survival	g	--	2000
Vibrations survival, 20-2000Hz	g <sub>rms</sub>	--	20
Ultrasonic cleaning		Not allowed	

Table 2 Maximum ratings

### Caution!



The product may be damaged by ESD, which can cause performance degradation or device failure! We recommend handling the device only on a static safe work station. Precaution for the storage should also be taken.



The sensor **MUST** be powered-on *before* any SPI operation, as shown in Figure 1 below. Having the SPI pads, VDDIO or EN at a high level while VDD is at a low level could damage the sensor, due to ESD protection diodes and buffers.

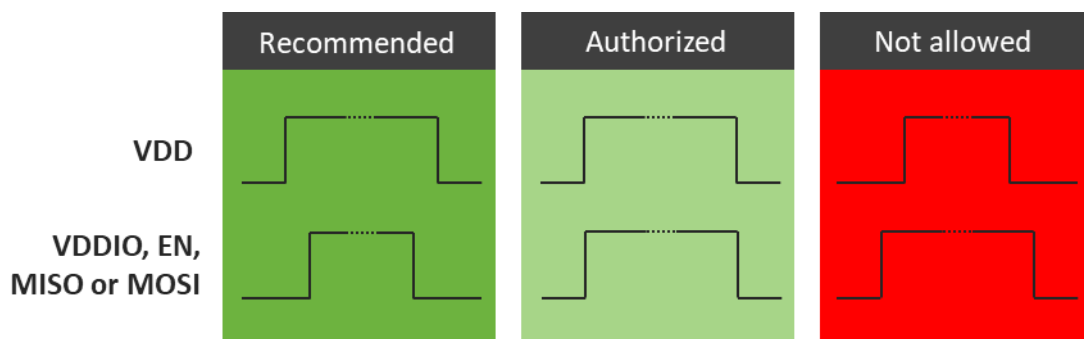

Figure 1: Recommended voltage sequence.

### 3. Typical performances

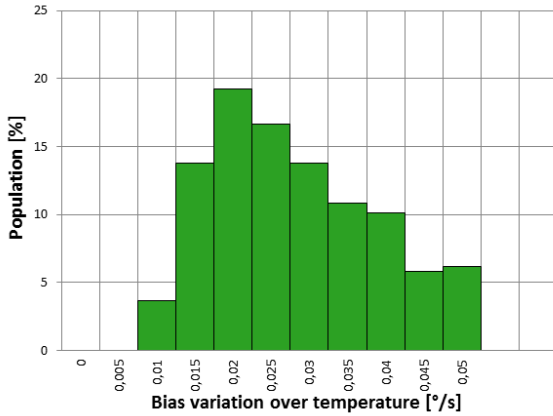

Figure 2 Distribution of bias over temperature

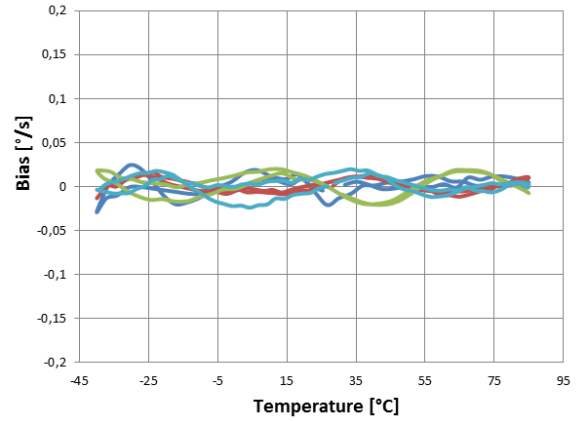

Figure 5 Bias variation over temperature (4 samples)

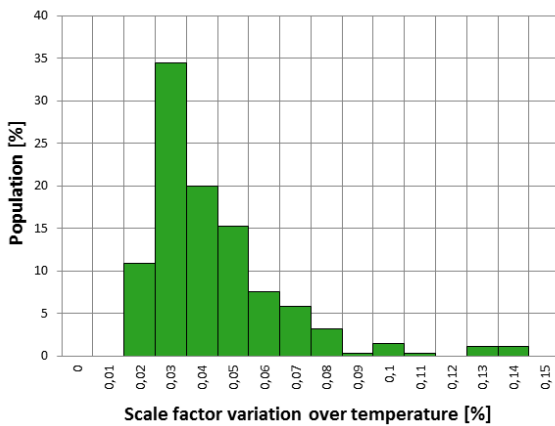

Figure 3 Distribution of scale factor over temperature

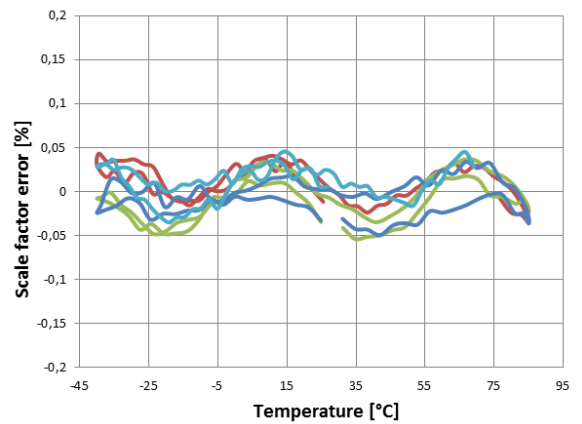

Figure 6 Scale factor variation over temperature (4 samples)

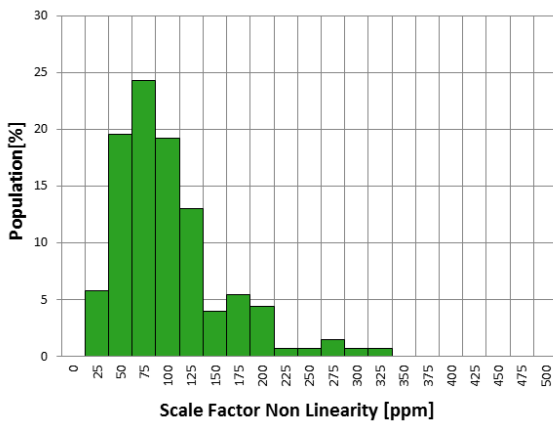

Figure 4 Distribution of scale factor non linearity (RT)

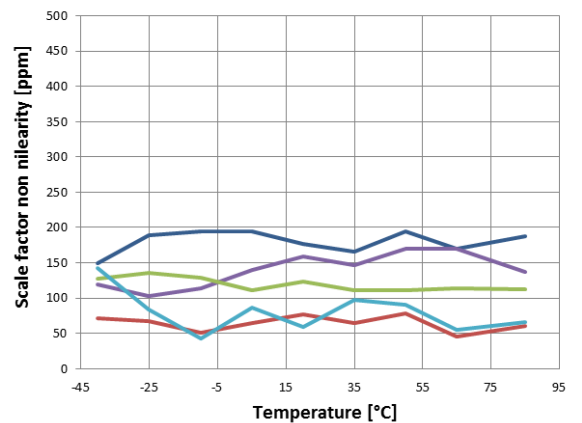

Figure 7 Scale factor non linearity over temperature (5 samples)

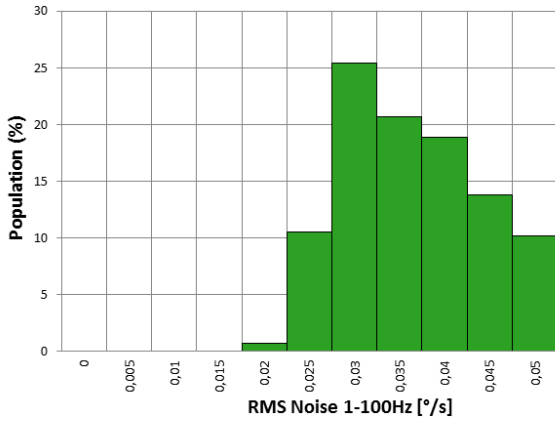

Figure 8 Distribution of RMS Noise (RT)

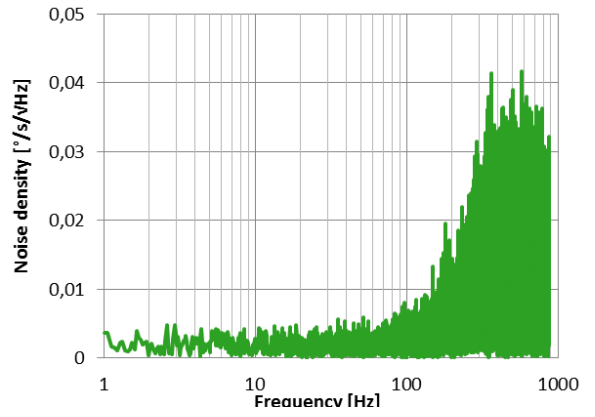

Figure 11 Noise density (RT)

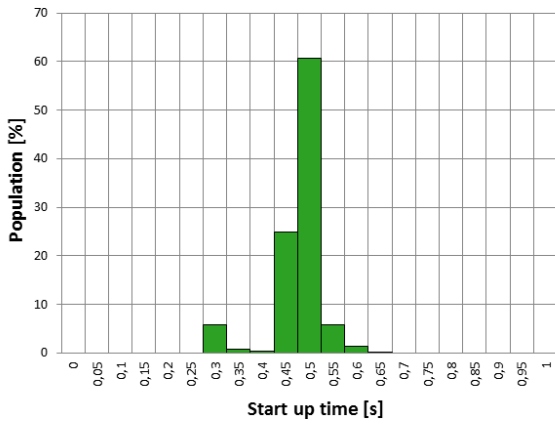

Figure 9 Distribution of Start-Up time (RT)

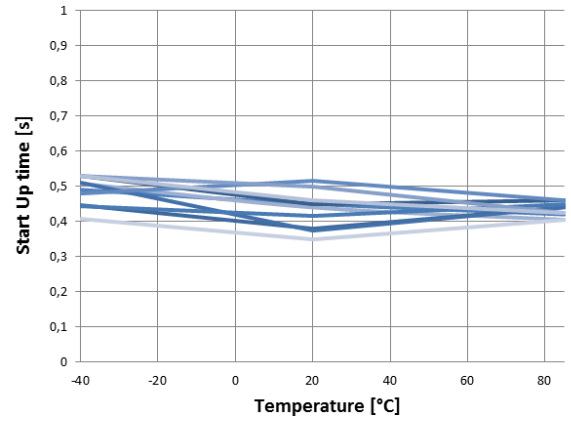

Figure 12 Start-up time variation over temperature

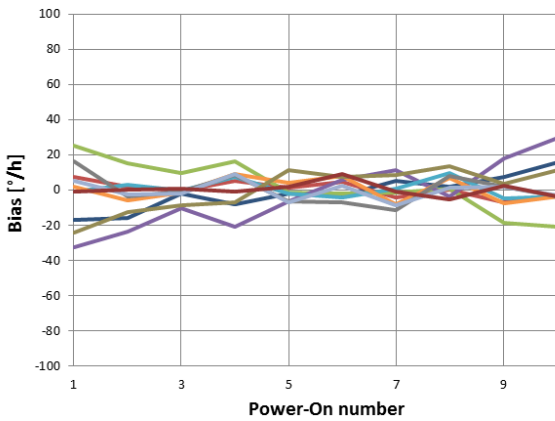

Figure 10 Run to run bias repeatability (30°C)

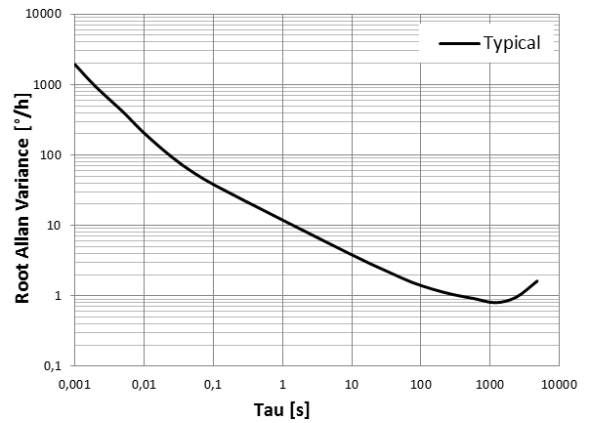

Figure 13 Allan variance (RT)



## 4. Interface

### 4.1. Pinout, sensitive axis identification

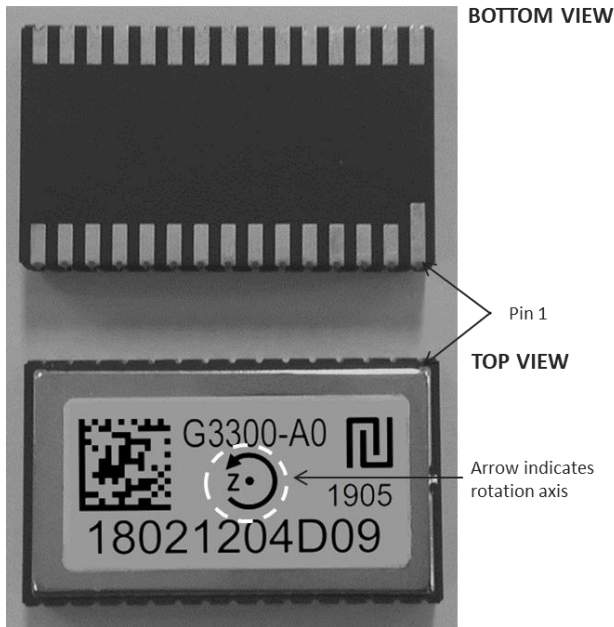

Figure 14: How to locate Pin 1

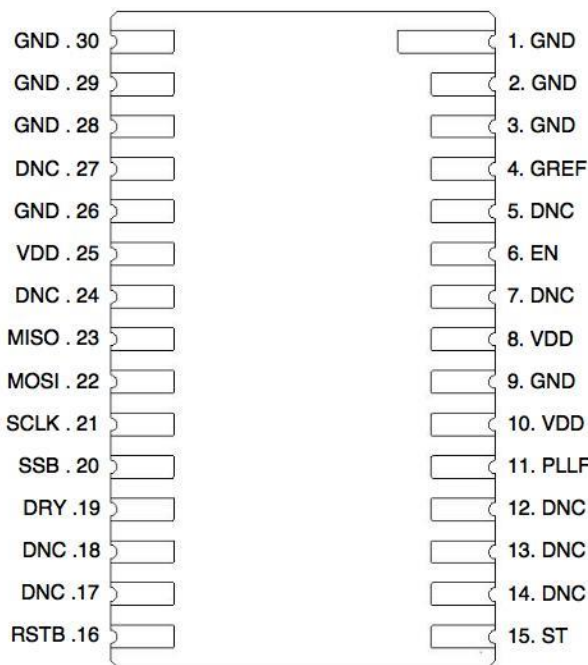

Figure 15: GYPRO3300 Sensors Pinout (bottom view)

### 4.2. Application circuit

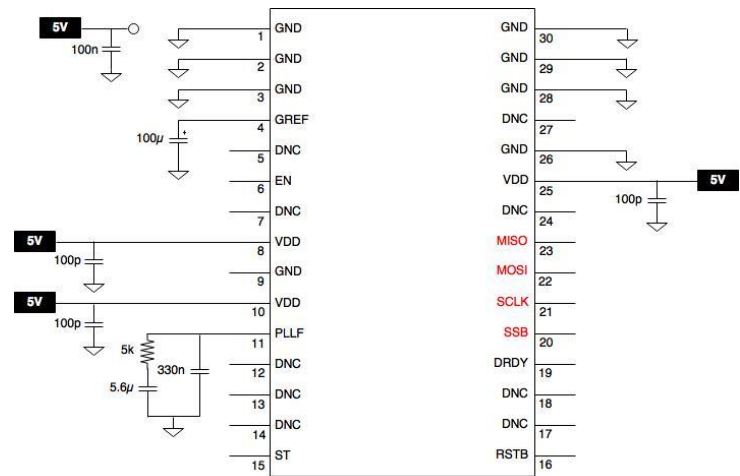

Figure 16: Recommended Application Schematic (top view)

#### Notes:

- All capacitances of Figure 16 should be placed as close as possible to their corresponding pins, except the 100nF capacitance between VDD and GND, which should be as close as possible to the board's supply input.
- The 100µF filtering capacitance between GREF and GND should have low Equivalent Series Resistance (ESR < 1Ω) and low leakage current (< 6µA). A tantalum capacitor is recommended.
- 5.6µF and 330nF filtering capacitance between PLLF and GND should have a low leakage current (< 1µA).

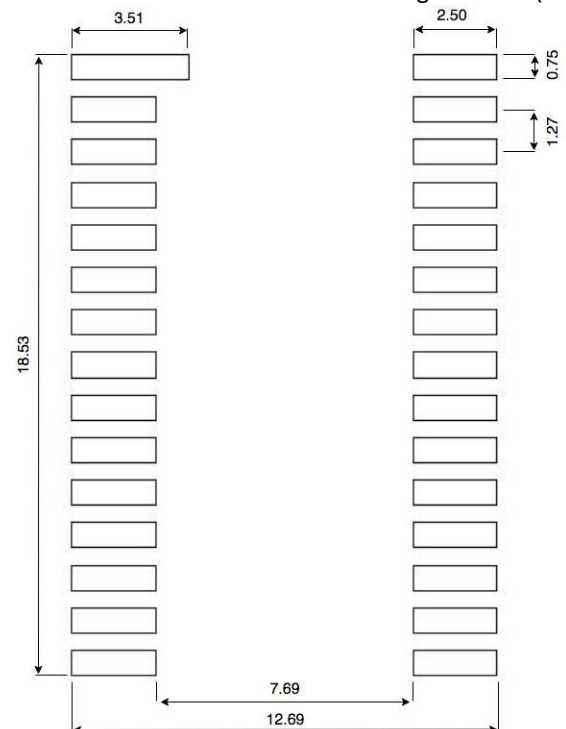

Figure 17: Recommended Pad Layout in mm (top view)

### 4.3. Input/Output Pin Definitions

Pin name	Pin number	Pin type	Pin direction	Pin levels	Function
<b>GND</b>	1, 2, 3, 9, 26, 28, 29, 30	Supply	n/a	0V	Power Ground
<b>VDD</b>	8, 10, 25	Supply	n/a	+5V	Power Supply
<b>GREF</b>	4	Analog	n/a	4.4V	External decoupling pad. MUST be connected to the board's VSS through a 100µF external capacitor, in order to ensure low noise.
<b>EN</b>	6	Digital	Input	VDD with pull up of 100kΩ	Enable command. Active high.
<b>PLLF</b>	11	Analog	Output	0.8V	External filtering pad. MUST be connected to a filtering stage, described in Figure 16.
<b>ST</b>	15	Digital	Output	VDD	Self-test status. Logic "1" when the sensor is OK.
<b>RSTB</b>	16	Digital	Input	VDD with pull-up of 100kΩ	Reset. Reloads the internal calibration data. Active low
<b>DRY</b>	19	Digital	Output	VDD	Data Ready flag. Generates a pulse when a new angular rate data is available.
<b>SSB</b>	20	Digital	Input	VDD	Slave Selection signal. Active low
<b>SCLK</b>	21	Digital	Input	VDD	SPI clock signal
<b>MOSI</b>	22	Digital	Input	VDD	Master Output Slave Input signal
<b>MISO</b>	23	Digital	Output	VDD	Master Input Slave Output signal
<b>DNC</b>	5, 7, 12, 13, 14, 17, 18, 24, 27	--	--	--	Do Not electrically Connect. These pins provide additional mechanical fixing to the board and should be soldered to an unconnected pad.

Table 3: Pin Functions

Note: The digital pads maximum ratings are GND-0.3V and VDD+0.3V.

## 5. Recommendations

### 5.1. Soldering

Please note that the reflow profile to be used does not depend only on the sensor. The whole populated board characteristics shall be taken into account.

MEMS components are sensitive to mechanical stress coming from the Printed Circuit Board (PCB) during the soldering reflow. This stress is caused by the mismatch between the Coefficient of Thermal Expansion (CTE) of the ceramic package and the PCB and can affect the Bias temperature variations. In order to achieve the best performance, it is recommended to do an on-board calibration after the soldering of the sensor.

For a better reliability of the soldering, Tronics recommends using Copper-Invar-Copper or ceramic boards. These types of boards have a coefficient of thermal expansion (CTE) close to the CTE of GYPRO3300 package (6.8 ppm/°C).

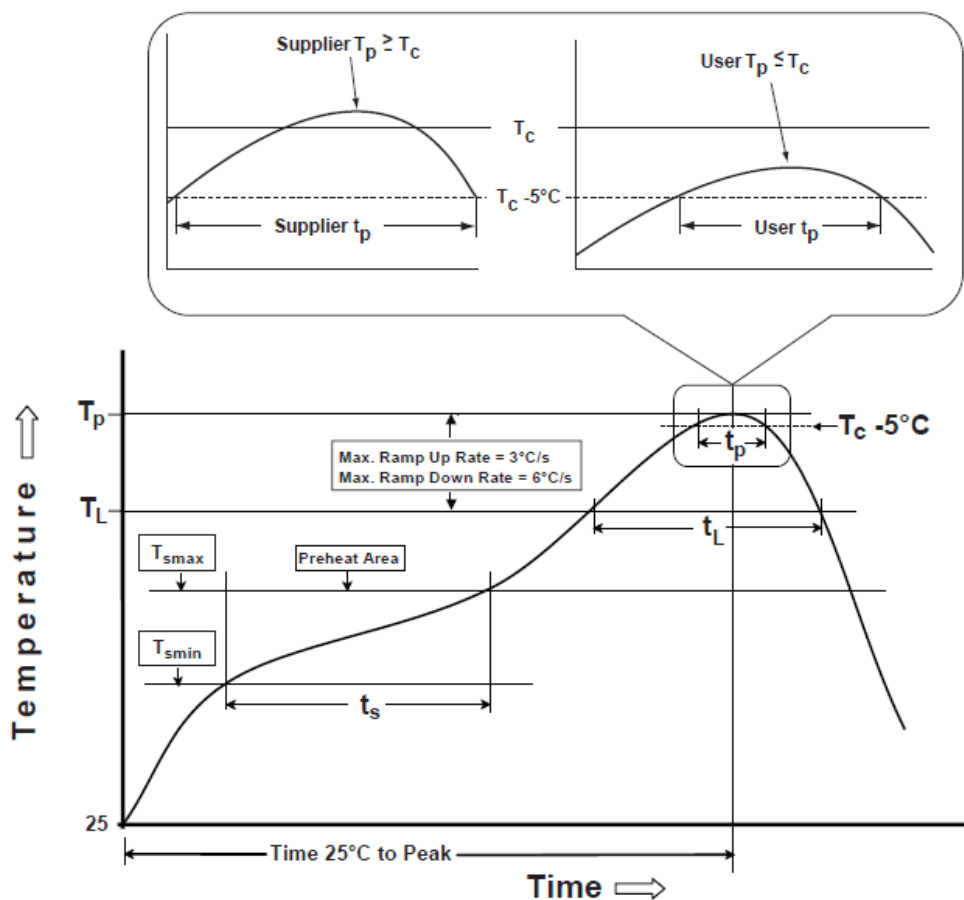

Figure 18: Reflow Profile, according to IPC/JEDEC J-STD-020D.1

Profile Feature	
Time maintained above	
Temperature ( $T_L$ )	183°C
Time ( $t_L$ )	60-150 sec
Peak Temperature ( $T_p$ )	240°C (+/-5°C)
Time within 5°C of Actual Peak Temperature ( $t_p$ )	10-30 sec

Table 4: Reflow Profile Details, according to IPC/JEDEC J-STD-020D.1

### 5.2. Multi-sensor integration

Mechanical coupling between drive frequencies of several sensors can affect performance at system level, for example within Inertial Measurement Units. Customer has to take care of such coupling during system design and validation.

## 6. Digital SPI interface

### 6.1. Electrical and Timing Characteristics

The device acts as a slave supporting only SPI "mode 0" (clock polarity CPOL=0, clock phase CPHA=0).

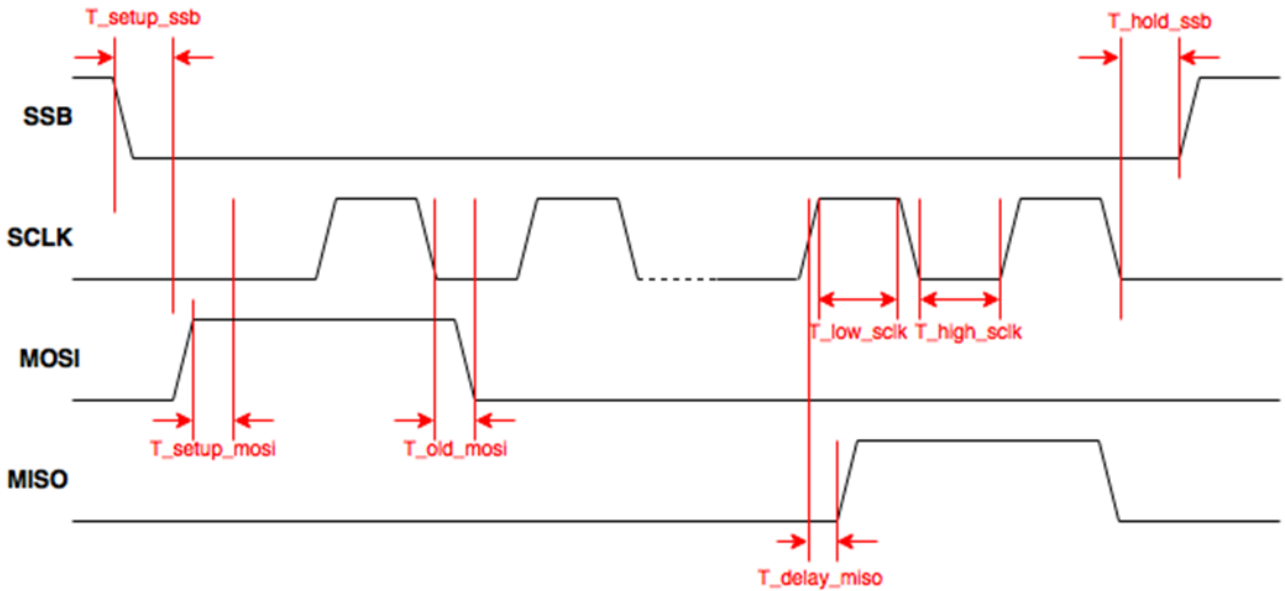

Figure 19: SPI timing diagram

Symbol	Parameter	Condition	Unit	Min	Typ	Max
<b>Electrical characteristics</b>						
VIL	Low level input voltage		VDD	0		0.1
VIH	High level input voltage		VDD	0.8		1
VOL	Low level output voltage	ioL=0mA (Capacitive Load)	V		GND	
VOH	High level output voltage	ioH=0mA (Capacitive Load)	V		VDD	
Rpull_up	Pull-up resistor	Internal pull-up resistance to VDD	kΩ		100	
Rpull_down	Pull-down resistor	Internal pull-down resistance to GND	kΩ		-	
<b>Timing parameters</b>						
Fspi	SPI clock input frequency	Maximal load 25pF on MOSI or MISO	MHz		0.2	8
T_low_sclk	SCLK low pulse		ns	62.5		
T_high_sclk	SCLK high pulse		ns	62.5		
T_setup_mosi	MOSI setup time		ns	10		
T_hold_mosi	MOSI hold time		ns	5		
T_delay_miso	MISO output delay	Load 25pF	ns			40
T_setup_ssb	SSB setup time		Tsclk	1		
T_hold_ssb	SSB hold time		Tsclk	1		

Table 5: SPI timing parameters

The MISO pin is kept in high impedance when the SSB level is high, which allows sharing the SPI bus with other components.

**IMPORTANT NOTE:** It is forbidden to keep SPI pads at a high level while VDD is at 0V due to ESD protection diodes and buffers.

## 6.2. SPI frames description

The SPI frames used for the communication through the SPI Register are composed of an instruction followed by arguments. The SPI instruction is composed of 1 byte, and the arguments are composed of 2, 4 or 8 bytes, depending on the cases, as can be seen in Table 6 below.



Figure 20: SPI Message Structure

Instruction	Argument	Meaning
0x50	0x00000000 (n=4)	Read Angular Rate
0x54	0x0000 (n=2)	Read Temperature
0x58	0x00000000 (n=4)	Advanced commands. See Section 6.5 for more details.
0x78	0XXXXXXXX (n=8)	
0x7C	0XXXXX (n=2)	

Table 6: Authorized SPI commands

## 6.3. Angular rate readings

From the 32-bits (4 bytes) frame obtained after the “Read Angular Rate” instruction, the 24-bits word of angular rate data (RATE) must be extracted as shown below in Figure 21.

DRY and ST are respectively the “data ready” and “self-test” bits, also directly available on Pins 19 and 16 of the sensor.



Figure 21: Angular rate reading frames and data organization

### 6.3.1. Angular rate (RATE) output

The 24-bit gyro output is coded in two’s complement (Table 7).

- If the temperature compensation is not enabled (GOUT\_SEL=0), then the user should perform scale factor measurements.
- If the temperature compensation of the angular rate output is enabled (default case), dividing the 24-bit value by a factor **10 000** results in the angular rate in  $^{\circ}/s$ , as shown in Table 7.

-838.8608	$^{\circ}/s$	$\Leftrightarrow$	1000 0000 0000 0000 0000 0000
...			
-300.0000	$^{\circ}/s$	$\Leftrightarrow$	1101 0010 0011 1001 0100 0000
...			
-0.0002	$^{\circ}/s$	$\Leftrightarrow$	1111 1111 1111 1111 1111 1110
-0.0001	$^{\circ}/s$	$\Leftrightarrow$	1111 1111 1111 1111 1111 1111
0.0000	$^{\circ}/s$	$\Leftrightarrow$	0000 0000 0000 0000 0000 0000
+0.0001	$^{\circ}/s$	$\Leftrightarrow$	0000 0000 0000 0000 0000 0001
+0.0002	$^{\circ}/s$	$\Leftrightarrow$	0000 0000 0000 0000 0000 0010
...			
+300.0000	$^{\circ}/s$	$\Leftrightarrow$	0010 1101 1100 0110 1100 0000
...			
+838.8607	$^{\circ}/s$	$\Leftrightarrow$	0111 1111 1111 1111 1111 1111

Table 7: Conversion table for calibrated angular rate output

### 6.3.2. Data Ready (DRY) bit

The Data Ready bit is a flag which is raised when a new angular rate data is available. The flag stays raised until the new data is read.

Similarly to the Data Ready pin, the Data Ready bit signal can be used as an interrupt signal to optimize the delays between newly available data and their readings.

### 6.3.3. Self-Test (ST) bit

The ST bit raises a flag (1 logic) at the same frequency as the angular rate output data rate indicating whether the sensor is properly operating (i.e. whether the drive loop control provides stable drive oscillations amplitude).

The self-test procedure is running in parallel to the main functions of the sensor.

The ST data is also available on the pin 15. This pin is set to VDD when the sensor is working properly.

## 6.4. Temperature readings

The temperature data is an unsigned integer, 14-bits word (TEMP). It must be extracted from the 2 bytes of read data, as shown below in Figure 22.

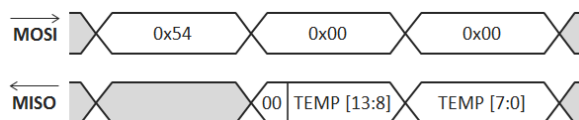

Figure 22: Temperature reading frames and data organization

By default the temperature sensor is *not* factory-calibrated (TOUTSEL=0).

6.5. Advanced use of SPI registers

SPI registers can also be used to access the System register or the MTP (Multi-Time-Programmable memory).

6.5.1. R/W access to the System Registers

**IMPORTANT NOTE:** Modifications to the system registers are **reversible**. Modified registers will *not* be restored after a RESET. There is no limitation to the number of times the system registers can be modified.

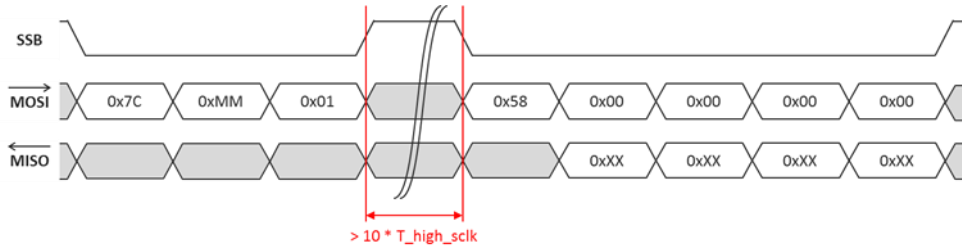

Figure 23: Sequence of instructions to READ address 0xMM of the system registers

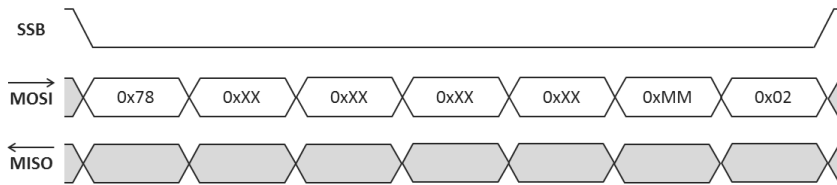

Figure 24: Sequence of instructions to WRITE '0xXXXXXXX' to address '0xMM' of the system registers

6.5.2. R/W access to the MTP

**IMPORTANT NOTE:** Modifications to the MTP are **non-reversible**. Modified parameters will be restored, even after a RESET, and previous values of the MTP cannot be accessed anymore. The maximum number of times the MTP can be written depends on the address:

- 5 times for the angular rate calibration coefficients (see Section 7 for more details)
- Only 1 time for all the other coefficients, including the temperature sensor calibration coefficients.

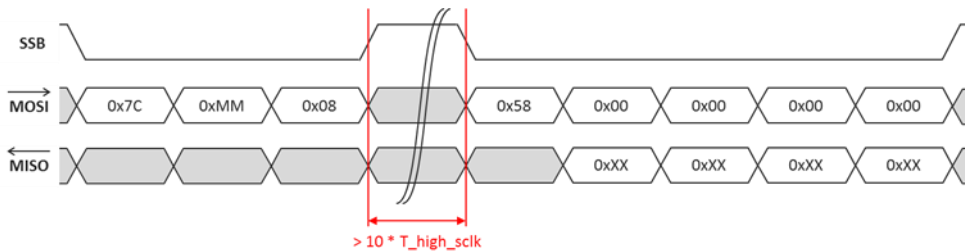

Figure 25 : Sequence of instructions to READ address 0xMM of the MTP

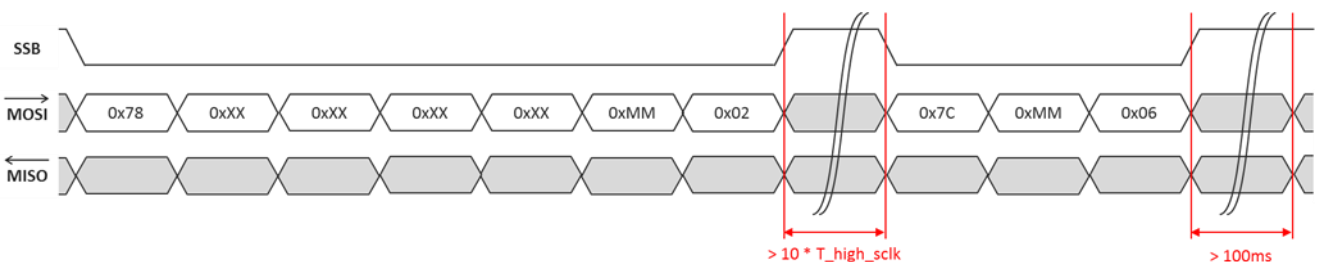

Figure 26: Sequence of instructions to WRITE data '0xXXXXXXX' to address '0xMM' of the MTP

### 6.5.3. Useful Sensor Parameters

The instructions given in Sections 6.5.1 and 6.5.2 can be used to read and/or to modify the sensor's useful parameters given in Table 8 below.

Parameter	Address M (System Register & MTP)	Bits	Encoding	Meaning
<b>Sensor Identification</b>				
UID	0x03	[31:0]	Tronics reserved	Sensor 'Unique Identification' number
<b>Temperature output compensation</b>				
TOUT_SEL	0x04	3 *	0 ** 1	Disable the calibrated temperature output Enable the calibrated temperature output
O	0x04	[31:18] *	0x0000 ** See section 8	Offset calibration of temperature sensor
G	0x04	[17:4] *	0x0800 ** See section 8	Gain calibration of temperature sensor
<b>Angular rate output compensation</b>				
GOUT_SEL	0x3D	31 *	0 1 **	Disable the calibrated angular rate output Enable the calibrated angular rate output
MTPSLOTNB	0x3D	[12:8] *	0b00000 0b00001 ** 0b00011 0b00111 0b01111 0b11111	Unprogrammed part Programmed once, 4 slots remaining Programmed twice, 3 slots remaining Programmed 3 times, 2 slots remaining Programmed 4 times, 1 slot remaining Programmed 5 times, no slot remaining
SF4	0x48	[18:0] *	See Table 9	Scale Factor 4th order coefficient (calibrated angular rate)
SF3	0x46	[19:0] *	See Table 9	Scale Factor 3rd order coefficient (calibrated angular rate)
SF2	0x44	[20:0] *	See Table 9	Scale Factor 2nd order coefficient (calibrated angular rate)
SF1	0x42	[29:0] *	See Table 9	Scale Factor 1st order coefficient (calibrated angular rate)
SF0	0x3F	[30:0] *	See Table 9	Scale Factor constant coefficient (calibrated angular rate)
B4	0x47	[18:0] *	See Table 9	Bias 4th order coefficient (calibrated angular rate)
B3	0x45	[19:0] *	See Table 9	Bias 3rd order coefficient (calibrated angular rate)
B2	0x43	[19:0] *	See Table 9	Bias 2nd order coefficient (calibrated angular rate)
B1	0x41	[29:0] *	See Table 9	Bias 1st order coefficient (calibrated angular rate)
B0	0x3E	[23:0] *	See Table 9	Bias constant coefficient (calibrated angular rate)
TMID	0x40	[19:0] *	See Table 9	Mid-temperature calibration point

**Table 8: Useful parameters information**

Notes:

\* The other bits at those addresses shall remain unchanged. Please make sure that you write them without modification!

\*\* Default Value



## 7. Angular rate calibration procedure

### 7.1. Algorithm overview

After filtering, the raw angular rate sensor output is temperature compensated based on the on-chip temperature sensor output and the stored temperature compensation parameters.

#### 7.1.1. Angular rate output calibration model

The formula below models the link between raw and compensated angular rate outputs:

$$\text{RATE}[^{\circ}/\text{s}] = \frac{\text{RATE}_{\text{COMP}}[\text{LSB}]}{\text{SF}_{\text{setting}}[\text{LSB}/^{\circ}/\text{s}]} = \frac{\text{RATE}_{\text{RAW}}[\text{LSB}] - \text{BIAS}[\text{LSB}]}{\text{SF}[\text{LSB}/^{\circ}/\text{s}]}$$

where:

- RATE is the angular rate output converted in °/s;
- RATE<sub>COMP</sub> is the calibrated angular rate output;
- SF<sub>setting</sub> is the constant conversion factor from LSB to °/s for the calibrated angular rate output. Default value for this parameter is SF<sub>setting</sub> = 10 000;
- RATE<sub>RAW</sub> is the raw data angular rate output;
- **BIAS** is a polynomial (4<sup>th</sup> degree) temperature-varying coefficient to model the sensor's bias temperature variations;
- **SF** is a polynomial (4<sup>th</sup> degree) temperature-varying coefficient to model the sensor's Scale Factor temperature variations.

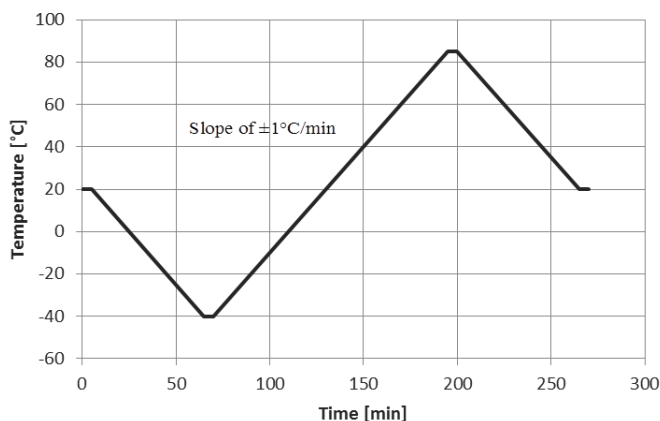

Figure 27: Recommended Temperature profile for calibration

<sup>1</sup> Temperature profile can be adapted to be in line with customer applications.

<sup>2</sup> Rate applied can be adapted to be in line with customer applications.

#### 7.1.2. Recommended procedure

1. Set GOUT\_SEL to 0 in the System Registers (disable the calibration)
2. Place the sensor on a rate table in a thermal chamber and implement temperature profile according to Figure 27<sup>1</sup>
3. Perform continuous acquisition of the angular rate output with the following pattern:
  - Rest position (0°/s input) to evaluate the BIAS parameter
  - + 300°/s input then -300°/s input to evaluate the SF parameter<sup>2</sup>
4. Calculate the coefficients of BIAS and SF polynomials:

$$\text{BIAS} = \sum_{i=0}^4 b_i (T_{\text{RAW}} - T_{\text{MID}})^i$$

$$\text{SF} = \sum_{i=0}^4 sf_i (T_{\text{RAW}} - T_{\text{MID}})^i$$

where

- T<sub>RAW</sub> is the raw output of the temperature sensor **multiplied by 64**;
  - T<sub>MID</sub> is the mid-value of T<sub>RAW</sub>;
  - b<sub>0</sub> to b<sub>4</sub> are the 5 coefficients of BIAS polynomial;
  - sf<sub>0</sub> to sf<sub>4</sub> are the 5 coefficients of SF polynomial.
5. Convert T<sub>MID</sub>, b<sub>i</sub> and sf<sub>i</sub> parameters to their binary values according to Table 9 below:

Parameter	Value (decimal)	Format
SF4	sf <sub>4</sub> · 2 <sup>92</sup> / SF <sub>setting</sub>	signed 2's comp
SF3	sf <sub>3</sub> · 2 <sup>77</sup> / SF <sub>setting</sub>	signed 2's comp
SF2	sf <sub>2</sub> · 2 <sup>55</sup> / SF <sub>setting</sub>	signed 2's comp
SF1	sf <sub>1</sub> · 2 <sup>46</sup> / SF <sub>setting</sub>	signed 2's comp
SF0	sf <sub>0</sub> · 2 <sup>27</sup> / SF <sub>setting</sub>	signed 2's comp
B4	b <sub>4</sub> · 2 <sup>73</sup>	signed 2's comp
B3	b <sub>3</sub> · 2 <sup>53</sup>	signed 2's comp
B2	b <sub>2</sub> · 2 <sup>32</sup>	signed 2's comp
B1	b <sub>1</sub> · 2 <sup>20</sup>	signed 2's comp
B0	b <sub>0</sub>	signed 2's comp
TMID	T <sub>MID</sub>	unsigned

Table 9: Angular rate calibration parameters



## 7.2. Programming of the new coefficients

**IMPORTANT NOTE:** The following steps are **non-reversible**. The previous values of the coefficients will not be accessible anymore. The temperature compensation coefficients can be re-programmed up to 4 additional times on the IC.

The programming procedure consists in three major steps:

- Checking the available MTP slot status
- Programming the coefficients
- Updating the available MTP slot status

An overview of the procedure is given in Figure 28.

### 7.2.1. Checking the MTP slot status

The first step is to check the number of remaining MTP slots (MTPSLOTNB), in other words, checking how many times the chip has been programmed before.

The detailed information of MTPSLOTNB register content is given in Table 8. The sequence of instructions to read the register is given in Figure 25.

The MTP slot number (MTPSLOTNB) re-programming iteration is given in the following table:

Iteration	Correspondence	MTP number	
		Value	Binary
0	Unprogrammed part	0	00000
1	Programmed once	1*	00001
2	Programmed twice	3	00011
3	...	7	00111
4		15	01111
5	Cannot be further programmed	31	11111

Table 10 MTPSLOTNB iterations

\* Default value

### 7.2.2. Programming the coefficients

This step describes the procedure for programming the calculated coefficients (temperature compensation of angular rate output). The programming procedure is:

1. Write SF4 in the system register
2. Program SF4 in the MTP
3. Write SF3 in the system register
4. Program SF3 in the MTP
5. Write SF2 in the system register
6. Program SF2 in the MTP
7. Write SF1 in the system register
8. Program SF1 in the MTP
9. Write SF0 in the system register
10. Program SF0 in the MTP
11. Write B4 in the system register

12. Program B4 in the MTP
13. Write B3 in the system register
14. Program B3 in the MTP
15. Write B2 in the system register
16. Program B2 in the MTP
17. Write B1 in the system register
18. Program B1 in the MTP
19. Write B0 in the system register
20. Program B0 in the MTP
21. Write TMID in the system register
22. Program TMID

The detailed SPI commands are given in section 6.5. The detailed information about each coefficient is given in Table 8.

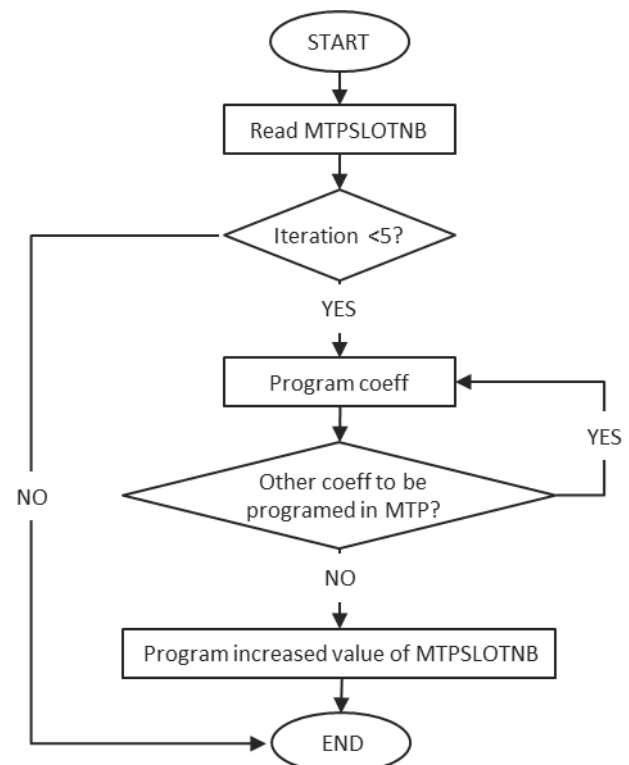

Figure 28 Procedure to program new calibration parameters

### 7.2.3. Updating MTP slot status

This section describes the procedure for programming the updated status of the MTP slots.

**If this step is not performed properly, the new compensation coefficients will not be effective.**

1. Read the MTPSLOTNB as described in section 6.5.2
2. Increment MTPSLOTNB according Table 10.
3. Write the updated MTPSLOTNB in the system register.
4. Program the updated MTPSLOTNB in the MTP.
5. After a reset, the new coefficients will be available.

### 7.3. Switch to uncompensated data output

To optimize the thermal compensation of the angular rate output, it is possible to disable the on-chip compensation and use the uncompensated (raw) output to perform an external thermal compensation.

**IMPORTANT NOTE:** This step is **non-reversible**. The previous values of the coefficients will not be accessible anymore.

To switch the angular rate output to uncompensated data, the procedure is exactly the same as describe in section 7.2, but the coefficients given in Table 9 must be replaced by the coefficients given below in Table 11.

Parameter	Value (hexadecimal)
SF4	0x0
SF3	0x0
SF2	0x0
SF1	0x0
SF0	0x0800 0000
B4	0x0
B3	0x0
B2	0x0
B1	0x0
B0	0x0
TMID	0x0

**Table 11 Angular rate compensation coefficients to obtain raw data**

## 8. Temperature Sensor Calibration Procedure

The temperature output of GYPRO3300 sensors is *not* factory-calibrated, since only the relative temperature output is needed to perform temperature compensation of the angular rate output. However, it is possible to perform a first-order polynomial calibration of the temperature sensor, in order to output the absolute temperature information.

This section shows how to get and store temperature calibration parameters for the temperature output.

### 8.1. Temperature sensor calibration model

The formula below models the link between raw and calibrated temperature output:

$$T[^\circ\text{C}] = \frac{T_{\text{COMP}}[\text{LSB}]}{\text{GAIN}_{\text{setting}}[\text{LSB}/^\circ\text{C}]} = \frac{\text{GAIN} \cdot T_{\text{RAW}}[\text{LSB}] - \text{OFFSET}[\text{LSB}]}{\text{GAIN}_{\text{setting}}[\text{LSB}/^\circ\text{C}]}$$

where:

- T is the output temperature converted in °C;
- T<sub>COMP</sub> is the calibrated temperature output;
- GAIN<sub>setting</sub> is the constant conversion factor from LSB to °C for the calibrated temperature output. This gain is set to 20LSB/°C to provide an output resolution of 0,1°C;
- T<sub>RAW</sub> is the raw data temperature output;
- **OFFSET** is a constant coefficient to tune the offset;
- **GAIN** is a constant coefficient to tune gain.

The **OFFSET** and **GAIN** parameters will be computed and written in the ASIC as per the following calibration procedure.

### 8.2. Recommended Procedure

1. Check that TOUT\_SEL = 0. If not, set it to 0 in the System Registers.
2. Measure the temperature output with at least 2 temperature points T<sub>1</sub> and T<sub>2</sub>.

3. Calculate the GAIN and OFFSET coefficients according to formula above

$$\text{GAIN} = \text{GAIN}_{\text{setting}} \cdot \frac{T1_{\text{ABS}}[^\circ\text{C}] - T2_{\text{ABS}}[^\circ\text{C}]}{T1_{\text{RAW}}[\text{LSB}] - T2_{\text{RAW}}[\text{LSB}]}$$

$$\text{OFFSET} = \text{GAIN}_{\text{setting}} \cdot T1_{\text{ABS}}[^\circ\text{C}] - \text{GAIN} \cdot T1_{\text{RAW}}[\text{LSB}]$$

where:

- T<sub>1ABS</sub> is the absolute temperature of T<sub>1</sub> in °C;
  - T<sub>2ABS</sub> is the absolute temperature of T<sub>2</sub> in °C;
  - T<sub>1RAW</sub> is the raw output temperature of T<sub>1</sub> in LSB;
  - T<sub>2RAW</sub> is the raw output temperature of T<sub>2</sub> in LSB;
4. Convert GAIN and OFFSET to their binary values according to Table 12 below:

Parameter	Value (decimal)	Format
G	GAIN · 2 <sup>11</sup>	Unsigned
O	OFFSET	Unsigned

**Table 12: Temperature calibration parameters**

5. [Optional step: Write GAIN and OFFSET into the System Registers and repeat step 2. to check the accuracy of the new calibration.]
6. Write GAIN and OFFSET into the MTP according to instructions of Section 6.5.2. Meanwhile, set TOUT\_SEL to 1 during this step, so that the new calibration parameters are effective after a RESET.

### 9. Device Identification / Ordering information

#### 9.1. Device identification

GYPRO3300 tracking information is accessible on the label, as shown in the next figure.

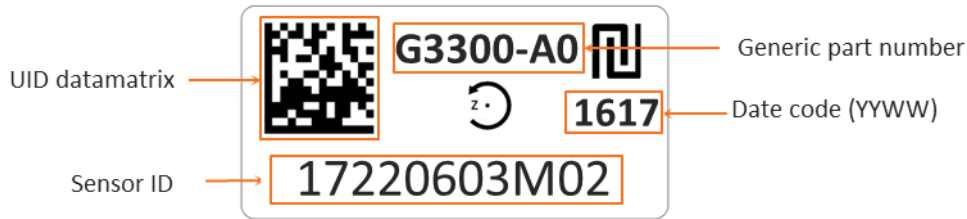

Figure 29: GYPRO3300 label.

#### 9.2. Ordering information

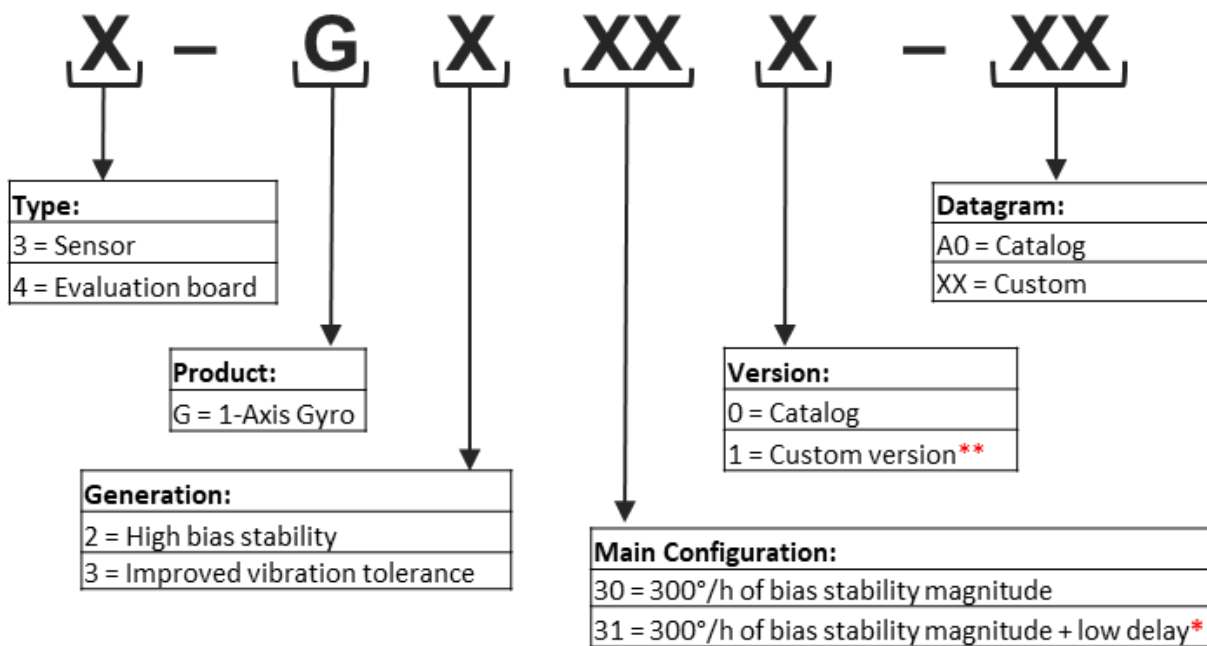

Figure 30 Ordering information

\*For second 2<sup>nd</sup> generation only

Product	Ordering code
GYPRO2300	3-G2300-A0
GYPRO2300LD	3-G2310-A0
GYPRO3300	3-G3300-A0
GYPRO2300-EVB2	4-G2300-A0
GYPRO2300LD-EVB2	4-G2310-A0
GYPRO3300-EVB2	4-G3300-A0

## 10. Internal construction and Theory of Operation

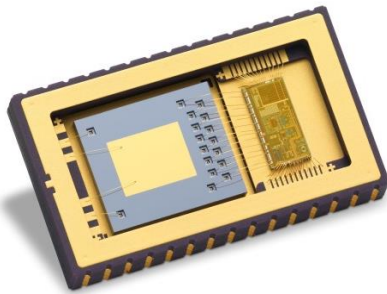

Figure 31 : Inner view of the package, showing the MEMS and IC

GYPRO series is using the dominant architecture for high performance MEMS gyro, namely the “Tuning fork or dual mass” design.

In details, each sensor consists in a MEMS transducer and an integrated circuit (IC) packaged in a 30-pins Ceramic Leadless Chip Carrier Package.

The sensing element (MEMS die), which is located on the left part of the Figure 31, is manufactured using Tronics’ wafer-level packaging technology based on micro-machined thick single crystal silicon. The MEMS consists of two coupled sub-structures subjected to linear anti-phase vibrations. The structures are vacuumed at the wafer-level providing high Q-factor in the drive mode. The drive system is decoupled from the sense system in order to reduce feedback from sense motion to drive electrodes. The drive anti phase vibration is sustained by electrostatic comb drives. The sense anti phase vibration resulting from Coriolis forces is counter balanced by electrostatic forces. Differential detection and actuation are used for both drive and sense systems and for each sub-structure, keeping two identical structures for efficient common mode rejection.

The integrated circuit (IC), which is located on the right part of the Figure 31, is designed to interface the MEMS sensing element. It includes ultra-low noise capacitive to voltage converters (C2V) followed by high resolution voltage digitization (ADC) for both drive and sense paths. Excitation voltage required for capacitance sensing circuits is generated on the common electrode node. 1-bit force feedbacks (DAC) are used for both drive and sense system actuation.

The choice for the implemented close-loop architecture based on a Sigma-Delta principle is particularly well adapted as it brings the following key advantages:

- 1) Sigma-Delta is well suited for low-frequency signals. Noise shaping principle rejects quantization noise in high frequency bands.
- 2) Simplicity of hardware implementation. Oversampling concept allows significant design relaxation of

the analog detection chain signal resolution. Additionally the voltage reference used for actuation force feedback is also of simple implementation as it is a 1-bit D/A converter, thus simplifying its design.

- 3) Linearization of the electrostatic forces thanks to the Sigma-delta principle (through force averaging) furthermore reduces non-linearity overall and more importantly its even-order terms, which result in rectification error.

- 4) Sigma-Delta signal output is inherently a digital signal, thus suppressing the need for costly high resolution A/D converter.

The digital part implements digital drive and sense loops, demodulates, decimates and processes the gyro output based on the on-chip temperature sensor output. The system controller manages the interface between the SPI registers, the system register and the non-volatile memory (OTP). The non-volatile memory provides the gyro settings, in particular the coefficients for angular rate sensor temperature compensation. On power up, the gyro settings are transferred from the OTP to the system registers and output data are available in the SPI registers. The angular rate sensor output and the temperature sensor output are available in the SPI registers. The SPI registers are available through the SPI interface (SSB, SCLK, MOSI, MISO). The self-test and the data ready are available respectively on the external pins ST and DRDY.













The “References” block generates the required biasing currents and voltages for all blocks as well as the low-noise reference voltage for critical blocks.

The “Power Management” block manages the power supply of the sensor from a single 5V supply between the VDD and GND pins. It includes a power on reset as well as an external reset pin (RSTB) to start or restart operation using default configuration. An enable pin (EN) with power-down capability is also available.

The sensor is powered with a single 5V DC power supply through pins VDD and GND. Although the sensor contains three separate VDD pins, the sensor is supplied by a single 5V voltage source. It is recommended to supply the three VDD pins in a star connection with appropriate decoupling capacitors. Regarding the sensor grounds, all the GND pins are internally shorted. The GND pins redundancy is used for multiple bonds in order to reduce the total ground inductance. It is therefore recommended to connect all the GND pins to the ground.

## 11. Available Tools and Resources

The following tools and resources are available on [website](#) or upon request.

Item	Description
<b>Documentation &amp; technical notes</b>	
	<b>GYPRO® product line - Flyer</b>
	<b>GYPRO® product – Technical note</b> External filtering for Gypro2300LD and Gypro3300
	<b>GYPRO® product – Technical note</b> GYPRO MTBF Methodology
<b>Mechanical tools</b>	
	<b>GYPRO3300 – 3D model</b>
<b>Evaluation kit</b>	
	<b>GYPRO3300-EVB2 – Evaluation board</b> Evaluation board for GYPRO3300, compatible with Arduino Yun rev2
	<b>GYPRO® Evaluation Board – User manual</b>
	<b>GYPRO® Evaluation Kit – Quick start guide</b>
	<b>GYPRO® Evaluation Tool – Software user manual</b>
	<b>GYPRO® Evaluation Tool – Tutorial</b> Installation and programming of the Evaluation kit
	<b>GYPRO® Evaluation Tool – Tutorial</b> Software
	<b>GYPRO® Evaluation Tool – Software</b>
	<b>GYPRO® Evaluation Tool – Arduino Firmware</b>



Компания «Life Electronics» занимается поставками электронных компонентов импортного и отечественного производства от производителей и со складов крупных дистрибьюторов Европы, Америки и Азии.

С конца 2013 года компания активно расширяет линейку поставок компонентов по направлению коаксиальный кабель, кварцевые генераторы и конденсаторы (керамические, пленочные, электролитические), за счёт заключения дистрибьюторских договоров

Мы предлагаем:

- Конкурентоспособные цены и скидки постоянным клиентам.
- Специальные условия для постоянных клиентов.
- Подбор аналогов.
- Поставку компонентов в любых объемах, удовлетворяющих вашим потребностям.
- Приемлемые сроки поставки, возможна ускоренная поставка.
- Доставку товара в любую точку России и стран СНГ.
- Комплексную поставку.
- Работу по проектам и поставку образцов.
- Формирование склада под заказчика.
- Сертификаты соответствия на поставляемую продукцию (по желанию клиента).
- Тестирование поставляемой продукции.
- Поставку компонентов, требующих военную и космическую приемку.
- Входной контроль качества.
- Наличие сертификата ISO.

В составе нашей компании организован Конструкторский отдел, призванный помогать разработчикам, и инженерам.

Конструкторский отдел помогает осуществить:

- Регистрацию проекта у производителя компонентов.
- Техническую поддержку проекта.
- Защиту от снятия компонента с производства.
- Оценку стоимости проекта по компонентам.
- Изготовление тестовой платы монтаж и пусконаладочные работы.



Тел: +7 (812) 336 43 04 (многоканальный)

Email: [org@lifeelectronics.ru](mailto:org@lifeelectronics.ru)