



Surround Audio Processor for Mobile Applications

■ GENERAL DESCRIPTION

The **NJM2705** is the surround audio processor for mobile applications.

It regenerates the 3D surround sound with extremely narrow space two speakers (2SP mode), headphone surround with normal headphone (HP mode) and reverberation sound with only one speaker (1SP mode).

It includes mode control switches for surround function and standby function and realizes low consumption power design by standby function.

It is suitable for PDA and portable game.

■ PACKAGE OUTLINE

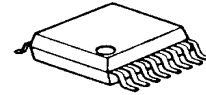

NJM2705V

■ FEATURES

- Operating Voltage 1.8 to 6V
- Operating Current 0.7mA typ. at Active mode
1μA max. at Standby mode
- Low Output Noise 10μVrms typ
(2SP/HP/1SP mode, VR : max.)
- Variable Surround Effect by external resistor
(Adjustable for speaker and headphone independently.)
- Standby Function
- Internal Mode Control Switch
- Bipolar Technology
- Package Outline SSOP16

■ BLOCK DIAGRAM

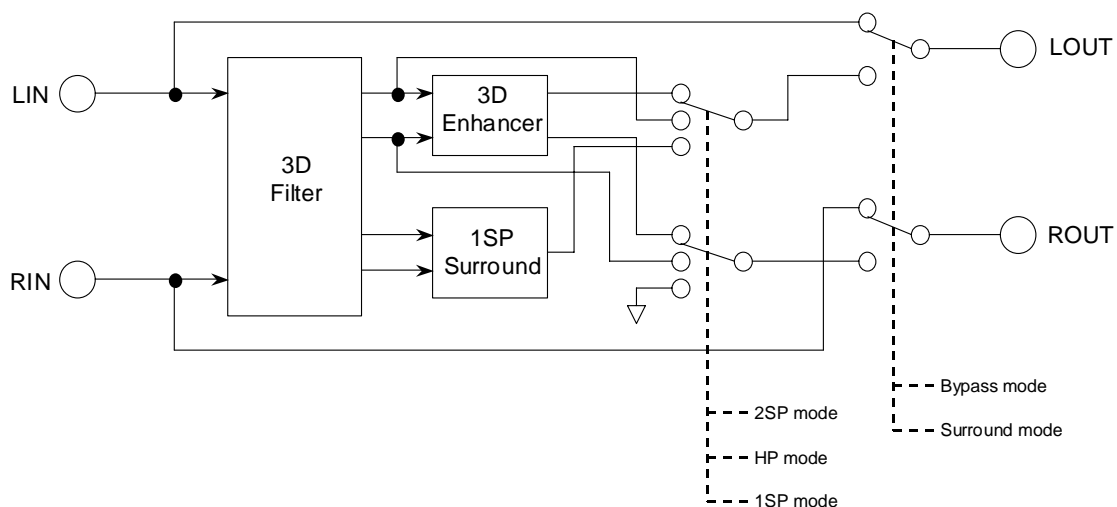

NJM2705

■ PIN CONFIGURATION

SSOP16 (Top View)

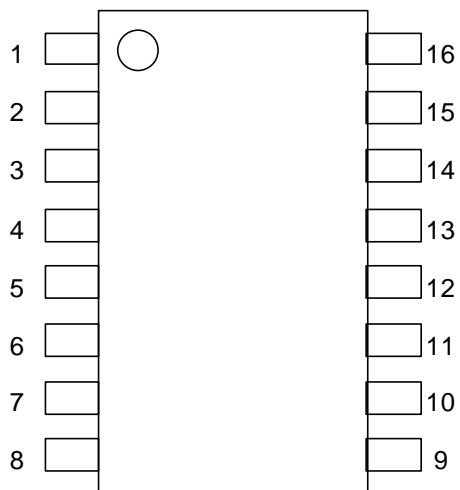

- | | |
|----------|-----------|
| 1. NFHPR | 9. V+ |
| 2. NFSPR | 10. STBY |
| 3. ROUT | 11. SW1 |
| 4. LOUT | 12. SW2 |
| 5. RIN | 13. PS |
| 6. LIN | 14. LMON |
| 7. VREF | 15. NFHPL |
| 8. GND | 16. NFSPL |

■ABSOLUTE MAXIMUM RATING (Ta=25°C)

PARAMETER	SYMBOL	RATINGS	UNIT
Supply Voltage	V ⁺	7	V
Power Dissipation	P _D	300	mW
Operating Temperature Range	T _{opr}	-20 to +75	°C
Storage Temperature Range	T _{stg}	-40 to +125	°C

■OPERATING VOLTAGE

PARAMETER	SYMBOL	TEST CONDITION	MIN	TYP	MAX	UNIT
Operating Voltage	V ⁺	-	1.8	3.0	6.0	V

■ELECTRICAL CHARACTERISTICS (V⁺=3V, Ta=25°C unless otherwise specified)

PARAMETER	SYMBOL	TEST CONDITION	TEST CONDITION						MIN	TYP	MAX	UNIT
			INPUT		OUT PUT	MODE	SP VR	HP VR				
			L	R								
Operating Current	I _{cc}	No Signal	0	0	-	Active			-	450	700	μA
			0	0	-	Standby			-	0.1	1.0	
Reference Voltage	V _{ref}	No Signal	0	0	-	-			1.0	1.15	1.3	V

●AC CHARACTERISTICS

(V⁺=3V, Ta=25°C, V_{IN}=-20dBV(100mVrms), f=1kHz, R_L=10kΩ, unless otherwise specified)

PARAMETER	SYMBOL	TEST CONDITION	TEST CONDITION						MIN	TYP	MAX	UNIT
			INPUT		OUT PUT	MODE	SP VR	HP VR				
			L	R								
Maximum Input Voltage	V _{IM1}	f=1kHz THD=1%	V _{IN} 0	0 V _{IN}	L R	Bypass	-	-	-	-2.0 (790)	-	dBV (mVrms)
	V _{IM2}	f=100Hz THD=1%	V _{IN} 0	0 V _{IN}	L R	2SP	MAX	-	-	-16.0 (160)	-	
	V _{IM3}	f=100Hz THD=1%	V _{IN} 0	0 V _{IN}	L R	HP	-	MAX	-	-16.0 (160)	-	
	V _{IM4}	f=100Hz THD=1%	V _{IN}	0	L	1SP	MAX	-	-	-16.0 (160)	-	
	V _{IM5}	f=100Hz THD=1%	0	V _{IN}	L	1SP	MAX	-	-	-14.5 (190)	-	
	V _{IM6}	V ⁺ =1.8V, f=1kHz THD=1%	V _{IN} 0	0 V _{IN}	L R	Bypass	-	-	-10.5 (300)	-8.5 (380)	-	
	V _{IM7}	V ⁺ =1.8V, f=100Hz THD=1%	V _{IN} 0	0 V _{IN}	L R	2SP	MAX	-	-24.5 (60)	-22.5 (75)	-	
	V _{IM8}	V ⁺ =1.8V, f=100Hz THD=1%	V _{IN} 0	0 V _{IN}	L R	HP	-	MAX	-24.5 (60)	-22.5 (75)	-	
	V _{IM9}	V ⁺ =1.8V, f=100Hz THD=1%	V _{IN}	0	L	1SP	MAX	-	-24.5 (60)	-22.5 (75)	-	
	V _{IM10}	V ⁺ =1.8V, f=100Hz THD=1%	0	V _{IN}	L	1SP	MAX	-	-23.0 (70)	-21.0 (90)	-	
Output Noise	V _{NO1}	R _g =∞ A-Weighted	0	0	L R	Bypass	-	-	-	-112 (25)	-106 (50)	dBV (μVrms)
	V _{NO2}	R _g =∞ A-Weighted	0	0	L R	1SP	MAX	-	-	-100 (10)	-94 (20)	
	V _{NO3}	R _g =∞ A-Weighted	0	0	L R	HP	-	MAX	-	-100 (10)	-94 (20)	
	V _{NO4}	R _g =∞ A-Weighted	0	0	L	1SP	MAX	-	-	-100 (10)	-94 (20)	

NJM2705

● AC CHARACTERISTICS

($V^+=3V$, $T_a=25^\circ C$, $V_{IN}=-20dBV(100mVrms)$, $f=1kHz$, $R_L=10k\Omega$, unless otherwise specified)

PARAMETER	SYMBOL	TEST CONDITION							MIN	TYP	MAX	UNIT
		INPUT		OUT PUT	MODE	SP VR	HP VR					
		L	R									
Total Harmonic Distortion	THD1	f=1kHz	V_{IN} 0	0 V_{IN}	L R	Bypass	-	-	-	0.02	0.05	%
	THD2	f=1kHz	V_{IN} 0	0 V_{IN}	L R	2SP	MAX	-	-	0.1	0.5	
	THD3	f=1kHz	V_{IN} 0	0 V_{IN}	L R	HP	-	MAX	-	0.1	0.5	
	THD4	f=1kHz	V_{IN} 0	0 V_{IN}	L R	1SP	MAX	-	-	0.1	0.5	
BYPASS Gain	G_{VBYP}	f=1kHz	V_{IN} 0	0 V_{IN}	L R	Bypass	-	-	-1.0	0.0	1.0	dB
Surround Gain	G_{VSUR1}	f=100Hz	V_{IN} 0	0 V_{IN}	L R	2SP	MAX	-	12.5	14.5	16.5	dB
	G_{VSUR2}	f=100Hz	V_{IN} 0	0 V_{IN}	L R	2SP	MIN	-	0.5	2.5	4.5	
	G_{VSUR3}	f=100Hz	V_{IN} 0	0 V_{IN}	L R	HP	-	MAX	12.5	14.5	16.5	
	G_{VSUR4}	f=100Hz	V_{IN} 0	0 V_{IN}	L R	HP	-	MIN	0.5	2.5	4.5	
	G_{VSUR5}	f=100Hz	V_{IN}	0	L	1SP	MAX	-	6.5	8.5	10.5	
	G_{VSUR6}	f=100Hz	0	V_{IN}	L	1SP	MAX	-	2.0	4.0	6.0	
	G_{VSUR7}	f=100Hz	V_{IN}	0	L	1SP	MIN	-	-5.5	-3.5	-1.5	
	G_{VSUR8}	f=100Hz	0	V_{IN}	L	1SP	MIN	-	-12.0	-10.0	-8.0	

● CONTROL CHARACTERISTICS ($V^+=3V$, $T_a=25^\circ C$ unless otherwise specified)

PARAMETER	SYMBOL	TEST CONDITION	MIN	TYP	MAX	UNIT
MODE Select Control Voltage	V_{MODE}	V_{IN} =High Level	1.2	-	V^+	V
		V_{IN} =Low Level	0.0	-	0.3	

■ SWITCH FUNCTION

SURROUND FUNCTION SW

MODE	SW1	SW2	NOTES
Bypass	L, OPEN	L, OPEN	Input Through
2SP mode	L, OPEN	H	Surround mode for narrow space two speakers
HP mode	H	L, OPEN	Surround mode for Headphone
1SP mode	H	H	Surround mode for monaural speaker (Surround signal from LOUT)

STANDBY SW

MODE	STBY	NOTES
Standby	L, open	IC is non-active
Active	H	IC is active

TERMINAL DESCRIPTION

PIN No.	SYMBOL	FUNCTION	EQUIVALENT CIRCUIT	Voltage
5 6	LIN RIN	Lch Input Rch Input		1.15V
4 3 14	LOUT ROUT LMON	Lch Output Rch Output Filter terminal		1.15V
2 1 16 15	NFSPR NFHPR NFSPL NFHPL	Filter terminal Filter terminal Filter terminal Filter terminal		1.15V
13	PS	Filter terminal		1.15V

NJM2705

TERMINAL DESCRIPTION

PIN No.	SYMBOL	FUNCTION	EQUIVALENT CIRCUIT	Voltage
12 11	SW2 SW1	Mode control switch Mode control switch		0V
10	STBY	Standby switch		0V
9	V+	Power Supply	—	V+
8	GND	GND	—	0V
7	VREF	Reference voltage		1.15V

APPLICATION CIRCUIT

1) 2SP mode, HP mode

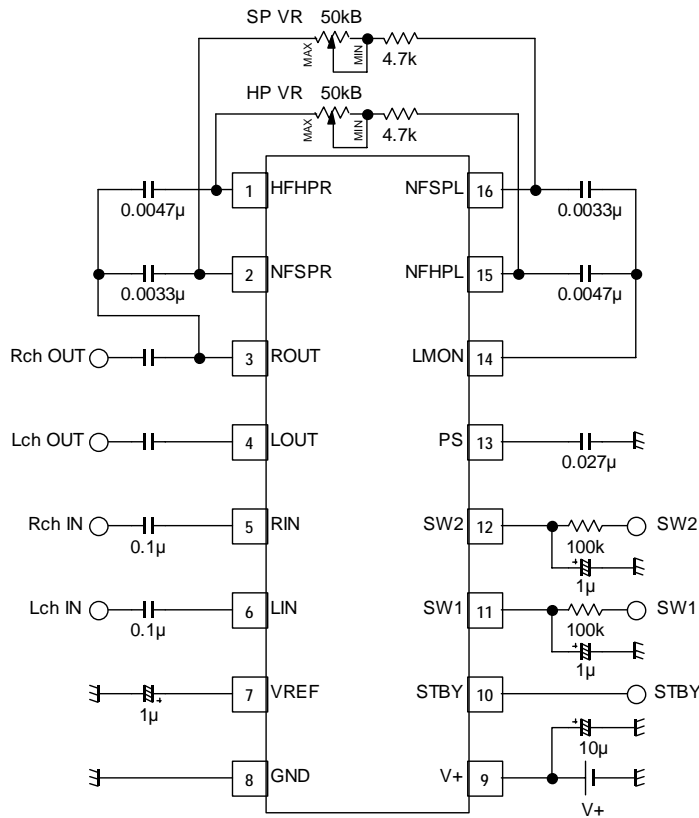

2) 1SP mode, HP mode

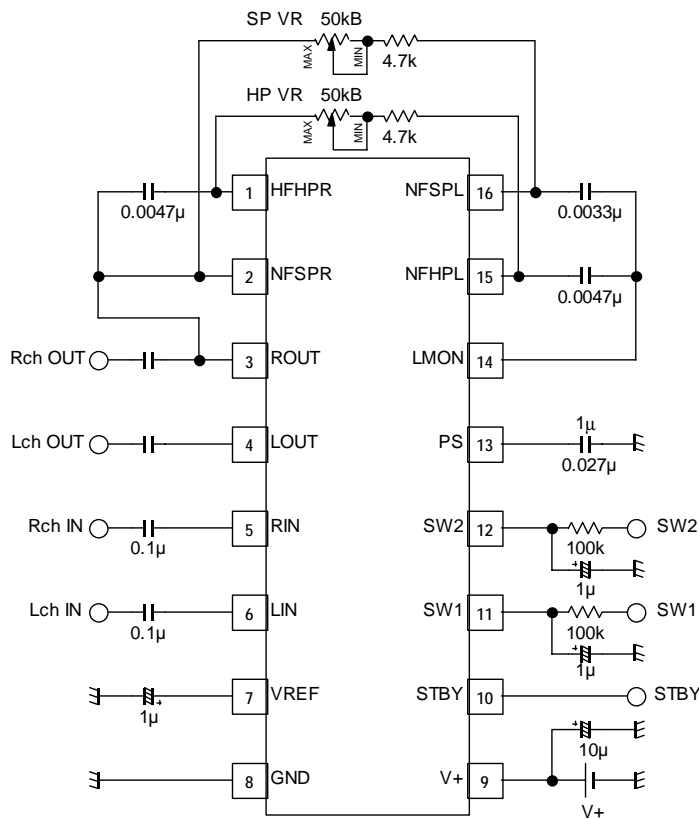

Surround signal is outputted from LOUT terminal at 1SP mode.

TYPICAL CHARACTERISTICS

Operating Current vs. Operating Voltage (STANDBY)

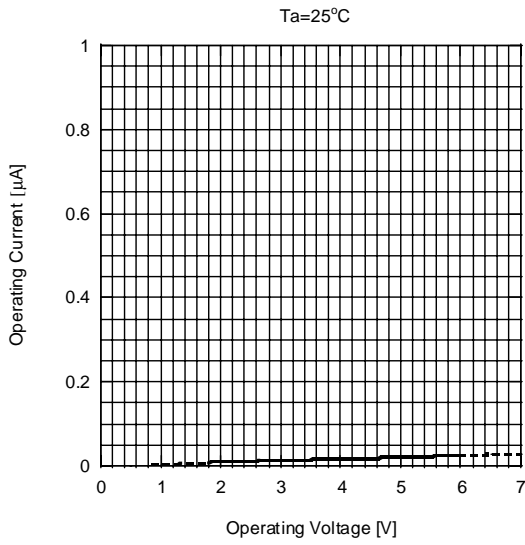

Operating Current vs. Temperature (STANDBY)

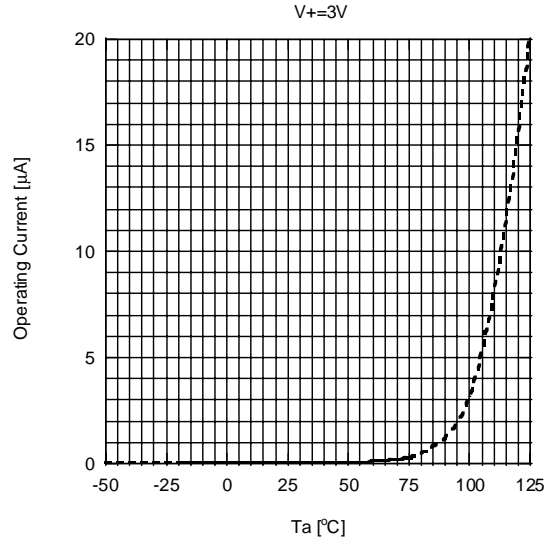

Operating Current vs. Operating Voltage (ACTIVE)

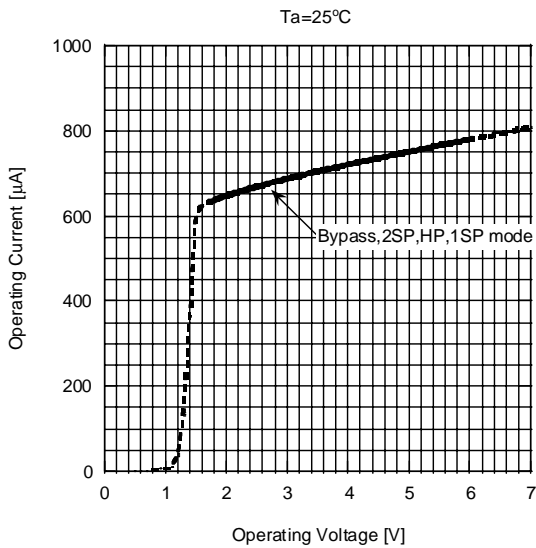

Operating Current vs. Temperature (ACTIVE)

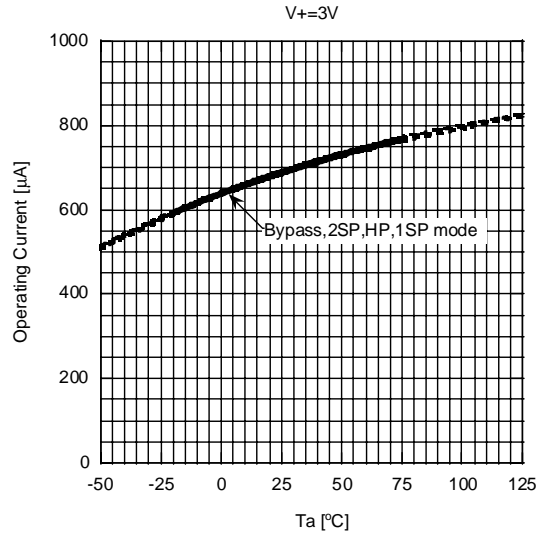

Reference Voltage vs. Operating Voltage

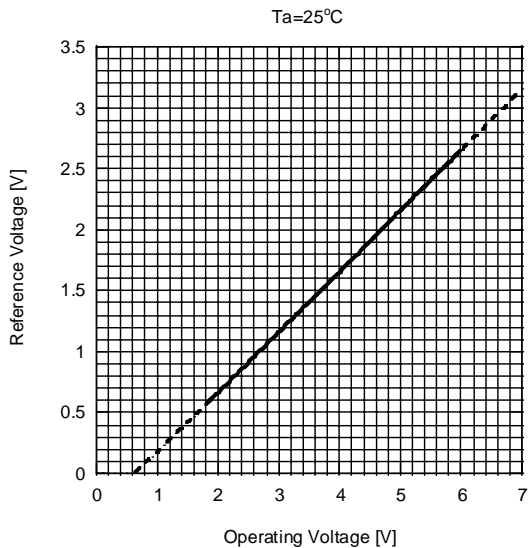

Reference Voltage vs. Temperature

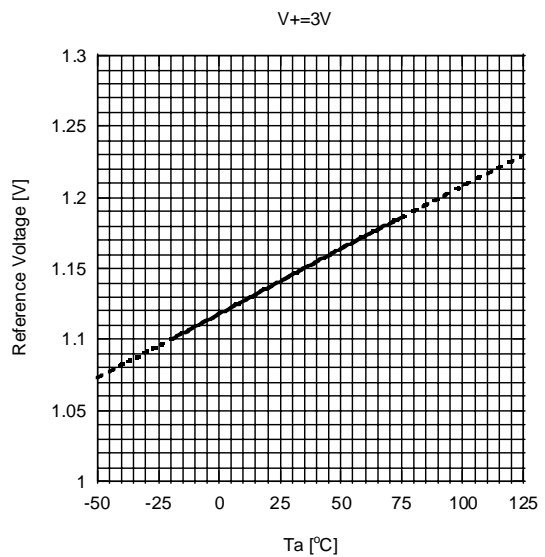

TYPICAL CHARACTERISTICS

Maximum Input Voltage vs. Operating Voltage (BYPASS)

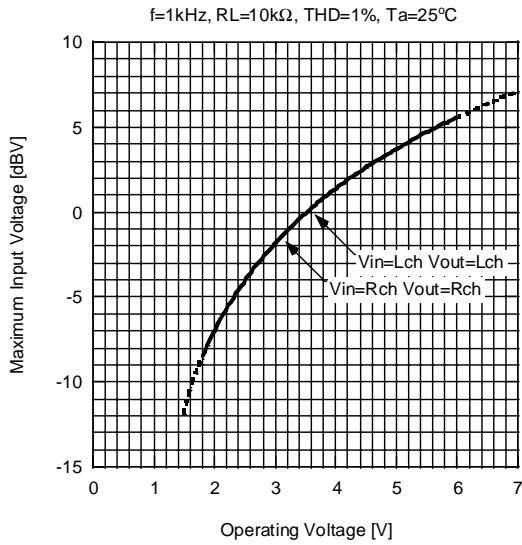

Maximum Input Voltage vs. Operating Voltage (2SP)

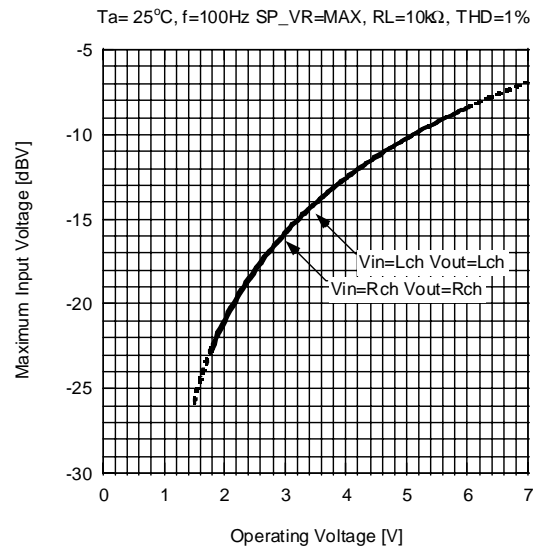

Maximum Input Voltage vs. Operating Voltage (HP)

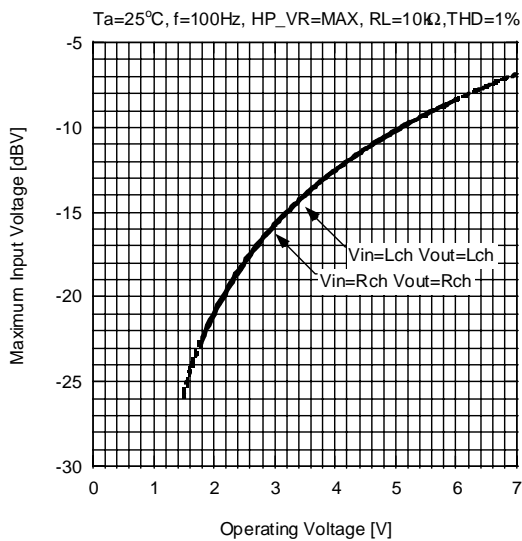

Maximum Input Voltage vs. Temperature (1SP)

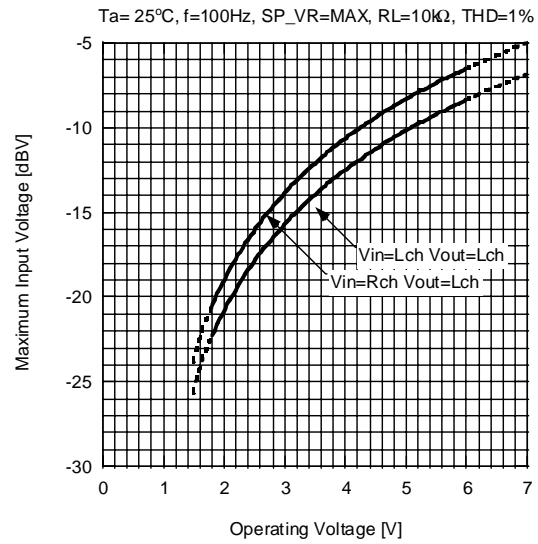

Maximum Input Voltage vs. Temperature (BYPASS)

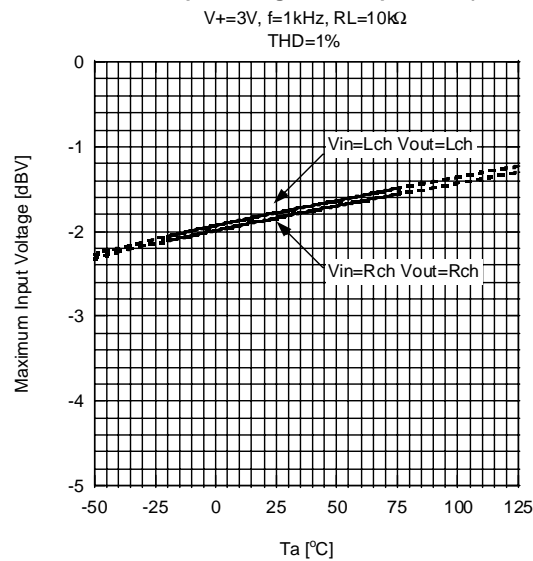

Maximum Input Voltage vs. Temperature (2SP)

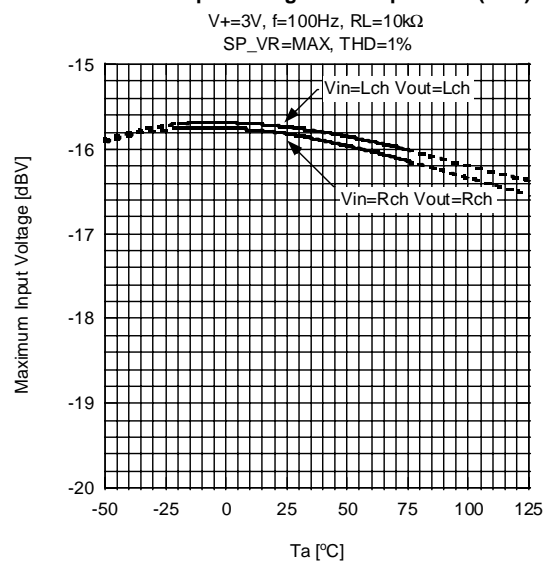

NJM2705

TYPICAL CHARACTERISTICS

Maximum Input Voltage vs. Temperature (HP)

V+=3V, f=100Hz, RL=10kΩ
HP_VR=MAX, THD=1%

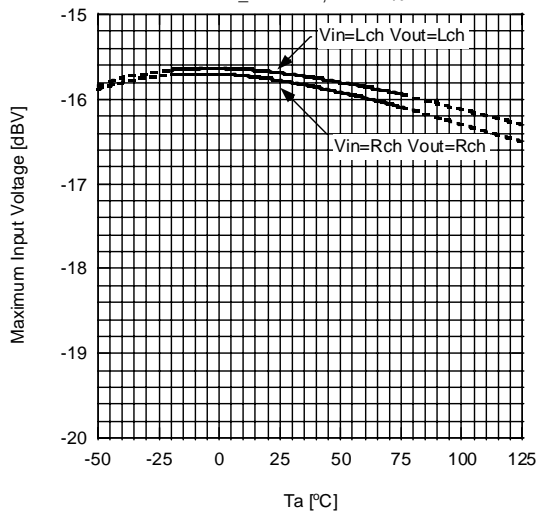

Maximum Input Voltage vs. Temperature (1SP)

V+=3V, f=100Hz, RL=10kΩ
SP_VR=MAX, THD=1%

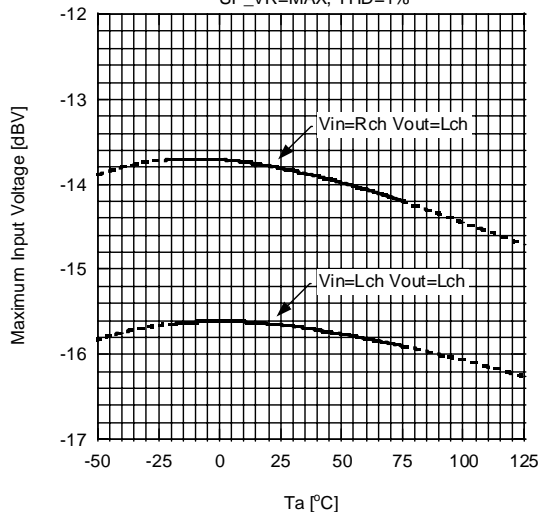

Output Noise Voltage vs. Temperature

V+=3V, Rg=0Ω, Vout=Lch
SP_VR=MAX, HP_VR=MAX, FILTER=A-Weighted

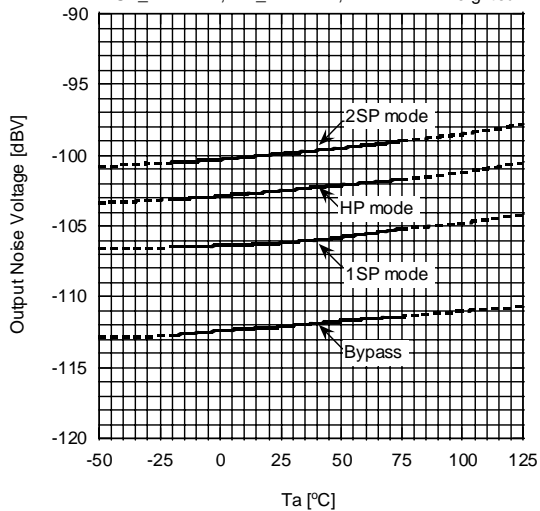

Output Noise Voltage vs. Temperature

V+=3V, Rg=0Ω, Vout=Rch
SP_VR=MAX, HP_VR=MAX, FILTER=A-Weighted

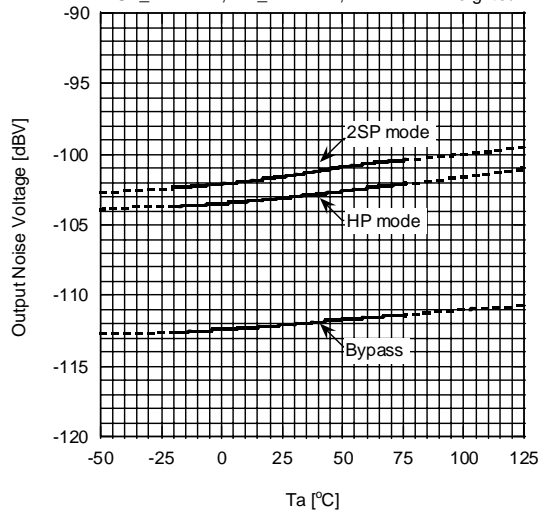

Total Harmonic Distortion vs. Input Voltage (BYPASS)

V+=3V, Vin=Lch, f=1kHz, Vout=Lch
RL=10kΩ, BW=10Hz-80kHz

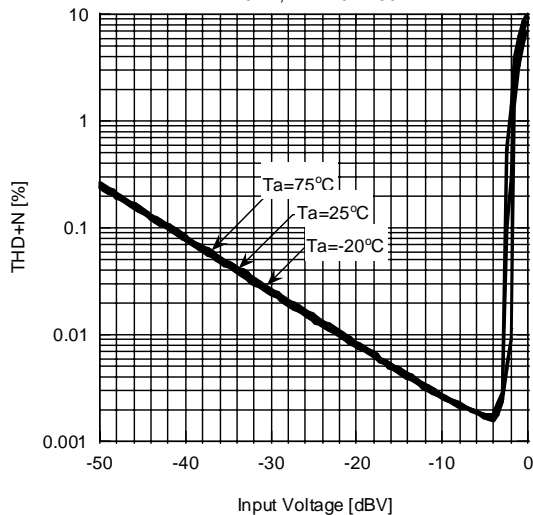

Total Harmonic Distortion vs. Input Voltage (2SP)

V+=3V, Vin=Lch, f=100Hz, Vout=Lch
RL=10kΩ, BW=10Hz-80kHz, SP_VR=MAX

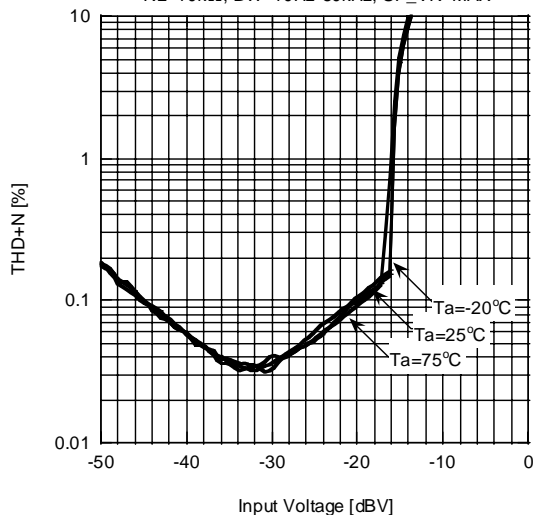

TYPICAL CHARACTERISTICS

Total Harmonic Distortion vs. Input Voltage (HP)

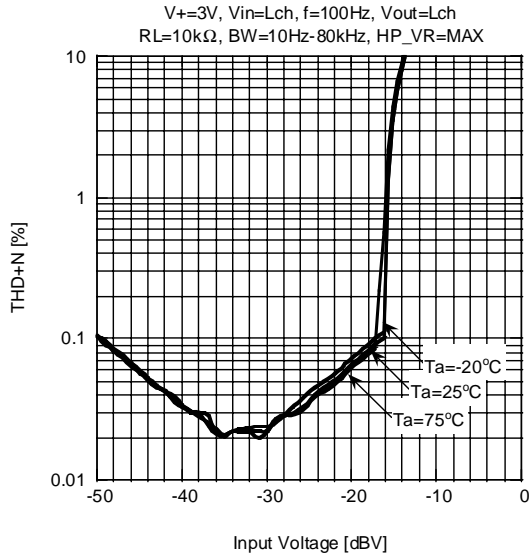

Total Harmonic Distortion vs. Input Voltage (1SP)

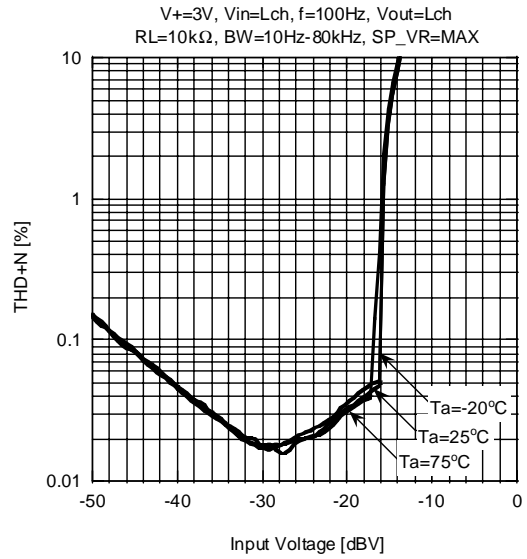

Frequency Response (BYPASS)

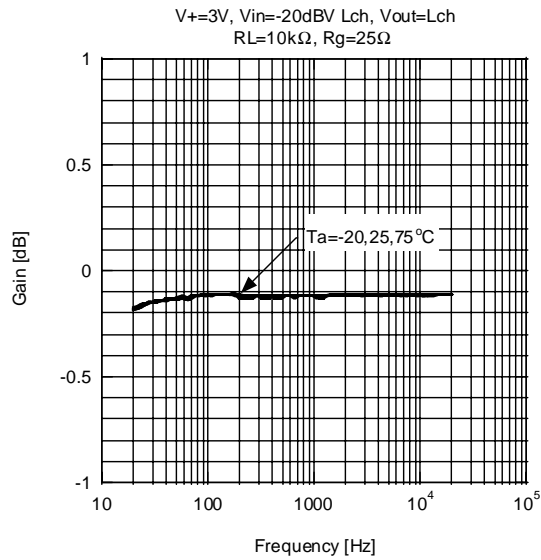

Frequency Response (2SP)

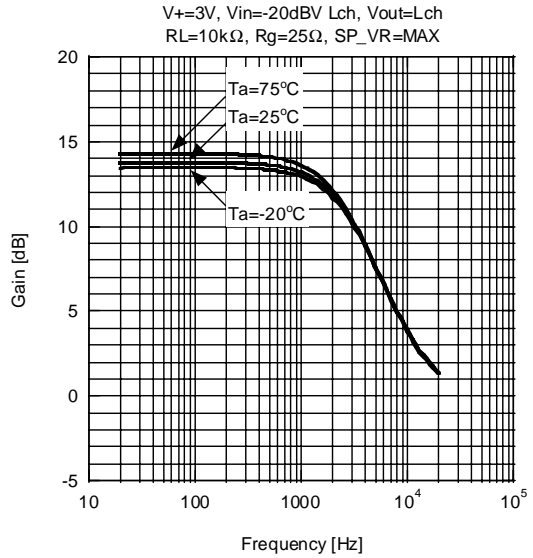

Frequency Response (2SP)

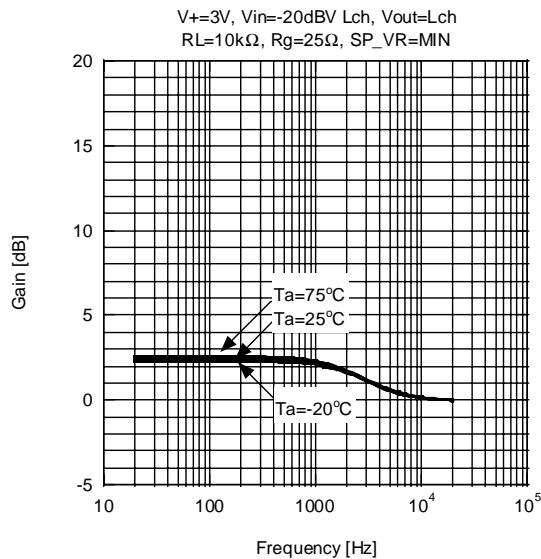

Phase vs. Frequency (2SP)

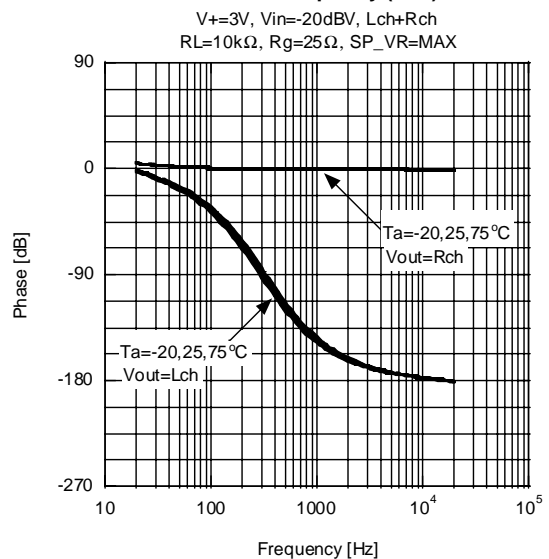

TYPICAL CHARACTERISTICS

Frequency Response (HP)

V+=3V, Vin=-20dBV Lch, Vout=Lch
RL=10kΩ, Rg=25Ω, HP_VR=MAX

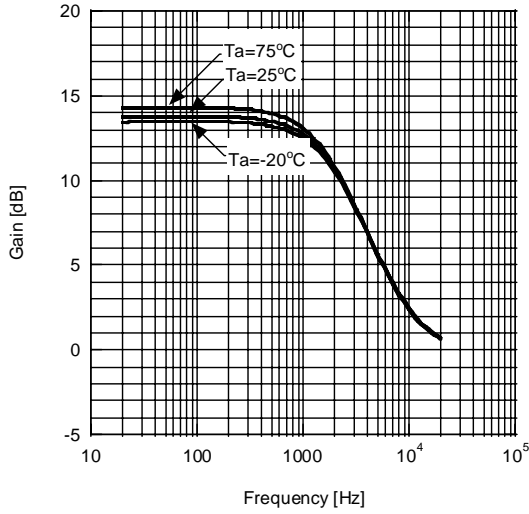

Frequency Response (HP)

V+=3V, Vin=-20dBV Lch, Vout=Lch
RL=10kΩ, Rg=25Ω, HP_VR=MIN

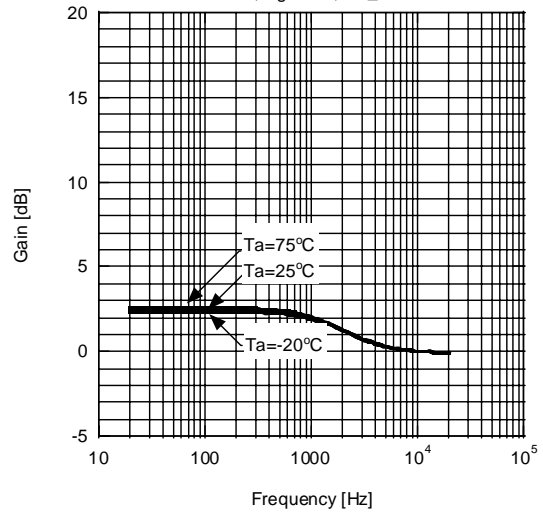

Frequency Response (1SP)

V+=3V, Vin=-20dBV, Vout=Lch
RL=10kΩ, Rg=25Ω, SP_VR=MAX

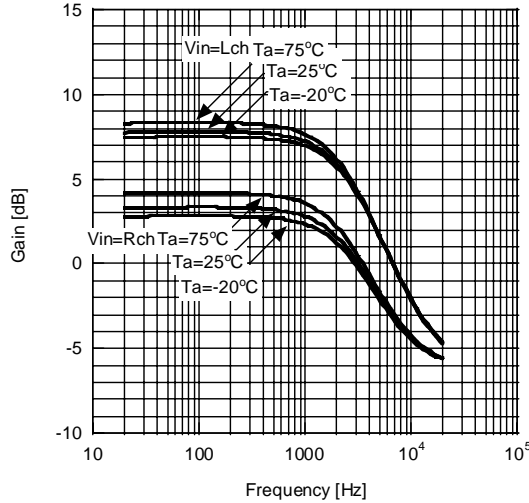

Frequency Response (1SP)

V+=3V, Vin=-20dBV, Vout=Lch
RL=10kΩ, Rg=25Ω, VR=MIN

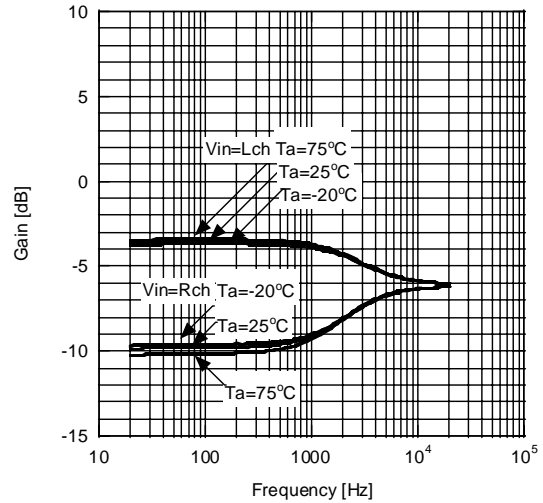

[CAUTION]

The specifications on this databook are only given for information, without any guarantee as regards either mistakes or omissions. The application circuits in this databook are described only to show representative usages of the product and not intended for the guarantee or permission of any right including the industrial rights.

Mouser Electronics

Authorized Distributor

Click to View Pricing, Inventory, Delivery & Lifecycle Information:

[NJR:](#)

[NJM2705SD3-TE1](#) [NJM2705V-TE2](#)

Компания «Life Electronics» занимается поставками электронных компонентов импортного и отечественного производства от производителей и со складов крупных дистрибьюторов Европы, Америки и Азии.

С конца 2013 года компания активно расширяет линейку поставок компонентов по направлению коаксиальный кабель, кварцевые генераторы и конденсаторы (керамические, пленочные, электролитические), за счёт заключения дистрибьюторских договоров

Мы предлагаем:

- Конкурентоспособные цены и скидки постоянным клиентам.
- Специальные условия для постоянных клиентов.
- Подбор аналогов.
- Поставку компонентов в любых объемах, удовлетворяющих вашим потребностям.
- Приемлемые сроки поставки, возможна ускоренная поставка.
- Доставку товара в любую точку России и стран СНГ.
- Комплексную поставку.
- Работу по проектам и поставку образцов.
- Формирование склада под заказчика.
- Сертификаты соответствия на поставляемую продукцию (по желанию клиента).
- Тестирование поставляемой продукции.
- Поставку компонентов, требующих военную и космическую приемку.
- Входной контроль качества.
- Наличие сертификата ISO.

В составе нашей компании организован Конструкторский отдел, призванный помогать разработчикам, и инженерам.

Конструкторский отдел помогает осуществить:

- Регистрацию проекта у производителя компонентов.
- Техническую поддержку проекта.
- Защиту от снятия компонента с производства.
- Оценку стоимости проекта по компонентам.
- Изготовление тестовой платы монтаж и пусконаладочные работы.



Тел: +7 (812) 336 43 04 (многоканальный)

Email: org@lifeelectronics.ru