

Model 345

HFF LVPECL VCXO

Features

- Ceramic Surface Mount Package
- Ultra-Low Phase Jitter Performance
- High Frequency Fundamental Crystal Design
- Frequency Range 100 – 250MHz *
- +3.3V Operation
- Output Enable Standard
- Tape and Reel Packaging, EIA-418

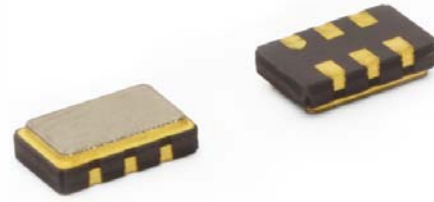

Part Dimensions:
5.0 × 3.2 × 1.2mm • 62.28mg

Applications

- Small Cells
- Wireless Communication
- Broadband Access
- SONET/SDH/DWDM
- Base Stations
- Ethernet/GbE/SyncE
- Digital Video
- Test and Measurement

| Standard Frequencies | |
|----------------------|---------------|
| - 100.00MHz | - 156.25MHz |
| - 122.88MHz | - 166.00MHz |
| - 125.00MHz | - 200.00MHz |
| - 153.60MHz | - 204.80MHz |
| - 155.52MHz | - 245.76MHz * |

* Check with factory for availability.

Description

CTS Model 345 is a low cost, small size, high performance VCXO. Employing the latest IC technology, coupled with a high frequency fundamental crystal, M345 has excellent stability and low jitter/phase noise performance.

Ordering Information

| Model | Supply Voltage | Absolute Pull Range | Frequency Stability | Temperature Range | Frequency Code [MHz] | Packaging |
|-------|-----------------------------|-----------------------------------|---|--|---|--------------------------------|
| 345 | L | B | 3 | I | XXX or XXXX | T |
| | Code Voltage L +3.3V ±5% | | Code Stability 3 ±50ppm 5 ±25ppm 6 ±20ppm ¹ | | Code Frequency Product Frequency Code ² | |
| | | Code APR B ±50ppm ³ | | Code Temp. Range C -20°C to +70°C I -40°C to +85°C | | Code Packing T 1k pcs./reel |

Notes:

- 1] Only available with "C" temperature range.
- 2] Refer to document 016-1454-0, Frequency Code Tables.
3-digits for frequencies <100MHz, 4-digits for frequencies 100MHz or greater.
- 3] Frequencies ≥200MHz, APR is ±30ppm.

**Not all performance combinations and frequencies may be available.
Contact your local CTS Representative or CTS Customer Service for availability.**

Electrical Specifications

Operating Conditions

| PARAMETER | SYMBOL | CONDITIONS | MIN | TYP | MAX | UNIT |
|-------------------------|-----------|--|------------|-----|------------|------------------|
| Maximum Supply Voltage | V_{CC} | - | -0.3 | - | 5.0 | V |
| Maximum Control Voltage | V_C | - | -0.5 | - | V_{CC} | V |
| Supply Voltage | V_{CC} | ±5% | 3.14 | 3.3 | 3.47 | V |
| Supply Current | I_{CC} | Typical @ LVPECL Load, $T_A = +25^\circ\text{C}$ | - | 65 | 80 | mA |
| Output Load | R_L | Terminated to $V_{CC} - 2.0\text{V}$ | - | 50 | - | Ohms |
| Operating Temperature | T_A | - | -20 -40 | +25 | +70 +85 | $^\circ\text{C}$ |
| Storage Temperature | T_{STG} | - | -40 | - | +100 | $^\circ\text{C}$ |

Frequency Stability

| PARAMETER | SYMBOL | CONDITIONS | MIN | TYP | MAX | UNIT |
|---------------------------------|-------------------|---|-----|--------------|-----|------|
| Frequency Range | f_0 | - | | 100 - 250 | | MHz |
| Frequency Stability [Note 1] | $\Delta f/f_0$ | ±20ppm stability, -20 $^\circ\text{C}$ to +70 $^\circ\text{C}$ only | | 20, 25 or 50 | | ±ppm |
| Absolute Pull Range [Note 2] | APR | Frequencies ≥200MHz, APR is ±30ppm | 50 | - | - | ±ppm |
| Aging | $\Delta f/f_{25}$ | First Year @ +25 $^\circ\text{C}$, nominal V_{CC} and V_C | -3 | - | 3 | ppm |

1.] Inclusive of initial tolerance at time of shipment, changes in supply voltage, load, temperature and 1st year aging.

2.] Minimum guaranteed frequency shift from f_0 over variations in temperature, aging, power supply and load.

Output Parameters

| PARAMETER | SYMBOL | CONDITIONS | MIN | TYP | MAX | UNIT |
|------------------------|----------------------|--|--------------------------------------|--------|--------------------------------------|---------------|
| Output Type | - | - | | LVPECL | | - |
| Output Voltage Levels | V_{OH} V_{OL} | LVPECL Load, -40 $^\circ\text{C}$ to +85 $^\circ\text{C}$ LVPECL Load, -40 $^\circ\text{C}$ to +85 $^\circ\text{C}$ | $V_{CC} - 1.085$ $V_{CC} - 1.810$ | - - | $V_{CC} - 0.880$ $V_{CC} - 1.620$ | V |
| Output Duty Cycle | SYM | @ $V_{CC} - 1.3\text{V}$ | 45 | - | 55 | % |
| Rise and Fall Time | T_R, T_F | @ 20%/80% Levels | - | 0.3 | 1.0 | ns |
| Start Up Time | T_S | Application of V_{CC} | - | 5 | 10 | ms |
| Enable Function | | | | | | |
| Enable Input Voltage | V_{IH} | Pin 2 Logic '1', Output Enabled | $0.7V_{CC}$ | - | - | V |
| Disable Input Voltage | V_{IL} | Pin 2 Logic '0', Output Disabled | - | - | $0.3V_{CC}$ | V |
| Standby Current | I_{STB} | Pin 2 Logic '0', Output Standby | - | - | 10 | μA |
| Enable Time | T_{PLZ} | Pin 2 Logic '1' | - | - | 20 | μs |
| Phase Jitter, RMS | t_{jrms} | Bandwidth 12 kHz - 20 MHz | - | 90 | 500 | fs |
| Phase Noise | - | See Typical Plots | - | - | - | - |

Enable Truth Table

| Pin 2 | Pin 4 & 5 |
|-----------|-----------|
| Logic '1' | Output |
| Open | Output |
| Logic '0' | High Imp. |

Electrical Specifications

Control Voltage

| PARAMETER | SYMBOL | CONDITIONS | MIN | TYP | MAX | UNIT |
|---------------------|----------------|-----------------------------------|------|-------------|------|-------|
| Control Voltage | V_C | - | 0.30 | 1.65 | 3.00 | V |
| Frequency Deviation | $\Delta f/f_0$ | $V_C = 0.0V$ | | -155 to -75 | | ppm |
| | | $V_C = 3.3V$ | | 75 to 155 | | |
| Linearity | L | Best Straight Line Fit | - | 5 | 10 | % |
| Gain Transfer | K_V | Pull Sensitivity; @ +1.65V, +25°C | - | 75 | - | ppm/V |
| Input Impedance | Z_{Vc} | - | 10 | - | - | MOhms |
| Modulation Roll-off | - | @ -3dB | 25 | - | - | kHz |
| Transfer Function | - | - | | Positive | | - |

Test Circuit

LVPECL

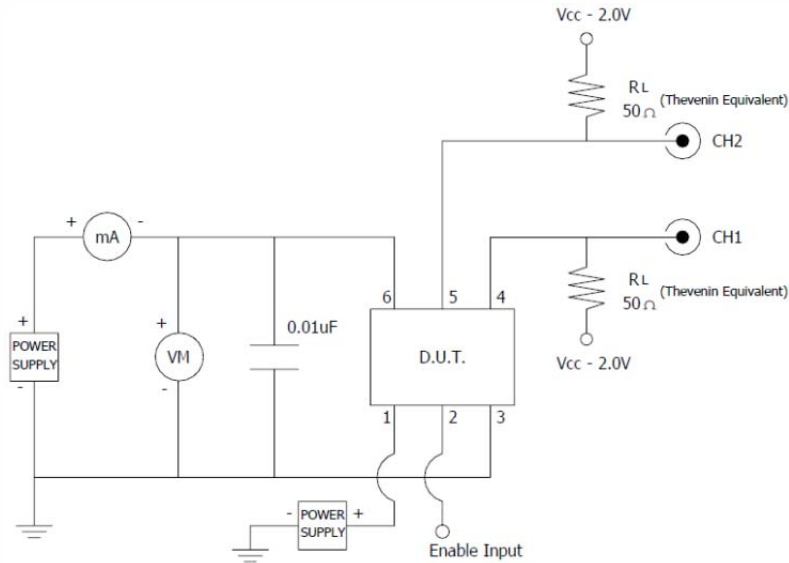

Output Waveform

LVPECL

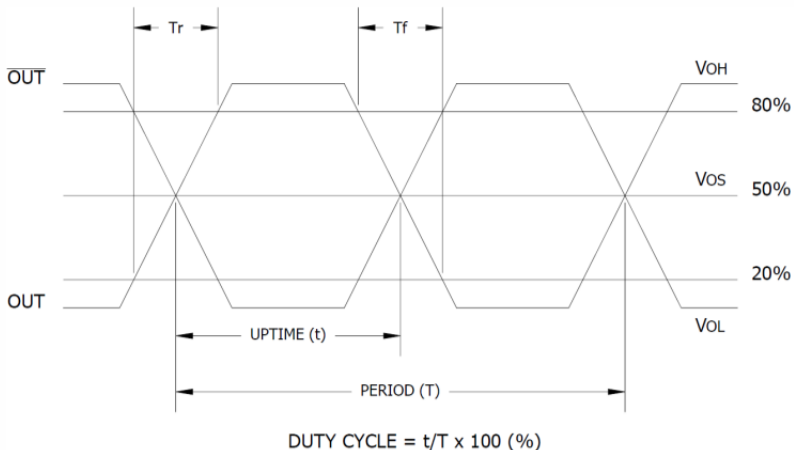

Electrical Specifications

Performance Data

Frequency Deviation – Over Temperature [typical]

122.88MHz, $V_{CC} = 3.3V$, $V_C = 1.65V$



156.25MHz, $V_{CC} = 3.3V$, $V_C = 1.65V$

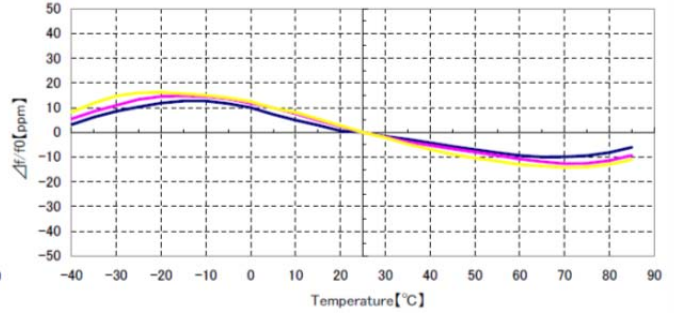

Frequency Deviation – Pulling Range [typical]

122.88MHz, $V_{CC} = 3.3V$, $T_A = +25^\circ V$

Pulling range



156.25MHz, $V_{CC} = 3.3V$, $T_A = +25^\circ V$

Pulling range

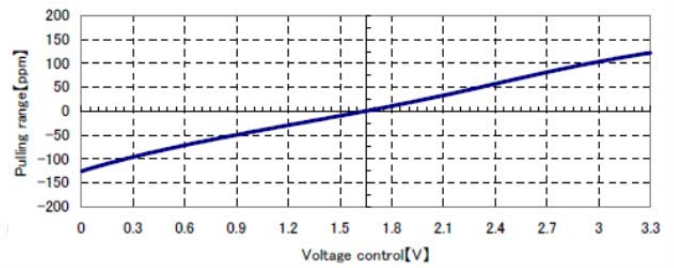

Frequency Deviation – Gain Transfer [typical]

122.88MHz, $V_{CC} = 3.3V$, $T_A = +25^\circ V$

Sensitivity

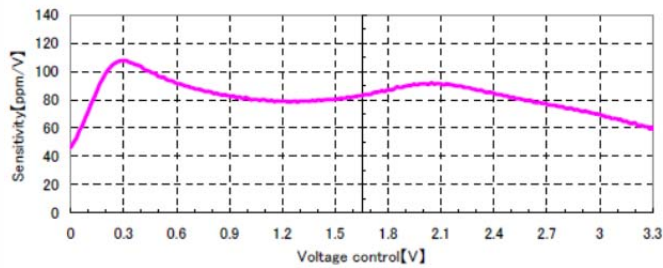

156.25MHz, $V_{CC} = 3.3V$, $T_A = +25^\circ V$

Sensitivity

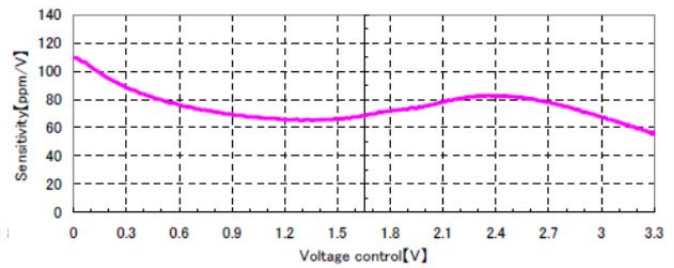



Electrical Specifications

Performance Data

Phase Noise [typical]

122.88MHz, $V_{CC} = 3.3V$, $V_C = 1.65V$, $T_A = +25^\circ C$



156.25MHz, $V_{CC} = 3.3V$, $V_C = 1.65V$, $T_A = +25^\circ C$



Mechanical Specifications

Package Drawing



Marking Information

- ** - Manufacturing Site Code.
- D - Date Code. See Table I for codes.
- ST - Frequency Stability/Temperature Code. [Refer to Ordering Information]
- V - Voltage Code. L = 3.3V
- xxxx - Frequency Code. 4-digits required for frequencies 100MHz and above. [See document 016-1454-0, Frequency Code Tables.]

Recommended Pad Layout



Notes

- Termination pads (e4). Barrier-plating is nickel [Ni] with gold [Au] flash plate.
- Reflow conditions per JEDEC J-STD-020; +260°C maximum, 20 seconds.
- MSL = 1.

Pin Assignments

| Pin | Symbol | Function |
|-----|-----------------|--------------------------|
| 1 | V _C | Control Voltage |
| 2 | EOH | Enable |
| 3 | GND | Circuit & Package |
| 4 | Output | RF Output |
| 5 | Output | RF Output, Complementary |
| 6 | V _{CC} | Supply Voltage |

Table I - Date Code

| YEAR | | MONTH | | | | | JAN | FEB | MAR | APR | MAY | JUN | JUL | AUG | SEP | OCT | NOV | DEC |
|------|------|-------|------|------|--|---|-----|-----|-----|-----|-----|-----|-----|-----|-----|-----|-----|-----|
| 2001 | 2005 | 2009 | 2013 | 2017 | | A | B | C | D | E | F | G | H | J | K | L | M | |
| 2002 | 2006 | 2010 | 2014 | 2018 | | N | P | Q | R | S | T | U | V | W | X | Y | Z | |
| 2003 | 2007 | 2011 | 2015 | 2019 | | a | b | c | d | e | f | g | h | j | k | l | m | |
| 2004 | 2008 | 2012 | 2016 | 2020 | | n | p | q | r | s | t | u | v | w | x | y | z | |

Packaging - Tape and Reel

Tape Drawing



Reel Drawing



Notes

1. Device quantity is 1k pieces maximum per 180mm reel.
2. Complete CTS part number, frequency value and date code information must appear on reel and carton labels.

Компания «Life Electronics» занимается поставками электронных компонентов импортного и отечественного производства от производителей и со складов крупных дистрибьюторов Европы, Америки и Азии.

С конца 2013 года компания активно расширяет линейку поставок компонентов по направлению коаксиальный кабель, кварцевые генераторы и конденсаторы (керамические, пленочные, электролитические), за счёт заключения дистрибьюторских договоров

Мы предлагаем:

- Конкуренеспособные цены и скидки постоянным клиентам.
- Специальные условия для постоянных клиентов.
- Подбор аналогов.
- Поставку компонентов в любых объемах, удовлетворяющих вашим потребностям.
- Приемлемые сроки поставки, возможна ускоренная поставка.
- Доставку товара в любую точку России и стран СНГ.
- Комплексную поставку.
- Работу по проектам и поставку образцов.
- Формирование склада под заказчика.
- Сертификаты соответствия на поставляемую продукцию (по желанию клиента).
- Тестирование поставляемой продукции.
- Поставку компонентов, требующих военную и космическую приемку.
- Входной контроль качества.
- Наличие сертификата ISO.

В составе нашей компании организован Конструкторский отдел, призванный помогать разработчикам, и инженерам.

Конструкторский отдел помогает осуществить:

- Регистрацию проекта у производителя компонентов.
- Техническую поддержку проекта.
- Защиту от снятия компонента с производства.
- Оценку стоимости проекта по компонентам.
- Изготовление тестовой платы монтаж и пусконаладочные работы.



Тел: +7 (812) 336 43 04 (многоканальный)

Email: org@lifeelectronics.ru