

# Solid-state Timer H3YN

CSM\_H3YN\_DS\_E\_5\_1

## Miniature Timer with Multiple Time Ranges and Multiple Operating Modes

- Minimizes stock.
- Pin configuration compatible with MY Power Relay.
- Standard multiple operating modes and multiple time ranges.
- Conforms to EN61812-1 and IEC60664-1 for Low Voltage, and EMC Directives.



For the most recent information on models that have been certified for safety standards, refer to your OMRON website.

## Model Number Structure

### Model Number Legend

H3YN-    -    
          1  2  3

#### 1. Output

- 2: DPDT
- 4: 4PDT

#### 2. Time Range

- None: Short-time range (0.1 s to 10 min)
- 1: Long-time range (0.1 min to 10 hrs)

#### 3. Contact Type

- None: Single contact
- Z: Twin contacts

## Ordering Information

### List of Models

| Supply voltage   | Time-limit contact   | Short-time range model<br>(0.1 s to 10 min) | Long-time range model<br>(0.1 min to 10 h) |
|--|----------------------|---|--|
| 24, 100 to 120, 200 to 230 VAC;<br>12, 24, 48, 100 to 110, 125 VDC | DPDT                 | H3YN-2                                      | H3YN-21                                    |
|  | 4PDT                 | H3YN-4                                      | H3YN-41                                    |
| 24 VDC   | 4PDT (Twin contacts) | H3YN-4-Z                                    | H3YN-41-Z                                  |

**Note:** Specify both the model number and supply voltage when ordering.

Example: H3YN-2 24 VAC

Supply voltage

**Note:** 1. Sockets and Hold-down Clips are not included with the H3YN. They must be ordered separately.

2. Only models with 24-VDC power supply are available.

3. Use the H3YN-4 or H3YN-41 Series when switching micro loads, and use the H3YN-4-Z or H3YN-41-Z Series when switching even smaller loads.

## ■ Accessories (Order Separately)

### Adapter, Mounting Plate, Clip

| Name/specification        |                   | Model   |
|---------------------------|-------------------|---------|
| Flush mounting adapter    |                   | Y92F-78 |
| Mounting Plate for Socket | For 1 Socket      | PYP-1   |
|                           | For 18 Sockets    | PYP-18  |
| Clip                      | For PYF□A         | Y92H-3  |
|                           | For PY□ and PYF□M | Y92H-4  |

**Note:** For details, refer to NTLPxREFERENCE *Socket and DIN Track Products*.

### Socket

| Timer   |                  | Square Sockets |                  |  |          |
|---------|------------------|----------------|------------------|--|----------|
| Contact | Model            | Pin            | Connection       | Terminal                               | Model    |
| DPDT    | H3Y-2<br>H3YN-2□ | 8-pin          | Front Connecting | DIN track mounting                     | PYF08A   |
|         |                  |                |                  | DIN track mounting (Finger-safe tyape) | PYF08A-E |
|         |                  |                | Back Connecting  | Screw mounting                         | PYF08F   |
|         |                  |                |                  | Solder terminal                        | PY08     |
| 4PDT    | H3Y-4<br>H3YN-4□ | 14-pin         | Front Connecting | DIN track mounting                     | PYF14A   |
|         |                  |                |                  | DIN track mounting (Finger-safe tyape) | PYF14A-E |
|         |                  |                | Back Connecting  | Solder terminal                        | PY14     |

- Note:**
1. Cannot be used with the H3Y-□-0 (PCB terminals).
  2. The PYF□□A-E has a finger-protection structure. Round crimp terminals cannot be used. Use forked crimp terminals.
  3. For details, refer to *Socket and DIN Track Products*.

# Specifications

## ■ Ratings

| Item                                  | H3YN-2/-4/-4-Z  | H3YN-21/-41/-41-Z   |
|---------------------------------------|---|---|
| Time ranges                           | 0.1 s to 10 min (1 s, 10 s, 1 min, or 10 min max. selectable)   | 0.1 min to 10 h (1 min, 10 min, 1 h, or 10 h max. selectable) |
| Rated supply voltage (See note 5, 6.) | 24, 100 to 120, 200 to 230 VAC (50/60 Hz) (See note 1.)<br>12, 24, 48, 100 to 110, 125 VDC (See note 2.)  |   |
| Pin type                              | Plug-in   |   |
| Operating mode                        | ON-delay, interval, flicker OFF start, or flicker ON start (selectable with DIP switch)   |   |
| Operating voltage range               | 85% to 110% of rated supply voltage (12 VDC: 90% to 110% of rated supply voltage) (See note 3.)   |   |
| Reset voltage                         | 10% min. of rated supply voltage (See note 4.)  |   |
| Power consumption                     | 100 to 120 VAC: Relay ON: Approx. 1.8 VA (1.6 W) at 120 VAC, 60 Hz<br>Relay OFF: Approx. 1 VA (0.6 W) at 120 VAC, 60 Hz<br>200 to 230 VAC: Relay ON: Approx. 2.2 VA (1.8 W) at 230 VAC, 60 Hz<br>Relay OFF: Approx. 1.5 VA (1.1 W) at 230 VAC, 60 Hz<br>24 VAC: Relay ON: Approx. 1.8 VA (1.4 W) at 24 VAC, 60 Hz<br>Relay OFF: Approx. 0.3 VA (0.2 W) at 24 VAC, 60 Hz<br>12 VDC: Relay ON: Approx. 1.1 W at 12 VDC<br>Relay OFF: Approx. 0.1 W at 12 VDC<br>24 VDC: Relay ON: Approx. 1.1 W at 24 VDC<br>Relay OFF: Approx. 0.1 W at 24 VDC<br>48 VDC: Relay ON: Approx. 1.2 W at 48 VDC<br>Relay OFF: Approx. 0.3 W at 48 VDC<br>100 to 110 VDC: Relay ON: Approx. 1.6 W at 110 VDC<br>Relay OFF: Approx. 0.4 W at 110 VDC<br>125 VDC: Relay ON: Approx. 1.6 W at 125 VDC<br>Relay OFF: Approx. 0.4 W at 125 VDC |   |
| Control outputs                       | DPDT: 5 A at 250 VAC, resistive load ( $\cos\phi = 1$ )<br>4PDT: 3 A at 250 VAC, resistive load ( $\cos\phi = 1$ )  |   |

- Note:**
1. Do not use the output from an inverter as the power supply. Refer to *Safety Precautions for All Timers* for details.
  2. Single-phase, full-wave-rectified power supplies can be used.
  3. When using the H3YN continuously in any place where the ambient temperature is in a range of 45°C to 50°C, supply 90% to 110% of the rated supply voltages (supply 95% to 110% with 12 VDC type).
  4. Set the reset voltage as follows to ensure proper resetting.
    - 100 to 120 VAC: 10 VAC max.
    - 200 to 230 VAC: 20 VAC max.
    - 100 to 110 VDC: 10 VDC max.
  5. Refer to *Safety Precautions for All Timers* when combining the Timer with an AC 2-wire proximity sensor.
  6. A diode to prevent reverse voltages is provided only on models with a DC power supply.

## ■ Characteristics

| Item                       | H3YN-2/-21/-4/-41   |
|----------------------------|---|
| Accuracy of operating time | ±1% FS max. (1 s range: ±1%±10 ms max.)   |
| Setting error              | ±10%±50 ms FS max.  |
| Reset time                 | Min. power-opening time: 0.1 s max. (including halfway reset)   |
| Influence of voltage       | ±2% FS max.   |
| Influence of temperature   | ±2% FS max.   |
| Insulation resistance      | 100 MΩ min. (at 500 VDC)  |
| Dielectric strength        | 2,000 VAC, 50/60 Hz for 1 min (between current-carrying terminals and exposed non-current-carrying metal parts) (see note 1)<br>2,000 VAC, 50/60 Hz for 1 min (between operating power circuit and control output)<br>2,000 VAC, 50/60 Hz for 1 min (between different pole contacts; 2-pole model)<br>1,500 VAC, 50/60 Hz for 1 min (between different pole contacts; 4-pole model)<br>1,000 VAC, 50/60 Hz for 1 min (between non-continuous contacts)                                 |
| Vibration resistance       | Destruction: 10 to 55 Hz, 0.75-mm single amplitude for 1 h each in 3 directions<br>Malfunction: 10 to 55 Hz, 0.5-mm single amplitude for 10 min each in 3 directions  |
| Shock resistance           | Destruction: 1,000 m/s <sup>2</sup><br>Malfunction: 100 m/s <sup>2</sup>  |
| Ambient temperature        | Operating: -10°C to 50°C (with no icing)<br>Storage: -25°C to 65°C (with no icing)  |
| Ambient humidity           | Operating: 35% to 85%   |
| Life expectancy            | Mechanical: 10,000,000 operations min. (under no load at 1,800 operations/h)<br>Electrical: DPDT:<br>500,000 operations min. (5 A at 250 VAC, resistive load at 1,800 operations/h)<br>4PDT:<br>200,000 operations min. (H3YN-4-Z/-41-Z: 100,000 operations min.)<br>(3 A at 250 VAC, resistive load at 1,800 operations/h) (see note 2)  |
| Impulse withstand voltage  | Between power terminals:<br>3 kV for 100 to 120 VAC, 200 to 230 VAC, 100 to 110 VDC, 125 VDC<br>1 kV for 12 VDC, 24 VDC, 48 VDC, 24 VAC<br>Between exposed non-current-carrying metal parts:<br>4.5 kV for 100 to 120 VAC, 200 to 230 VAC, 100 to 110 VDC, 125 VDC<br>1.5 kV for 12 VDC, 24 VDC, 48 VDC, 24 VAC   |
| Noise immunity             | ±1.5 kV, square-wave noise by noise simulator (pulse width: 100 ns/1 μs, 1-ns rise)   |
| Static immunity            | Destruction: 8 kV<br>Malfunction: 4 kV  |
| Degree of protection       | IP40  |
| Weight                     | Approx. 50 g  |
| EMC                        | (EMI) EN61812-1<br>Emission Enclosure: EN55011 Group 1 class A<br>Emission AC Mains: EN55011 Group 1 class A<br>(EMS) EN61812-1<br>Immunity ESD: EN61000-4-2: 8 kV air discharge (level 3)<br>Immunity RF-interference from AM Radio Waves:<br>EN61000-4-3: 10 V/m (80 MHz to 1 GHz) (level 3)<br>Immunity Burst: EN61000-4-4: 2 kV power-line (level 3)<br>2 kV I/O signal-line (level 4)<br>Immunity Surge: EN61000-4-5: 2 kV line to ground (level 3)<br>1 kV line to line (level 3) |
| Approved standards         | UL508, CSA C22.2 No. 14, Lloyds<br>Conforms to EN61812-1 and IEC60664-1. (2.5 kV/2 for H3YN-2/-21, 2.5 kV/1 for H3YN-4/-41, H3YN-4-Z/-41-Z)<br>Output category according to EN60947-5-1.  |

- Note:** 1. Terminal screw sections are excluded.  
2. Refer to the *Life-test Curve*.

## Life-test Curve (Reference Value)

### H3YN-2/-21



Reference: A maximum current of 0.6 A can be switched at 125 VDC ( $\cos\phi = 1$ ).  
Maximum current of 0.2 A can be switched if L/R is 7 ms. In both cases,  
a life of 100,000 operations can be expected.  
 The minimum applicable load is 1 mA at 5 VDC (P reference value).

### H3YN-4/-41



Reference: A maximum current of 0.5 A can be switched at 125 VDC ( $\cos\phi = 1$ ).  
Maximum current of 0.2 A can be switched if L/R is 7 ms. In both cases,  
a life of 100,000 operations can be expected.  
 The minimum applicable load is 1 mA at 1 VDC (P reference value).

### H3YN-4-Z/-41-Z



Reference: A maximum current of 0.5 A can be switched at 125 VDC ( $\cos\phi = 1$ ).  
Maximum current of 0.2 A can be switched if L/R is 7 ms. In both cases,  
a life of 100,000 operations can be expected.  
 The minimum applicable load is 0.1 mA at 1 VDC (P reference value).

# Connections

## ■ Connection

H3YN-2/-21



(Bottom View)

DIN Indication

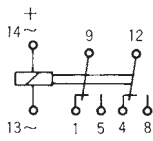

H3YN-4/-41  
H3YN-4-Z/-41-Z



(Bottom View)

DIN Indication



## Pulse Operation

A pulse output for a certain period can be obtained with a random external input signal. Use the H3YN in interval mode as shown in the following timing charts.

H3YN-2/-21



Note: t: Set time  
Rt: Reset time

H3YN-4/-41  
H3YN-4-Z/-41-Z



Note: t: Set time  
Rt: Reset time

**Caution**  
Be careful when connecting wires.

| Mode   | Terminals  |
|--|--|
| Pulse operation                              | Power supply between 9 and 14<br>Short-circuit between 5 and 13<br>Input signal between 9 and 13 |
| Operating mode; interval and all other modes | Power supply between 13 and 14   |

# Operation

## ■ Timing Chart

| Operating mode               | Timing chart |            |
|------------------------------|--------------|------------|
|                              | H3YN-2/-21   | H3YN-4/-41 |
| <b>ON-delay</b><br>          |              |            |
| <b>Interval</b><br>          |              |            |
| <b>Flicker OFF-start</b><br> |              |            |
| <b>Flicker ON-start</b><br>  |              |            |

**Note:** t: Set time  
 Rt: Reset time

## ■ DIP Switch Settings

The 1-s range and ON-delay mode for H3YN-2/-4/-4-Z, the 1-min range and ON-delay mode for H3YN-21/-41/-41-Z are factory-set before shipping.

### Time Ranges

| Model                            | Time range | Time setting range | Setting | Factory-set |
|----------------------------------|------------|--------------------|---------|-------------|
| H3YN-2,<br>H3YN-4<br>H3YN-4-Z    | 1 s        | 0.1 to 1 s         |         | Yes         |
|                                  | 10 s       | 1 to 10 s          |         | No          |
|                                  | 1 min      | 0.1 to 1 min       |         | No          |
|                                  | 10 min     | 1 to 10 min        |         | No          |
| H3YN-21,<br>H3YN-41<br>H3YN-41-Z | 1 min      | 0.1 to 1 min       |         | Yes         |
|                                  | 10 min     | 1 to 10 min        |         | No          |
|                                  | 1 h        | 0.1 to 1 h         |         | No          |
|                                  | 10 h       | 1 to 10 h          |         | No          |



**Note:** The top two DIP switch pins are used to select the time ranges.

### Operating Modes

| Operating mode    | Setting | Factory-set |
|-------------------|---------|-------------|
| ON-delay          |         | Yes         |
| Interval          |         | No          |
| Flicker OFF-start |         | No          |
| Flicker ON-start  |         | No          |

**Note:** The bottom two DIP switch pins are used to select the operating mode.

## Nomenclature





# Dimensions

Note: All units are in millimeters unless otherwise indicated.

## Timers

### H3YN-2/-21 Front Mounting



### H3YN-4/-41 Front Mounting H3YN-4-Z/-41-Z

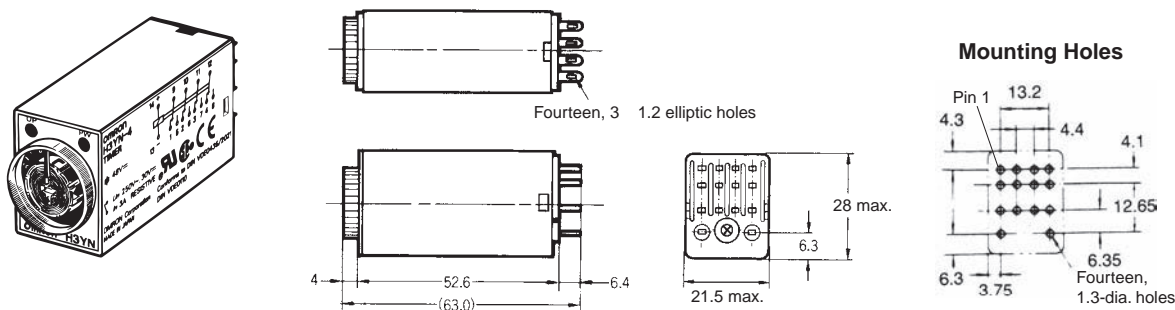

### Mounting Height

PYF08A/PYF08A-N/PYF08A-E  
(PYF14A/PYF14A-N/PYF14A-E  
(see note))

PY08 (PY14 (see note))

PY08QN (PY14QN (see note))

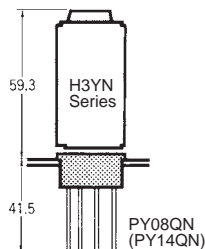
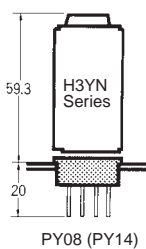

Note: Models in parentheses are Connecting Sockets to the H3YN-4/-41 or H3YN-4-Z/-41-Z.

## ■ Accessories (Order Separately)

### Connecting Sockets

Use the PYF□A, PY□, PY□-02, or PY□QN(2) to mount the H3YN. When ordering any one of these Sockets, replace "□" with "08" or "14."

#### Track Mounting/Front Connecting Sockets

##### PYF08A



##### Terminal Arrangement (Top View)



##### Mounting Holes



##### PYF-14A



##### Terminal Arrangement (Top View)



##### Mounting Holes



##### PYF-08A-N



##### Terminal Arrangement



##### Mounting Holes (for Surface Mounting)



##### PYF-14A-N



##### Terminal Arrangement



##### Mounting Holes (for Surface Mounting)



## PYF08A-E



(Top View)



## PYF14A-E



(Top View)

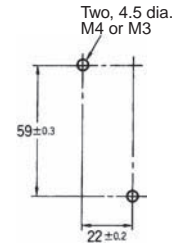

## Back Connecting Sockets PY08, PY14



Terminal Arrangement  
(Bottom View)

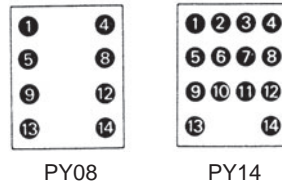

Panel Cutout



PY□, PY□-02,  
PY□QN(2)

## PY08QN, PY14QN PY08QN(2), PY14QN(2)

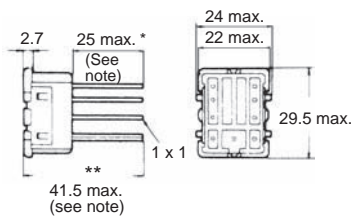

Terminal Arrangement  
(Bottom View)



**Note:** With PY□QN(2)-(3), dimension \* should read 20 max. and dimension \*\* 36.5 max.

## PY08-02, PY14-02



Terminal Arrangement  
(Bottom View)



## Flush Mounting Adapter

Y92F-78



- Note:**
1. Push the H3YN in until the Adaptor (Y92F-78) hooks engage with its rear panel.
  2. Do not round the corners of the cutout on the rear panel surface, otherwise the Adaptor (Y92F-78) tabs may not engage properly.

## Socket Mounting Plates

The PYP-1 is a Socket Mounting Plate for a single Socket and the PYP-18 is a Socket Mounting Plate for 18 Sockets. The PYP-18 can be cut appropriately according to the number of Sockets to be used.

PYP-1



PYP-18

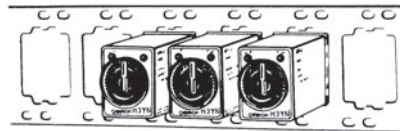
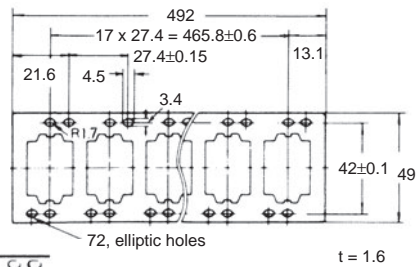

## Hold-down Clips

The Hold-down Clip makes it possible to mount the H3YN securely and prevent the H3YN from falling out due to vibration or shock.

Y92H-3  
Y92H-4

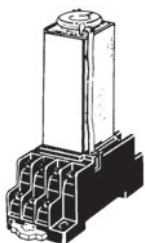

Y92H-3 for  
PYF□A Socket  
(Set of Two Clips)



Y92H-4 for  
PY□ Socket



## Safety Precautions

Refer to *Safety Precautions for All Timers*.

### ■ Correct Use

The operating voltage will increase when using the H3YN continuously in any place where the ambient temperature is in a range of 45°C to 50°C. Supply 90% to 110% of the rated voltages (at 12 VDC: 95% to 110%).

Do not leave the H3YN in time-up condition for a long period of time (for example, more than one month in any place where the ambient temperature is high), otherwise the internal parts (aluminum electrolytic capacitor) may become damaged. Therefore, the use of the H3YN with a relay as shown in the following circuit diagram is recommended to extend the service life of the H3YN.



⊗: Auxiliary relay such as MY Relay

The H3YN must be disconnected from the Socket when setting the DIP switch, otherwise the user may touch a terminal imposed with a high voltage and get an electric shock.

Do not connect the H3YN as shown in the following circuit diagram on the right hand side, otherwise the H3YN's internal contacts different from each other in polarity may become short-circuited.



Use the following safety circuit when building a self-holding or self-resetting circuit with the H3YN and an auxiliary relay, such as an MY Relay, in combination.



In the case of the above circuit, the H3YN will be in pulse operation. Therefore, if the circuit shown on page 6 is used, no auxiliary relay will be required.

Do not set to the minimum setting in the flicker modes, otherwise the contact may become damaged.

Be careful not to apply any voltage to the terminal screws on the back of the Timer. Mount the product so that the screws will not come in contact with the panel or metal parts.

Do not use the H3YN in places where there is excessive dust, corrosive gas, or direct sunlight.

Do not mount more than one H3YN closely together, otherwise the internal parts may become damaged. Make sure that there is a space of 5 mm or more between any H3YN models next to each other to allow heat radiation.

The internal parts may become damaged if a supply voltage other than the rated ones is imposed on the H3YN.

In order to conform to UL and CSA requirements when using the H3YN-4/-41 or H3YN-4-Z/-41-Z, connect the Unit so that output contacts (contacts of different poles) have the same electric potential.

In cases such as PLC input where the load is extremely small for the control output of a timer containing a power relay (using other than gold-plated contacts), reliability can be increased by using contacts of the same poles (e.g., the H3Y-2) in parallel.

### ■ Precautions for EN61812-1 Conformance

The H3YN as a built-in timer conforms to EN61812-1 provided that the following conditions are satisfied.

#### Handling

Do not touch the DIP switch while power is supplied to the H3YN.

Before dismantling the H3YN from the Socket, make sure that no voltage is imposed on any terminal of the H3YN.

The applicable Socket is the PYF□A.

Only basic insulation is ensured between the Y92H-3 Hold-down Clips and H3YN internal circuits.

Do not allow the Y92H-3 Hold-down Clips to contact other parts.

The insulation test voltage between different pole contacts for the 4-pole model is the impulse voltage of 2.95 kV.

#### Wiring

The power supply for the H3YN must be protected with equipment such as a breaker approved by VDE.

Basic insulation is ensured between the H3YN's operating circuit and control output.

Basic insulation: Overvoltage category II, pollution degree 1 (H3YN-4/-41, H3YN-4-Z/-41-Z), pollution degree 2 (H3YN-2/-21) (with a clearance of 1.5 mm and a creepage distance of 2.5 mm at 240 VAC)

ALL DIMENSIONS SHOWN ARE IN MILLIMETERS.

To convert millimeters into inches, multiply by 0.03937. To convert grams into ounces, multiply by 0.03527.

In the interest of product improvement, specifications are subject to change without notice.

## Read and Understand This Catalog

Please read and understand this catalog before purchasing the products. Please consult your OMRON representative if you have any questions or comments.

## Warranty and Limitations of Liability

### WARRANTY

OMRON's exclusive warranty is that the products are free from defects in materials and workmanship for a period of one year (or other period if specified) from date of sale by OMRON.

OMRON MAKES NO WARRANTY OR REPRESENTATION, EXPRESS OR IMPLIED, REGARDING NON-INFRINGEMENT, MERCHANTABILITY, OR FITNESS FOR PARTICULAR PURPOSE OF THE PRODUCTS. ANY BUYER OR USER ACKNOWLEDGES THAT THE BUYER OR USER ALONE HAS DETERMINED THAT THE PRODUCTS WILL SUITABLY MEET THE REQUIREMENTS OF THEIR INTENDED USE. OMRON DISCLAIMS ALL OTHER WARRANTIES, EXPRESS OR IMPLIED.

### LIMITATIONS OF LIABILITY

OMRON SHALL NOT BE RESPONSIBLE FOR SPECIAL, INDIRECT, OR CONSEQUENTIAL DAMAGES, LOSS OF PROFITS OR COMMERCIAL LOSS IN ANY WAY CONNECTED WITH THE PRODUCTS, WHETHER SUCH CLAIM IS BASED ON CONTRACT, WARRANTY, NEGLIGENCE, OR STRICT LIABILITY.

In no event shall the responsibility of OMRON for any act exceed the individual price of the product on which liability is asserted.

IN NO EVENT SHALL OMRON BE RESPONSIBLE FOR WARRANTY, REPAIR, OR OTHER CLAIMS REGARDING THE PRODUCTS UNLESS OMRON'S ANALYSIS CONFIRMS THAT THE PRODUCTS WERE PROPERLY HANDLED, STORED, INSTALLED, AND MAINTAINED AND NOT SUBJECT TO CONTAMINATION, ABUSE, MISUSE, OR INAPPROPRIATE MODIFICATION OR REPAIR.

## Application Considerations

### SUITABILITY FOR USE

OMRON shall not be responsible for conformity with any standards, codes, or regulations that apply to the combination of products in the customer's application or use of the products.

At the customer's request, OMRON will provide applicable third party certification documents identifying ratings and limitations of use that apply to the products. This information by itself is not sufficient for a complete determination of the suitability of the products in combination with the end product, machine, system, or other application or use.

The following are some examples of applications for which particular attention must be given. This is not intended to be an exhaustive list of all possible uses of the products, nor is it intended to imply that the uses listed may be suitable for the products:

- Outdoor use, uses involving potential chemical contamination or electrical interference, or conditions or uses not described in this catalog.
- Nuclear energy control systems, combustion systems, railroad systems, aviation systems, medical equipment, amusement machines, vehicles, safety equipment, and installations subject to separate industry or government regulations.
- Systems, machines, and equipment that could present a risk to life or property.

Please know and observe all prohibitions of use applicable to the products.

NEVER USE THE PRODUCTS FOR AN APPLICATION INVOLVING SERIOUS RISK TO LIFE OR PROPERTY WITHOUT ENSURING THAT THE SYSTEM AS A WHOLE HAS BEEN DESIGNED TO ADDRESS THE RISKS, AND THAT THE OMRON PRODUCTS ARE PROPERLY RATED AND INSTALLED FOR THE INTENDED USE WITHIN THE OVERALL EQUIPMENT OR SYSTEM.

### PROGRAMMABLE PRODUCTS

OMRON shall not be responsible for the user's programming of a programmable product, or any consequence thereof.

## Disclaimers

### CHANGE IN SPECIFICATIONS

Product specifications and accessories may be changed at any time based on improvements and other reasons.

It is our practice to change model numbers when published ratings or features are changed, or when significant construction changes are made. However, some specifications of the products may be changed without any notice. When in doubt, special model numbers may be assigned to fix or establish key specifications for your application on your request. Please consult with your OMRON representative at any time to confirm actual specifications of purchased products.

### DIMENSIONS AND WEIGHTS

Dimensions and weights are nominal and are not to be used for manufacturing purposes, even when tolerances are shown.

### PERFORMANCE DATA

Performance data given in this catalog is provided as a guide for the user in determining suitability and does not constitute a warranty. It may represent the result of OMRON's test conditions, and the users must correlate it to actual application requirements. Actual performance is subject to the OMRON Warranty and Limitations of Liability.

### ERRORS AND OMISSIONS

The information in this document has been carefully checked and is believed to be accurate; however, no responsibility is assumed for clerical, typographical, or proofreading errors, or omissions.

2013.1

In the interest of product improvement, specifications are subject to change without notice.

**OMRON Corporation**  
Industrial Automation Company

<http://www.ia.omron.com/>

(c)Copyright OMRON Corporation 2013 All Right Reserved.

Компания «Life Electronics» занимается поставками электронных компонентов импортного и отечественного производства от производителей и со складов крупных дистрибьюторов Европы, Америки и Азии.

С конца 2013 года компания активно расширяет линейку поставок компонентов по направлению коаксиальный кабель, кварцевые генераторы и конденсаторы (керамические, пленочные, электролитические), за счёт заключения дистрибьюторских договоров

Мы предлагаем:

- Конкуренспособные цены и скидки постоянным клиентам.
- Специальные условия для постоянных клиентов.
- Подбор аналогов.
- Поставку компонентов в любых объемах, удовлетворяющих вашим потребностям.
- Приемлемые сроки поставки, возможна ускоренная поставка.
- Доставку товара в любую точку России и стран СНГ.
- Комплексную поставку.
- Работу по проектам и поставку образцов.
- Формирование склада под заказчика.
- Сертификаты соответствия на поставляемую продукцию (по желанию клиента).
- Тестирование поставляемой продукции.
- Поставку компонентов, требующих военную и космическую приемку.
- Входной контроль качества.
- Наличие сертификата ISO.

В составе нашей компании организован Конструкторский отдел, призванный помогать разработчикам, и инженерам.

Конструкторский отдел помогает осуществить:

- Регистрацию проекта у производителя компонентов.
- Техническую поддержку проекта.
- Защиту от снятия компонента с производства.
- Оценку стоимости проекта по компонентам.
- Изготовление тестовой платы монтаж и пусконаладочные работы.



Тел: +7 (812) 336 43 04 (многоканальный)

Email: [org@lifeelectronics.ru](mailto:org@lifeelectronics.ru)