

**SINGLE STAGE PRIMARY SIDE REGULATION PFC CONTROLLER
FOR DIMMABLE LED DRIVER**

Description

The AP1690 is a high performance AC/DC universal input Primary Side Regulation Power Factor Controller for dimmable LED driver applications.

The AP1690 provides accurate constant current (CC) regulation while removing the opto-coupler and secondary control circuitry. It also eliminates the need of loop compensation circuitry while maintaining stability. The AP1690 achieves excellent regulation and high efficiency, yet meets the requirement of IEC61000-3-2 harmonic standard.

The AP1690 features low start-up current, low operation current and high efficiency. It also has rich protection features including over voltage, short circuit, over current, over temperature protection etc. In order to regulate the output current of LED current with the phase of dimmer, pin 2 and pin 3 are used to set the peak current of transformer according to the voltage applied to these two pins.

The AP1690 is available in SO-8 package.

Features

- Primary Side Control for Output Current Regulation Without Opto-coupler and Secondary CV/CC Control Circuitry
- Low Start-up Current
- Good Dimmer Compatibility
- Tight CC Regulation Performance for Universal Input Mains Voltage Range
- Eliminates Control Loop Compensation Circuitry
- Built-in Acceleration Start
- LED Open Protection
- LED Short Circuit Protection
- Over Temperature Protection
- Over Current Protection
- Cost Effective for Dimmable LED Driver Solution
- **Totally Lead-Free & Fully RoHS Compliant (Notes 1 & 2)**
- **Halogen and Antimony Free. "Green" Device (Note 3)**

- Notes:
1. No purposely added lead. Fully EU Directive 2002/95/EC (RoHS), 2011/65/EU (RoHS 2) & 2015/863/EU (RoHS 3) compliant.
 2. See <https://www.diodes.com/quality/lead-free/> for more information about Diodes Incorporated's definitions of Halogen- and Antimony-free, "Green" and Lead-free.
 3. Halogen- and Antimony-free "Green" products are defined as those which contain <900ppm bromine, <900ppm chlorine (<1500ppm total Br + Cl) and <1000ppm antimony compounds.

Pin Assignments

(Top View)

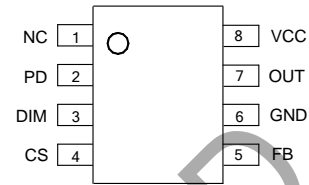

(SO-8)

Applications

- Single Stage Power Factor Correction Power Supply for Dimmable LED Lighting

Typical Applications Circuit

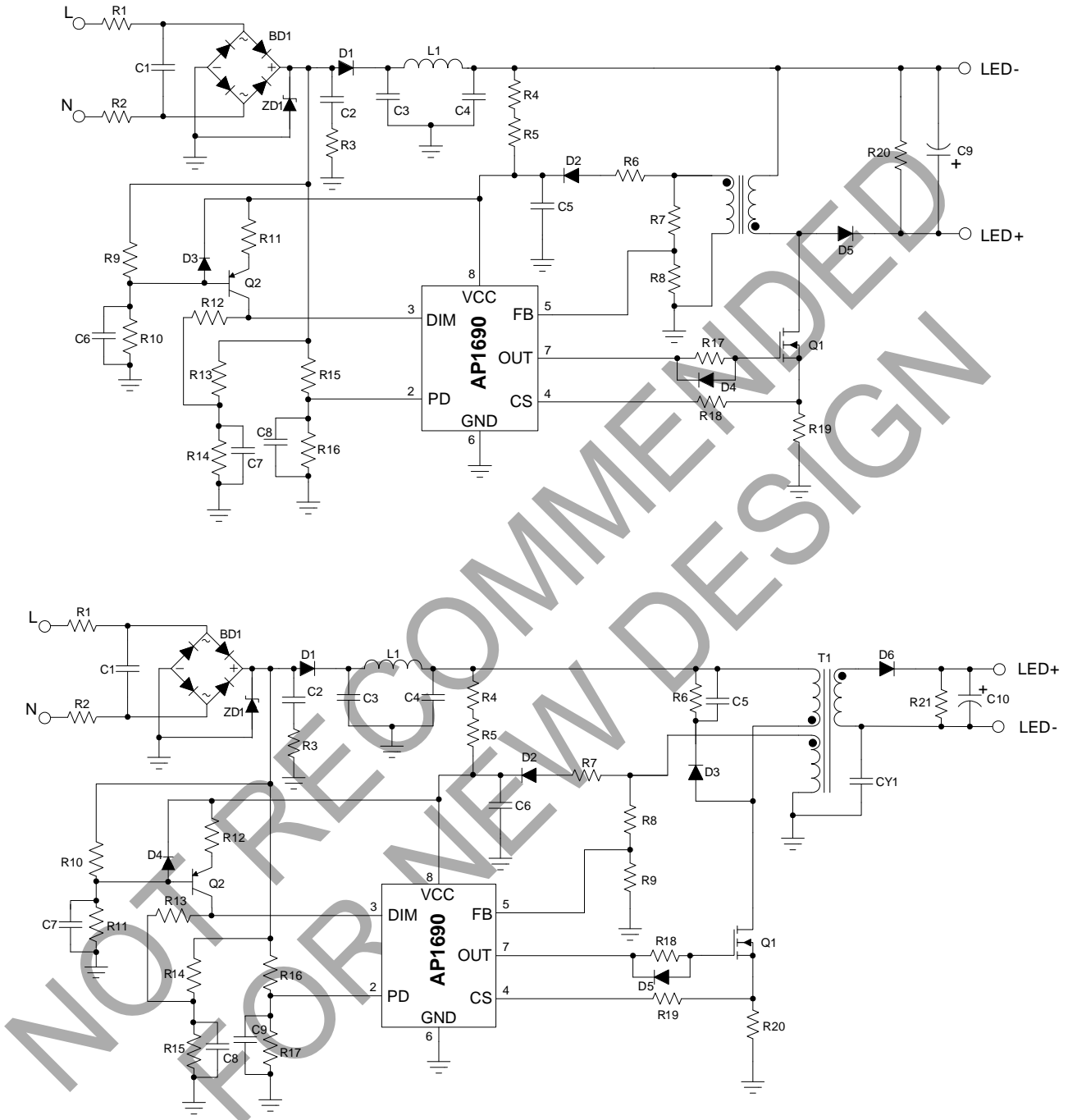

Isolated

Pin Descriptions

Pin Number	Pin Name	Function
1	NC	No connection
2	PD	The rectified input voltage sensing pin. The pin is detecting the phase of dimmer
3	DIM	The rectified input voltage sensing pin. The pin is detecting the average AC input voltage
4	CS	Primary current sensing
5	FB	This pin captures the feedback voltage from the auxiliary winding. FB voltage is used to control no load output voltage and determine acceleration stop point at start-up phase
6	GND	Ground. Current return for gate driver and control circuits of the IC
7	OUT	Gate driver output
8	VCC	Supply voltage of gate driver and control circuits of the IC

Functional Block Diagram

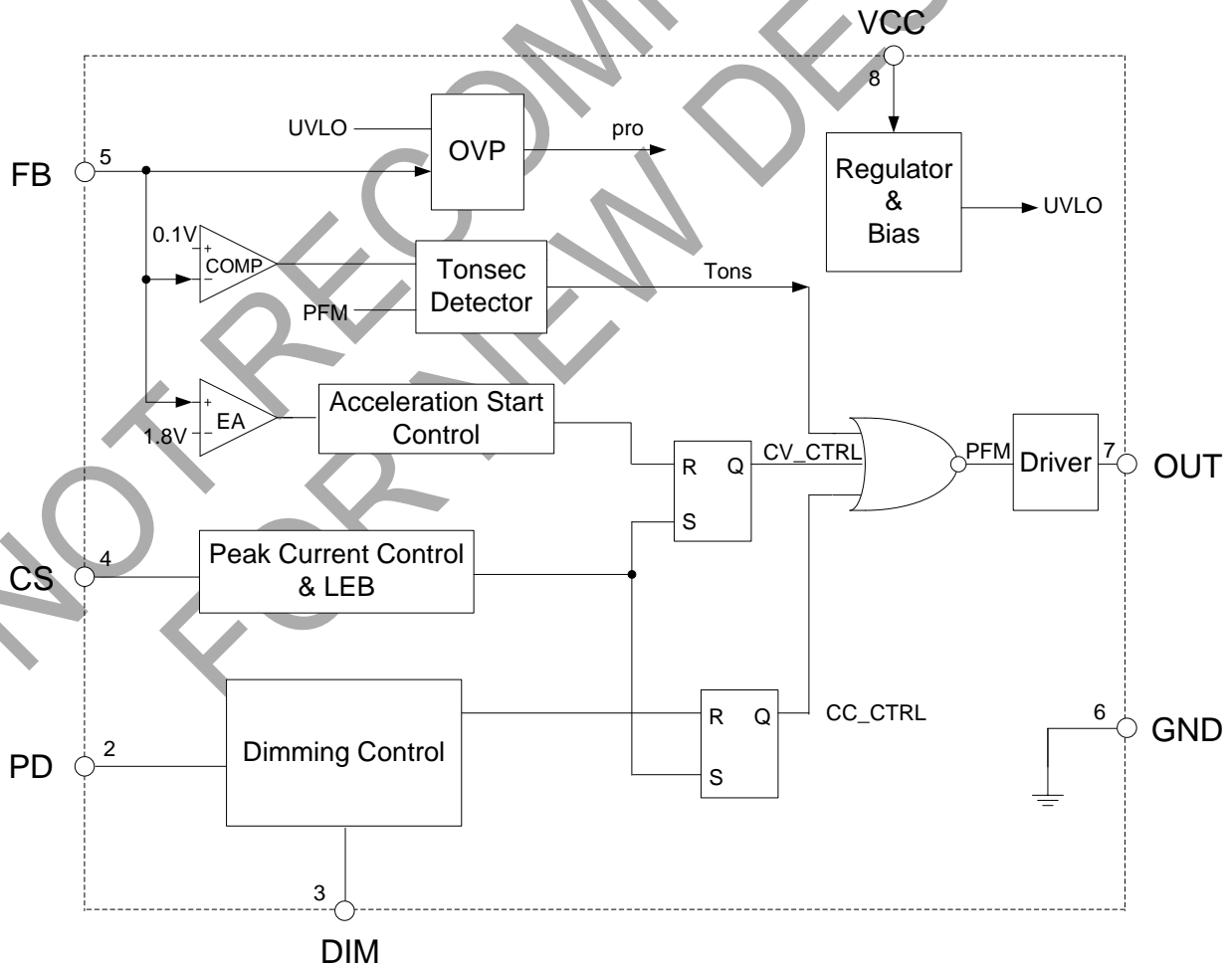

Absolute Maximum Ratings (Note 4)

Symbol	Parameter	Rating	Unit
V _{CC}	Power Supply Voltage	-0.3 to 30	V
I _{OUT}	Driver Output Current	300	mA
V _{PD} , V _{DIM} , V _{CS}	Voltage at PD, DIM, CS	-0.3 to 7	V
V _{FB}	FB Input Voltage	-40 to 10	V
T _J	Operating Junction Temperature	+150	°C
T _{STG}	Storage Temperature	-65 to +150	°C
T _{LEAD}	Lead Temperature (Soldering, 10 sec)	+300	°C
P _D	Power Dissipation at T _A = +50°C	0.65	W
θ _{JA}	Thermal Resistance (Junction to Ambient)	190	°C/W
–	ESD (Machine Model)	200	V
–	ESD (Human Body Model)	3000	V

Note 4: Stresses greater than those listed under “Absolute Maximum Ratings” may cause permanent damage to the device. These are stress ratings only, and functional operation of the device at these or any other conditions beyond those indicated under “Recommended Operating Conditions” is not implied. Exposure to “Absolute Maximum Ratings” for extended periods may affect device reliability.

Recommended Operating Conditions

Symbol	Parameter	Min	Max	Unit
V _{CC}	Power Supply Voltage	9	21	V
T _A	Ambient Temperature	-40	+105	°C

Electrical Characteristics (@V_{CC} = 15V, T_A = +25°C, unless otherwise specified.)

Symbol	Parameter	Conditions	Min	Typ	Max	Unit
UVLO Section						
V _{TH} (ST)	Start-up Threshold	–	18	19	20	V
V _{OPR} (Min)	Minimal Operating Voltage	After turn on	7	8	9	
V _{CC_OVP}	VCC OVP Voltage	–	28	32	36	
Standby Current Section						
I _{ST}	Start-up Current	V _{CC} = V _{TH} (ST)-0.5V, Before start up	–	–	100	μA
I _{CC} (Max)	Maximum Operating Current	V _{PD} = V _{DIM} = 3V	–	1500	2000	
Drive Output Section						
V _{OH}	Output High Level Voltage	I _{GD-SOURCE} = 20mA V _{CC} = 12V	10	–	–	V
V _{OL}	Output Low Level Voltage	I _{GD-SINK} = 20mA V _{CC} = 12V	–	–	1	V
t _R	Output Voltage Rise Time	C _L = 1nF	100	140	190	ns
t _F	Output Voltage Fall Time	C _L = 1nF	30	60	90	ns
V _{O-CLAMP}	Output Clamp Voltage	I _{GD-SOURCE} = 5mA V _{CC} = 20V	12	13.5	15	V
Current Sense Section						
t _{ON} (Min)	Minimum On Time	–	500	750	1000	ns
V _{SOCP}	Short Circuit Protection Voltage	–	3	4	–	V
Feedback Input Section						
I _{FB}	FB Pin Input Leakage Current	V _{FB} = 4V	–	2	8	μA
V _{FB} (ACC)	Acceleration Start Threshold	–	1.4	1.8	2.2	V
V _{FB} (OVP)	Over Voltage Protection	–	4.5	6	7.5	V
Dimming Section						
V _{IN}	PD Pin and DIM Pin Input Voltage Range	–	–	3	6	V

Performance Characteristics

Supply Current vs. Supply Voltage

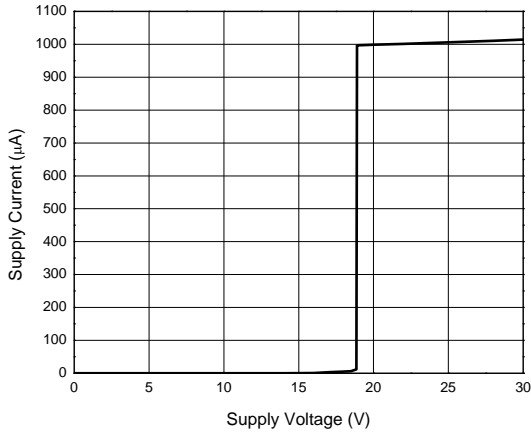

Output Clamp Voltage vs. Supply Voltage

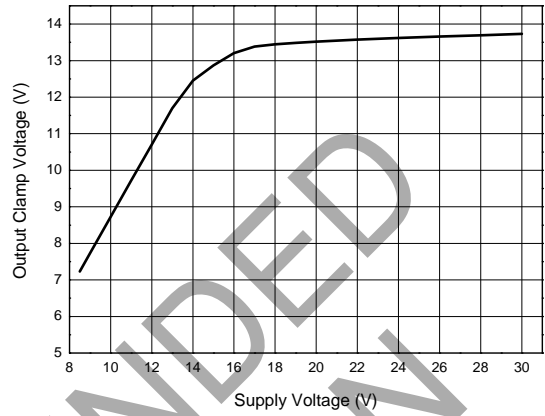

Start-up Voltage vs. Ambient Temperature

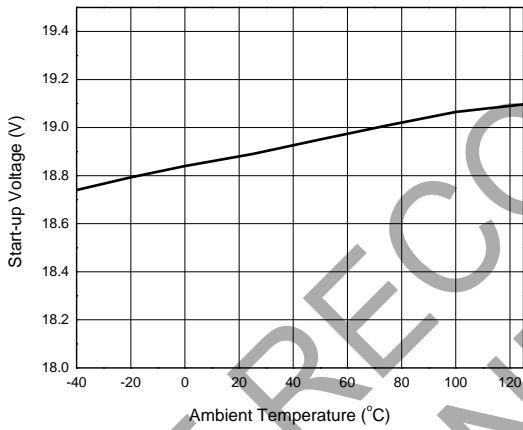

Minimal Operating Voltage vs. Ambient Temperature

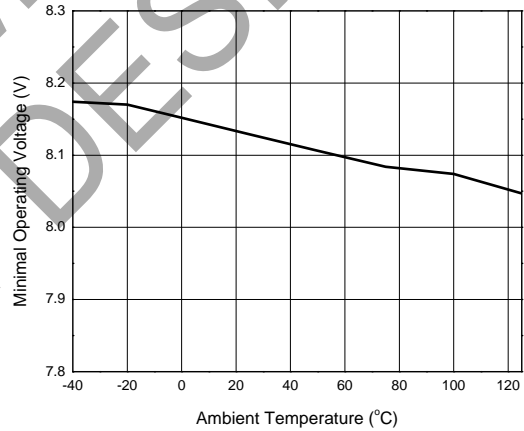

Start-up Current vs. Ambient Temperature

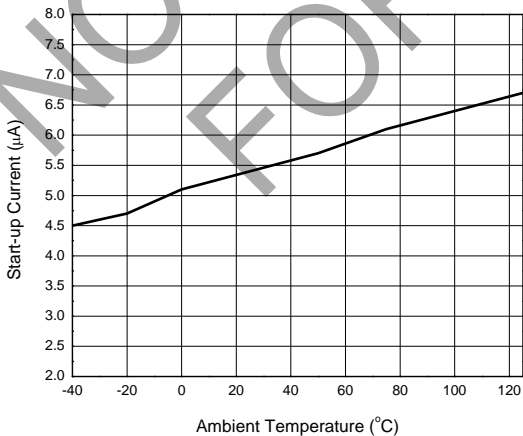

Operating Current vs. Ambient Temperature

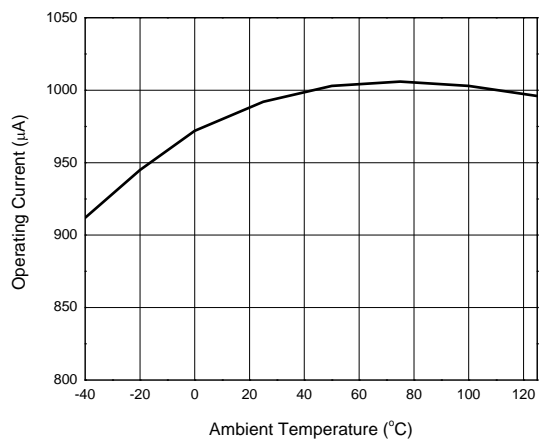

Performance Characteristics (Cont.)

FB Input Leakage Current vs. Ambient Temperature

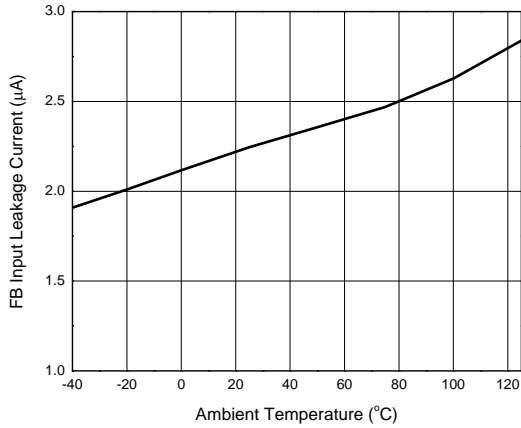

Ordering Information

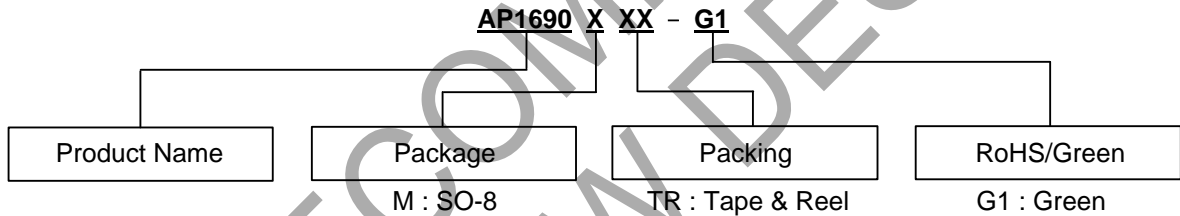

Package	Temperature Range	Part Number	Marking ID	Packing
SO-8	-40 to +105°C	AP1690MTR-G1	1690M-G1	4000/13" Tape & Reel

Marking Information

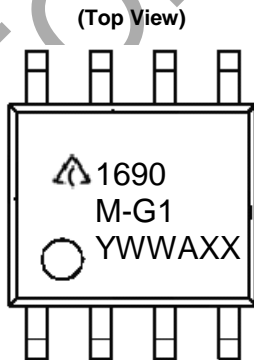

First and Second Lines: Logo and Marking ID
(See Ordering Information)
Third Line: Date Code
Y: Year
WW: Work Week of Molding
A: Assembly House Code
XX: 7th and 8th Digits of Batch No.

Package Outline Dimensions (All dimensions in mm(inch).)

(1) Package Type: SO-8

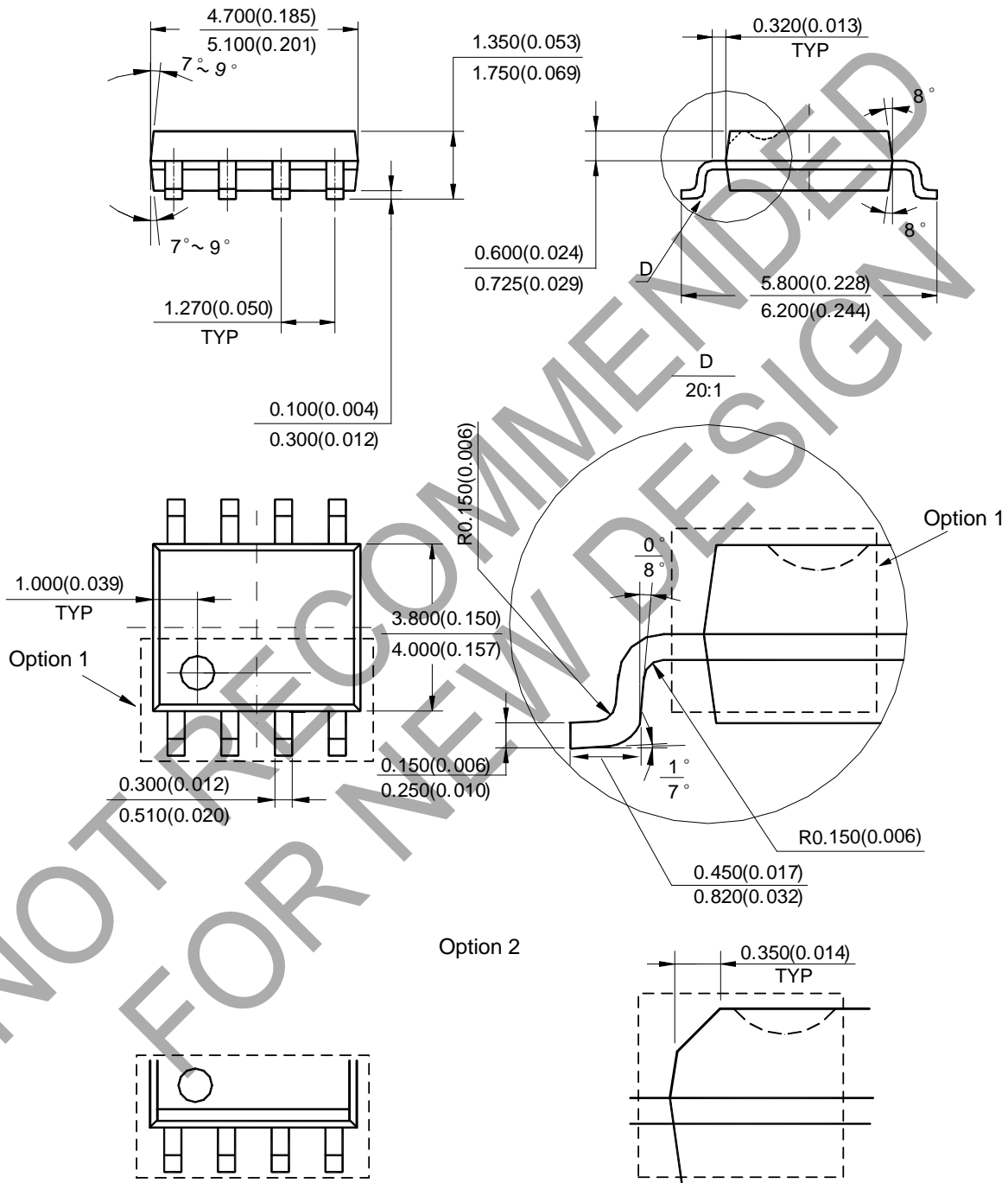

Note: Eject hole, oriented hole and mold mark is optional.

Suggested Pad Layout

(1) Package Type: SO-8

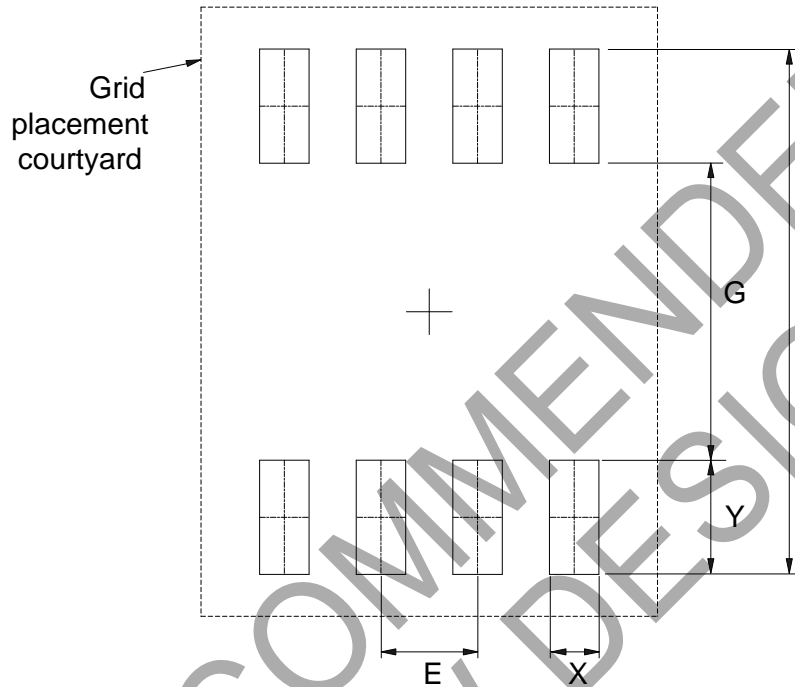

Dimensions	Z (mm)/(inch)	G (mm)/(inch)	X (mm)/(inch)	Y (mm)/(inch)	E (mm)/(inch)
Value	6.900/0.272	3.900/0.154	0.650/0.026	1.500/0.059	1.270/0.050

IMPORTANT NOTICE

DIODES INCORPORATED MAKES NO WARRANTY OF ANY KIND, EXPRESS OR IMPLIED, WITH REGARDS TO THIS DOCUMENT, INCLUDING, BUT NOT LIMITED TO, THE IMPLIED WARRANTIES OF MERCHANTABILITY AND FITNESS FOR A PARTICULAR PURPOSE (AND THEIR EQUIVALENTS UNDER THE LAWS OF ANY JURISDICTION).

Diodes Incorporated and its subsidiaries reserve the right to make modifications, enhancements, improvements, corrections or other changes without further notice to this document and any product described herein. Diodes Incorporated does not assume any liability arising out of the application or use of this document or any product described herein; neither does Diodes Incorporated convey any license under its patent or trademark rights, nor the rights of others. Any Customer or user of this document or products described herein in such applications shall assume all risks of such use and will agree to hold Diodes Incorporated and all the companies whose products are represented on Diodes Incorporated website, harmless against all damages.

Diodes Incorporated does not warrant or accept any liability whatsoever in respect of any products purchased through unauthorized sales channel. Should Customers purchase or use Diodes Incorporated products for any unintended or unauthorized application, Customers shall indemnify and hold Diodes Incorporated and its representatives harmless against all claims, damages, expenses, and attorney fees arising out of, directly or indirectly, any claim of personal injury or death associated with such unintended or unauthorized application.

Products described herein may be covered by one or more United States, international or foreign patents pending. Product names and markings noted herein may also be covered by one or more United States, international or foreign trademarks.

This document is written in English but may be translated into multiple languages for reference. Only the English version of this document is the final and determinative format released by Diodes Incorporated.

LIFE SUPPORT

Diodes Incorporated products are specifically not authorized for use as critical components in life support devices or systems without the express written approval of the Chief Executive Officer of Diodes Incorporated. As used herein:

A. Life support devices or systems are devices or systems which:

1. are intended to implant into the body, or
2. support or sustain life and whose failure to perform when properly used in accordance with instructions for use provided in the labeling can be reasonably expected to result in significant injury to the user.

B. A critical component is any component in a life support device or system whose failure to perform can be reasonably expected to cause the failure of the life support device or to affect its safety or effectiveness.

Customers represent that they have all necessary expertise in the safety and regulatory ramifications of their life support devices or systems, and acknowledge and agree that they are solely responsible for all legal, regulatory and safety-related requirements concerning their products and any use of Diodes Incorporated products in such safety-critical, life support devices or systems, notwithstanding any devices- or systems-related information or support that may be provided by Diodes Incorporated. Further, Customers must fully indemnify Diodes Incorporated and its representatives against any damages arising out of the use of Diodes Incorporated products in such safety-critical, life support devices or systems.

Copyright © 2018, Diodes Incorporated

www.diodes.com

Компания «Life Electronics» занимается поставками электронных компонентов импортного и отечественного производства от производителей и со складов крупных дистрибьюторов Европы, Америки и Азии.

С конца 2013 года компания активно расширяет линейку поставок компонентов по направлению коаксиальный кабель, кварцевые генераторы и конденсаторы (керамические, пленочные, электролитические), за счёт заключения дистрибьюторских договоров

Мы предлагаем:

- Конкурентоспособные цены и скидки постоянным клиентам.
- Специальные условия для постоянных клиентов.
- Подбор аналогов.
- Поставку компонентов в любых объемах, удовлетворяющих вашим потребностям.
- Приемлемые сроки поставки, возможна ускоренная поставка.
- Доставку товара в любую точку России и стран СНГ.
- Комплексную поставку.
- Работу по проектам и поставку образцов.
- Формирование склада под заказчика.
- Сертификаты соответствия на поставляемую продукцию (по желанию клиента).
- Тестирование поставляемой продукции.
- Поставку компонентов, требующих военную и космическую приемку.
- Входной контроль качества.
- Наличие сертификата ISO.

В составе нашей компании организован Конструкторский отдел, призванный помогать разработчикам, и инженерам.

Конструкторский отдел помогает осуществить:

- Регистрацию проекта у производителя компонентов.
- Техническую поддержку проекта.
- Защиту от снятия компонента с производства.
- Оценку стоимости проекта по компонентам.
- Изготовление тестовой платы монтаж и пусконаладочные работы.



Тел: +7 (812) 336 43 04 (многоканальный)

Email: org@lifeelectronics.ru