

THIS DRAWING IS UNPUBLISHED.

RELEASED FOR PUBLICATION

ALL RIGHTS RESERVED.

© COPYRIGHT - By -

LOC J

DIST -

REVISIONS

変更

DESCRIPTION

DATE

DWN

APVD

P

LTR

Z1 REVISED PER ECR-12-007692

25APR12

LL

FM



表1 (TABLE 1)

No	名称 (NAME)	材料 (MATERIAL)
①	ヘッダーハウジング (HEADER HOUSING)	PBT ガラス強化 UL94V-0 (PBT GLASS FILLED UL94V-0)
②	ポスト コンタクト (POST CONTACT)	黄銅錫めっき仕上げ (POST TIN · BRASS)

- 注記:
- 1. 嵌合相手側製品型番: □-1123722-□
  - 2. 取付け基板寸法: FIG.1 参照
  - 3. 適用基板厚: 1.6t
  - 4. 7.92mmピッチタイプ (FIG.2参照)

- NOTES:
- 1. MATING CONN P/N: □-1123722-□
  - 2. APPLICABLE P.C.B LAY OUT: SEE FIG.1
  - 3. APPLICABLE P.C.B THICKNESS: 1.6t
  - 4. TYPE OF 7.92mmPITCH(SEE FIG.2)
  - 5. OBSOLETE PARTS: OBSOLETE CIS STREAMLINING PER D.RENAUD/D.SINISI

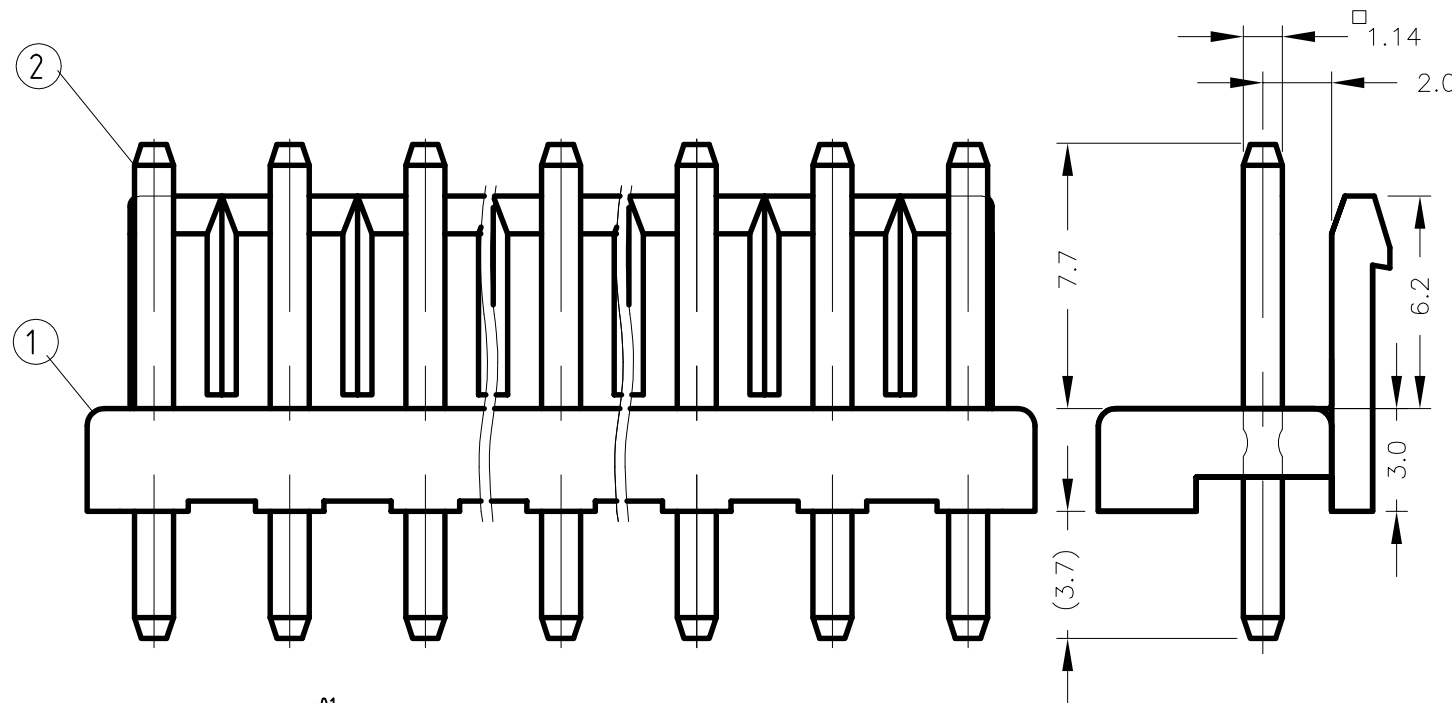
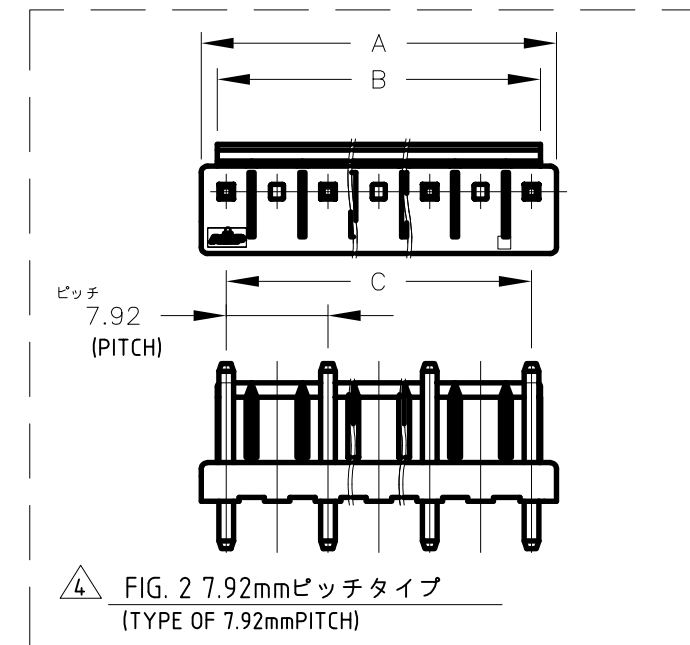
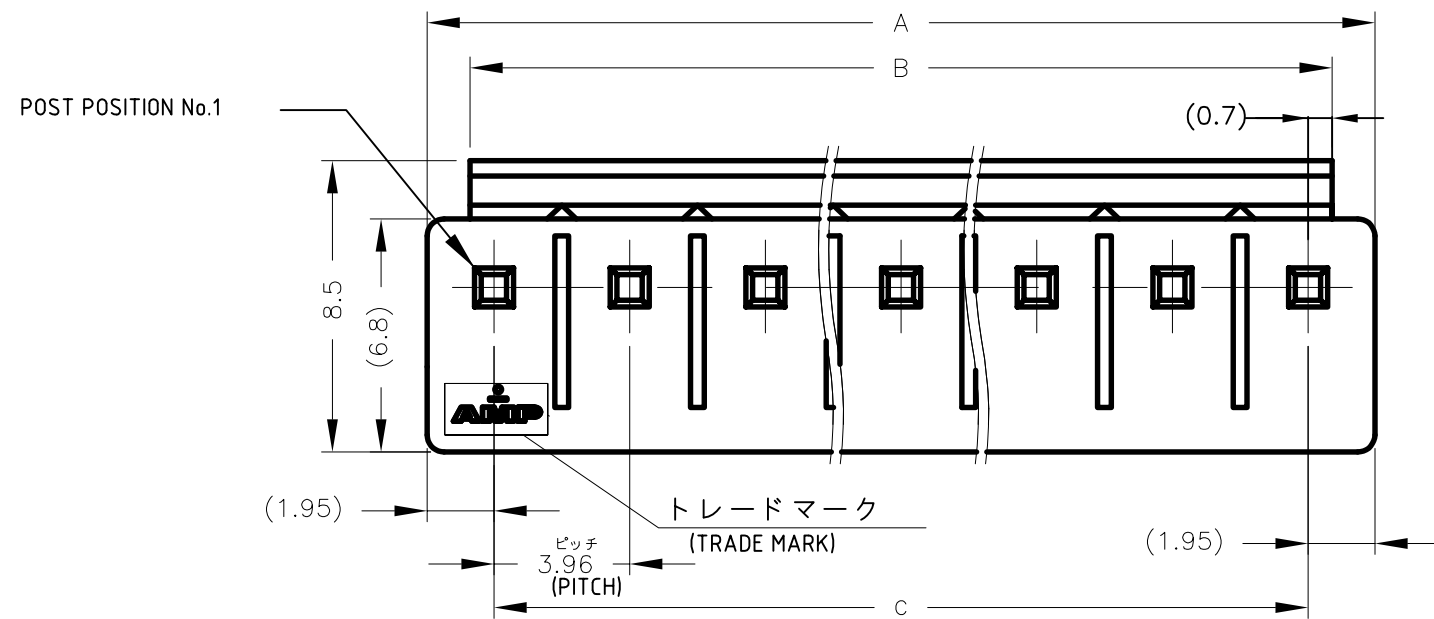
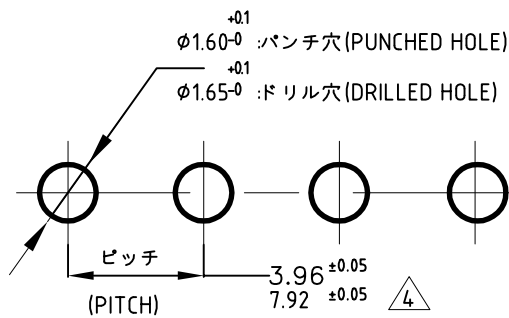

△ FIG. 1

THIS DRAWING IS A CONTROLLED DOCUMENT.

DIMENSIONS: 単位: 耗 mm

TOLERANCES UNLESS OTHERWISE SPECIFIED: 一般公差

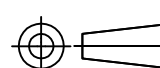

- 0 PLC 5<sup>></sup> ± 0.3
- 1 PLC 5 < ± 0.4
- 2 PLC ±
- 3 PLC ±
- 4 PLC ±
- ANGLES ±
- FINISH 仕上 //

MATERIAL 材料 SEE TABLE1

DWN 13MAR'01

N.YAMASAKI

CHK 13MAR'01

M.SHINDO

APVD 13MAR'01

Y.KASHIWA

PRODUCT SPEC 製品規格 108-5609

APPLICATION SPEC 取付適用規格 //

WEIGHT //

CUSTOMER DRAWING



NAME 3.96(7.92)MM PITCH ECONOMY POWER(EP) CONN HEADER ASSY

3.96(7.92)mmピッチ エコノミーパワー(EP)コネクタ ヘッダーアッセンブリ

SIZE A3 CAGE CODE 00779 DRAWING NO. 番号 G=1123723 RESTRICTED TO -

SCALE 尺度 //

SHEET 1 of 3 REV Z1

THIS DRAWING IS UNPUBLISHED.

RELEASED FOR PUBLICATION

ALL RIGHTS RESERVED.

© COPYRIGHT - By -

LOC J DIST -

REVISIONS

変更

DESCRIPTION

DATE

DWN

APVD

SEE SHEET 1

注
1) O : ポストあり (WITH POST)
2) X : ポスト抜き (WITHOUT POST)

Table with columns for Post Position (1-11), Dimension (C, B, A), Housing Color, Pos, and P/N. Includes color options like Green, Black, Red, Blue, Yellow, Orange, Pink, Gray.

Table with columns for Post Position (1-11), Dimension (C, B, A), Housing Color, Pos, and P/N. Includes color options like Green, Black, Red, Blue, Yellow, Orange, Pink, Gray.

Table with columns for Post Position (1-11), Dimension (C, B, A), Housing Color, Pos, and P/N. Includes color options like Green, Black, Red, Blue, Yellow, Orange, Pink, Gray.

THIS DRAWING IS A CONTROLLED DOCUMENT.

Table with DIMENSIONS (mm), TOLERANCES (PLC, ANGLES), MATERIAL (SEE TABLE 1), and FINISH (仕上).

Table with DWN (N.YAMASAKI), CHK (M.SHINDO), APVD (Y.KASHIWA), PRODUCT SPEC (108-5609), APPLICATION SPEC, WEIGHT, and CUSTOMER DRAWING.

Table with NAME (3.96(7.92)MM PITCH ECONOMY POWER(EP) CONN HEADER ASSY), SIZE (3.96(7.92)mmピッチ), CAGE CODE (A300779), DRAWING NO (1123723), RESTRICTED TO, SCALE (1:1), SHEET (2 of 3), and REV (Z1).



P	LTR	DESCRIPTION	DATE	DWN	APVD
-	-	SEE SHEET 1	-	-	-

1	2	3	4	5	6	7	8	9	10	11	C	B	A	ハウジング色調 (HOUSING COLOR)	極数 (POS)	型番 (P/N)
○	○	○	○	○	○	○	○	○	○	○	35.64	37.04	39.54	自然色(NATURAL)	9	8-1565036-0
○	×	×	○	○	○	○	○	○	○	○	31.68	33.08	35.58		8	7-1612911-8 7-1565036-0
○	○	○	×	○	○	○	○	○	○	○	27.72	29.12	31.62		7	6-1565036-0 5-1565036-0
○	×	×	×	○	○	○	○	○	○	○	35.64	37.04	39.54		6	7-1612911-6 7-1612911-0 7-1565037-6 4-1565036-0 3-1565036-0 2-1565036-0 1-1565036-0
○	×	○	○	○	×	○	○	○	○	○	31.68	33.08	35.58			8-1473978-6 7-1473978-6 7-1123724-6
○	×	○	○	○	○	○	○	○	○	○	27.72	29.12	31.62			9-1565036-1 7-1473059-5 8-1565036-1 7-1565036-1
○	○	○	○	○	○	○	○	○	○	○	23.76	25.16	27.66			6-1565036-1 5-1565036-1 4-1565036-1 3-1565036-1
○	○	○	○	○	○	○	○	○	○	○	31.68	33.08	35.58			7-1717011-5 8-1565035-5 7-1123724-5
○	○	○	○	○	○	○	○	○	○	○	19.80	21.20	23.70		4	3-1717011-1 1-1565036-1 2-1565036-1 2-1717011-1 1-1717011-1 9-1565035-4 8-1565035-4 7-1565035-4 7-1565606-4 7-1123724-1
○	○	○	○	○	○	○	○	○	○	○	19.80	21.20	23.70			8-1717011-3 7-1717011-3 7-1565034-3 7-1473058-3 4-1473059-1 3-1473059-1 2-1473059-1 1-1473059-1 7-1123724-3
○	○	○	○	○	○	○	○	○	○	○	15.84	17.24	19.74			7-1565033-2 8-1473057-2 7-1473057-2 7-1123724-2
○	○	○	○	○	○	○	○	○	○	○	23.76	25.16	27.66	11		8-1123723-1
○	○	○	○	○	○	○	○	○	○	○	15.84	17.24	19.74	9		7- -1
○	○	○	○	○	○	○	○	○	○	○	35.64	37.04	39.54	10		7- -0
○	○	○	○	○	○	○	○	○	○	○	31.68	33.08	35.58	9		7- -9
○	○	○	○	○	○	○	○	○	○	○	27.72	29.12	31.62	8		7- -8
○	○	○	○	○	○	○	○	○	○	○	23.76	25.16	27.66	7		7- -7
○	○	○	○	○	○	○	○	○	○	○	19.80	21.20	23.70	6		7- -6
○	○	○	○	○	○	○	○	○	○	○	15.84	17.24	19.74	5		7- -5
○	○	○	○	○	○	○	○	○	○	○	11.88	13.28	15.78	4	7- -4	
○	○	○	○	○	○	○	○	○	○	○	7.92	9.32	11.82	3	7- -3	
○	○	○	○	○	○	○	○	○	○	○	3.96	5.36	7.86	2	7-1123723-2	
1	2	3	4	5	6	7	8	9	10	11	C	B	A			
ポスト位置(POST POSITION)											寸法(DIMENSION)					

注

- 1) ○ : ポストあり (WITH POST)
- 2) × : ポスト抜き (WITHOUT POST)
- 3) ALL THE PARTS IN SHEET 3 OF 3 MEET IEC 60335-1 (GWT GLOW WIRE TEST 750 DEGREE SPEC)

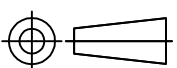
THIS DRAWING IS A CONTROLLED DOCUMENT.		DWN	13MAR'01	 <b>TE</b> Connectivity
DIMENSIONS: 単位: 耗 mm		CHK	13MAR'01	
 TOLERANCES UNLESS OTHERWISE SPECIFIED: 一般公差 0 PLC ± 0.3 1 PLC ± 0.4 2 PLC ± 3 PLC ± 4 PLC ± ANGLES ±		APVD	13MAR'01	
MATERIAL 材料 SEE TABLE1		FINISH 仕上	WEIGHT	NAME 名称 3.96(7.92)MM PITCH ECONOMY POWER(EP) CONN HEADER ASSY  SIZE A3 CAGE CODE 00779 DRAWING NO 番号 G=1123723 RESTRICTED TO - SCALE 尺度 - SHEET 3 of 3 REV Z1
CUSTOMER DRAWING				

Компания «Life Electronics» занимается поставками электронных компонентов импортного и отечественного производства от производителей и со складов крупных дистрибьюторов Европы, Америки и Азии.

С конца 2013 года компания активно расширяет линейку поставок компонентов по направлению коаксиальный кабель, кварцевые генераторы и конденсаторы (керамические, пленочные, электролитические), за счёт заключения дистрибьюторских договоров

Мы предлагаем:

- Конкуренеспособные цены и скидки постоянным клиентам.
- Специальные условия для постоянных клиентов.
- Подбор аналогов.
- Поставку компонентов в любых объемах, удовлетворяющих вашим потребностям.
- Приемлемые сроки поставки, возможна ускоренная поставка.
- Доставку товара в любую точку России и стран СНГ.
- Комплексную поставку.
- Работу по проектам и поставку образцов.
- Формирование склада под заказчика.
- Сертификаты соответствия на поставляемую продукцию (по желанию клиента).
- Тестирование поставляемой продукции.
- Поставку компонентов, требующих военную и космическую приемку.
- Входной контроль качества.
- Наличие сертификата ISO.

В составе нашей компании организован Конструкторский отдел, призванный помогать разработчикам, и инженерам.

Конструкторский отдел помогает осуществить:

- Регистрацию проекта у производителя компонентов.
- Техническую поддержку проекта.
- Защиту от снятия компонента с производства.
- Оценку стоимости проекта по компонентам.
- Изготовление тестовой платы монтаж и пусконаладочные работы.



Тел: +7 (812) 336 43 04 (многоканальный)  
Email: [org@lifeelectronics.ru](mailto:org@lifeelectronics.ru)