

N-Channel Power MOSFET

40V, 121A, 3.3mΩ

FEATURES

- Low $R_{DS(ON)}$ to minimize conductive losses
- Low gate charge for fast power switching
- 100% UIS and R_g tested.
- 175°C Operating Junction Temperature
- Compliant to RoHS directive 2011/65/EU and in accordance to WEEE 2002/96/EC
- Halogen-free according to IEC 61249-2-21

KEY PERFORMANCE PARAMETERS

| PARAMETER | VALUE | UNIT | |
|--------------------|----------------|------|----|
| V_{DS} | 40 | V | |
| $R_{DS(on)}$ (max) | $V_{GS} = 10V$ | 3.3 | mΩ |
| Q_g | 77 | nC | |

APPLICATIONS

- BLDC Motor Control
- Battery Power Management
- DC-DC converter
- Secondary Synchronous Rectification

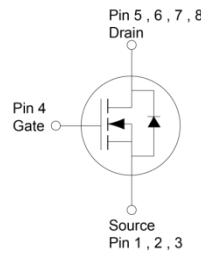
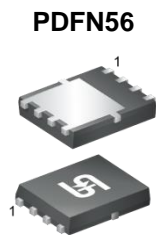

Note: MSL 1 (Moisture Sensitivity Level) per J-STD-020

| ABSOLUTE MAXIMUM RATINGS ($T_A = 25^\circ\text{C}$ unless otherwise noted) | | | |
|---|----------------|---------------------------|------------------|
| PARAMETER | SYMBOL | LIMIT | UNIT |
| Drain-Source Voltage | V_{DS} | 40 | V |
| Gate-Source Voltage | V_{GS} | ± 20 | V |
| Continuous Drain Current (Note 1) | I_D | $T_C = 25^\circ\text{C}$ | 121 |
| | | $T_A = 25^\circ\text{C}$ | 21 |
| Pulsed Drain Current | I_{DM} | 484 | A |
| Single Pulse Avalanche Current (Note 2) | I_{AS} | 36 | A |
| Single Pulse Avalanche Energy (Note 2) | E_{AS} | 194 | mJ |
| Total Power Dissipation | P_D | $T_C = 25^\circ\text{C}$ | 107 |
| | | $T_C = 125^\circ\text{C}$ | 36 |
| Total Power Dissipation | P_D | $T_A = 25^\circ\text{C}$ | 3.1 |
| | | $T_A = 125^\circ\text{C}$ | 1 |
| Operating Junction and Storage Temperature Range | T_J, T_{STG} | - 55 to +175 | $^\circ\text{C}$ |

| THERMAL PERFORMANCE | | | |
|--|-----------------|-------|--------------------|
| PARAMETER | SYMBOL | LIMIT | UNIT |
| Junction to Case Thermal Resistance | $R_{\theta JC}$ | 1.4 | $^\circ\text{C/W}$ |
| Junction to Ambient Thermal Resistance | $R_{\theta JA}$ | 48 | $^\circ\text{C/W}$ |

Thermal Performance Note: $R_{\theta JA}$ is the sum of the junction-to-case and case-to-ambient thermal resistances. The case-thermal reference is defined at the solder mounting surface of the drain pins. $R_{\theta JA}$ is guaranteed by design while $R_{\theta CA}$ is determined by the user's board design. The $R_{\theta JA}$ limit presented here is based on mounting on a 1 in² pad of 2 oz copper.

| ELECTRICAL SPECIFICATIONS ($T_A = 25^\circ\text{C}$ unless otherwise noted) | | | | | | |
|---|---|--------------|-----|------|-----------|------------|
| PARAMETER | CONDITIONS | SYMBOL | MIN | TYP | MAX | UNIT |
| Static | | | | | | |
| Drain-Source Breakdown Voltage | $V_{GS} = 0V, I_D = 250\mu A$ | BV_{DSS} | 40 | -- | -- | V |
| Gate Threshold Voltage | $V_{GS} = V_{DS}, I_D = 250\mu A$ | $V_{GS(TH)}$ | 2 | 2.9 | 4 | V |
| Gate-Source Leakage Current | $V_{GS} = \pm 20V, V_{DS} = 0V$ | I_{GSS} | -- | -- | ± 100 | nA |
| Drain-Source Leakage Current | $V_{GS} = 0V, V_{DS} = 40V$ | I_{DSS} | -- | -- | 1 | μA |
| | $V_{GS} = 0V, V_{DS} = 40V$ $T_J = 125^\circ\text{C}$ | | -- | -- | 100 | |
| Drain-Source On-State Resistance (Note 3) | $V_{GS} = 10V, I_D = 21A$ | $R_{DS(on)}$ | -- | 2.4 | 3.3 | m Ω |
| Forward Transconductance (Note 3) | $V_{DS} = 10V, I_D = 21A$ | g_{fs} | -- | 64 | -- | S |
| Dynamic (Note 4) | | | | | | |
| Total Gate Charge | $V_{GS} = 10V, V_{DS} = 20V,$ $I_D = 21A$ | Q_g | -- | 77 | - | nC |
| Gate-Source Charge | | Q_{gs} | -- | 23 | -- | |
| Gate-Drain Charge | | Q_{gd} | -- | 19 | -- | |
| Input Capacitance | $V_{GS} = 0V, V_{DS} = 20V$ $f = 1.0\text{MHz}$ | C_{iss} | -- | 5022 | -- | pF |
| Output Capacitance | | C_{oss} | -- | 484 | -- | |
| Reverse Transfer Capacitance | | C_{rss} | -- | 250 | -- | |
| Gate Resistance | $f = 1.0\text{MHz}$ | R_g | 0.5 | 1.5 | 3 | Ω |
| Switching (Note 4) | | | | | | |
| Turn-On Delay Time | $V_{GS} = 10V, V_{DS} = 20V,$ $I_D = 21A, R_G = 2\Omega$ | $t_{d(on)}$ | -- | 7 | -- | ns |
| Turn-On Rise Time | | t_r | -- | 22 | -- | |
| Turn-Off Delay Time | | $t_{d(off)}$ | -- | 35 | -- | |
| Turn-Off Fall Time | | t_f | -- | 17 | -- | |
| Source-Drain Diode | | | | | | |
| Forward Voltage (Note 3) | $V_{GS} = 0V, I_S = 21A$ | V_{SD} | -- | -- | 1 | V |
| Reverse Recovery Time | $I_S = 21A,$ $dI/dt = 100A/\mu s$ | t_{rr} | -- | 26 | -- | ns |
| Reverse Recovery Charge | | Q_{rr} | -- | 19 | -- | nC |

Notes:

1. Silicon limited current only.
2. $L = 0.3\text{mH}, V_{GS} = 10V, V_{DD} = 25V, R_G = 25\Omega, I_{AS} = 36A,$ Starting $T_J = 25^\circ\text{C}$
3. Pulse test: Pulse Width $\leq 300\mu s,$ duty cycle $\leq 2\%$.
4. Switching time is essentially independent of operating temperature.

ORDERING INFORMATION

| PART NO. | PACKAGE | PACKING |
|------------------|---------|---------------------|
| TSM033NB04CR RLG | PDFN56 | 2,500pcs / 13" Reel |

CHARACTERISTICS CURVES

($T_A = 25^\circ\text{C}$ unless otherwise noted)

Output Characteristics

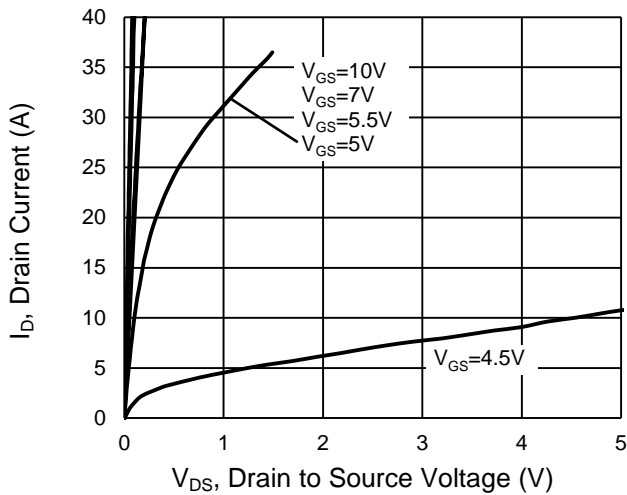

Transfer Characteristics

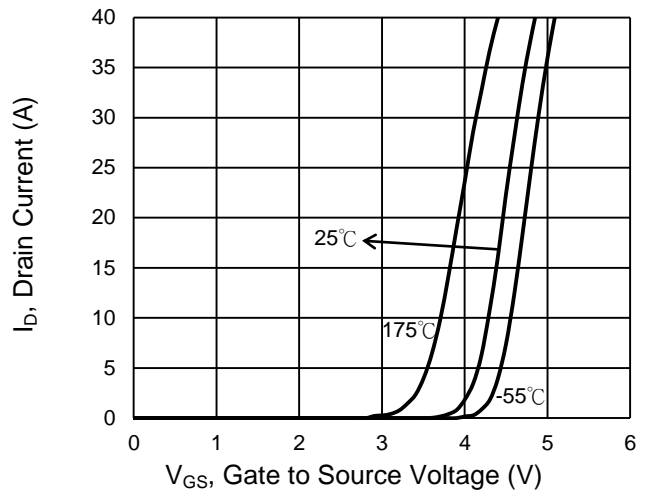

On-Resistance vs. Drain Current

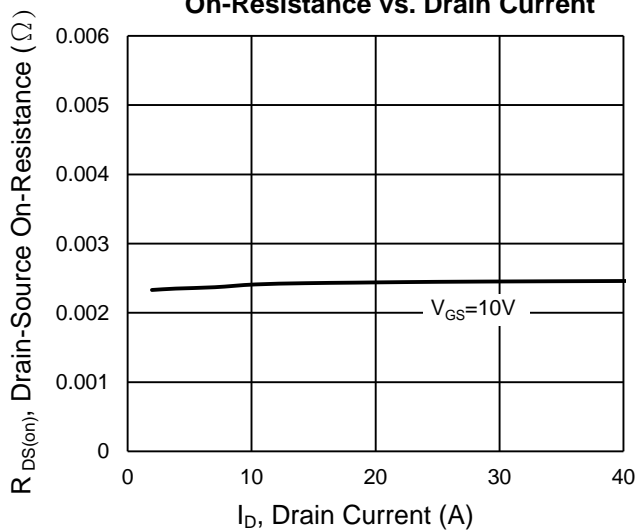

Gate-Source Voltage vs. Gate Charge

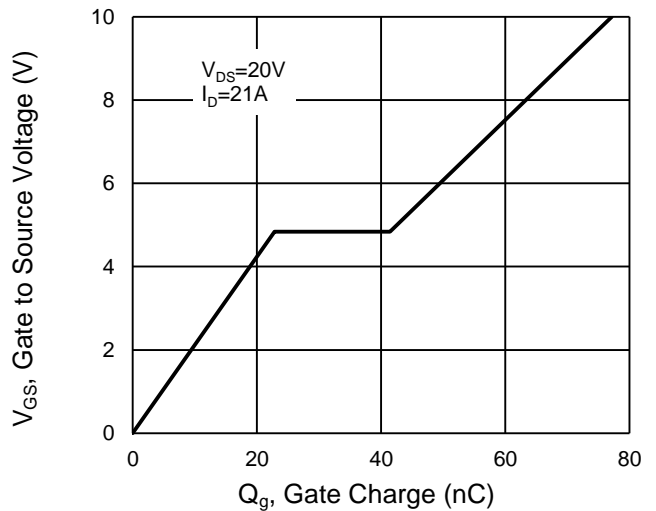

On-Resistance vs. Junction Temperature

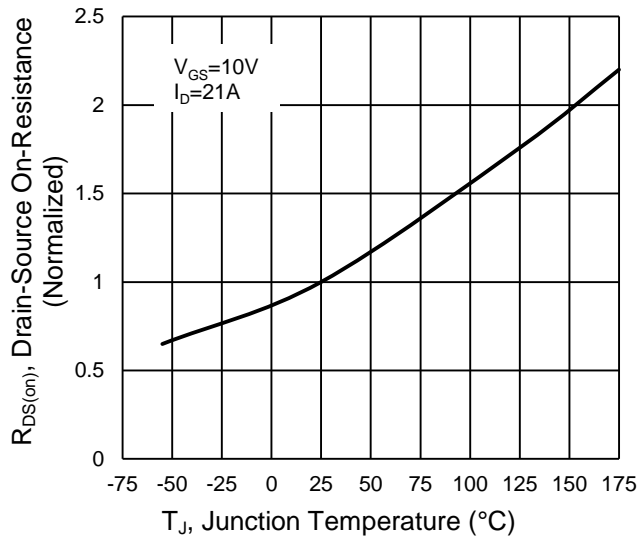

On-Resistance vs. Gate-Source Voltage

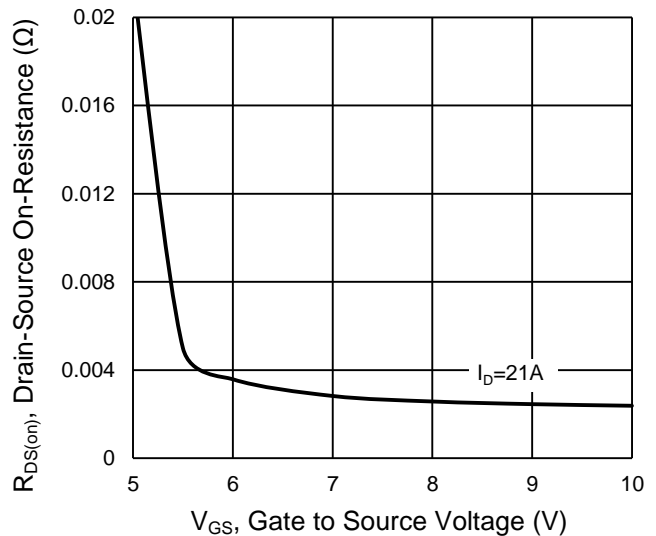

CHARACTERISTICS CURVES

($T_A = 25^\circ\text{C}$ unless otherwise noted)

Capacitance vs. Drain-Source Voltage

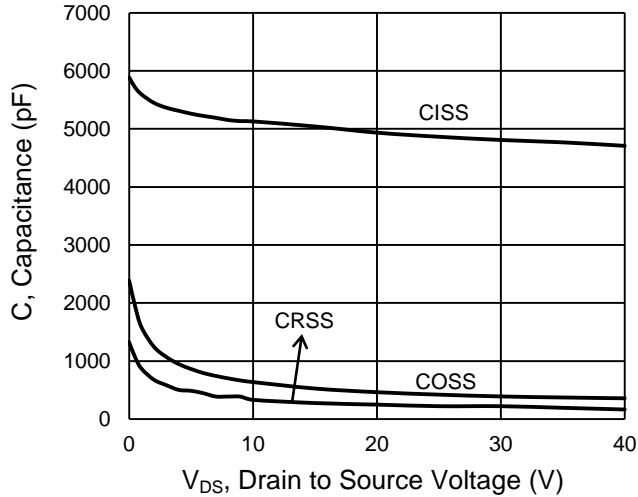

BV_{DSS} vs. Junction Temperature

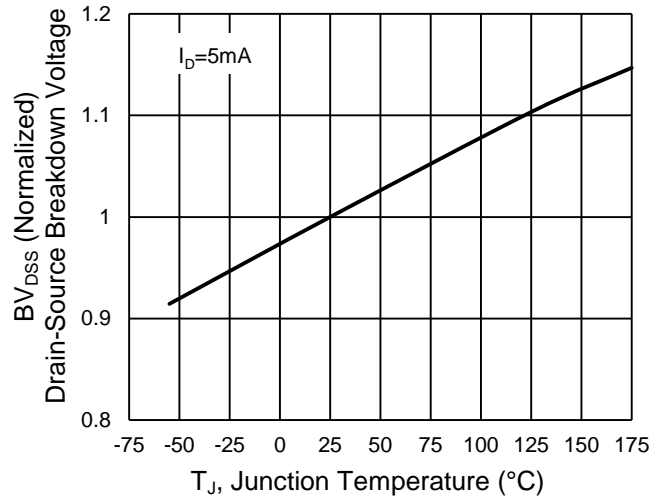

Maximum Safe Operating Area, Junction-to-Case

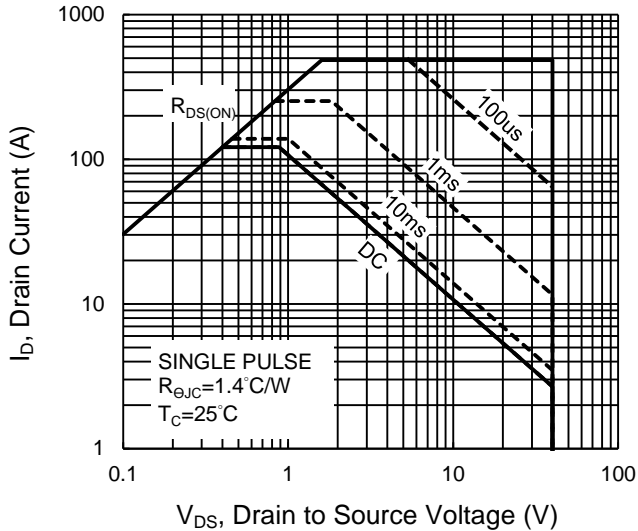

Source-Drain Diode Forward Current vs. Voltage

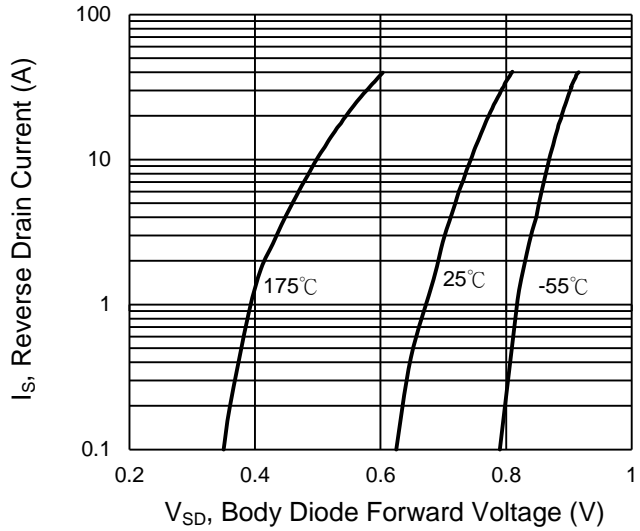

Normalized Thermal Transient Impedance, Junction-to-Case

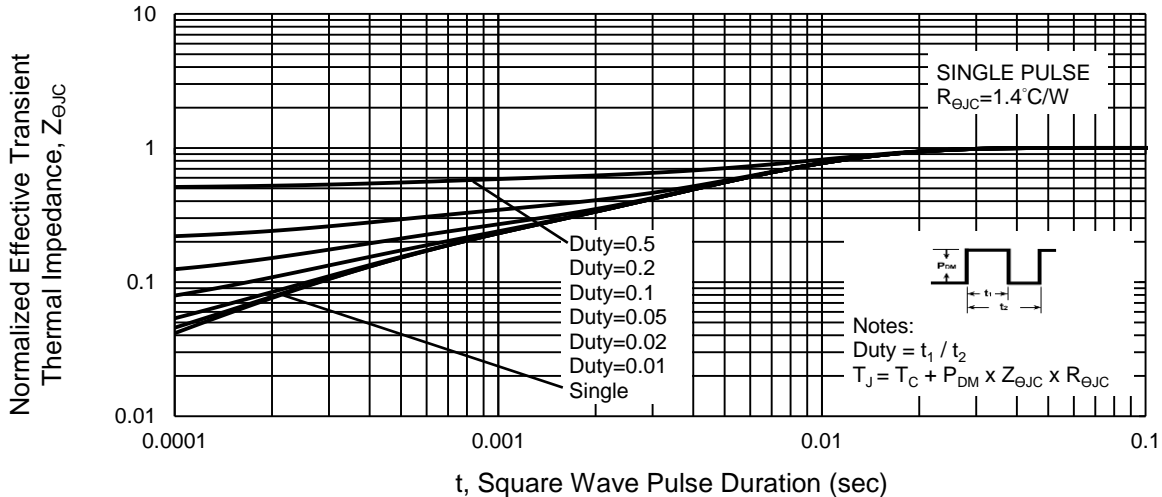

PACKAGE OUTLINE DIMENSIONS (Unit: Millimeters)

PDFN56

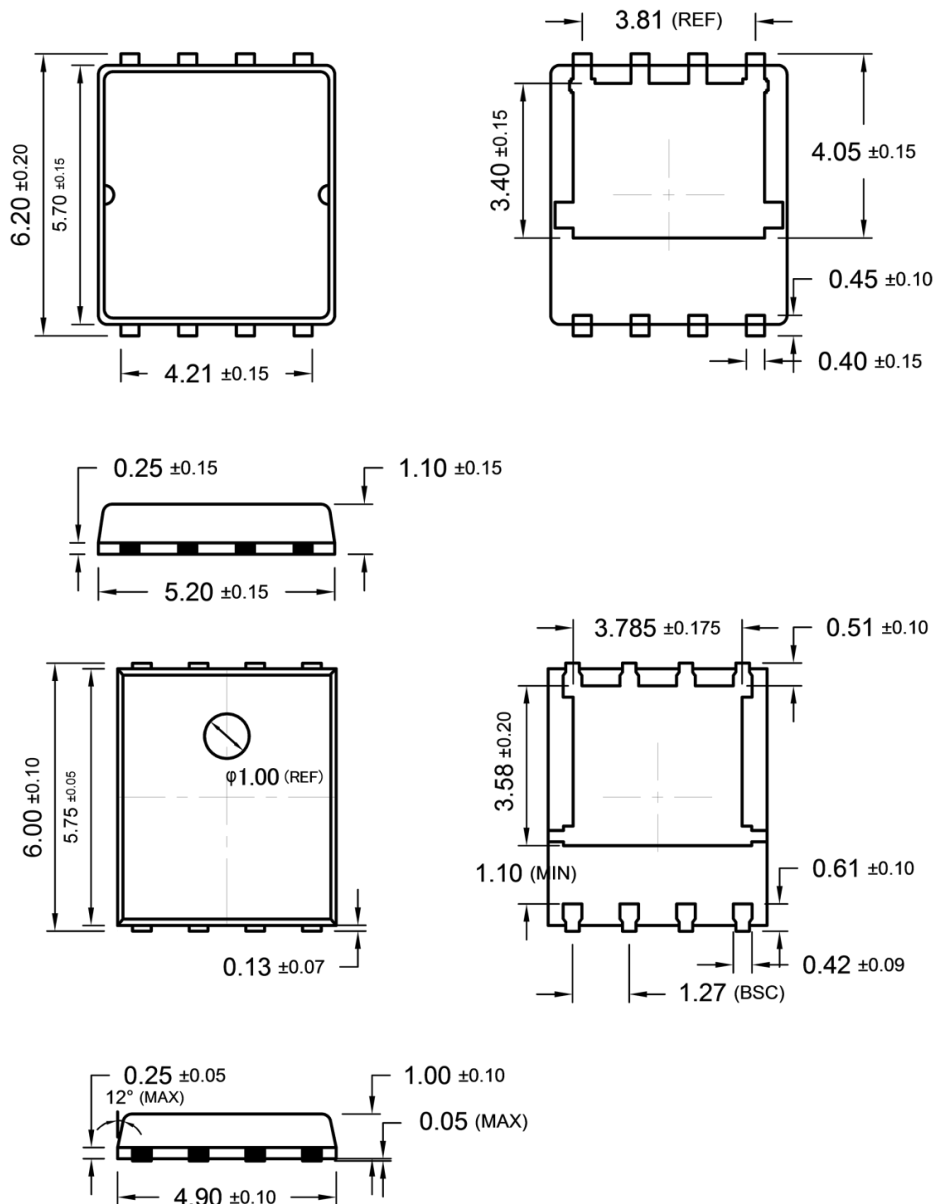

SUGGESTED PAD LAYOUT (Unit: Millimeters)



MARKING DIAGRAM



- G** = Halogen Free
- Y** = Year Code
- WW** = Week Code (01~52)
- F** = Factory Code

Notice

Specifications of the products displayed herein are subject to change without notice. TSC or anyone on its behalf, assumes no responsibility or liability for any errors or inaccuracies.

Information contained herein is intended to provide a product description only. No license, express or implied, to any intellectual property rights is granted by this document. Except as provided in TSC's terms and conditions of sale for such products, TSC assumes no liability whatsoever, and disclaims any express or implied warranty, relating to sale and/or use of TSC products including liability or warranties relating to fitness for a particular purpose, merchantability, or infringement of any patent, copyright, or other intellectual property right.

The products shown herein are not designed for use in medical, life-saving, or life-sustaining applications. Customers using or selling these products for use in such applications do so at their own risk and agree to fully indemnify TSC for any damages resulting from such improper use or sale.

Компания «Life Electronics» занимается поставками электронных компонентов импортного и отечественного производства от производителей и со складов крупных дистрибьюторов Европы, Америки и Азии.

С конца 2013 года компания активно расширяет линейку поставок компонентов по направлению коаксиальный кабель, кварцевые генераторы и конденсаторы (керамические, пленочные, электролитические), за счёт заключения дистрибьюторских договоров

Мы предлагаем:

- Конкурентоспособные цены и скидки постоянным клиентам.
- Специальные условия для постоянных клиентов.
- Подбор аналогов.
- Поставку компонентов в любых объемах, удовлетворяющих вашим потребностям.
- Приемлемые сроки поставки, возможна ускоренная поставка.
- Доставку товара в любую точку России и стран СНГ.
- Комплексную поставку.
- Работу по проектам и поставку образцов.
- Формирование склада под заказчика.
- Сертификаты соответствия на поставляемую продукцию (по желанию клиента).
- Тестирование поставляемой продукции.
- Поставку компонентов, требующих военную и космическую приемку.
- Входной контроль качества.
- Наличие сертификата ISO.

В составе нашей компании организован Конструкторский отдел, призванный помогать разработчикам, и инженерам.

Конструкторский отдел помогает осуществить:

- Регистрацию проекта у производителя компонентов.
- Техническую поддержку проекта.
- Защиту от снятия компонента с производства.
- Оценку стоимости проекта по компонентам.
- Изготовление тестовой платы монтаж и пусконаладочные работы.



Тел: +7 (812) 336 43 04 (многоканальный)

Email: org@lifeelectronics.ru