



# CY3280-MBR CapSense<sup>®</sup> Express<sup>™</sup> with SmartSense<sup>™</sup> Auto-Tuning Kit Guide

Doc. # 001-64772 Rev. \*\*

Cypress Semiconductor  
198 Champion Court  
San Jose, CA 95134-1709  
Phone (USA): 800.858.1810  
Phone (Intl): 408.943.2600  
<http://www.cypress.com>

**Copyrights**

© Cypress Semiconductor Corporation, 2010. The information contained herein is subject to change without notice. Cypress Semiconductor Corporation assumes no responsibility for the use of any circuitry other than circuitry embodied in a Cypress product. Nor does it convey or imply any license under patent or other rights. Cypress products are not warranted nor intended to be used for medical, life support, life saving, critical control or safety applications, unless pursuant to an express written agreement with Cypress. Furthermore, Cypress does not authorize its products for use as critical components in life-support systems where a malfunction or failure may reasonably be expected to result in significant injury to the user. The inclusion of Cypress products in life-support systems application implies that the manufacturer assumes all risk of such use and in doing so indemnifies Cypress against all charges.

Any Source Code (software and/or firmware) is owned by Cypress Semiconductor Corporation (Cypress) and is protected by and subject to worldwide patent protection (United States and foreign), United States copyright laws and international treaty provisions. Cypress hereby grants to licensee a personal, non-exclusive, non-transferable license to copy, use, modify, create derivative works of, and compile the Cypress Source Code and derivative works for the sole purpose of creating custom software and or firmware in support of licensee product to be used only in conjunction with a Cypress integrated circuit as specified in the applicable agreement. Any reproduction, modification, translation, compilation, or representation of this Source Code except as specified above is prohibited without the express written permission of Cypress.

Disclaimer: CYPRESS MAKES NO WARRANTY OF ANY KIND, EXPRESS OR IMPLIED, WITH REGARD TO THIS MATERIAL, INCLUDING, BUT NOT LIMITED TO, THE IMPLIED WARRANTIES OF MERCHANTABILITY AND FITNESS FOR A PARTICULAR PURPOSE. Cypress reserves the right to make changes without further notice to the materials described herein. Cypress does not assume any liability arising out of the application or use of any product or circuit described herein. Cypress does not authorize its products for use as critical components in life-support systems where a malfunction or failure may reasonably be expected to result in significant injury to the user. The inclusion of Cypress' product in a life-support systems application implies that the manufacturer assumes all risk of such use and in doing so indemnifies Cypress against all charges.

Use may be limited by and subject to the applicable Cypress software license agreement.

PSoC and CapSense are registered trademarks of Cypress Semiconductor Corporation. PSoC Designe, SmartSense, and CapSense Express are trademarks of Cypress Semiconductor Corporation. All other products and company names mentioned in this document may be the trademarks of their respective holders.

Purchase of I2C components from Cypress or one of its sublicensed Associated Companies conveys a license under the Philips I2C Patent Rights to use these components in an I2C system, provided that the system conforms to the I2C Standard Specification as defined by Philips. As from October 1st, 2006 Philips Semiconductors has a new trade name - NXP Semiconductors.

**Flash Code Protection**

Cypress products meet the specifications contained in their particular Cypress PSoC Data Sheets. Cypress believes that its family of PSoC products is one of the most secure families of its kind on the market today, regardless of how they are used. There may be methods, unknown to Cypress, that can breach the code protection features. Any of these methods, to our knowledge, would be dishonest and possibly illegal. Neither Cypress nor any other semiconductor manufacturer can guarantee the security of their code. Code protection does not mean that we are guaranteeing the product as "unbreakable."

Cypress is willing to work with the customer who is concerned about the integrity of their code. Code protection is constantly evolving. We at Cypress are committed to continuously improving the code protection features of our products.

# Contents



<b>1. Introduction</b>	<b>5</b>
1.1 Kit Contents .....	5
1.2 Installation.....	5
1.3 Features of CY3280-MBR Kit Board.....	5
1.4 Factory Default Configuration .....	5
1.5 Document Revision History .....	6
1.6 Documentation Conventions .....	6
<b>2. Kit Operation</b>	<b>7</b>
2.1 Power Supply.....	8
2.2 System Block Diagram and Operation.....	8
2.3 Controller Pin Assignment Details .....	9
2.4 Connector Details .....	10
2.4.1 SmartSense Evaluation Header (Connector J5).....	10
2.4.2 Expansion Connector One (Connector J1) .....	10
2.4.3 Expansion Connector Two (Connector J2) .....	11
2.5 Power the Kit .....	11
2.5.1 Insert Battery.....	11
2.5.2 Default Configuration of Kit .....	12
<b>3. Kit Features</b>	<b>13</b>
3.1 Features of CY8CMBR2044 CapSense Controller.....	13
3.2 SmartSense Feature.....	13
3.2.1 Enable SmartSense Feature.....	13
3.2.2 Test CapSense Buttons with SmartSense Feature Enabled.....	13
3.3 Toggle Feature .....	14
3.3.1 Test CapSense Buttons with Toggle Feature Disabled .....	14
3.3.2 Enable Toggle Feature .....	15
3.3.3 Test CapSense Buttons with Toggle Feature Enabled .....	15
3.4 Flanking Sensor Suppression (FSS) Feature .....	16
3.4.1 Test CapSense Buttons with FSS Feature Disabled.....	16
3.4.2 Enable FSS Feature.....	16
3.4.3 Test CapSense Buttons with FSS Feature Enabled.....	16
3.5 Toggle and FSS Features Combined .....	17
3.5.1 Test CapSense Buttons FSS and Toggle Features Disabled.....	17
3.5.2 Enable Both FSS and Toggle Features.....	17
3.5.3 Test CapSense Buttons with FSS and TOGGLE Feature Enabled.....	18
3.6 Delay Off Feature .....	18
3.6.1 Test CapSense Buttons with Delay Off Feature Disabled.....	18
3.6.2 Enable Delay Off Feature.....	19
3.6.3 Test CapSense Buttons with Delay Off Feature Enabled.....	19
3.7 ScanRate/Sleep Feature .....	20



- 3.7.1 Test CapSense Buttons with Sleep Feature Disabled ..... 20
- 3.7.2 Enable Sleep Feature ..... 20
- 3.7.3 Test CapSense Buttons with Sleep Feature Enabled ..... 21
- 3.8 ARST Feature..... 21
  - 3.8.1 Enable ARST Feature ..... 21
  - 3.8.2 Test CapSense Buttons with ARST Feature Enabled..... 22
- 3.9 FMEA Features ..... 22
  - 3.9.1 Enable FMEA Feature ..... 22
  - 3.9.2 Test FMEA Feature - CapSense Button Short to Ground..... 22
  - 3.9.3 Test FMEA Feature - CapSense Button to Button Short..... 23
- A. Appendix ..... 25**
  - A.1 Board Schematics ..... 25
  - A.2 Board Layouts ..... 27
  - A.3 Bill of Materials ..... 29
  - A.4 Frequently Asked Questions ..... 30

# 1. Introduction



Thank you for your interest in the CY3280-MBR CapSense® Express™ with SmartSense™ Auto-Tuning Kit. The kit is designed to showcase the abilities of configurable capacitive sensing controller CY8CMBR2044. This controller is equipped with SmartSense, which allows engineers to go from prototyping to mass production without re-tuning for manufacturing variations in PCB and/or overlay material properties. For more information, visit <http://www.cypress.com/?id=2014>.

## 1.1 Kit Contents

- CY3280-MBR Kit
- Two AAA batteries
- Overlay - Clear acrylic overlays with matt finish on one side in 1 mm, 2 mm, and 3 mm thickness. 2 mm thick overlay is stuck to the board
- Axial capacitors 10 pF, 22 pF, 33 pF, 68 pF
- Quick Start Guide

## 1.2 Installation

No software installation is required to make the kit work.

## 1.3 Features of CY3280-MBR Kit Board

- Four CapSense buttons of different dimensions
- Four LEDs connected to general purpose output pins
- CapSense based power button and power indicator LED
- Operates from external power supply and battery
- Expansion slots, allowing I/O to expand to external boards

## 1.4 Factory Default Configuration

When shipped, this kit is stuck with the 2 mm overlay; switch SW1 is in Toggle On position and switch SW2 is in Sleep Off position. The LED is expected to turn on when the corresponding button is touched. The kit is configured to provide an approximate battery life of one year in standby mode. If deep sleep mode of CapSense controller is enabled, current consumption can be reduced to 100 nA and the battery life increases accordingly. The deep sleep mode is not enabled in this kit as a host controller is recommended to enable this mode.

**Note** The kit is in standby mode when the CapSense controller based power button and the demonstration buttons and LEDs are in inactive state.

## 1.5 Document Revision History

Table 1-1. Revision History

Revision	PDF Creation Date	Origin of Change	Description of Change
**	11/25/10	BVI	New kit guide.

## 1.6 Documentation Conventions

Table 1-2. Document Conventions for Guides

Convention	Usage
Courier New	Displays file locations, user entered text, and source code: C:\...cd\icc\
<i>Italics</i>	Displays file names and reference documentation: Read about the <i>sourcefile.hex</i> file in the <i>PSoC Designer User Guide</i> .
<b>[Bracketed, Bold]</b>	Displays keyboard commands in procedures: <b>[Enter]</b> or <b>[Ctrl] [C]</b>
File > Open	Represents menu paths: File > Open > New Project
<b>Bold</b>	Displays commands, menu paths, and icon names in procedures: Click the <b>File</b> icon and then click <b>Open</b> .
Times New Roman	Displays an equation: $2 + 2 = 4$
Text in gray boxes	Describes Cautions or unique functionality of the product.

## 2. Kit Operation



CY3280-MBR kit is designed to demonstrate four CapSense buttons and a CapSense based power button. Figure 2-1 illustrates these buttons: demonstration buttons (BTN0 to BTN3) and a CapSense power button (POWER BUTTON). The kit is powered from two AAA on-board batteries, which are placed below the kit in the battery holder. Configurable CapSense controller CY8CMBR2044 supports multiple features. The kit includes required hardware support to successfully demonstrate each feature. See [Kit Features chapter on page 13](#) to know how to demonstrate each feature of the CapSense controller using the kit.

The board has three connectors. Connector J5 can be used to demonstrate the SmartSense feature and connectors J1 and J2 are used to provide external power to the kit and connect output signals for CapSense controller to host systems.

Touch the power button first and ensure the power LED is turned on. Each CapSense button is mapped to an LED (LED 0 to LED3) such that activation of each button can be verified visually by monitoring the LED status. Active status of CapSense buttons are indicated by the ON status of the LEDs.

Figure 2-1. Top and Bottom Views of Kit

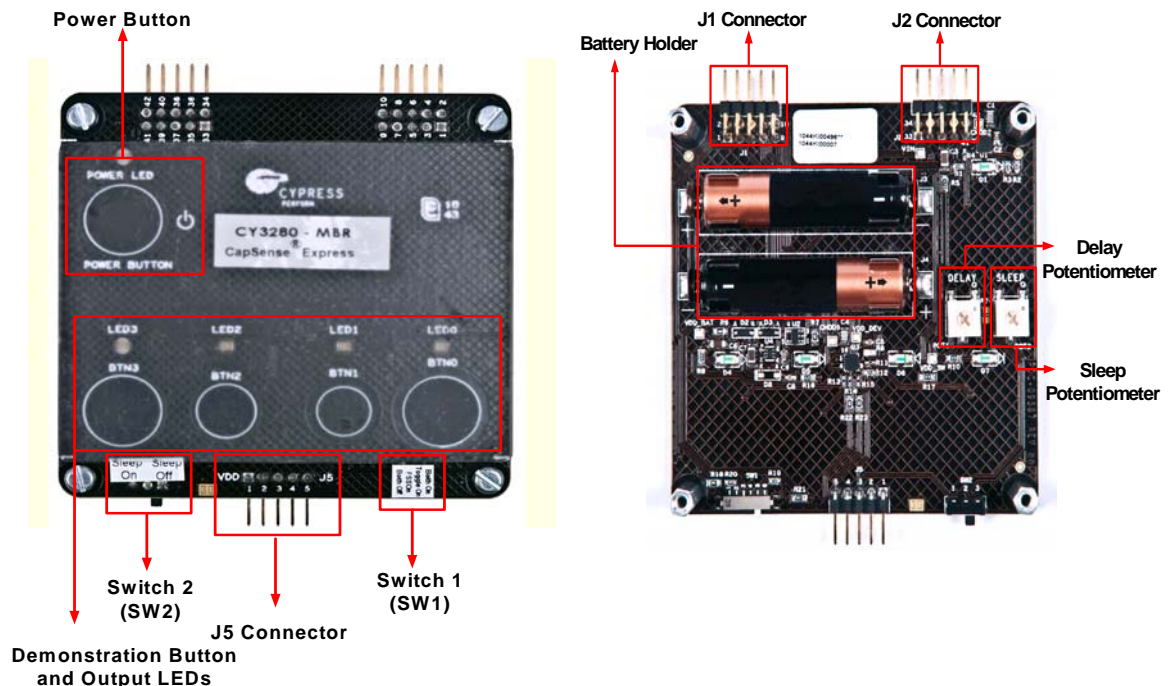

## 2.1 Power Supply

CY3280-MBR kit can be powered from two different power sources: external power supply and on-board battery power. External power supply can be provided from two connectors: J5 and J2.

External power supplied through J2 is gated by the CapSense based power button; however, external power supplied through J5 is not gated.

- On-board battery power supply (place AAA batteries in the battery holder)
- External supply (use pin #41 and pin #39 of Header J2 to connect VDD and GND, respectively)
- External supply (use pin #1 and pin #2 of Header J5 to connect VDD and GND, respectively)

While the external power option supports all operating power supply from 1.71 V to 3.6 V, the on-board battery power supply provides only 3 V operation.

For the kit to work, at least one source of power should be active. The CY8CMBR2044 CapSense controller is powered 200 mV less than what is supplied to the power supply connector J2 due to voltage drop across regulator circuitry. External supply to be used should be greater than 2.0 V and lesser than 3.8 V to provide 1.71 V to 3.6 V supply to the CapSense controller.

## 2.2 System Block Diagram and Operation

Figure 2-2 shows the block diagram of the CY3280-MBR kit. The block diagram has two main sections, power supply and CapSense controller sections. The power supply section is based on the external and on-board battery power. Power on and off control is implemented using a CapSense based power button, which is activated every time the kit is powered. Demo CapSense controller is powered only if the CapSense power buttons is touched to turn on the kit.

Figure 2-2. Block Diagram of CY3280-MBR Kit

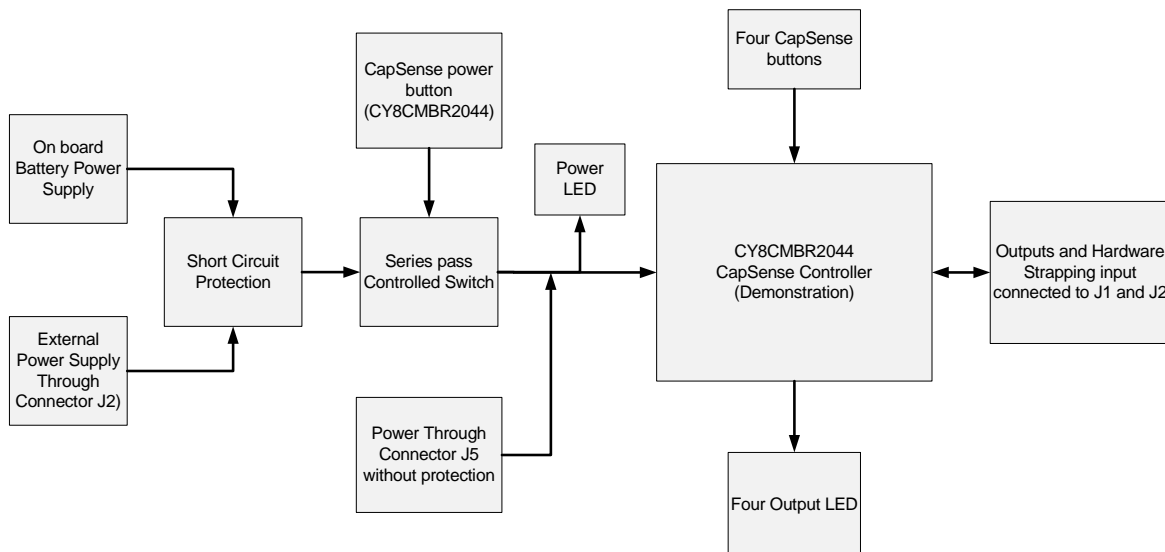



The kit can be powered from three sources. This includes power from on-board battery and external power through the J2 connector. A protection circuit is provided to prevent damage if both these sources are connected at the same time. The protection circuit allows only one power supply to be active at a time. The supply that has higher potential powers the kit. Therefore, to power the kit with less than 3 V external power, the battery should be removed. To power the kit from the battery, external power supply should not be connected or should not be higher than the battery voltage (3 V).

The two power sources mentioned above are connected to a series pass switch, which is controlled by the CapSense based power button. An LED is used to indicate the power ON condition of the kit. The third power source option is through the J5 connector; this power supply does not have protection circuit. It is recommended not to power the kit from any other source when the external power through J5 is connected.

Four CapSense buttons and receptive LEDs are connected to the CapSense controller used for demonstration. The output signals and hardware strapping inputs are also connected to J1 and J2 connectors. This helps to connect them to host and monitor status and control the CapSense controller.

## 2.3 Controller Pin Assignment Details

The following table shows the pin assignment of the CapSense controller. To learn how to assign pins for your design and recommendations on pin selection, refer the [CY8CMBR2044 data sheet](#).

Pin	Label	Description	Unused
1	GPO1	GPO activated by CS1	Leave open
2	GPO0	GPO activated by CS0	Leave open
3	Toggle/FSS	Controls FSS and toggle features	Ground
4	Delay	Controls delay off time	Ground
5	CS0	CapSense input 0	Ground
6	CS1	CapSense input 1	Ground
7	V <sub>SS</sub>	Ground	
8	CS2	CapSense input 2	Ground
9	ARST	Controls auto reset delay	Leave open
10	CS3	CapSense input 3	Ground
11	XRES	Device reset, active high, with internal pull down	Leave open
12	ScanRate/Sleep	Controls scan rate and deep sleep	Ground
13	V <sub>DD</sub>	Power	
14	GPO3	GPO activated by CS3	Leave open
15	CMOD	External integrating capacitor, connect a 2.2 nF ( $\pm 5\%$ ) between this pin and ground	
16	GPO2	GPO activated by CS2	Leave open

## 2.4 Connector Details

### 2.4.1 SmartSense Evaluation Header (Connector J5)

Various signals are connected to the J5 connector, as shown in the following table. For more information on each signal, see the schematics of the CY3280-MBR kit.

VDD and GND are connected to pin #1 and pin #2 on this connector such that external power supply can be connected to kit, if required. This power supply is not gated through CapSense based power buttons; therefore, the same voltage applied on the connector reaches the CapSense controller. When the kit is powered through J5 connector, only CapSense controller is powered, LEDs and other part of kit do not function.

It is not recommended to power the kit through J5 connector and one of the gated power sources.

Pin #3 of the J5 connector is connected to reset pin (XRES) of the CapSense controller; providing logic high signal to this pin resets the CapSense controller.

The remaining two pins (pin #4 and pin #5) are connected to CapSense sensors BTN1 and BTN2, respectively. This is done to provide an option to increase the capacitance of the sensor and evaluate the SmartSense based auto tuning feature of CY8CMBR2044.

Connector J5 (SmartSense Evaluation Header)

J5 - 1	VDD (external only to CapSense controller)
J5 - 2	GND
J5 - 3	XRES
J5 - 4	CS1 (BTN1)
J5 - 5	CS2 (BTN2)

### 2.4.2 Expansion Connector One (Connector J1)

All the GPO signals are connected to J1 connector, allowing the output signals of CapSense to be interfaced with host controllers. This is a good option to build a mock design for testing purposes.

All hardware strapping inputs of CY8CMBR2044, except ARST, are connected to connector J1. These signals can be used to measure the value of the strapping input resistor configured.

One end of the ScanRate/Sleep resistor is connected to pin #1 of J1. When the sleep mode is in enabled state by making SW2 in Sleep On, the CapSense controller can be made to work in deep sleep mode by providing recommended logic signal on the pin 1 of J1 connector. Refer the [CY8CMBR2044 data sheet](#) for details on how to activate deep sleep mode and reduce the current consumption of CapSense controller to 100 nA.

Connector J1 (Expansion Connector -1)

J1 - 1	SLEEP_CNT (control input of ScanRate/Sleep)
J1 - 2	XRES
J1 - 3	DELAY
J1 - 4	TOGGLE/FSS
J1 - 5	GND
J1 - 6	GND
J1 - 7	GPO 0
J1 - 8	GPO 1
J1 - 9	GPO 2
J1 - 10	GPO 3

### 2.4.3 Expansion Connector Two (Connector J2)

Using the VDD and GND signals available in J2 connector, the kit can be powered from external power supply. Note that this power supply is gated through CapSense based power button circuitry. CapSense controller receives 200 mV less than what is applied to connector due to the drop out across the power button switch circuitry. External supply should be greater than 2.0 V and less than 3.8 V to provide 1.71 V to 3.6 V supply to the CapSense Controller.

Connector J2 (Expansion Connector -2)

J2-33	ARST
J2-34	Not Connected
J2-35	GND
J2-36	GND
J2-37	Not Connected
J2-38	Not Connected
J2-39	GND
J2-40	GND
J2-41	VDD (External - Gated by the power button
J2-42	Not Connected

## 2.5 Power the Kit

The following steps provide detailed instructions to power the kit. Note that these instructions are available in brief in the quick start guide.

### 2.5.1 Insert Battery

Two AAA size batteries are provided with the kit. Insert these batteries in the battery holder provided on the bottom side of the kit. Ensure polarity of the battery, as shown in the following figure.

Figure 2-3. Insert Battery in Batter Holder

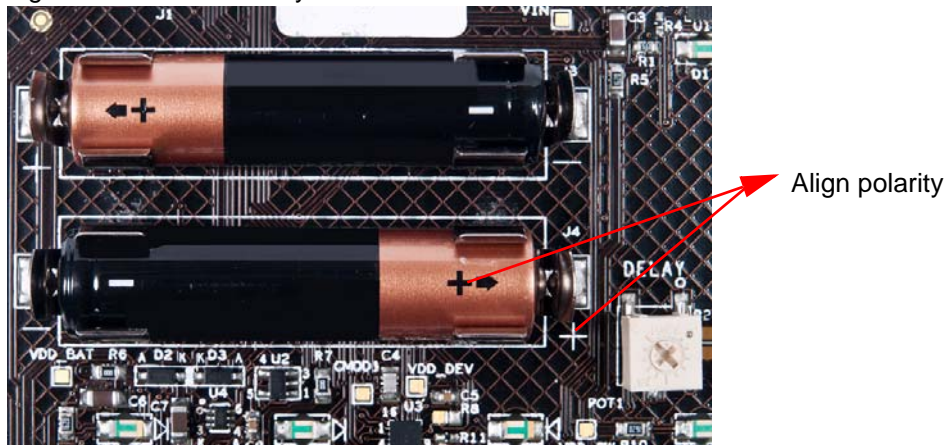

## 2.5.2 Default Configuration of Kit

Ensure SW1 is in Both Off position and SW2 is in Sleep Off position. Turn the 'Delay' and 'Sleep' potentiometers to extreme right to disable 'Delay Off' and sleep features of CapSense controller.

Figure 2-4. Default Configuration

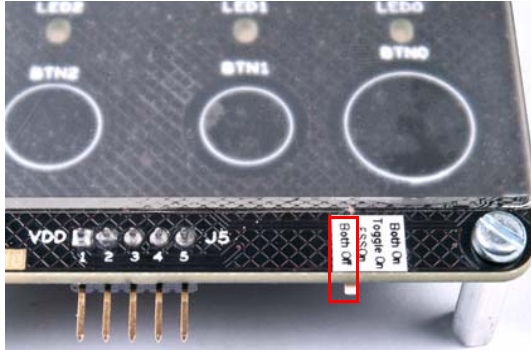

1. SW1 in Both Off position

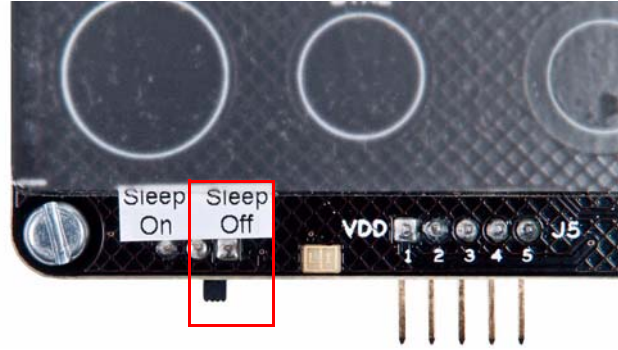

2. SW2 in Sleep Off position

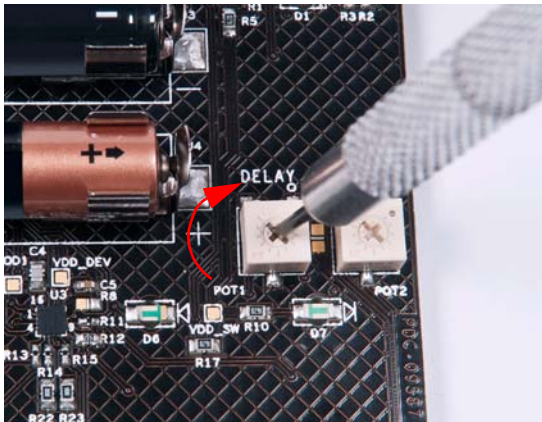

3. Turn 'DELAY' potentiometer to extreme right

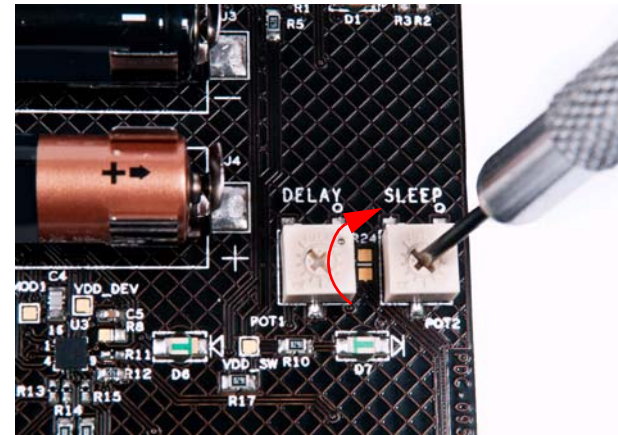

4. Turn 'SLEEP' potentiometer to extreme right

# 3. Kit Features



This section demonstrates the main features of CY8CMBR2044 CapSense controller using the CY3280-MBR kit.

## 3.1 Features of CY8CMBR2044 CapSense Controller

CY8CMBR2044 has the following features:

- SmartSense
- Toggle
- Flanking sensor suppression (FSS)
- Delay off
- ScanRate/Sleep
- ARST

Refer the [CY8CMBR2044 data sheet](#) for more details on these features.

**Note** All features of the CY3280-MBR2044 CapSense controller can be enabled together. For ease of demonstration, each feature is enabled separately in this document.

## 3.2 SmartSense Feature

The following steps help to demonstrate the SmartSense feature of CY8CMBR2044 CapSense controller using CY3280-MBR kit. Before proceeding, power the kit in default mode using the procedure provided in the section [2.5 Power the Kit on page 11](#).

### 3.2.1 Enable SmartSense Feature

CY8CMBR2044 CapSense controller is built around robust CSD capacitive sensing method and patented SmartSense auto tuning algorithm. There is no action required to enable SmartSense feature in CY8CMBR2044 CapSense controller. It is automatically enabled on power up.

### 3.2.2 Test CapSense Buttons with SmartSense Feature Enabled

Touch any CapSense button; the respective LED turns on. When the finger is released, the respective LED turns off.

Connect the 10-pF capacitor provided with the kit to the J5 connector, the mark on the capacitor connector facing up. This increases the parasitic capacitance of the CS2 sensor input, which is connected to BTN2 sensor.

Press the power button to turn off the kit; press again to turn on power. Automatic self tuning is performed only on power up and not on run time.

Touch BTN2, there is no difference in the way it works. Note that although the parasitic capacitance of the sensor is increased, the sensor continues to work with automated tuning.



Figure 3-1. External Capacitor Connected to J5

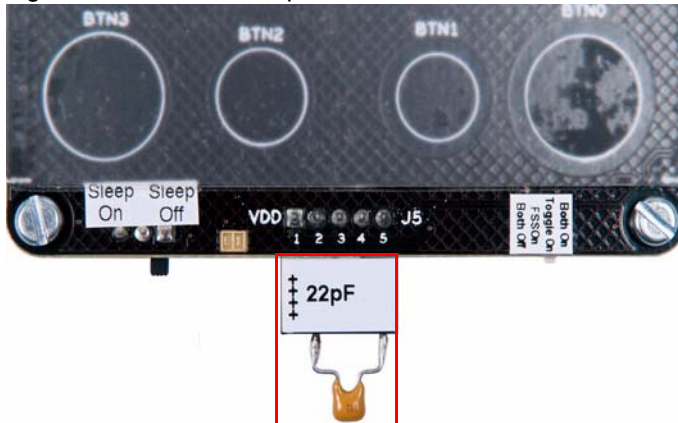

Connect capacitors of different values (22 pF and 33 pF). Ensure that power is toggled after placing a new capacitor. Button BTN2 continues to work. Now connect the 68-pF capacitor; BTN2 stops working. If the sensor is touched, no LED turns on. This is because of SmartSense, which works up to 41 pF.

### 3.3 Toggle Feature

The following steps help to demonstrate the Toggle feature of CY8CMBR2044 CapSense controller using CY3280-MBR kit. Before proceeding, power the kit in default mode using the procedure provided in the section [2.5 Power the Kit on page 11](#).

#### 3.3.1 Test CapSense Buttons with Toggle Feature Disabled

Touch a CapSense button; the respective LED turns on. When you release the finger, the LED turns off. This is normal operation of the CapSense controller seen on all CapSense buttons.

Figure 3-2. Kit with Toggle Feature Disabled



1. Touch a button; LED turns on

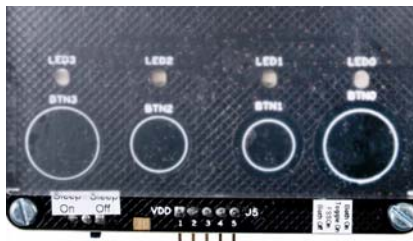

2. Release the button; LED turns off

### 3.3.2 Enable Toggle Feature

Ensure the position of SW1 is changed to Toggle On to enable the Toggle feature, see [Figure 3-3](#). Touch the power button once to turn off the power; the power LED is turned off. Again press the power button to turn on the power. This is because, the CapSense controller should be reset every time the hardware strapping inputs change. The toggle feature is now enabled.

Figure 3-3. Switch Position for Toggle Feature



### 3.3.3 Test CapSense Buttons with Toggle Feature Enabled

Touch any CapSense button; the respective LED turns on. When the finger is released from the button, the LED remains in the ON state. If the same button is pressed again, the LED turns off and remains in same state when finger is released. At the next touch, the LED turns on and remains in same state when finger is released. This means, every time the button is pressed, the state of the button sensor output keeps toggling between the ON and OFF states. This behavior is seen on all CapSense buttons.

Figure 3-4. Toggle Feature Test Sequence

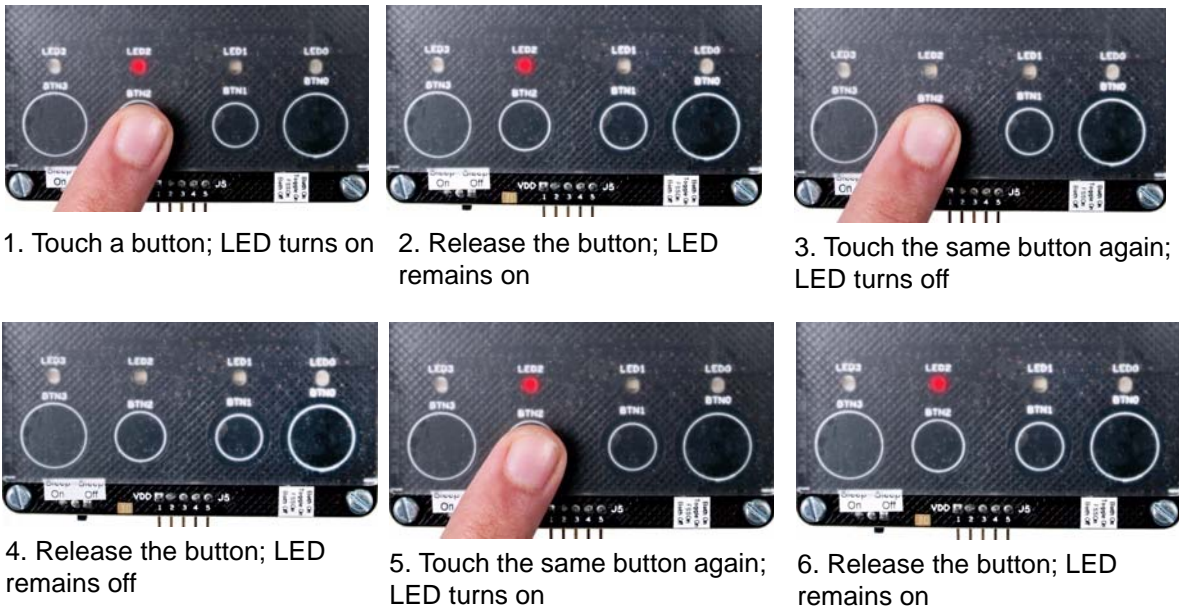

### 3.4 Flanking Sensor Suppression (FSS) Feature

The following steps demonstrate the FSS feature of CY8CMBR2044 CapSense controller using CY3280-MBR kit. Before proceeding, power the kit in default mode using the procedure provided in the section [2.5 Power the Kit on page 11](#).

#### 3.4.1 Test CapSense Buttons with FSS Feature Disabled

Touch more than one CapSense buttons simultaneously; the respective LEDs turn on. When each button is released, respective LEDs turn OFF. This is normal operation of the CapSense controller, seen on all CapSense buttons.

Figure 3-5. Kit with FSS Feature Disabled



#### 3.4.2 Enable FSS Feature

Ensure the SW1 switch is in FSS On to enable the FSS feature, see [Figure 3-6](#). Touch the power button once to turn off the power and ensure the power LED is turned off. Press the power button again to turn on the power. This is because, the CapSense controller should be reset every time the hardware strapping inputs change. The FSS feature is now enabled.

Figure 3-6. Switch Position for FSS Feature

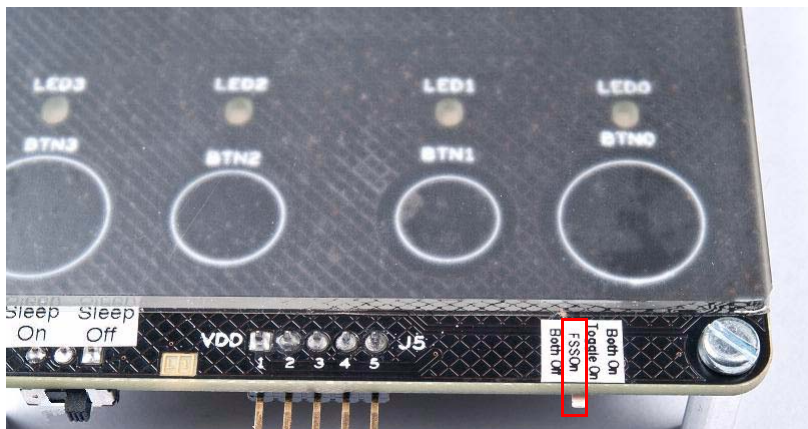

#### 3.4.3 Test CapSense Buttons with FSS Feature Enabled

Touch more than one CapSense button; only one button is turned on. Try with other buttons and notice the same behavior. This feature help to distinguish closely spaced sensors and protect them from false triggers. Refer the [CY8CMBR2044 data sheet](#) for more information.



Figure 3-7. FSS Feature Test Sequence



### 3.5 Toggle and FSS Features Combined

The following steps demonstrate the FSS and Toggle features of CY8CMBR2044 CapSense controller enabled together. Before proceeding, power the kit in default mode using the procedure provided in the section [2.5 Power the Kit on page 11](#).

#### 3.5.1 Test CapSense Buttons FSS and Toggle Features Disabled

Touch more than one CapSense buttons; the respective LEDs turn on. When each button is released, the respective LED turns off. You have seen this behavior in previous sections.

Figure 3-8. Kit with Toggle and FSS Features Disabled

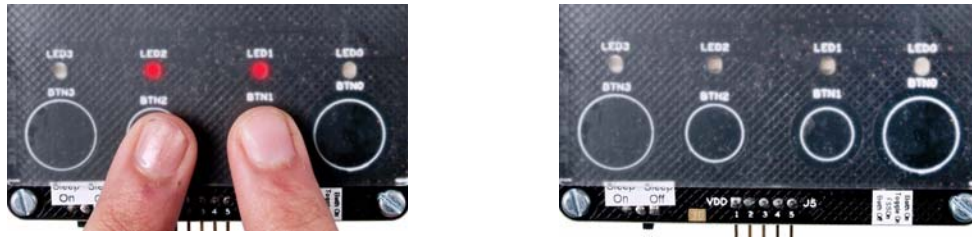

#### 3.5.2 Enable Both FSS and Toggle Features

Ensure the SW1 switch is changed to Both On to enable FSS and Toggle features together, see [Figure 3-9](#). Touch the power button once to turn off the power; ensure the power LED is turned off. Press the power button again to turn on the power. This is because, the CapSense controller should be reset every time the hardware strapping inputs change. The FSS and Toggle features are now enabled.

Figure 3-9. Switch Position for Toggle and FSS Features

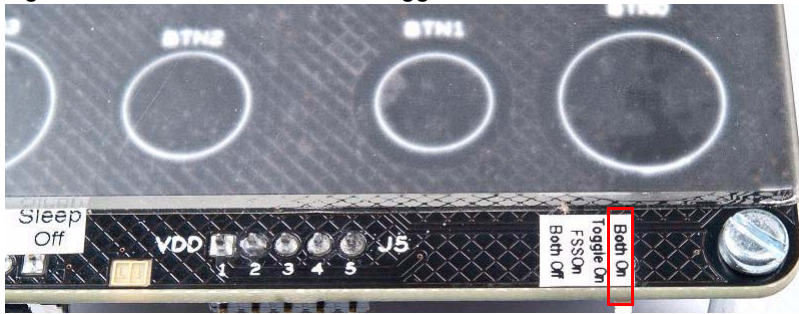

### 3.5.3 Test CapSense Buttons with FSS and TOGGLE Feature Enabled

Touch more than one CapSense button; only one LED is turned on. When the same button is released, the LED remains in ON state. Successive activation of button sensor makes the respective output toggle between the ON and OFF states. At the same time, CapSense controller stops activation of more than one button together.

Figure 3-10. Test Sequence

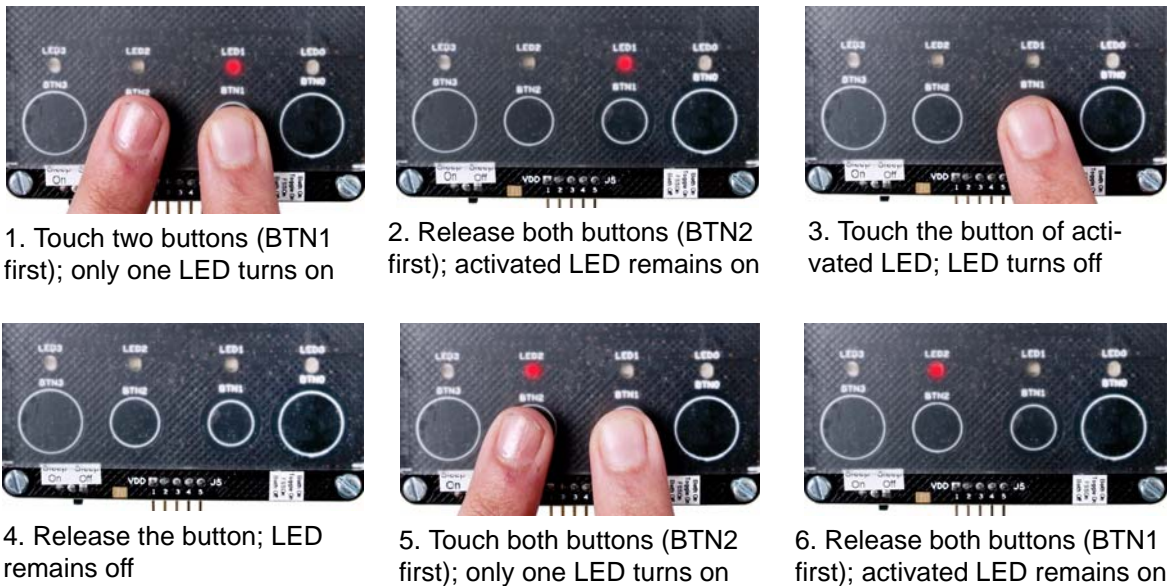

1. Touch two buttons (BTN1 first); only one LED turns on

2. Release both buttons (BTN2 first); activated LED remains on

3. Touch the button of activated LED; LED turns off

4. Release the button; LED remains off

5. Touch both buttons (BTN2 first); only one LED turns on

6. Release both buttons (BTN1 first); activated LED remains on

## 3.6 Delay Off Feature

The following steps demonstrate the Delay Off feature of CY8CMBR2044 CapSense controller using CY3280-MBR kit. Before proceeding, power the kit in default mode using the procedure provided in the section [2.5 Power the Kit on page 11](#).

### 3.6.1 Test CapSense Buttons with Delay Off Feature Disabled

Touch a CapSense button; the respective LED turns on. When the finger is released, the LED turns off immediately. This is normal operation of the CapSense controller, seen on all CapSense buttons.

Figure 3-11. Kit with Delay Off Feature Disabled



1. Touch a button: LED turns on

2. Release button; LED turns off immediately

### 3.6.2 Enable Delay Off Feature

The Delay Off pin is connected to a potentiometer and helps to change the resistor value to all supported values. This potentiometer is marked as DELAY on the kit. The kit should be held such that 'DELAY' text is readable. Turn the potentiometer to the extreme left.

Touch the power button once to turn off the power and ensure the power LED is turned off. Press the power button again to turn on the power. This is because, the CapSense controller should be reset every time the hardware strapping inputs change. The Delay Off feature is now enabled.

Figure 3-12. Delay Potentiometer Turned Extreme Left

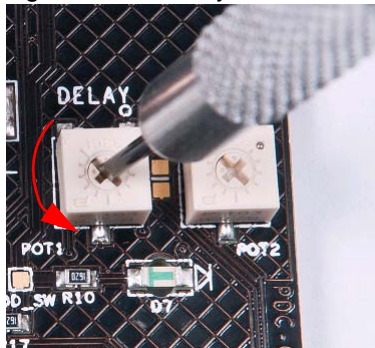

### 3.6.3 Test CapSense Buttons with Delay Off Feature Enabled

Touch any CapSense button; the respective LED turns on. When the finger is released, the LED turns off after some delay. Play with it; the delay depends on the value of the resistor connected to the Delay Off input. Keep the potentiometer at different positions to see different delays. Ensure power is toggled every time the position of the potentiometer is changed. Refer the [CY8CMBR2044 data sheet](#) for more information on this feature.

Figure 3-13. Test Sequence for Delay Off Feature



1. Touch a button; LED turns on

2. Release the button; LED remains on

3. LED turns off automatically without any action after 2 seconds



The time delay at which the LED is turned off automatically after the release of the respective button can be controlled using the potentiometer. Note that turning the potentiometer halfway make the LED turn off automatically within half the time of the first experiment. Refer the [CY8CMBR2044 data sheet](#) for more details.

### 3.7 ScanRate/Sleep Feature

The following steps demonstrate the Sleep feature of CY8CMBR2044 CapSense controller using CY3280-MBR kit. Before proceeding, power the kit in default mode using the procedure provided in the section [2.5 Power the Kit on page 11](#).

#### 3.7.1 Test CapSense Buttons with Sleep Feature Disabled

Touch a CapSense button; the respective LED turns on. When the finger is released, the LED turns off immediately. This is normal operation of the CapSense controller, seen on all CapSense buttons.

Figure 3-14. Kit with Sleep Feature Disabled

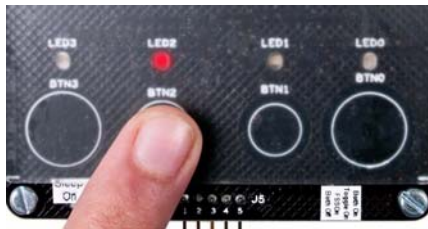

1. Touch a button; LED turns on



2. Release the button; LED turns off

#### 3.7.2 Enable Sleep Feature

ScanRate/Sleep pin of the CapSense controller is connected to a potentiometer. This helps to change the value of hardware strapping input connected to the pin. This potentiometer is marked as SLEEP on the kit. The kit should be held such that 'SLEEP' text is readable. Ensure the SW2 switch is configured in Sleep On. Turn the Sleep potentiometer to the left, but not extreme left.

Touch the power button once to turn off the power and ensure the LED is turned off. Press the power button again to turn on the power. This is because, the CapSense controller should be reset every time the hardware strapping inputs change. The Sleep feature is now enabled.

Figure 3-15. Sleep Potentiometer Turned to Left

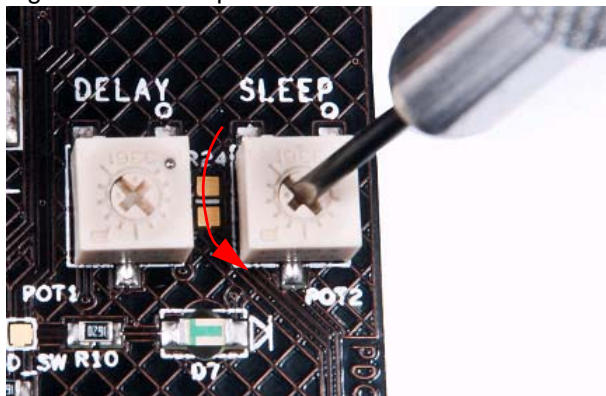

### 3.7.3 Test CapSense Buttons with Sleep Feature Enabled

Touch any CapSense button; the respective LED turns on. When the finger is released, the LED turns off. There is no visible difference, but the CY8CMBR2044 CapSense controller is now working at lower average power. To test the average current consumed by the CapSense controller, desolder the R7 resistor and connect an ammeter in its place. Removing the R7 resistor allows to measure the current consumed by the CapSense controller without including the current consumed by other circuits such as LEDs. The ammeter shows the average power consumed by the CapSense controller. As the potentiometer is turned more towards the left, the average power continues to reduce.

Figure 3-16. Setup to Measure Average Current

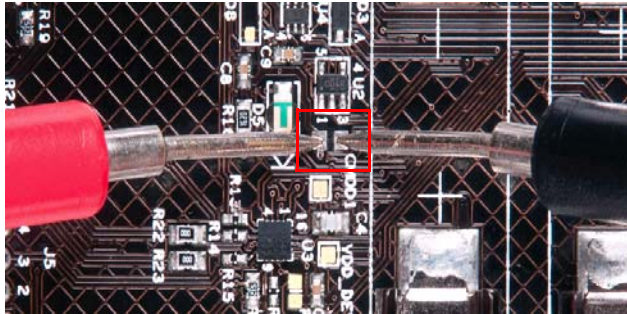

## 3.8 ARST Feature

The following steps demonstrate the auto reset (ARST) feature of CY8CMBR2044 CapSense controller using CY3280-MBR kit. Before proceeding, power the kit in default mode using the procedure provided in the section [2.5 Power the Kit on page 11](#).

### 3.8.1 Enable ARST Feature

The ARST feature is enabled in this kit by default. The 5.1-K resistor connected to ARST port pin and ground configures the sensor auto reset time to 20 seconds. No change is needed in the kit to enable the ARST feature.

Figure 3-17. Resistor Connected to ARST

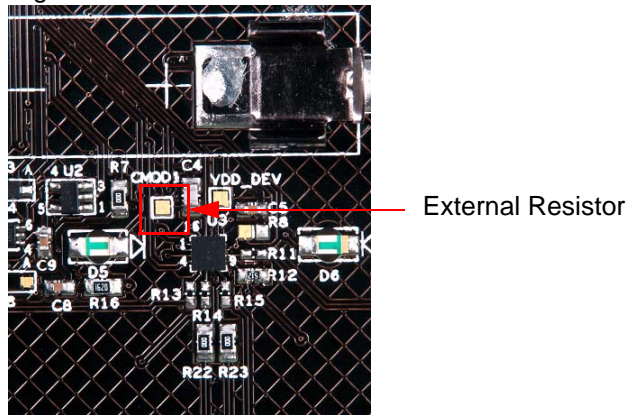

### 3.8.2 Test CapSense Buttons with ARST Feature Enabled

Touch any CapSense button; the respective LED turns on. Do not release the button; keep the finger pressed for more than 20 seconds. Notice that the LED turns off automatically after 20 seconds. Release the buttons and touch the same buttons again, it works as usual.

Figure 3-18. Test Sequence for ARST Feature



1. Touch a button; LED turns on
2. Hold button in same state
3. After 20 seconds, LED turns off automatically

ARST signal is connected to pin #33 of J2 connector. This helps to connect the ARST pin to ground and make the sensor auto reset time as 5 seconds. When ARST pin is grounded, auto reset time is reduced to 5 second. Refer the [CY8CMBR2044 data sheet](#) for more information on this feature.

## 3.9 FMEA Features

The following steps demonstrate the Failure Mode Effective Analysis (FMEA) feature of CY8CMBR2044 CapSense controller using CY3280-MBR kit. Before proceeding, power the kit in default mode using the procedure provided in [2.5 Power the Kit on page 11](#).

### 3.9.1 Enable FMEA Feature

The FMEA feature is enabled in CY8CMBR2044 CapSense controller by default. No change is needed in the kit.

### 3.9.2 Test FMEA Feature - CapSense Button Short to Ground

Follow these steps:

1. Press the power button to turn off the kit.
2. Connect a wire between pin# 2 and pin# 4 of connector J5. This shorts the BTN1 sensor to ground.
3. Press the power button to turn on the kit.

FMEA routine is executed by the CapSense controller on power up and the sensor shorted to ground is detected. On power up, observe a pulse of 5 ms width on LED1 pin, which indicates that BTN1 is shorted to ground. CapSense controller disables the button sensors that are shorted to ground. Touch **BTN1** and see that LED1 is not turned on. Other buttons work normally.

Figure 3-19. BTN1 Sensor Shorted to Ground

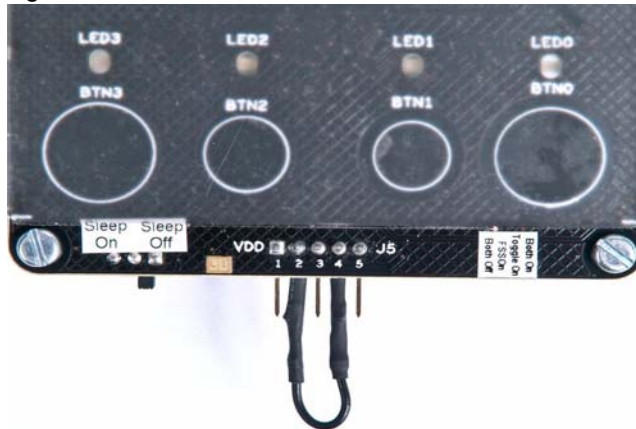

### 3.9.3 Test FMEA Feature - CapSense Button to Button Short

Follow these steps:

1. Press the power button to turn off the kit.
2. Connect a wire between pin# 4 and pin# 5 of connector J5. This shorts BTN1 and BTN2 sensors.
3. Press the power button to turn on the kit.

FMEA routine is executed by the CapSense controller on power up and the sensor to sensor short is detected. On power up, observe a pulse of 5 ms width on LED1 and LED2 pins, which indicates that BTN1 is shorted to BTN2. CapSense controller disables the button sensors that are shorted to each other. Touch **BTN1** or **BTN2**; note that the respective LEDs are not turned on. Other buttons work normally.

Figure 3-20. BTN1 Sensor Shorted to Ground







# A. Appendix



## A.1 Board Schematics

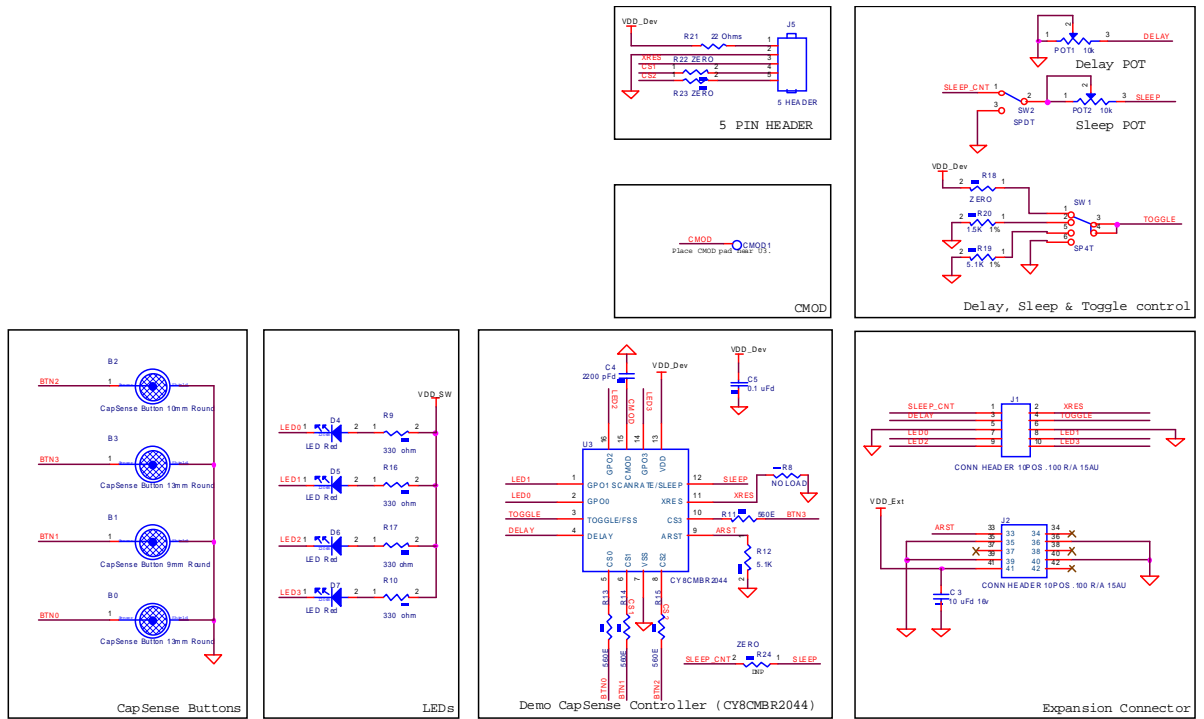

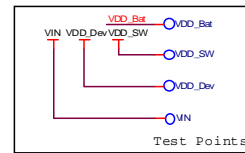
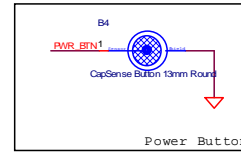
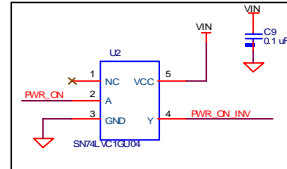
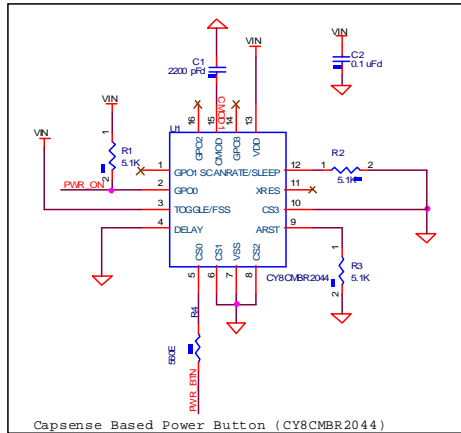
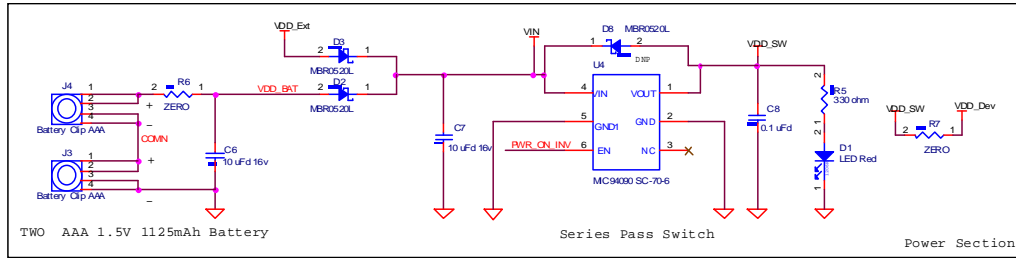

## A.2 Board Layouts

### A.2.1 PDC-09587 Top

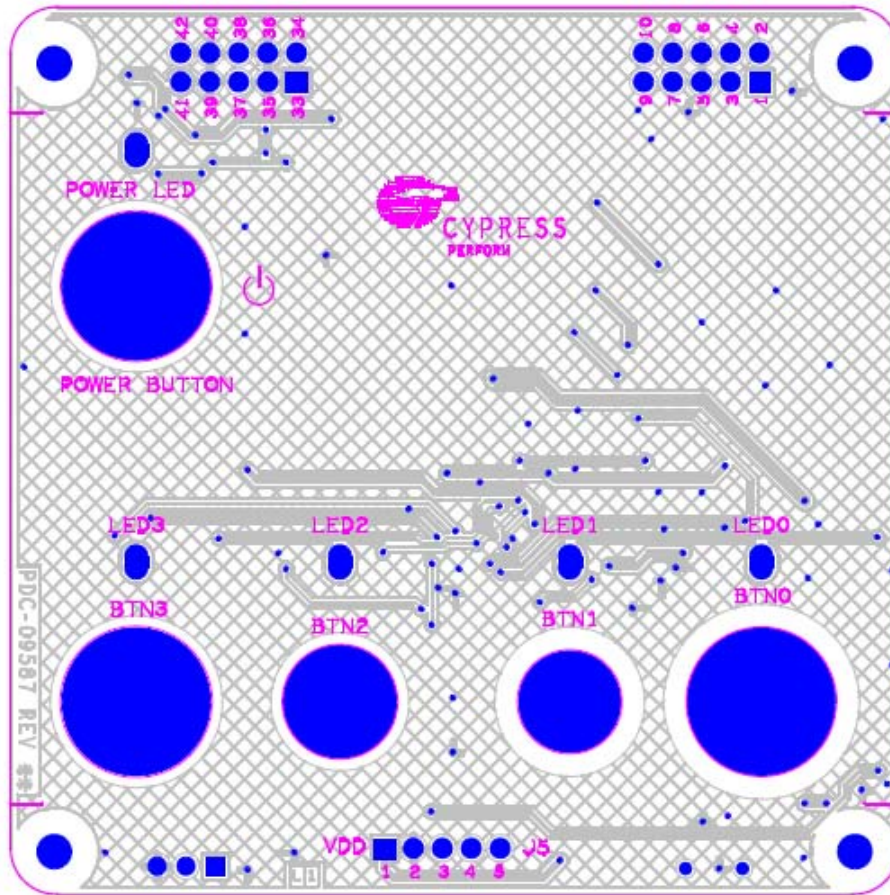

A.2.2 PDC-09587 Bottom

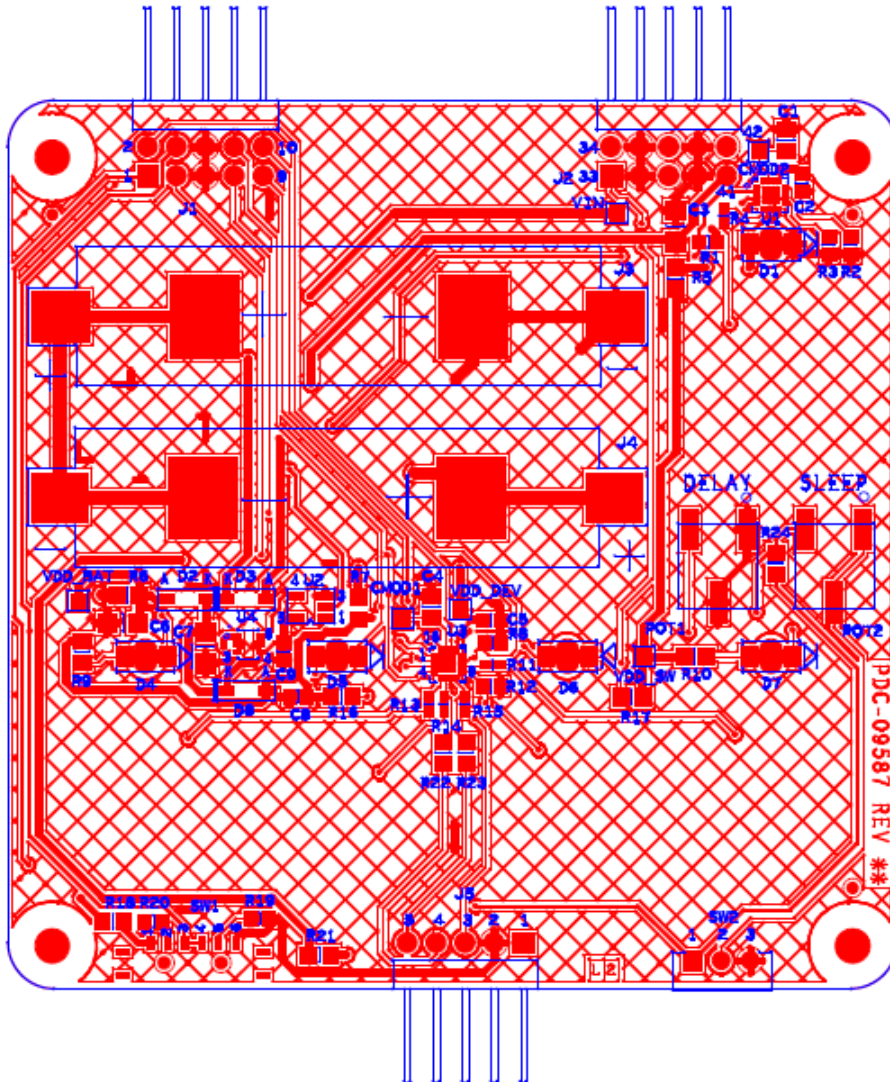

### A.3 Bill of Materials

Item	Qty	Reference	Value	Description	Manufacturer	Mfr Part Number
1				PCB	Cypress	PDC-09587 Rev04
2	2	C1,C4	2200 pFd	CAP CER 2200PF 50V 5% C0G 0805	Murata Electronics	GRM2165C1H222 JA01D
3	4	C2,C5,C8,C9	0.1 uFd	CAP .10UF 10V CERAMIC X7R 0603	Kemet	C0603C104K8RA CTU
4	3	C3,C6,C7	10 uFd 16v	CAP CERAMIC 10.0UF 16V X5R 1206	Kemet	C1206C106K4PA CTU
5	5	D1,D4,D5,D6,D7	LED Red	LED Red CLEAR 1206 REAR MNT SMD	Stanley Electric Co	BR1111R-TR
6	2	D2,D3	DIODE SCHOTTKY	DIODE SCHOTTKY 0.5A 20V SOD-123	Fairchild Semiconductor	MBR0520L
7	2	J1,J2	CONN HEADER 10POS .100 R/A 15AU	CONN HEADER 10POS .100 R/A 15AU	FCI	68021-210HLF
8	4	J3,J4	Battery Clip AAA	CLIP BATTERY AAA/N .375X.460" SS	Keystone Electronics	55TR
9	1	J5	5 HEADER	CONN MALE 5POS .100" R/A GOLD	3M	961105-5604-AR
10	2	POT1,POT2	10k	TRIMPOT 10K OHM 6MM SQ SMD	Bourns Inc.	3361P-1-103GLF
11	5	R1,R2,R3,R12,R19	5.1K	RES 5.1K OHM 1/16W 1% 0603 SMD	Yageo Corporation	RC0603FR-075K1L
12	1	R20	1.5K	RES 1.50K OHM 1/16W 1% 0603 SMD	Yageo Corporation	RC0603FR-071K5L
14	5	R4,R11,R13,R14,R15	560E	RES 560 OHM 1/16W 5% 0402 SMD	Yageo Corporation	RC0402JR-07560RL
15	5	R5,R9,R10,R16,R17	330 ohm	RES 330 OHM 1/8W 1% 0805 SMD	Panasonic-ECG	ERJ-6ENF3300V
16	5	R6,R7,R18,R22,R23	ZERO	RES 0.0 OHM 1/10W 5% 0805 SMD	Panasonic-ECG	ERJ-6GEY0R00V
17	1	SW1	SP4T	SWITCH SLIDE SP4T LOW PROF SMD	Copal Electronics Inc	CUS-14TB
18	1	SW2	SPDT	SWITCH SLIDE SPDT .3A RT ANGLE	E-Switches	EG1270
19	2	U1,U3	CY8CMBR2044	CY8CMBR2044	Cypress	CY8CMBR2044
20	1	U4	MIC94090 SC-70-6	IC LOAD SW HGH SIDE 1.2A SC70-6	Micrel Inc	MIC94090YC6 TR
21	1	U2	SN74LVC1GU04	IC SINGLE INVERTER GATE SOT-23-5	Texas Instruments	SN74LVC1GU04D BVR
22	1	R21	ERJ-6GEYJ220V	RES 22 OHM 1/8W 5% 0805 SMD	Panasonic-ECG	ERJ-6GEYJ220V
<b>No Load Components</b>						
23	1	B0	CapSense Button 13mm Round			
24	1	B1	CapSense Button 9mm Round			
25	1	B2	CapSense Button 10mm Round			
26	2	B3,B4	CapSense Button 13mm Round			
27	6	CMOD1,CMOD2,VIN, VDD_Dev,VDD_Bat,V DD	T POINT R			
28	1	R24	ZERO	RES 0.0 OHM 1/10W 5% 0805 SMD	Panasonic-ECG	ERJ-6GEY0R00V
29	1	R8	NO LOAD			
30	1	D8	DIODE SCHOTTKY	DIODE SCHOTTKY 0.5A 20V SOD-123	Fairchild Semiconductor	MBR0520L

## A.4 Frequently Asked Questions

This section provides solutions for errors that you may encounter when working with the CY3280-MBR kit.

### **Q. Power LED does not turn when power button is pressed**

A. This can be due to the following reasons:

- The kit is not powered from any of the power sources. Ensure that there is a power supply.
- The battery connected to the kit does not have charge. In this case, replace the old batteries with a new AAA battery set or try powering the kit from external power source.
- Battery inserted in reverse. Note that the polarity of the battery should match the polarity mark given on the kit. Follow the steps in section [2.5 Power the Kit on page 11](#) to insert the batteries correctly into the battery holder.

### **Q. BTN1 and BTN2 does not work with 5 mm overlays**

A. For a button sensor to work with overlay of specific thickness, the button should have the required diameter. The diameter of BTN1 and BTN2 is not enough to support the 5 mm overlay. This also means that to support particular overlay thinness, correct value of button diameter should be selected in your design. To find the required button diameter for particular overlay thinness, refer the [CY8CMBR2044 data sheet](#), the application note, [AN59004 - Four Button CapSense Design using CY8CMBR2044](#), and the [Design Guide Tool](#).

### **Q. Some buttons are too sensitive with 2 mm overlay**

A. For a button to successfully work at correct sensitivity with given overlay, it is recommended to choose the button size according to the design box. If design box recommendation is not followed, buttons of bigger size may be oversensitive with thinner overlays.

### **Q. Touching on the bottom layer of PCB creates false trigger of buttons**

A. Traces connecting CapSense sensor and CapSense controller are routed on the bottom layer of the PCB. When those trace are touched, the sensors can create a false trigger. This is because, the traces are touched without any overlay, making the trace very sensitive. However, in the actual product, PCB and traces will not be accessible for the user and hence this is not a problem.

### **Q. When external capacitors are added to J5 to increase the parasitic capacitance of BTN2, sensors produces false trigger**

A. The BTN1 and BTN2 sensor are connected to J5 connector. When connecting the capacitor to the sensor, sensor capacitance is increased. This is similar to the capacitance increase due to the finger touch. Therefore, the CapSense controller misinterprets it as finger touch. When external capacitors are connected, the power should be toggled to offset the capacitance increase.

### **Q. After changing the switch positions, no change is observed in kit operation**

A. Hardware strapping inputs are read by the CapSense controller only during the boot up. Whenever a hardware strapping input status is changed, CapSense controller should be rest using XRES pin or power should be toggled for the change to take effect.

**Q. Additional overlay sometimes create false triggers**

A. When an overlay is placed on the top of the button, capacitance may be increased and this is interpreted as finger signal. Every time overlay is changed, CapSense controller should be reset using XRES or power should be toggled.

**Q. Touching the J5 connector creates false triggers on BTN1 and BTN2**

A. BTN1 and BTN2 are connected to pin #4 and pin #5 of the J5 connector for evaluation of SmartSense. Touching the J5 connector increases the capacitance of BTN1 and BTN2, misinterpreted as a button touch. In the actual product, sensor signals are not exposed.





Компания «Life Electronics» занимается поставками электронных компонентов импортного и отечественного производства от производителей и со складов крупных дистрибьюторов Европы, Америки и Азии.

С конца 2013 года компания активно расширяет линейку поставок компонентов по направлению коаксиальный кабель, кварцевые генераторы и конденсаторы (керамические, пленочные, электролитические), за счёт заключения дистрибьюторских договоров

Мы предлагаем:

- Конкурентоспособные цены и скидки постоянным клиентам.
- Специальные условия для постоянных клиентов.
- Подбор аналогов.
- Поставку компонентов в любых объемах, удовлетворяющих вашим потребностям.
- Приемлемые сроки поставки, возможна ускоренная поставка.
- Доставку товара в любую точку России и стран СНГ.
- Комплексную поставку.
- Работу по проектам и поставку образцов.
- Формирование склада под заказчика.
- Сертификаты соответствия на поставляемую продукцию (по желанию клиента).
- Тестирование поставляемой продукции.
- Поставку компонентов, требующих военную и космическую приемку.
- Входной контроль качества.
- Наличие сертификата ISO.

В составе нашей компании организован Конструкторский отдел, призванный помогать разработчикам, и инженерам.

Конструкторский отдел помогает осуществить:

- Регистрацию проекта у производителя компонентов.
- Техническую поддержку проекта.
- Защиту от снятия компонента с производства.
- Оценку стоимости проекта по компонентам.
- Изготовление тестовой платы монтаж и пусконаладочные работы.



Тел: +7 (812) 336 43 04 (многоканальный)

Email: [org@lifeelectronics.ru](mailto:org@lifeelectronics.ru)