

# Weller Soldering Tips

## Innovative Application Solutions



**Weller**<sup>®</sup>

A comprehensive tip guide

# Original tips guarantee top quality and reduced costs.



## Why Genuine Weller?

### Perfect Solder Joints

**Only genuine Weller tips** are precisely matched with the homogeneous Weller heating system, which offers the production of only the highest quality solder joints.

### High-Cost Efficiency

**Heat Delivery**  
Rapid and stable heat delivery provides a repeatable solder process with a productivity increase of up to 50%.

### Original Top Quality

**Only the Best Materials**  
Silver is used as a superior heat conductor in the heating element, optimizing heat transfer.

**Manufacturer Warranty**  
The Weller warranty can **ONLY** be provided when using original Weller parts.

By using genuine Weller parts, you are automatically assured to be operating with the latest and greatest technology in the soldering industry. The Weller R&D Team is constantly testing and developing new techniques to manufacture the ultimate solder tip. Our efforts result in massive savings in time and operating costs for our valued customers.

## How to identify Genuine Weller tips:

### Seal of Quality

The soldering iron and solder tip packaging bears the "Genuine Weller Seal of Quality."

### Tip Engraving

All original Weller tips are now engraved with the Weller logo and tip part numbers.\*  
Only engraved Weller tips guarantee our highest quality standards.  
\*Effective August 2013



## Precise power, control, and balance.

Weller soldering tips are designed at our world class R&D Center in Germany to meet the latest demands of the market. The Weller soldering tip and high power heating element are combined to form a homogeneous and near "perfect" heating system, providing operators with the highest quality solder joints. Combined with an ergonomically designed iron, this technology offers the "perfect" soldering tool.

Every Weller tip is designed to master a specific application.



High-quality copper optimizes heat transfer to the solder joint.

Galvanized iron coating, maximizes the lifetime of the soldering tip.

Using high-quality, lead-free alloys enhances wettability and prevents oxidation.

Corrosion-resistant nickel coating, bonds the iron layer with the exterior chrome plating.

Premium chrome plating, limits the wetting area for a perfectly defined joint contact.

# Three heater/tip technologies designed to master ALL soldering applications—from the most delicate to the most difficult.



## Active (Integral) Tip Technology

This highly-innovative technology offers ultra precise heating and temperature control specifically designed for micro-soldering applications. The fully-integrated tip cartridge delivers the fastest recovery on the market for fine tips at just a slightly higher tip price. Temperature sensitive and miniature applications are mastered with precision and safety.

- Ultra precise performance
- Extremely accurate tip temperature
- Micro-soldering at its finest
- Fastest heat up and recovery time of all three technologies



- Fastest heat up and recovery on the market
- Excellent reaction time with finest tips
- Optimal for soldering under microscopes
- Rapid hot tip-change; no tool required



RT / RTW

Most delicate and temperature-sensitive applications; for use under microscope; ultra fine tips with fastest heat response and best temp-control; cartridge tips.

RT

WXMP-MS  
WMRP/WMRP-MS



Micro-slim soldering iron; Ideal for microscope work.

RTW

WXMT-MS  
WMRT/WMRT-MS



Micro-tweezers; Ideal for soldering and desoldering very small SMD components.



## Power-Response Technology

The newly improved technology maximizes soldering performance on the most-delicate to the most-difficult applications. A perfect balance between power, response, temperature control and lower tip costs makes this unique technology the most attractive solution for top quality professional soldering designed to meet the highest industry standards.

- Maximum power and response for top performance
- Optimal balance between power, control and operating costs with widest range of tips
- Highest quality soldering standard for wide range of applications



- Maximum power and rapid response
- Optimized sensor position
- Meeting highest industry standards
- Wide tip range with low price point

XNT

SMDs and THTs with very small solder pads and increased heat demand, lower cost, non-cartridge style tips.

XNT

WXP65  
WP65



XT / XHT

Most difficult, high-mass soldering jobs; maximum power with ergonomic iron handle, lower cost, non-cartridge style tips.

XT

WXP120  
WP120



Highest standard performance iron with optimum heating power. Soldering applications from small to large components with higher heat demand required.

XHT

WXP200  
WP200



Highest power soldering iron; ideal for applications with highest mass applications e.g. LED back-panels or RF shields.







# Silver-Line Technology

The low-mass copper tips offer the absolute best heat transfer at the lowest price in our entire range of tips. The **80W** ergonomically designed heating element and pencil type grip make this technology the top performer for universal soldering applications where tip price is a deciding factor.

- Ultra precise performance
- Extremely accurate tip temperature
- Micro- to macro-soldering at its finest



LT

Universal SMD and THT applications both small and large; low mass silver tips offer absolute best heat transfer at lowest price in entire tip range; non-cartridge style tips.

LT

WSP80  
WP80



80W, 24V



Effective heat transfer via silver core  
Fast ramp up and recovery  
Designed for universal applications



# Weller heating technologies deliver precise power.

## Three Tip Technologies



Soldering iron



The soldering tip transfers the heat to the solder joint.

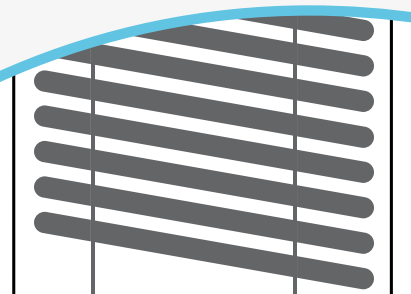

Required heat demand

Power-Response  
Silver-Line

Active-Tip

XNT  
XT  
LT

Solder pad size and joint mass

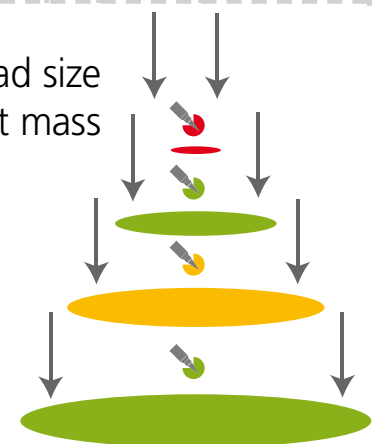

Weller heating and tip technologies are designed for specific applications which provide maximum flexibility. No other soldering iron manufacturer in the world offers this much.

Only Weller supplies three different heating and tip technologies to ensure customers always have the absolute best tool for their specific application. Weller's proven technology enables users to finally tackle those difficult or near impossible hand soldering applications. **We help you get your soldering job done better, faster and cheaper!**

Distance from sensor to solder point

• Sensor position

- Silver-Line
  - Fast-Response
  - Active-Tip
- Solder point

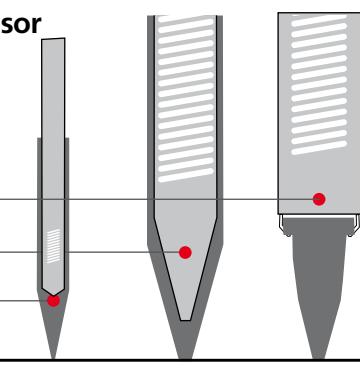

## Maximum flexibility

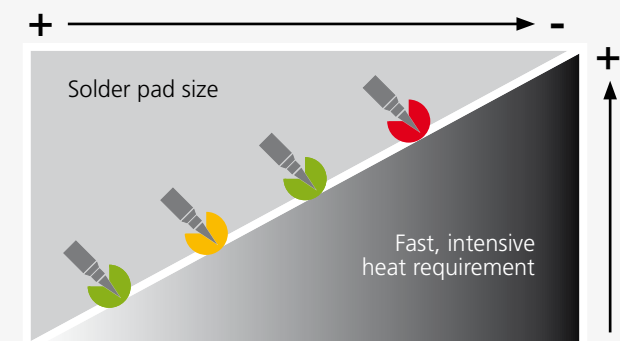



# WMRP/WXMP/WMRP-MS/WXMP-MS

Ideal for microscope work; highest performance via active soldering tip; cartridge type tip.

55W Max, 12V



Fastest heat up and recovery on the market  
Excellent reaction time with finest tips  
Optimal for soldering under microscope  
Rapid hot tip-change; no tool required

WMRP	T0052917199
WMRP-MS	T0052919299
WXMP	T0052920399
WXMP-MS	T0052921399

## Chisel

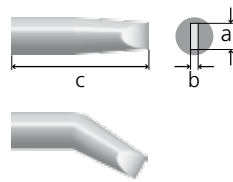

RT	Ø a mm	b mm	Order number
RT 1SC	0.4	0.15	T0054461299
RT 1SCNW*	0.3	0.1	T0054462699
RT 3	1.3	0.4	T0054460399
RT 4	1.5	0.4	T0054460499
RT 8	2.2	0.4	T0054460899
RT 9	0.8	0.4	T0054460999
RT 11	3.6	0.9	T0054461199
RT 5 30°	0.8	0.4	T0054460599

RT-MS	Ø a mm	b mm	Order number
RT 1SCMS	0.4	0.15	T0054461599
RT 1SCNWMS*	0.3	0.1	T0054462671
RT 3MS	1.3	0.4	T0054461699
RT 4MS	1.5	0.4	T0054461899
RT 8MS	2.2	0.4	T0054462299
RT 9MS	0.8	0.4	T0054462399
RT 11MS	3.6	0.9	T0054463199
RT 5MS 30°	0.8	0.4	T0054461999
RT 3XMS 30°	1.3	0.5	T0054460373

## Sloped



Type	a mm	Order number
RT 6 45°	1.2	T0054460699

Type	a mm	Order number
RT 6MS 45°	1.2	T0054462099

MS tips: separate ground

\* non wettable

## Conical



RT	Ø a mm	Order number
RT 1	0.2	T0054460199
RT 1NW*	0.1	T0054462599
RT 2	0.8	T0054460299
RT 15	.75	T0054460271

RT-MS	Ø a mm	Order number
RT 1MS	0.2	T0054461499
RT 1NWMS*	0.1	T0054462571
RT 2MS	0.8	T0054461799
RT 12MS 25°	0.5	T0054463299
RT 13MS 30°	0.4	T0054463399
RT 14MS	0.4	T0054460173
RT 15MS	.75	T0054460273

## Gull wing

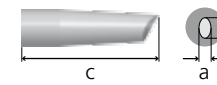

Type	Ø a mm	b mm	Order number
RT10GW	1.2	2.0	T0054461099

Type	Ø a mm	b mm	Order number
RT10GWMS	1.2	2.0	T0054462499

## Knife



Type	Ø a mm	Order number
RT 7 45°	2.2	T0054460799

Type	Ø a mm	Order number
RT 7MS 45°	2.2	T0054462199

MS tips: separate ground

## Measuring tip

Type	Order number
Measuring tip	K1101

\* non-wettable





## WXMT/WMRT/WXMT-MS/WMRT-MS

Ultra slim tweezers; ideal for soldering and desoldering very small SMD components; cartridge type tips.

2 x 40W, 12V



Fastest heat up and recovery on the market  
Excellent reaction time with finest tips  
Optimal for soldering under microscope  
Rapid hot tip-change; no tool required

WMRT	T0051317299
WMRT-MS	T0051317599
WXMT	T0051317799
WXMT-MS	T0051317999

RTW = tweezers

Chisel



RTW	Ø a mm	b mm	Order number
RTW 2 45°	0.7	0.4	T0054465299
RTW 3 45°	3.0	1.0	T0054465399
RTW 4 45°	6.0	1.0	T0054465499
RTW 9	3.0	1.0	T0054466699 <span>NEW</span>
RTW 11	6.0	1.0	T0054466799 <span>NEW</span>
RTW10	10.0	1.0	T0054466899 <span>NEW</span>
RTW 8	1.3	0.4	T0054466499 <span>NEW</span>

RTW-MS	Ø a mm	b mm	Order number
RTW 2MS45°	0.7	0.4	T0054465799
RTW 3MS 45°	3.0	1.0	T0054465899
RTW 4MS 45°	6.0	1.0	T0054465999
RTW 9MS	3.0	1.0	T0054466999 <span>NEW</span>
RTW 11MS	6.0	1.0	T0054467099 <span>NEW</span>
RTW10MS	10.0	1.0	T0054467199 <span>NEW</span>
RTW 8MS	1.3	0.4	T0054466599 <span>NEW</span>
RTW 7NWMS*	0.8	0.4	T0054466371 <span>NEW</span>

Conical



Type	Ø a mm	Order number
RTW 1 45°	0.4	T0054465199
RTW 6NW* 45°	0.2	T0054465699

Type	Ø a mm	Order number
RTW 1MS 45°	0.4	T0054465599
RTW 6NWMS* 45°	0.2	T0054465671

MS tips: separate ground

\* non wettable



## WXP65/WP65

Perfect choice where Active-Tip above lacks sufficient power; lower cost, non-cartridge style tips.

65W, 24V



Maximum power and rapid response  
Optimized sensor position  
Meeting highest industry standards

WXP65	T0052921199
WP65	T0052921599

Chisel



XNT	Ø a mm	b mm	c mm	Order number
XNT 1SCNW*	0.3	0.1	27.0	T0054488199 <span>NEW</span>
XNT 1SC	0.4	0.15	27.0	T0054486299
XNT H	0.8	0.4	28.0	T0054485999
XNT K	1.2	0.4	28.0	T0054486099
XNT A	1.6	0.4	28.0	T0054485199
XNT 6	1.6	0.4	29.5	T0054485699
XNT B	2.4	0.8	27.0	T0054485799

Sloped



Type	a mm	Order number
XNT 4 45°	1.2	T0054485599
XNT AA 45°	1.6	T0054488499 <span>NEW</span>
XNT BB 45°	2.4	T0054488599 <span>NEW</span>

Type	Ø a mm	b mm	c mm	Order number
XNT C	3.2	0.8	27.0	T0054485899
XNT D	4.0	0.8	28.0	T0054485399
XNT HX 45°	0.8	0.4	36.5	T0054487399
XNT 4X 45°	1.2	0.4	34.6	T0054487499
XNT AX 45°	1.6	0.8	28.0	T0054486499
XNT BX 45°	2.4	0.8	36.5	T0054488299 <span>NEW</span>
XNT MX 45°	3.2	0.8	37.5	T0054488399 <span>NEW</span>

Type	a mm	Order number
XNT CC 45°	3.2	T0054488699 <span>NEW</span>
XNT F 45°	1.2	T0054488799 <span>NEW</span>

\* non-wettable





### Conical



XNT		Ø a mm	c mm	Order number
XNT 1		0.5	27.0	T0054485099
XNT 1L		.02	42.8	T0054487199

### Knife



Type	Ø a mm	c mm	Order number
XNT KN	2.0	33.0	T0054486399

### Gull wing



Type	b mm	c mm	Order number
XNT GW 45°	2.0	33.0	T0054485499

### Round

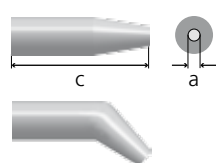

Type	Ø a mm	c mm	Order number
XNT 1S	0.2	28.5	T0054485299
XNT AS	1.6	29.5	T0054486999
XNT L	2.0	37.5	T0054486699
XNT CS	3.2	29.5	T0054487099

### SMT

Type	Ø a mm	b mm	c mm	Order number
XNT SMT 01	10.4	0.6	7.1	T0054487699
XNT SMT 02	16.8	0.6	7.1	T0054487799

### Accessories

Type	Ø a mm	c mm	Order number
Measuring tip			K1131
XNT Screw M4		26.0	T0054487999

\* non wettable

Type	Ø a mm	c mm	Order number
XNT S	0.4	37.5	T0054486899

Type	b mm	c mm	Order number
XNT GW 1 45°	1.5	27.5	T0054488099

Type	Ø a mm	c mm	Order number
XNT M	3.2	37.5	T0054486799
XNT 1LX 45°	0.2	36.5	T0054487299
XNT 1X 45°	0.4	28.0	T0054486599
XNT 1SLX 45°	0.4	39.5	T0054487599

Type	Ø a mm	b mm	c mm	Order number
XNT SMT 03	20.8	0.6	7.1	T0054487899

Type	Order number
Barrel	T0058765758
Barrel for bent tips	T0058765767



## WSP80/WP80

Universal SMD and THT applications both small and large; lowest cost, non-cartridge style tips in entire range.

80W, 24V



Effective heat transfer via best material silver core  
Fast ramp up and recovery  
Designed for universal applications

WSP80  
WP80

WSP80  
T0052918099

### Chisel



LT		Ø a mm	b mm	c mm	Order number
LT 1SC		0.4	0.15	15.0	T0054449499
LT 1SCNW*		0.3	0.1	15.0	T0054449799
LT A		1.6	0.7	12.5	LT A
LT ASL		1.6	0.45	12.5	T0054451699
LT B		2.4	0.8	12.5	LT B
LT BSL		2.4	0.45	12.5	T0054451799
LT H		0.8	0.4	12.5	LT H
LT HSL		0.8	0.4	12.5	T0054451899
LT C		3.2	0.8	12.5	LT C
LT D		4.6	0.8	12.5	LT D

### Round

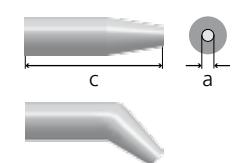

Type	Ø a mm	c mm	Order number
LT 1S	0.2	15.0	LT 1S
LT 1SNW*	0.1	15.0	T0054449699
LT 1SA	0.5	15.0	T0054448899
LT 1	0.25	13.0	LT 1
LT 1LNW*	0.1	25.4	T0054449899

\* non-wettable

Type	Ø a mm	b mm	c mm	Order number
LT DLL	4.6	1.2	12.5	T0054444899
LT K	1.2	0.4	20.0	LT K
LT L	2.0	1.0	20.0	LT L
LT M	3.2	1.2	20.0	LT M
LT HX 30°	0.8	0.4	17.5	LT HX
LT ALX 30°	1.6	0.7	17.5	LT ALX
LT BX 30°	2.4	0.8	17.5	T0054444299
LT AX 30°	1.6	0.8	14.1	LT AX
LT 4X 30°	1.2	0.4	17.2	LT 4X
LT MX 30°	3.2	1.2	20.0	T0054446999

Type	Ø a mm	c mm	Order number
LT 1A	0.5	13.0	T0054448999
LT AS	1.6	12.5	LT AS
LT CS	3.2	12.5	LT CS
LT 1SLX 30°	0.4	22.0	LT 1SLX
LT 1X 30°	0.4	13.0	LT 1X





### Knife

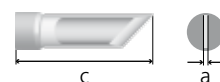

LT		Ø a mm	c mm	Order number
LT KN		2.0	16.5	LTKN
LT KN SL 45°		2.0	16.5	T0054451999

### Sloped

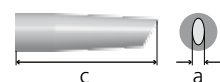

Type	a mm	c mm	Order number
LT 4 45°	1.2	15.0	T0054443999
LT F 45°	1.2	12.5	LTF
LT AA 60°	1.6	12.5	LTAA60SK1407
LT BB 60°	2.4	17.0	T0054444499
LT BB 45°	2.4	17.0	T0054448499
LT CC 60°	3.2	17.0	T0054444599
LT CC 45°	3.2	17.0	T0054448599

### Conical



Type	Ø a mm	c mm	Order number
LT 1L	0.2	25.4	LT1L
LT 1LNW*	0.1	25.4	T0054449899
LT S	0.4	21.0	LTS

### Gull wing

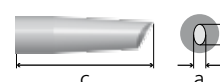

Type	Ø a mm	b mm	c mm	Order number
LT GW1 45°	2.3	3.2	17.8	LGTW
LT GW2 45°	3.5	4.8	17.8	T0054451199

### Accessories

Type	a mm	c mm	Order number
Measuring tip WSP80			K181
Screw M4 external thread	8.0		T0054444999
ET-LT Adapter			T0058720781

\* non wettable

Type	a mm	c mm	Order number
LT DD 45°	4.0	20.0	T0054447899
LT DD 45° A	4.6	17.0	T0054448699
LT 11CP 45°	1.2	15.0	T0054442171
LT 22CP 45°	2.0	20.0	T0054440873
LT 33CP 45°	3.0	20.0	T0054440877
LT 44CP 45°	4.0	20.0	T0054440881

Type	Ø a mm	c mm	Order number
LT T	0.6	13.0	T0054448299
LT O	0.8	17.0	T0054448199
LT 1LX 35°	0.2	25.4	LT1LX



## WXP120/WP120

120 watt highest standard performance iron; perfect choice, lower cost, non-cartridge style tips.

120W, 24V



Maximum power and rapid response  
Optimized sensor position  
Meeting highest industry standards

WXP120 T0052920199  
WP120 T0052919399

### Chisel

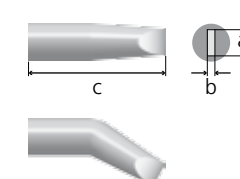

XT		Ø a mm	b mm	c mm	Order number
XT H		0.8	0.4	36.5	T0054471399
XT M		3.2	1.2	36.0	T0054470299
XT A		1.6	0.7	36.5	T0054470399
XT AL		1.6	1.0	39.5	T0054470199
XT ASL		1.6	0.45	36.5	T0054474099
XT M		3.2	1.2	39.5	T0054470299
XT B		2.4	0.8	36.0	T0054470499
XT B SL		2.4	0.45	36.0	T0054474199
XT B SL		2.5	0.8	36.3	T0054473899
XT C		3.2	0.8	36.0	T0054470599

### Round

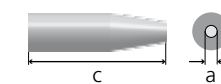

Type	Ø a mm	c mm	Order number
XT BS	2.4	36.5	T0054471599
XT CS	3.2	36.5	T0054471699

### Sloped

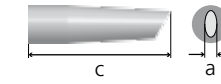

Type	a mm	c mm	Order number
XT F 30°	1.2	36.5	T0054471899
XT AA 60°	1.6	36.5	T0054470899
XT BB 45°	2.4	36.5	T0054470999
XT CC 45°	3.2	36.5	T0054471099

\* non-wettable

Type	Ø a mm	b mm	c mm	Order number
XT D	4.6	0.8	34.5	T0054470699
XT CSL	3.2	0.45	36.0	T0054474299
XT E	5.9	1.2	34.5	T0054470799
XT DL	4.6	0.8	39.5	T0054473699
XT MX	3.2	0.8	53.5	T0054474599
XT HX	0.8	0.4	51.5	T0054473799
XT AX 30°	1.6	0.7	51.5	T0054474399
XT BX 30°	2.4	0.8	51.5	T0054474499

Type	Ø a mm	c mm	Order number
XT DS	5.0	34.5	T0054471799

Type	a mm	c mm	Order number
XT DDH 45 45°	4.0	40.5	T0054473099
XT D 45°	5.0	40.5	T0054472199
XT AA 60°	1.6	36.5	T0054470899







### Gull wing



XT		Ø a mm	b mm	c mm	Order number
	XT GW1 45°	2.3	3.2	36.5	T0054471299
	XT GW2 45°	3.5	4.8	36.5	T0054473599

Type	Ø a mm	b mm	c mm	Order number
	0.8	0.9	41.5	T0054473999

### Knife

Type	Ø a mm	c mm	Order number
	2.0	45.0	T0054471199

### Conical



Type	Ø a mm	c mm	Order number
	1.0	36.5	T0054471499

### Accessories

Type	a mm	c mm	Order number
Measuring tip (For the WP120)			K1121
Measuring tip (For the WXP120)			K1141
XT Adapter M4		36.0	T0054471999
XT Adapter M5		36.0	T0054472099

Type	Order number
Barrel	WXP 120 WP 120 T0058765711 T0058763709
Barrel for bent tips	WXP 120 WP 120 T0058765766 T0058765802

Maximum power and rapid response  
Optimized sensor position  
Meeting highest industry standards



## WXP200/WP200

**Highest power 200W** soldering iron; ideal for highest mass applications e.g. LED back-panels or RF shields.

200W, 24V



### Chisel



XHT		Ø a mm	b mm	c mm	Order number
	XHT C	3.2	1.2	48.0	T0054480499
	XHT D	5.0	1.2	48.0	T0054480199

Type	Ø a mm	b mm	c mm	Order number
	7.6	1.5	48.0	T0054480299
	9.3	2.0	48.0	T0054480599

Custom tips available upon request.



# Why Weller dry cleaning?

- Excellent cleaning results
- Soldering tip is cleaned yet remains wetted
- Aggressive flux residues are removed
- Prevents oxidation of the soldering tip
- Low temperature shock-vs-wet sponge
- Helps extend soldering tip lifetime



## Weller WDC/WDC2 Dry Cleaner



Dry cleaner with brass or steel wool—recommended for dry cleaning of soldering tips using the WDC dry cleaner with brass wool. The solder tip is cleaned and flux residues are removed while tip remains wetted.  
Order number: T0051512499-WDC  
T0051512599-WDC2



Find out how to use the WDC dry cleaner correctly on our youtube channel: visit [www.youtube.com/wellersoldering](http://www.youtube.com/wellersoldering)



## WPB1 Cold-Tip Polishing Bar



Cleans and renews the soldering tip surface. Clean the tip only when it is COLD to prevent tip damage.  
Order number: WPB1

## Weller Hot-Tip Activator



For re-activation or re-wetting of dark, oxidized soldering tip, clean the tip in the activator while the tip is still HOT.  
Order number: T0051303199

## WHP20 Preheating Plate



Supplies additional heat energy to the PCB being soldered. This protects the board from partial overheating and allows the use of much lower, safer solder tip temperatures. Extended tip lifetime is the cost benefit.  
Order number: WHP200

## Tip Recycle Box



Weller Tip Recycling Box for two rounds of used tips.  
Order number: T550729

# How to extend the lifetime of your original Weller soldering tips.

The critical quality component in a soldering process is the soldering tip—which must transfer heat to the joint effectively and reliably. Improper care of the tips can result in quality loss and costly soldering issues. To prevent such problems and unnecessary waste, original Weller products and tips are recommended at all times.

Weller WD, WR, and WX series stations as well as the Stop & Go Safety Rest enable you to use devices in standby mode to protect the soldering tip and save energy.



Weller tips and accessories



\*LED Light Ring



Standby/auto-off



Stop & Go Safety Rest with dry cleaner accessories

# Weller®

\*Automatic Energy Saving Mode with visual process control via blue LED light ring. (Light on = heater on, light off = heater off)

# Resources for the future.

## CARE ABOUT THE ENVIRONMENT?

Weller does and we want you to work with us to make it better.

Weller is a committed supporter of actions that help to protect our environment and to conserve its natural resources.

To this end, Weller is launching a recycling initiative for old, used soldering tips. By recycling the copper and iron from used tips, we can make a real contribution towards helping the environment and preserving its natural resources.

## HOW IT WORKS:

In the United States? We want you to collect your worn out soldering tips, all types from all manufacturers, send them to us and we will arrange for their environmentally safe recycling.

This will benefit the environment but it will also benefit you because for every 2 lbs. of worn out tips you send to us you will receive a \$75.00 voucher to be used against your next purchase of Weller Brand tips.

Get involved with Weller and the environment will profit and so will you.

Please send the full TIP RECYCLING BOX to the address on the box or to:  
Weller Tools  
1000 Lufkin Road  
Apex, NC 27539 USA



Need a new box? Contact us.



# Weller®

#### USA

Apex Tool Group, LLC  
100 Lufkin Road  
Apex, NC 27539  
Tel: +1 (800) 688 8949  
Fax: +1 (800) 234 0472

#### CANADA

Apex Tools – Canada  
7361 Bath Road  
Mississauga, Ontario L4 3T1  
Tel: +1 (905) 673 4400  
Fax: +1 (905) 673 4408

#### GERMANY

Weller Tools GmbH  
Carl-Benz-Straße 2  
74354 Besigheim  
Tel: +49 (0)7143 580-0  
Fax: +49 (0)7143 580-108

#### GREAT BRITAIN

Apex Tool Group (UK Operations)  
Ltd  
4th Floor Pennine House  
Washington, Tyne & Wear  
NE37 1LY  
Tel: +44 (0) 191 419 7700  
Fax: +44 (0) 191 417 9421

#### FRANCE

Apex Tool Group S.N.C.  
25 Avenue Maurice Chevalier B.P. 46  
77832 Ozoir-la-Ferrière Cedex  
Tel: +33 (0) 1.64.43.22.00  
Fax: +33 (0) 1.64.43.21.62

#### ITALY

Apex Tool S.r.l.  
Viale Europa 80  
20090 Cusago (MI)  
Tel: +39 (02)9033101  
Fax: +39 (02)90394231

#### SWITZERLAND

Apex Tool Switzerland Sàrl  
Rue de la Roselière 12  
1400 Yverdon-les-Bains  
Tel: +41 (0) 24 426 12 06  
Fax: +41 (0) 24 425 09 77

#### CHINA

Apex Tool Group  
A-8 building  
No. 38 Dongsheng Road  
Heqing Industrial Park, Pudong  
Shanghai PRC 201201  
Tel: +86 (21)60880288  
Fax: +86 (21)60880289

#### AUSTRALIA

Apex Tools  
P.O. Box 366  
519 Nurigong Street  
Albury, N.S.W. 2640  
Australia  
Tel: +61 (2)6058-0300  
Fax: +61 (2)6021-7403

#### SOUTH EAST ASIA

Apex Power Tools India Pvt Ltd  
Gala No. 1, Plot No. 5  
S.No. 234, 235 & 245  
India land Global Industrial Park.  
(Next to Tata Johnson Control)  
Taluka- Mulsi , Phase -I  
Hinjawadi Pune (411057)  
Maharashtra, India  
toolsindia@apextoolgroup.com

[weller-tools.com](http://weller-tools.com)

© 2013 Apex Tool Group, LLC | 1000 Lufkin Road | Apex, NC 27539 | [weller-na@weller-tools.com](mailto:weller-na@weller-tools.com)

ATG-1388 | ITEM No. T550879 | 7.5m 6/13 CG | Specifications subject to change without notice.





Компания «Life Electronics» занимается поставками электронных компонентов импортного и отечественного производства от производителей и со складов крупных дистрибьюторов Европы, Америки и Азии.

С конца 2013 года компания активно расширяет линейку поставок компонентов по направлению коаксиальный кабель, кварцевые генераторы и конденсаторы (керамические, пленочные, электролитические), за счёт заключения дистрибьюторских договоров

Мы предлагаем:

- Конкурентоспособные цены и скидки постоянным клиентам.
- Специальные условия для постоянных клиентов.
- Подбор аналогов.
- Поставку компонентов в любых объемах, удовлетворяющих вашим потребностям.
- Приемлемые сроки поставки, возможна ускоренная поставка.
- Доставку товара в любую точку России и стран СНГ.
- Комплексную поставку.
- Работу по проектам и поставку образцов.
- Формирование склада под заказчика.
- Сертификаты соответствия на поставляемую продукцию (по желанию клиента).
- Тестирование поставляемой продукции.
- Поставку компонентов, требующих военную и космическую приемку.
- Входной контроль качества.
- Наличие сертификата ISO.

В составе нашей компании организован Конструкторский отдел, призванный помогать разработчикам, и инженерам.

Конструкторский отдел помогает осуществить:

- Регистрацию проекта у производителя компонентов.
- Техническую поддержку проекта.
- Защиту от снятия компонента с производства.
- Оценку стоимости проекта по компонентам.
- Изготовление тестовой платы монтаж и пусконаладочные работы.



Тел: +7 (812) 336 43 04 (многоканальный)  
Email: [org@lifeelectronics.ru](mailto:org@lifeelectronics.ru)