



Technical Data Sheet

1.5mm Side Face Infrared LED

IR908-7C-F

Features

- High reliability
- High radiant intensity
- Peak wavelength $\lambda_p=940\text{nm}$
- 2.54mm Lead spacing
- Low forward voltage
- Pb free
- This product itself will remain within RoHS compliant version.



Descriptions

- EVERLIGHT's Infrared Emitting Diode (IR908-7C-F) is a high intensity diode, molded in a water clear plastic package.
- The miniature side-facing device has a chip, that emits radiation from the side of the clear package.

Applications

- Mouse
- Optoelectronic switch
- Infrared applied system

Device Selection Guide

LED Part No.	Chip	Lens Color
	Material	
IR908-7C-F	GaAlAs	Water clear

Package Dimensions

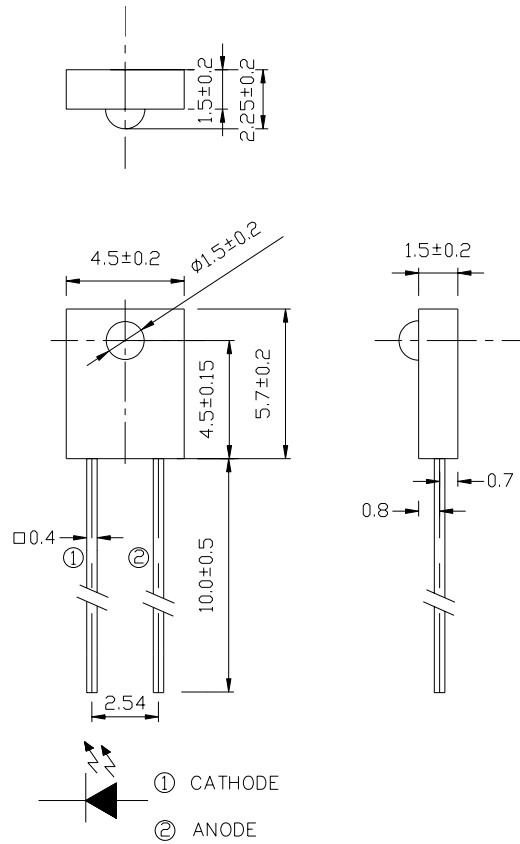

- Notes:** 1.All dimensions are in millimeters
 2.Tolerances unless dimensions $\pm 0.25\text{mm}$

Absolute Maximum Ratings (Ta=25°C)

Parameter	Symbol	Rating	Units
Continuous Forward Current	I_F	50	mA
Peak Forward Current	I_{FP}	1.0	A
Reverse Voltage	V_R	5	V
Operating Temperature	T_{opr}	-25 ~ +85	°C
Storage Temperature	T_{stg}	-40 ~ +85	°C
Soldering Temperature	T_{sol}	260	°C
Power Dissipation at(or below) 25°C Free Air Temperature	P_d	75	mW

- Notes:** *1: I_{FP} Conditions--Pulse Width $\leq 100 \mu s$ and Duty $\leq 1\%$.
 *2:Soldering time ≤ 5 seconds.

Electro-Optical Characteristics (Ta=25°C)

Parameter	Symbol	Condition	Min.	Typ.	Max.	Units
Light Current	I _{c(on)}	I _F =4mA, V _{CE} =3.5V	143	--	1274	μA
Peak Wavelength	λ _p	I _F =20mA	--	940	--	nm
Spectral Bandwidth	Δλ	I _F =20mA	--	45	--	nm
Forward Voltage	V _F	I _F =20mA		1.2	1.5	V
Reverse Current	I _R	V _R =5V	--	--	10	μA
View Angle	2θ 1/2	I _F =20mA	--	60	--	deg

Rank

Color Code	Ranks	Symbol	Min	Typ	Max	Unit	Test Condition
Red	E1	I _{c(on)}	143	---	255	μA	I _F =4mA, V _{CE} =3.5V
Blue	E2	I _{c(on)}	214	---	343	μA	I _F =4mA, V _{CE} =3.5V
Yellow	E3	I _{c(on)}	286	---	431	μA	I _F =4mA, V _{CE} =3.5V
Silver	E4	I _{c(on)}	357	---	519	μA	I _F =4mA, V _{CE} =3.5V
Green	E5	I _{c(on)}	428	---	608	μA	I _F =4mA, V _{CE} =3.5V
Purple	E6	I _{c(on)}	500	---	696	μA	I _F =4mA, V _{CE} =3.5V
White	E7	I _{c(on)}	571	---	784	μA	I _F =4mA, V _{CE} =3.5V

Rough ranks

Parameter	Min	Max	Unit	Test Condition
7-2	306	441	μA	I _F =4mA, V _{CE} =3.5V
7-1	347	550	μA	I _F =4mA, V _{CE} =3.5V
6-2	465	750	μA	I _F =4mA, V _{CE} =3.5V
6-1	650	1274	μA	I _F =4mA, V _{CE} =3.5V

Typical Electro-Optical Characteristics Curves

Fig.1 Forward Current vs. Ambient Temperature

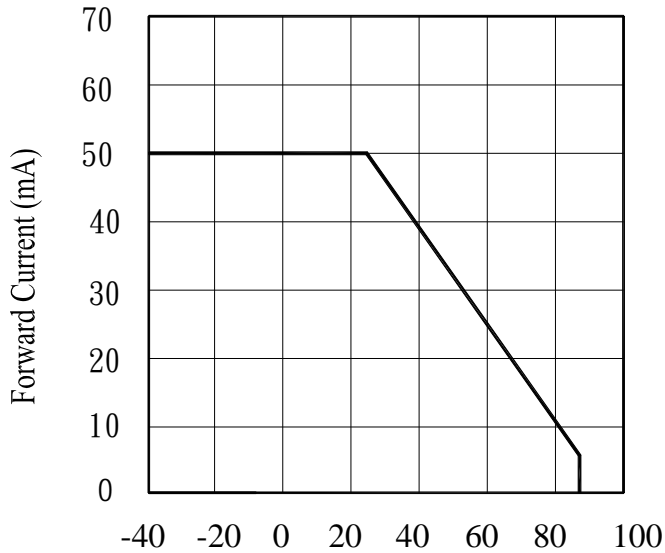

Fig.2 Spectral Distribution

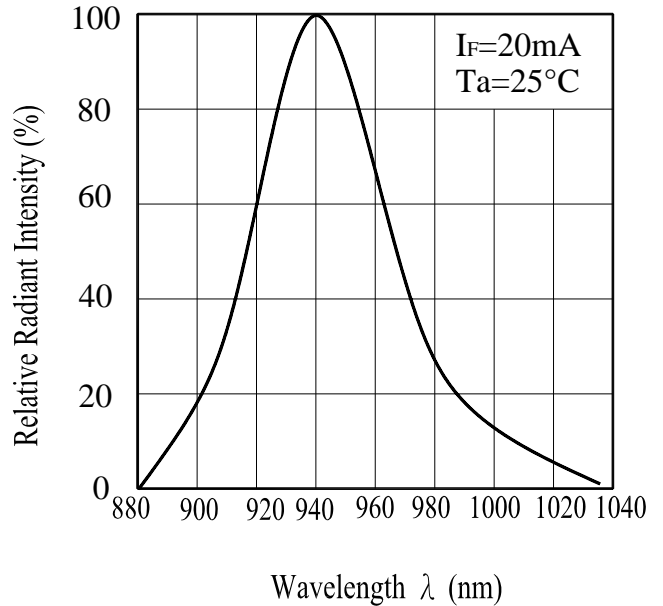

Fig.3 Peak Emission Wavelength vs. Ambient Temperature

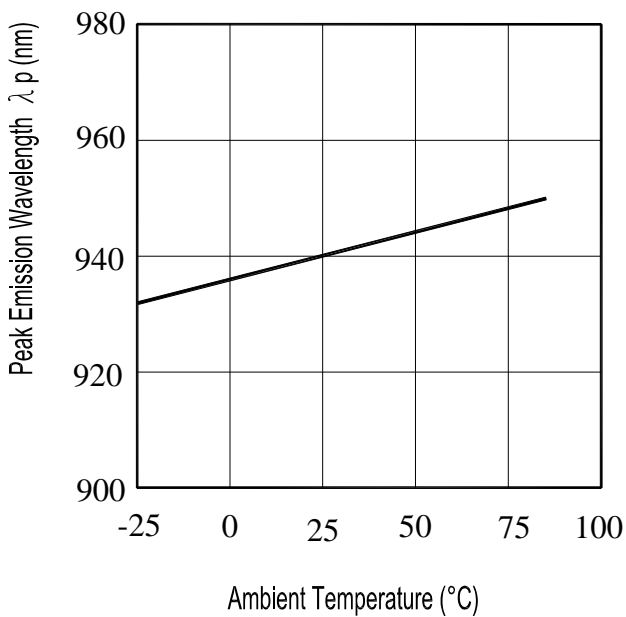
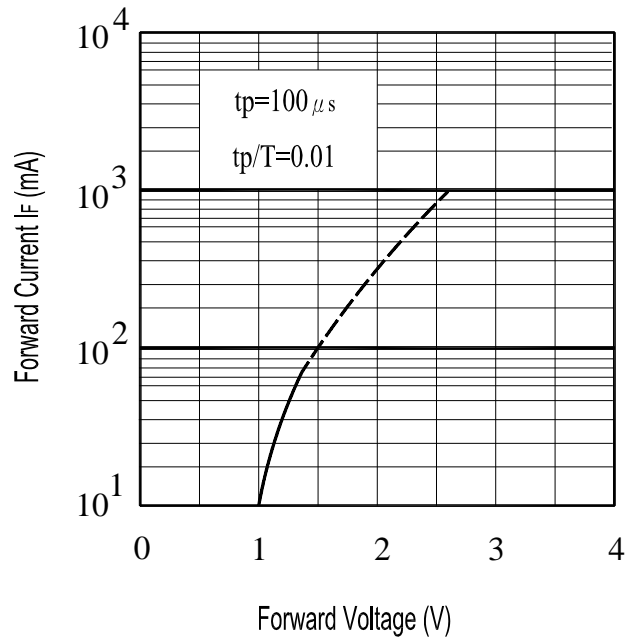

Fig.4 Forward Current vs. Forward Voltage



Typical Electro-Optical Characteristics Curves

Fig.8 Forward Current vs. Ambient Temperature(°C)

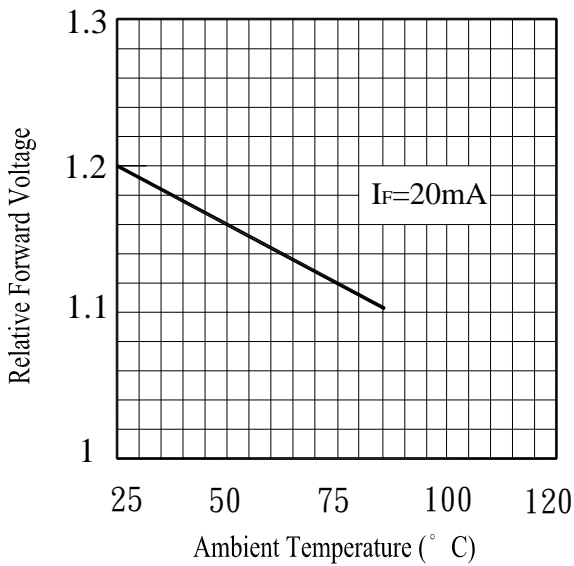
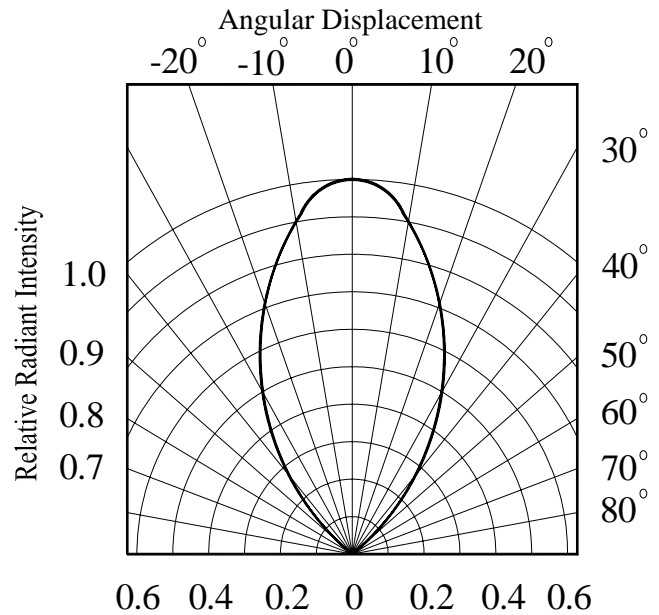

Fig.6 Relative Radiant Intensity vs. Angular Displacement



Test Method For $I_{C(ON)}$:

Condition: $I_F=4mA, V_{CE}=3.5V$



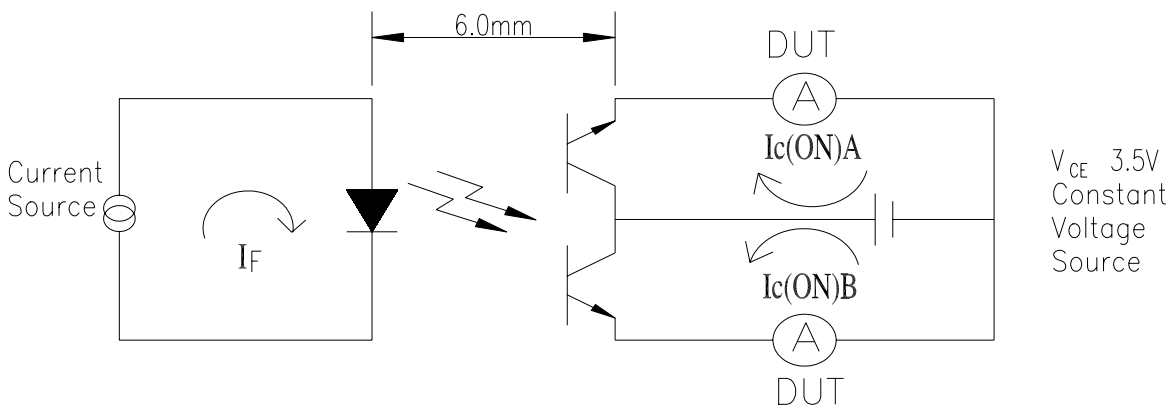

The intensity testing method for infrared emitting diode



Packing Quantity Specification

- 1. 1000PCS/1Bag,10Bag/1Box
- 2. 10Boxes/1Carton

Label Form Specification

		
CPN:		CPN: Customer's Production Number
P/N:		P/N : Production Number
		QTY: Packing Quantity
IR908-7C-F		CAT: Ranks
QTY:		HUE: Peak Wavelength
LOT NO:		REF: Reference
		LOT No: Lot Number

Notes

- 1. Above specification may be changed without notice. EVERLIGHT will reserve authority on material change for above specification.
- 2. When using this product, please observe the absolute maximum ratings and the instructions for using outlined in these specification sheets. EVERLIGHT assumes no responsibility for any damage resulting from use of the product which does not comply with the absolute maximum ratings and the instructions included in these specification sheets.
- 3. These specification sheets include materials protected under copyright of EVERLIGHT corporation. Please don't reproduce or cause anyone to reproduce them without EVERLIGHT's consent.

EVERLIGHT ELECTRONICS CO., LTD. Office: No 25, Lane 76, Sec 3, Chung Yang Rd, Tucheng, Taipei 236, Taiwan, R.O.C	Tel: 886-2-2267-2000, 2267-9936 Fax: 886-2267-6244, 2267-6189, 2267-6306 http://www.everlight.com
---	--

Компания «Life Electronics» занимается поставками электронных компонентов импортного и отечественного производства от производителей и со складов крупных дистрибьюторов Европы, Америки и Азии.

С конца 2013 года компания активно расширяет линейку поставок компонентов по направлению коаксиальный кабель, кварцевые генераторы и конденсаторы (керамические, пленочные, электролитические), за счёт заключения дистрибьюторских договоров

Мы предлагаем:

- Конкурентоспособные цены и скидки постоянным клиентам.
- Специальные условия для постоянных клиентов.
- Подбор аналогов.
- Поставку компонентов в любых объемах, удовлетворяющих вашим потребностям.
- Приемлемые сроки поставки, возможна ускоренная поставка.
- Доставку товара в любую точку России и стран СНГ.
- Комплексную поставку.
- Работу по проектам и поставку образцов.
- Формирование склада под заказчика.
- Сертификаты соответствия на поставляемую продукцию (по желанию клиента).
- Тестирование поставляемой продукции.
- Поставку компонентов, требующих военную и космическую приемку.
- Входной контроль качества.
- Наличие сертификата ISO.

В составе нашей компании организован Конструкторский отдел, призванный помогать разработчикам, и инженерам.

Конструкторский отдел помогает осуществить:

- Регистрацию проекта у производителя компонентов.
- Техническую поддержку проекта.
- Защиту от снятия компонента с производства.
- Оценку стоимости проекта по компонентам.
- Изготовление тестовой платы монтаж и пусконаладочные работы.



Тел: +7 (812) 336 43 04 (многоканальный)

Email: org@lifeelectronics.ru