

EAO – Your Expert Partner for
Human Machine Interfaces



EAO Product Information

Series 18



| | |
|--------------------------------------|-----------|
| Description | 3 |
| Product Assembly | 4 |
| Devices raised mounting | 5 |
| Devices flush mounting | 6 |
| Accessories..... | 7 |
| Technical Data..... | 10 |
| Drawings..... | 11 |
| Index..... | 15 |

Product Information

General notes

The series 18 comprises compact indicators for direct connection to 2.2, 12 or 24 VDC and illuminated pushbuttons with maintained or momentary action.

The illuminated pushbuttons are equipped with a snap-action switching system with normally open or normally closed contacts.

The dimensions of the front are 9 x 14 mm, 9 x 9 mm or 9 mm dia. Indicators and illuminated pushbuttons for use with overhanging lenses 14 x 14 mm or 14 mm dia. are also available for flush mounting.

Mounting

Mounting from the front through the mounting hole 8 mm dia. (15.8 x 15.8 mm resp. 16 mm dia. for flush mounting) is assured even with the wiring already attached.

The units are provided with soldering terminals.

Lenses

The flat lenses are available in various colours and a transparent version. The surface is nonreflecting (matt).

Illumination

Perfect illumination of the lenses, which can be supplied in various colours, is assured by Bi-Pin T1 LEDs (2.2 VDC) in the colours red, yellow and green.

(Compact indicators for connection to 12 or 24 VDC.) The Bi-Pin T1 LED are already integrated in the lenses.

Luminosity and wave length scattering caused by the technology used in the LED manufacturing processes may lead to visual differences in our products.

Position indication

The status of a maintained action switch can be determined by the position of the lens.

Specimen order

Illuminated pushbutton :

- Illuminated pushbutton actuator, 9 x14 mm, momentary action, 1 normally open, soldering terminal 18-147.035

Essential accessories :

- Lens with LED plastic yellow, transparent, flush, 9 x 14 mm 18-941.4

We reserve the right to modify technical data

All dimensions in mm

Pushbutton illuminative, raised mounting

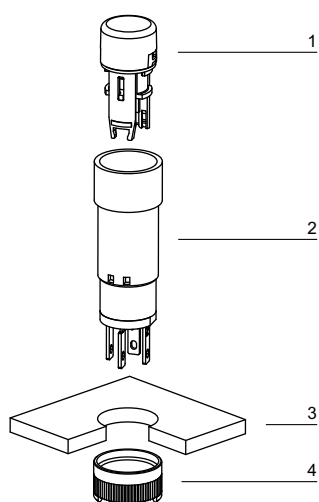

- 1 Lens
- 2 Switch housing
- 3 Front panel
- 4 Fixing nut

Pushbutton illuminative, flush mounting

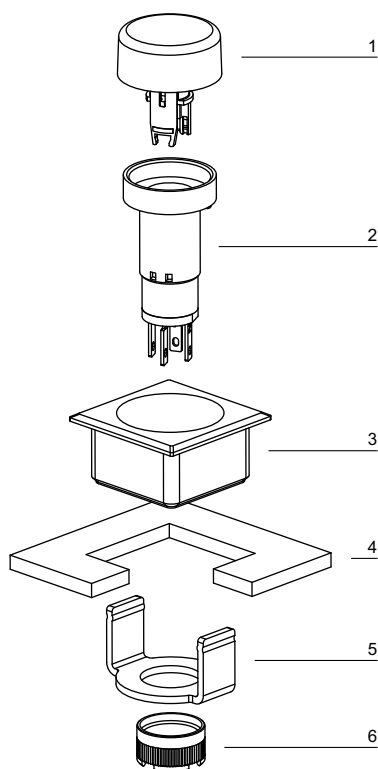

- 1 Lens
- 2 Switch housing
- 3 Front bezel set (upper part)
- 4 Front panel
- 5 Front bezel set (lower part)
- 6 Fixing nut

Indicator



| Indicator | Front protection | Operating voltage/-current | Lens | Terminals | 9 x 9 mm | 9 x 14 mm | Ø 9 mm | Component layout | | | | 0.002 |
|-----------|------------------|----------------------------|----------------|-----------|--------------------|--------------------|--------------------|---------------------|-------------------|-----------------|---|-------|
| | | | | | Typ-Nr. | Typ-Nr. | Typ-Nr. | Mounting dimensions | Technical drawing | Circuit drawing | | |
| Indicator | IP 40 | 12 VDC, 20 mA | Plastic green | S | 18-051.0055 | 18-041.0055 | 18-031.0055 | 1 | 1 | 1 | 1 | 0.002 |
| | | | Plastic red | S | 18-051.0052 | 18-041.0052 | 18-031.0052 | 1 | 1 | 1 | 1 | 0.002 |
| | | | Plastic yellow | S | 18-051.0054 | 18-041.0054 | 18-031.0054 | 1 | 1 | 1 | 1 | 0.002 |
| | | 2.2 VDC, 20 mA | Plastic green | S | 18-050.0055 | 18-040.0055 | 18-030.0055 | 1 | 1 | 1 | 1 | 0.002 |
| | | | Plastic red | S | 18-050.0052 | 18-040.0052 | 18-030.0052 | 1 | 1 | 1 | 1 | 0.002 |
| | | | Plastic yellow | S | 18-050.0054 | 18-040.0054 | 18-030.0054 | 1 | 1 | 1 | 1 | 0.002 |
| | | 24 VDC, 20 mA | Plastic green | S | 18-052.0055 | 18-042.0055 | 18-032.0055 | 1 | 1 | 1 | 1 | 0.002 |
| | | | Plastic red | S | 18-052.0052 | 18-042.0052 | 18-032.0052 | 1 | 1 | 1 | 1 | 0.002 |
| | | | Plastic yellow | S | 18-052.0054 | 18-042.0054 | 18-032.0054 | 1 | 1 | 1 | 1 | 0.002 |

Terminals: S = Soldering terminal

Component layout from page 11, Mounting dimensions from page 12, Technical drawing from page 12, Circuit drawing from page 13

Illuminated pushbutton actuator



Essential Accessories:

Lens with LED page 7

| Illuminated pushbutton actuator | Front protection | Switching system | Contacts | Switching action | Terminals | 9 x 9 mm | 9 x 14 mm | Ø 9 mm | Component layout | | | | 0.002 |
|---------------------------------|------------------|------------------|----------|------------------|-----------|-------------------|-------------------|-------------------|---------------------|-------------------|-----------------|---|-------|
| | | | | | | Typ-Nr. | Typ-Nr. | Typ-Nr. | Mounting dimensions | Technical drawing | Circuit drawing | | |
| Illuminated pushbutton actuator | IP 40 | SA | 1 NC | MA | S | 18-258.035 | 18-248.035 | 18-238.035 | 2 | 1 | 2 | 2 | 0.002 |
| | | | | M | S | 18-158.035 | 18-148.035 | 18-138.035 | 2 | 1 | 2 | 4 | 0.002 |
| | | | 1 NO | MA | S | 18-257.035 | 18-247.035 | 18-237.035 | 2 | 1 | 2 | 3 | 0.002 |
| | | | | M | S | 18-157.035 | 18-147.035 | 18-137.035 | 2 | 1 | 2 | 5 | 0.002 |

Switching system: SA = Snap-action switching element

Contacts: NC = Normally closed, NO = Normally open

Switching action: MA = Maintained action, M = Momentary action

Terminals: S = Soldering terminal

Component layout from page 11, Mounting dimensions from page 12, Technical drawing from page 12, Circuit drawing from page 13

Indicator actuator, flush mounting



Essential Accessories:

Front bezel set, flush mounting page 8

| | Front protection | Operating voltage/-current | Lens | Terminals | □ 19 x 19 mm Typ-Nr. | ∅ 19 mm Typ-Nr. | Component layout | Mounting dimensions | Technical drawing | Circuit drawing | |
|---|------------------|----------------------------|----------------|-----------|-------------------------|--------------------|------------------|---------------------|-------------------|-----------------|-------|
| Indicator actuator, flush mounting | IP 40 | 12 VDC, 20 mA | Plastic green | S | 18-081.0055 | 18-061.0055 | 2 | 2 | 3 | 1 | 0.003 |
| | | | Plastic red | S | 18-081.0052 | 18-061.0052 | 2 | 2 | 3 | 1 | 0.003 |
| | | | Plastic yellow | S | 18-081.0054 | 18-061.0054 | 2 | 2 | 3 | 1 | 0.003 |
| | | 2.2 VDC, 20 mA | Plastic green | S | 18-080.0055 | 18-060.0055 | 2 | 2 | 3 | 1 | 0.002 |
| | | | Plastic red | S | 18-080.0052 | 18-060.0052 | 2 | 2 | 3 | 1 | 0.002 |
| | | | Plastic yellow | S | 18-080.0054 | 18-060.0054 | 2 | 2 | 3 | 1 | 0.002 |
| | | 24 VDC, 20 mA | Plastic green | S | 18-082.0055 | 18-062.0055 | 2 | 2 | 3 | 1 | 0.003 |
| | | | Plastic red | S | 18-082.0052 | 18-062.0052 | 2 | 2 | 3 | 1 | 0.003 |
| | | | Plastic yellow | S | 18-082.0054 | 18-062.0054 | 2 | 2 | 3 | 1 | 0.003 |

Terminals: S = Soldering terminal

Component layout from page 11, Mounting dimensions from page 12, Technical drawing from page 12, Circuit drawing from page 13

Illuminated pushbutton actuator, flush mounting



Essential Accessories:

Front bezel set, flush mounting page 8

Lens with LED, flush mounting page 7

| | Front protection | Switching system | Contacts | Switching action | Terminals | □ 19 x 19 mm Typ-Nr. | ∅ 19 mm Typ-Nr. | Component layout | Mounting dimensions | Technical drawing | Circuit drawing | |
|--|------------------|------------------|----------|------------------|-----------|-------------------------|--------------------|------------------|---------------------|-------------------|-----------------|-------|
| Illuminated pushbutton actuator, flush mounting | IP 40 | SA | 1 NC | MA | S | 18-288.035 | 18-268.035 | 2 | 2 | 4 | 2 | 0.002 |
| | | | | M | S | 18-188.035 | 18-168.035 | 2 | 2 | 4 | 4 | 0.002 |
| | | | 1 NO | MA | S | 18-287.035 | 18-267.035 | 2 | 2 | 4 | 3 | 0.002 |
| | | | | M | S | 18-187.035 | 18-167.035 | 2 | 2 | 4 | 5 | 0.002 |

Switching system: SA = Snap-action switching element

Contacts: NC = Normally closed, NO = Normally open

Switching action: MA = Maintained action, M = Momentary action

Terminals: S = Soldering terminal

Component layout from page 11, Mounting dimensions from page 12, Technical drawing from page 12, Circuit drawing from page 13

Front

Lens without LED

| | Lens | ∅ 9 x 9 mm Typ-Nr. | ∅ 9 x 14 mm Typ-Nr. | ∅ 9 mm Typ-Nr. |  |
|---|----------------------------------|-----------------------|------------------------|-------------------|---|
| Lens without LED illuminative | Plastic green translucent flush | 18-952.5 | 18-942.5 | 18-932.5 | 0.001 |
| | Plastic red translucent flush | 18-952.2 | 18-942.2 | 18-932.2 | 0.001 |
| | Plastic white translucent flush | 18-952.9 | 18-942.9 | 18-932.9 | 0.001 |
| | Plastic yellow translucent flush | 18-952.4 | 18-942.4 | 18-932.4 | 0.001 |
| non-illuminative | Plastic black opaque flush | 18-952.0 | 18-942.0 | 18-932.0 | 0.001 |
| | Plastic grey opaque flush | 18-952.8 | 18-942.8 | 18-932.8 | 0.001 |



Lens with LED

| | Lens | ∅ 9 x 9 mm Typ-Nr. | ∅ 9 x 14 mm Typ-Nr. | ∅ 9 mm Typ-Nr. |  |
|--|----------------------------------|-----------------------|------------------------|-------------------|---|
| Lens with LED without built-in series resistor, typ. forward voltage 2.2 VDC, 20 mA | Plastic green translucent flush | 18-951.5 | 18-941.5 | 18-931.5 | 0.001 |
| | Plastic red translucent flush | 18-951.2 | 18-941.2 | 18-931.2 | 0.001 |
| | Plastic yellow translucent flush | 18-951.4 | 18-941.4 | 18-931.4 | 0.001 |



Lens without LED, flush mounting

| | Lens | ∅ 19 x 19 mm Typ-Nr. | ∅ 19 mm Typ-Nr. |  |
|---|----------------------------------|-------------------------|--------------------|---|
| Lens without LED, flush mounting illuminative | Plastic green translucent flush | 18-982.5 | 18-962.5 | 0.001 |
| | Plastic red translucent flush | 18-982.2 | 18-962.2 | 0.001 |
| | Plastic white translucent flush | 18-982.9 | 18-962.9 | 0.001 |
| | Plastic yellow translucent flush | 18-982.4 | 18-962.4 | 0.001 |
| non-illuminative | Plastic black opaque flush | 18-982.0 | 18-962.0 | 0.001 |
| | Plastic grey opaque flush | 18-982.8 | 18-962.8 | 0.001 |



Lens with LED, flush mounting

| | Lens | ∅ 19 x 19 mm Typ-Nr. | ∅ 19 mm Typ-Nr. |  |
|--|----------------------------------|-------------------------|--------------------|---|
| Lens with LED, flush mounting without built-in series resistor, typ. forward voltage 2.2 VDC, 20 mA | Plastic green translucent flush | 18-981.5 | 18-961.5 | 0.001 |
| | Plastic red translucent flush | 18-981.2 | 18-961.2 | 0.001 |
| | Plastic yellow translucent flush | 18-981.4 | 18-961.4 | 0.001 |



Front bezel set, flush mounting

| | Front bezel | Ø 19 x 19 mm Typ-Nr. | Ø 19 mm Typ-Nr. | Mounting dimensions | |
|--|---------------|-------------------------|--------------------|---------------------|-------|
| Front bezel set, flush mounting for Lens round | Plastic black | 18-920.2 | 18-920.3 | 2 | 0.006 |
| for Lens square | Plastic black | 18-920.1 | | 2 | 0.006 |



Mounting dimensions from page 12

Blind plug

| | | Ø 9 x 9 mm Typ-Nr. | Ø 9 mm Typ-Nr. | Mounting dimensions | |
|-------------------|--|-----------------------|-------------------|---------------------|-------|
| Blind plug | | 19-948.0 | 19-949.0 | 3 | 0.001 |



Mounting dimensions from page 12

Backside

PCB plug-in base

| | Terminals | Typ-Nr. | Component layout | Technical drawing | |
|---------------------------------------|-----------|---------------|------------------|-------------------|-------|
| PCB plug-in base Pins axial | P | 18-945 | 3 | 5 | 0.001 |
| Pins bent at right-angles | P | 18-946 | 4 | 6 | 0.001 |



Terminals: P = PCB terminal

Component layout from page 11, Technical drawing from page 12

Assembling

Lens remover

| | Typ-Nr. | |
|---------------------|---------------|-------|
| Lens remover | 18-910 | 0.002 |



Mounting tool

| | Typ-Nr. |  |
|--|---------------|---|
| Mounting tool for Fixing nut long 19-991 | 19-905 | 0.011 |



Actuator with snap-action switching element

Switching system

The snap-action switching system was designed for switching low powers in electronic circuits.
Single-break snap-action contact.

Material

Lens

Polymethylacrylate (PMMA), Polycarbonate (PC)

Material of contact

Gold contact on nickel plating

Actuator housing

Polyamide, colour black

Mechanical characteristics

Terminals

The terminals can be used as soldering terminals.
Max.wire diameter: 2 x 0.5 mm²
Max.wire ccross-section of stranded cable 1 x 0.75 mm²
Wire cross-section of terminal 1.6 x 0.4 mm

Tightening torque

for fixing nut max. 20 Ncm

Actuating force

1.4 N

Actuating travel

2.2 mm ±0.2 mm

Rebound time

≤2.5 ms

Mechanical lifetime

Momentary action 2 million cycles of operation
Maintained action 1 million cycles of operation,
as per IEC 60512-5-9a

Electrical characteristics

Contact resistance

≤100 mΩ starting value (initial), as per IEC 60512-2-2b

Electrical life

≥500 000 cycles of operation at 30 VDC, 100 mA, as per IEC 60512-5-9c

Power consumption LED

20 mA

Switch rating

min. 10 μA at 100 μV
max. 100 mA at 42 VAC/VDC

Electric strength

500 VAC, 50 Hz, 1 min. between all terminals and earth, as per IEC 60512-2-11

Environmental conditions

Storage temperature

-40 °C ... +80 °C

Service temperature

-25 °C ... +65 °C

Protection degree

IP 40 front side, as per IEC 60529

Shock resistance

(Single impacts, semi-sinusoidal)
50 g for 11 ms, as per IEC 60068-2-27

Vibration resistance

(sinusoidal)10 g at 10-2000 Hz, amplitude 0.75 mm, as per IEC 60512-4-4

Approvals

Declaration of conformity

RoHS

Component layout

1 Indicator page 5

9 x 9 mm

9 x 14 mm

Ø9 mm



2 Illuminated pushbutton actuator page 5 | Indicator actuator, flush mounting page 6 | Illuminated pushbutton actuator, flush mounting page 6

9 x 9 mm

9 x 14 mm

Ø9 mm



X contact-nr.
2 = NO
4 = NC

3 PCB plug-in base page 8

Drilling plan (element side)
Through-connection recommended



4 PCB plug-in base page 8

Drilling plan (element side)
Through-connection recommended



Mounting dimensions

1 Indicator page 5 | Illuminated pushbutton actuator page 5



2 Indicator actuator, flush mounting page 6 | Illuminated pushbutton actuator, flush mounting page 6 | Front bezel set, flush mounting page 8



3 Blind plug page 8



Technical drawing

1 Indicator page 5



2 Illuminated pushbutton actuator page 5

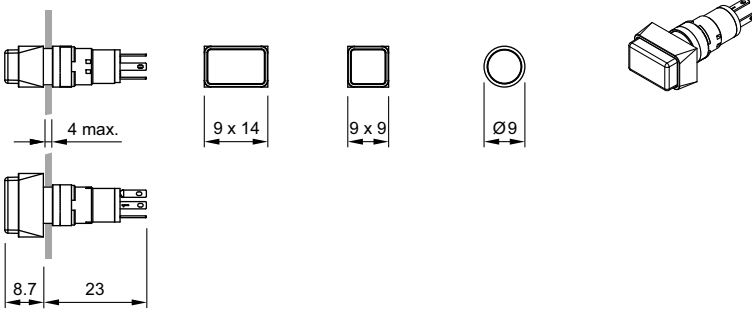

3 Indicator actuator, flush mounting page 6



4 Illuminated pushbutton actuator, flush mounting page 6



5 PCB plug-in base page 8



6 PCB plug-in base page 8



Circuit drawing

1 Indicator page 5 | Indicator actuator, flush mounting page 6



2 Illuminated pushbutton actuator page 5 | **Illuminated pushbutton actuator, flush mounting** page 6



3 Illuminated pushbutton actuator page 5 | **Illuminated pushbutton actuator, flush mounting** page 6



4 Illuminated pushbutton actuator page 5 | **Illuminated pushbutton actuator, flush mounting** page 6



5 Illuminated pushbutton actuator page 5 | **Illuminated pushbutton actuator, flush mounting** page 6



Index from Typ-Nr.

| Typ-Nr. | Page | Typ-Nr. | Page | Typ-Nr. | Page |
|-------------|------|------------|------|---------|------|
| 18-030.0052 | 5 | 18-287.035 | 6 | | |
| 18-030.0054 | 5 | 18-288.035 | 6 | | |
| 18-030.0055 | 5 | 18-910 | 8 | | |
| 18-031.0052 | 5 | 18-920.1 | 8 | | |
| 18-031.0054 | 5 | 18-920.2 | 8 | | |
| 18-031.0055 | 5 | 18-920.3 | 8 | | |
| 18-032.0052 | 5 | 18-931.2 | 7 | | |
| 18-032.0054 | 5 | 18-931.4 | 7 | | |
| 18-032.0055 | 5 | 18-931.5 | 7 | | |
| 18-040.0052 | 5 | 18-932.0 | 7 | | |
| 18-040.0054 | 5 | 18-932.2 | 7 | | |
| 18-040.0055 | 5 | 18-932.4 | 7 | | |
| 18-041.0052 | 5 | 18-932.5 | 7 | | |
| 18-041.0054 | 5 | 18-932.8 | 7 | | |
| 18-041.0055 | 5 | 18-932.9 | 7 | | |
| 18-042.0052 | 5 | 18-941.2 | 7 | | |
| 18-042.0054 | 5 | 18-941.4 | 7 | | |
| 18-042.0055 | 5 | 18-941.5 | 7 | | |
| 18-050.0052 | 5 | 18-942.0 | 7 | | |
| 18-050.0054 | 5 | 18-942.2 | 7 | | |
| 18-050.0055 | 5 | 18-942.4 | 7 | | |
| 18-051.0052 | 5 | 18-942.5 | 7 | | |
| 18-051.0054 | 5 | 18-942.8 | 7 | | |
| 18-051.0055 | 5 | 18-942.9 | 7 | | |
| 18-052.0052 | 5 | 18-945 | 8 | | |
| 18-052.0054 | 5 | 18-946 | 8 | | |
| 18-052.0055 | 5 | 18-951.2 | 7 | | |
| 18-060.0052 | 6 | 18-951.4 | 7 | | |
| 18-060.0054 | 6 | 18-951.5 | 7 | | |
| 18-060.0055 | 6 | 18-952.0 | 7 | | |
| 18-061.0052 | 6 | 18-952.2 | 7 | | |
| 18-061.0054 | 6 | 18-952.4 | 7 | | |
| 18-061.0055 | 6 | 18-952.5 | 7 | | |
| 18-062.0052 | 6 | 18-952.8 | 7 | | |
| 18-062.0054 | 6 | 18-952.9 | 7 | | |
| 18-062.0055 | 6 | 18-961.2 | 7 | | |
| 18-080.0052 | 6 | 18-961.4 | 7 | | |
| 18-080.0054 | 6 | 18-961.5 | 7 | | |
| 18-080.0055 | 6 | 18-962.0 | 7 | | |
| 18-081.0052 | 6 | 18-962.2 | 7 | | |
| 18-081.0054 | 6 | 18-962.4 | 7 | | |
| 18-081.0055 | 6 | 18-962.5 | 7 | | |
| 18-082.0052 | 6 | 18-962.8 | 7 | | |
| 18-082.0054 | 6 | 18-962.9 | 7 | | |
| 18-082.0055 | 6 | 18-981.2 | 7 | | |
| 18-137.035 | 5 | 18-981.4 | 7 | | |
| 18-138.035 | 5 | 18-981.5 | 7 | | |
| 18-147.035 | 5 | 18-982.0 | 7 | | |
| 18-148.035 | 5 | 18-982.2 | 7 | | |
| 18-157.035 | 5 | 18-982.4 | 7 | | |
| 18-158.035 | 5 | 18-982.5 | 7 | | |
| 18-167.035 | 6 | 18-982.8 | 7 | | |
| 18-168.035 | 6 | 18-982.9 | 7 | | |
| 18-187.035 | 6 | 19-905 | 9 | | |
| 18-188.035 | 6 | 19-948.0 | 8 | | |
| 18-237.035 | 5 | 19-949.0 | 8 | | |
| 18-238.035 | 5 | | | | |
| 18-247.035 | 5 | | | | |
| 18-248.035 | 5 | | | | |
| 18-257.035 | 5 | | | | |
| 18-258.035 | 5 | | | | |
| 18-267.035 | 6 | | | | |
| 18-268.035 | 6 | | | | |

| | |
|----------------|---|
| | EAO AG |
| | Tannwaldstrasse 88 4601 Olten, Switzerland |
| E-mail | info@eao.com |
| Website | www.eao.com |
| | Austria |
| Phone | +49 201 85 87 0 |
| Fax | +49 201 85 87 210 |
| E-mail | sales.ede@eao.com |
| | Belgium |
| Phone | +32 3 777 82 36 |
| Fax | +32 3 777 84 19 |
| E-mail | sales.ebl@eao.com |
| | China |
| Phone | +852 27 86 91 41 |
| Fax | +852 27 86 95 61 |
| E-mail | sales.ehk@eao.com |
| | France |
| Phone | +33 1 64 43 37 37 |
| Fax | +33 1 64 43 37 49 |
| E-mail | sales.esa@eao.com |
| | Germany |
| Phone | +49 201 85 87 0 |
| Fax | +49 201 85 87 210 |
| E-mail | sales.ede@eao.com |
| | Italy |
| Phone | +39 035 481 0189 |
| Fax | +39 035 481 3786 |
| E-mail | sales.eit@eao.com |
| | Japan |
| Phone | +81 3 5444 5411 |
| Fax | +81 3 5444 0345 |
| E-mail | sales.esj@eao.com |
| | Netherlands |
| Phone | +31 78 653 17 00 |
| Fax | +31 78 653 17 99 |
| E-mail | sales.enl@eao.com |
| | Sweden |
| Phone | +46 8 683 86 60 |
| Fax | +46 8 724 29 12 |
| E-mail | sales.esw@eao.com |
| | Switzerland |
| Phone | +41 62 388 95 00 |
| Fax | +41 62 388 95 55 |
| E-mail | sales.ech@eao.com |
| | United Kingdom |
| Phone | +44 1444 236 000 |
| Fax | +44 1444 236 641 |
| E-mail | sales.euk@eao.com |
| | USA |
| Phone | +1 203 877 4577 |
| Fax | +1 203 877 3694 |
| E-mail | sales.eus@eao.com |
| | Other Countries |
| Phone | +41 62 286 92 10 |
| Fax | +41 62 296 21 62 |
| E-mail | info@eao.com |

Компания «Life Electronics» занимается поставками электронных компонентов импортного и отечественного производства от производителей и со складов крупных дистрибьюторов Европы, Америки и Азии.

С конца 2013 года компания активно расширяет линейку поставок компонентов по направлению коаксиальный кабель, кварцевые генераторы и конденсаторы (керамические, пленочные, электролитические), за счёт заключения дистрибьюторских договоров

Мы предлагаем:

- Конкурентоспособные цены и скидки постоянным клиентам.
- Специальные условия для постоянных клиентов.
- Подбор аналогов.
- Поставку компонентов в любых объемах, удовлетворяющих вашим потребностям.
- Приемлемые сроки поставки, возможна ускоренная поставка.
- Доставку товара в любую точку России и стран СНГ.
- Комплексную поставку.
- Работу по проектам и поставку образцов.
- Формирование склада под заказчика.
- Сертификаты соответствия на поставляемую продукцию (по желанию клиента).
- Тестирование поставляемой продукции.
- Поставку компонентов, требующих военную и космическую приемку.
- Входной контроль качества.
- Наличие сертификата ISO.

В составе нашей компании организован Конструкторский отдел, призванный помогать разработчикам, и инженерам.

Конструкторский отдел помогает осуществить:

- Регистрацию проекта у производителя компонентов.
- Техническую поддержку проекта.
- Защиту от снятия компонента с производства.
- Оценку стоимости проекта по компонентам.
- Изготовление тестовой платы монтаж и пусконаладочные работы.



Тел: +7 (812) 336 43 04 (многоканальный)

Email: org@lifeelectronics.ru