

## FEATURES

- 12 MHz multiplying bandwidth
- INL of  $\pm 0.5$  LSB at 12 bits
- Pin-compatible 12-/14-bit current output DAC
- 2.5 V to 5.5 V supply operation
- 10-lead MSOP package
- $\pm 10$  V reference input
- 50 MHz serial interface
- 2.7 MSPS update rate
- Extended temperature range:  $-40^{\circ}\text{C}$  to  $+125^{\circ}\text{C}$
- 4-quadrant multiplication
- Power-on reset with brownout detection
- 0.4  $\mu\text{A}$  typical current consumption
- Guaranteed monotonic

## APPLICATIONS

- Portable, battery-powered applications
- Waveform generators
- Analog processing
- Instrumentation applications
- Programmable amplifiers and attenuators
- Digitally controlled calibration
- Programmable filters and oscillators
- Composite video
- Ultrasound
- Gain, offset, and voltage trimming
- Automotive radar

## GENERAL DESCRIPTION

The AD5444/AD5446<sup>1</sup> are CMOS 12-bit and 14-bit, current output, digital-to-analog converters (DACs). Operating from a single 2.5 V to 5.5 V power supply, these devices are suited for battery-powered and other applications.

As a result of the CMOS submicron manufacturing process, these parts offer excellent 4-quadrant multiplication characteristics of up to 12 MHz.

These DACs use a double-buffered, 3-wire serial interface that is compatible with SPI®, QSPI™, MICROWIRE™, and most DSP interface standards. On power-up, the internal shift register and latches are filled with 0s, and the DAC output is at zero scale.

The applied external reference input voltage ( $V_{\text{REF}}$ ) determines the full-scale output current. These parts can handle  $\pm 10$  V inputs on the reference, despite operating from a single-supply power supply of 2.5 V to 5.5 V. An integrated feedback resistor ( $R_{\text{FB}}$ ) provides temperature tracking and full-scale voltage output when combined with an external current-to-voltage precision amplifier. The AD5444/AD5446 DACs are available in small 10-lead MSOP packages, which are pin-compatible with the [AD5425/AD5426/AD5432/AD5443](#) family of DACs.

The [EVAL-AD5446SDZ](#) board is available for evaluating DAC performance. For more information, see the [UG-327](#) evaluation board user guide.

<sup>1</sup> US Patent Number 5,689,257.

## FUNCTIONAL BLOCK DIAGRAM

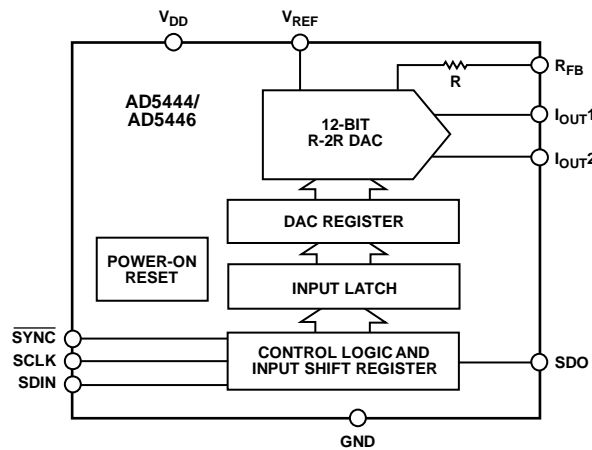

Figure 1.

## Rev. D

Information furnished by Analog Devices is believed to be accurate and reliable. However, no responsibility is assumed by Analog Devices for its use, nor for any infringements of patents or other rights of third parties that may result from its use. Specifications subject to change without notice. No license is granted by implication or otherwise under any patent or patent rights of Analog Devices. Trademarks and registered trademarks are the property of their respective owners.

## TABLE OF CONTENTS

Features .....	1	DAC Section.....	15
Applications.....	1	Circuit Operation .....	15
General Description .....	1	Single-Supply Applications .....	17
Functional Block Diagram .....	1	Adding Gain.....	17
Revision History .....	2	Divider or Programmable Gain Element.....	17
Specifications.....	3	Amplifier Selection .....	18
Timing Characteristics .....	5	Reference Selection .....	18
Absolute Maximum Ratings.....	6	Serial Interface .....	20
ESD Caution.....	6	Microprocessor Interfacing.....	21
Pin Configuration and Function Descriptions.....	7	PCB Layout and Power Supply Decoupling.....	23
Typical Performance Characteristics .....	8	Overview of AD54xx and AD55xx Current Output Devices...	24
Terminology .....	14	Outline Dimensions .....	25
General Description .....	15	Ordering Guide .....	25

## REVISION HISTORY

### 4/12—Rev. C to Rev. D

Changes to General Description Section .....	1
Deleted Evaluation Board for the DAC Section .....	23
Deleted Power Supplies for the Evaluation Board Section .....	23
Deleted Figure 54; Renumbered Sequentially.....	24
Deleted Figure 55 and Figure 56.....	25
Updated Outline Dimensions .....	25
Changes to Ordering Guide .....	25
Deleted Figure 57.....	26

### 4/07—Rev. B to Rev. C

Changes to Table 9.....	19
Changes to Ordering Guide .....	28
Changes to Features.....	1
Changes to General Description .....	1
Changes to Table 1.....	3
Changes to Figure 22.....	10
Changes to Figure 23.....	10
Changes to Table 9.....	19
Changes to Table 12.....	27
Updated Outline Dimensions .....	28
Changes to Ordering Guide .....	28

### 4/05—Rev. 0 to Rev. A

Added AD5446.....	Universal
Changes to Features .....	1
Changes to General Description .....	1
Changes to Specifications.....	3
Inserted Figure 7; Renumbered Sequentially.....	9
Inserted Figure 9; Renumbered Sequentially.....	9
Inserted Figure 13; Renumbered Sequentially .....	10
Changes to Figure 22.....	11
Changes to Figure 23.....	11
Changes to Serial Interface.....	20
Changes to Figure 44.....	20
Changes to Figure 45.....	20
Updated Outline Dimensions .....	28
Changes to Ordering Guide .....	28

### 10/04—Revision 0: Initial Version

## SPECIFICATIONS

$V_{DD} = 2.5\text{ V to }5.5\text{ V}$ ,  $V_{REF} = 10\text{ V}$ ,  $I_{OUT2} = 0\text{ V}$ . Temperature range for Y version:  $-40^{\circ}\text{C to }+125^{\circ}\text{C}$ . All specifications  $T_{MIN}$  to  $T_{MAX}$ , unless otherwise noted. DC performance measured with OP177, and ac performance measured with AD8038, unless otherwise noted.

Table 1.

Parameter	Min	Typ	Max	Unit	Conditions
STATIC PERFORMANCE					
AD5444					
Resolution			12	Bits	Guaranteed monotonic
Relative Accuracy			$\pm 0.5$	LSB	
Differential Nonlinearity			$\pm 1$	LSB	
Total Unadjusted Error (TUE)			$\pm 1$	LSB	
Gain Error			$\pm 0.5$	LSB	
AD5446					
Resolution			14	Bits	Guaranteed monotonic
Relative Accuracy			$\pm 2$	LSB	
Differential Nonlinearity			$-1/+2$	LSB	
Total Unadjusted Error (TUE)			$\pm 4$	LSB	
Gain Error			$\pm 2.5$	LSB	
Gain Error Temperature Coefficient <sup>1</sup>		$\pm 2$		ppm FSR/ $^{\circ}\text{C}$	
Output Leakage Current			$\pm 1$	nA	Data = 0x0000, $T_A = 25^{\circ}\text{C}$ , $I_{OUT1}$
			$\pm 10$	nA	Data = 0x0000, $T_A = -40^{\circ}\text{C to }+125^{\circ}\text{C}$ , $I_{OUT1}$
REFERENCE INPUT <sup>1</sup>					
Reference Input Range		$\pm 10$		V	
$V_{REF}$ Input Resistance	7	9	11	k $\Omega$	Input resistance $T_C = -50\text{ ppm}/^{\circ}\text{C}$
$R_{FB}$ Feedback Resistance	7	9	11	k $\Omega$	Input resistance $T_C = -50\text{ ppm}/^{\circ}\text{C}$
Input Capacitance					
Zero-Scale Code		18	22	pF	
Full-Scale Code		18	22	pF	
DIGITAL INPUTS/OUTPUTS <sup>1</sup>					
Input High Voltage, $V_{IH}$	2.0			V	$V_{DD} = 3.6\text{ V to }5\text{ V}$
	1.7			V	$V_{DD} = 2.5\text{ V to }3.6\text{ V}$
Input Low Voltage, $V_{IL}$			0.8	V	$V_{DD} = 2.7\text{ V to }5.5\text{ V}$
			0.7	V	$V_{DD} = 2.5\text{ V to }2.7\text{ V}$
Output High Voltage, $V_{OH}$	$V_{DD} - 1$			V	$V_{DD} = 4.5\text{ V to }5\text{ V}$ , $I_{SOURCE} = 200\text{ }\mu\text{A}$
	$V_{DD} - 0.5$			V	$V_{DD} = 2.5\text{ V to }3.6\text{ V}$ , $I_{SOURCE} = 200\text{ }\mu\text{A}$
Output Low Voltage, $V_{OL}$			0.4	V	$V_{DD} = 4.5\text{ V to }5\text{ V}$ , $I_{SINK} = 200\text{ }\mu\text{A}$
			0.4	V	$V_{DD} = 2.5\text{ V to }3.6\text{ V}$ , $I_{SINK} = 200\text{ }\mu\text{A}$
Input Leakage Current, $I_{IL}$			$\pm 1$	nA	$T_A = 25^{\circ}\text{C}$
			$\pm 10$	nA	$T_A = -40^{\circ}\text{C to }+125^{\circ}\text{C}$
Input Capacitance			10	pF	

Parameter	Min	Typ	Max	Unit	Conditions
<b>DYNAMIC PERFORMANCE<sup>1</sup></b>					
Reference Multiplying Bandwidth		12		MHz	$V_{REF} = \pm 3.5\text{ V}$ , DAC loaded with all 1s
Multiplying Feedthrough Error			72	dB	$V_{REF} = \pm 3.5\text{ V}$ , DAC loaded with all 0s
			64	dB	100 kHz
			44	dB	1 MHz
					10 MHz
Output Voltage Settling Time					$V_{REF} = 10\text{ V}$ , $R_{LOAD} = 100\ \Omega$ , DAC latch alternately loaded with 0s and 1s
Measured to $\pm 1\text{ mV}$ of FS		100	110	ns	
Measured to $\pm 4\text{ mV}$ of FS		24	40	ns	
Measured to $\pm 16\text{ mV}$ of FS		16	33	ns	
Digital Delay		20	40	ns	Interface delay time
10%-to-90% Settling Time		10	30	ns	Rise and fall time, $V_{REF} = 10\text{ V}$ , $R_{LOAD} = 100\ \Omega$
Digital-to-Analog Glitch Impulse		2		nV-s	1 LSB change around major carry, $V_{REF} = 0\text{ V}$
Output Capacitance					
$I_{OUT1}$		13		pF	DAC latches loaded with all 0s
		28		pF	DAC latches loaded with all 1s
$I_{OUT2}$		18		pF	DAC latches loaded with all 0s
		5		pF	DAC latches loaded with all 1s
Digital Feedthrough		0.5		nV-s	Feedthrough to DAC output with $\overline{CS}$ high and alternate loading of all 0s and all 1s
Analog THD		83		dB	$V_{REF} = 3.5\text{ V}$ p-p, all 1s loaded, $f = 1\text{ kHz}$
Digital THD					Clock = 1 MHz, $V_{REF} = 3.5\text{ V}$
50 kHz $f_{OUT}$		71		dB	
20 kHz $f_{OUT}$		77		dB	
Output Noise Spectral Density		25		nV/ $\sqrt{\text{Hz}}$	@ 1 kHz
SFDR Performance (Wide Band)					Clock = 10 MHz, $V_{REF} = 3.5\text{ V}$
50 kHz $f_{OUT}$		78		dB	
20 kHz $f_{OUT}$		74		dB	
SFDR Performance (Narrow Band)					Clock = 1 MHz, $V_{REF} = 3.5\text{ V}$
50 kHz $f_{OUT}$		87		dB	
20 kHz $f_{OUT}$		85		dB	
Intermodulation Distortion		79		dB	$f_1 = 20\text{ kHz}$ , $f_2 = 25\text{ kHz}$ , clock = 1 MHz, $V_{REF} = 3.5\text{ V}$
<b>POWER REQUIREMENTS</b>					
Power Supply Range, $V_{DD}$	2.5		5.5	V	
Supply Current, $I_{DD}$		0.4	10	$\mu\text{A}$	$T_A = -40^\circ\text{C}$ to $+125^\circ\text{C}$ , logic inputs = 0 V or $V_{DD}$
			0.6	$\mu\text{A}$	$T_A = 25^\circ\text{C}$ , logic inputs = 0 V or $V_{DD}$
Power Supply Sensitivity <sup>1</sup>			0.001	%/%	$\Delta V_{DD} = \pm 5\%$

<sup>1</sup> Guaranteed by design and characterization; not subject to production test.

**TIMING CHARACTERISTICS**

All input signals are specified with  $t_r = t_f = 1 \text{ ns}$  (10% to 90% of  $V_{DD}$ ) and timed from a voltage level of  $(V_{IL} + V_{IH})/2$ .  $V_{DD} = 2.5 \text{ V to } 5.5 \text{ V}$ ,  $V_{REF} = 10 \text{ V}$ ,  $I_{OUT2} = 0 \text{ V}$ , temperature range for Y version:  $-40^\circ\text{C to } +125^\circ\text{C}$ ; all specifications  $T_{MIN}$  to  $T_{MAX}$ , unless otherwise noted.

Table 2.

Parameter <sup>1</sup>	$V_{DD} = 4.5 \text{ V to } 5.5 \text{ V}$	$V_{DD} = 2.5 \text{ V to } 5.5 \text{ V}$	Unit	Conditions/Comments
$f_{SCLK}$	50	50	MHz max	Maximum clock frequency.
$t_1$	20	20	ns min	SCLK cycle time.
$t_2$	8	8	ns min	SCLK high time.
$t_3$	8	8	ns min	SCLK low time.
$t_4$	8	8	ns min	$\overline{SYNC}$ falling edge to SCLK active edge setup time.
$t_5$	5	5	ns min	Data setup time.
$t_6$	4.5	4.5	ns min	Data hold time.
$t_7$	5	5	ns min	$\overline{SYNC}$ rising edge to SCLK active edge setup time
$t_8$	30	30	ns min	Minimum $\overline{SYNC}$ high time.
$t_9$	23	30	ns min	SCLK active edge to SDO valid.
Update Rate	2.7	2.7	MSPS	Consists of cycle time, $\overline{SYNC}$ high time, data setup time and output voltage settling time.

<sup>1</sup> Guaranteed by design and characterization; not subject to production test.

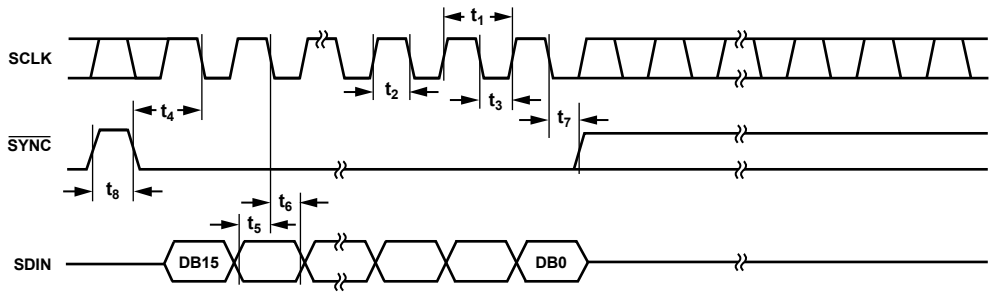
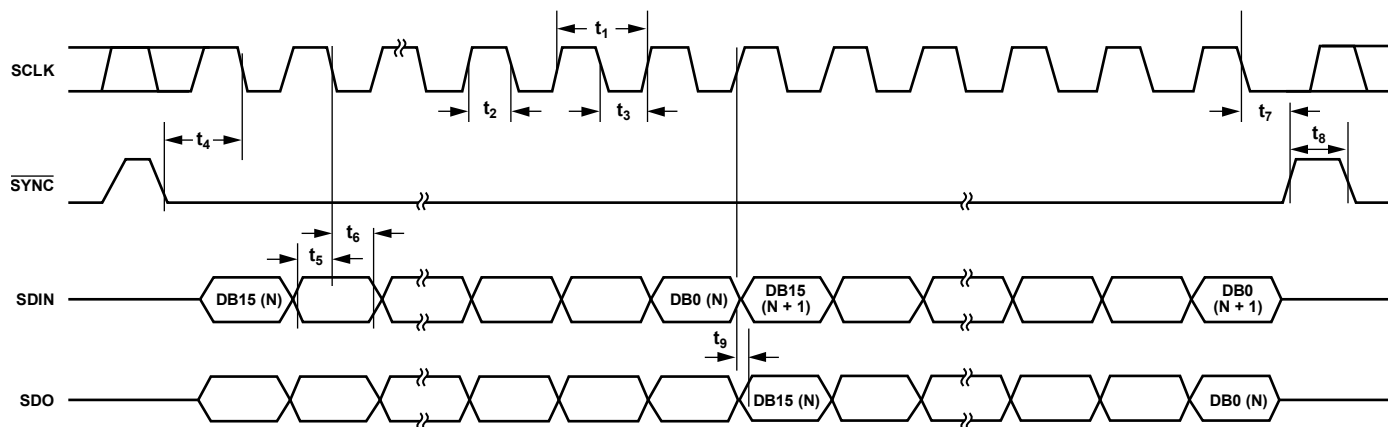

Figure 2. Standalone Timing Diagram

04588-002



NOTES  
 ALTERNATIVELY, DATA CAN BE CLOCKED INTO INPUT SHIFT REGISTER ON RISING EDGE OF SCLK AS DETERMINED BY CONTROL BITS. IN THIS CASE, DATA IS CLOCKED OUT OF SDO ON FALLING EDGE OF SCLK. TIMING AS ABOVE, WITH SCLK INVERTED.

Figure 3. Daisy-Chain Timing Diagram

04588-003

## ABSOLUTE MAXIMUM RATINGS

$T_A = 25^\circ\text{C}$ , unless otherwise noted. Transient currents of up to 100 mA do not cause SCR latch-up.

**Table 3.**

Parameter	Rating
$V_{DD}$ to GND	-0.3 V to +7 V
$V_{REF}$ , $R_{FB}$ to GND	-12 V to +12 V
$I_{OUT1}$ , $I_{OUT2}$ to GND	-0.3 V to +7 V
Logic Inputs and Outputs <sup>1</sup>	-0.3 V to $V_{DD} + 0.3$ V
Input Current (All Pins Except Supplies)	$\pm 10$ mA
Operating Temperature Range	-40°C to +125°C
Extended (Y Version)	
Storage Temperature Range	-65°C to +150°C
Junction Temperature	150°C
10-lead MSOP $\theta_{JA}$ Thermal Impedance	206°C/W
Lead Temperature, Soldering (10 sec)	300°C
IR Reflow, Peak Temperature (<20 sec)	235°C

<sup>1</sup> Overvoltages at SCLK,  $\overline{\text{SYNC}}$ , and SDIN are clamped by internal diodes.

Stresses above those listed under Absolute Maximum Ratings may cause permanent damage to the device. This is a stress rating only; functional operation of the device at these or any other conditions above those indicated in the operational section of this specification is not implied. Exposure to absolute maximum rating conditions for extended periods may affect device reliability.

Only one absolute maximum rating can be applied at any one time.

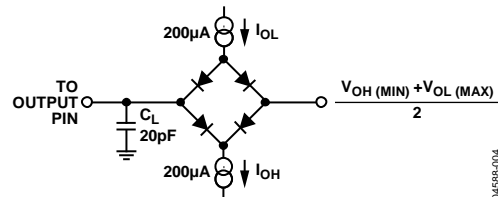

Figure 4. Load Circuit for SDO Timing Specifications

## ESD CAUTION



**ESD (electrostatic discharge) sensitive device.** Charged devices and circuit boards can discharge without detection. Although this product features patented or proprietary protection circuitry, damage may occur on devices subjected to high energy ESD. Therefore, proper ESD precautions should be taken to avoid performance degradation or loss of functionality.

## PIN CONFIGURATION AND FUNCTION DESCRIPTIONS

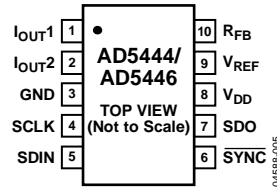

Figure 5. Pin Configuration

Table 4. Pin Function Descriptions

Pin No.	Mnemonic	Description
1	$I_{OUT1}$	DAC Current Output.
2	$I_{OUT2}$	DAC Analog Ground. This pin should normally be tied to the analog ground of the system.
3	GND	Ground Pin.
4	SCLK	Serial Clock Input. By default, data is clocked into the input shift register on the falling edge of the serial clock input. Alternatively, by means of the serial control bits, the device can be configured such that data is clocked into the shift register on the rising edge of SCLK.
5	SDIN	Serial Data Input. Data is clocked into the 16-bit input register on the active edge of the serial clock input. By default on power-up, data is clocked into the shift register on the falling edge of SCLK. The control bits allow the user to change the active edge to the rising edge.
6	$\overline{\text{SYNC}}$	Active Low Control Input. This is the frame synchronization signal for the input data. When $\overline{\text{SYNC}}$ is taken low, data is loaded to the shift register on the active edge of the following clocks. The output updates on the rising edge of $\overline{\text{SYNC}}$ .
7	SDO	Serial Data Output. This pin allows a number of parts to be daisy-chained. By default, data is clocked into the shift register on the falling edge and out via SDO on the rising edge of SCLK. Data is always clocked out on the alternate edge to data loaded to the shift register.
8	$V_{DD}$	Positive Power Supply Input. This part can be operated from a supply of 2.5 V to 5.5 V.
9	$V_{REF}$	DAC Reference Voltage Input.
10	$R_{FB}$	DAC Feedback Resistor. Establishes voltage output for the DAC by connecting to an external amplifier output.

TYPICAL PERFORMANCE CHARACTERISTICS

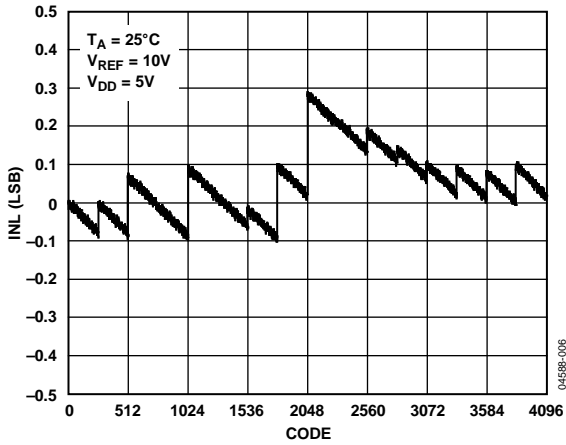

Figure 6. INL vs. Code (12-Bit DAC)

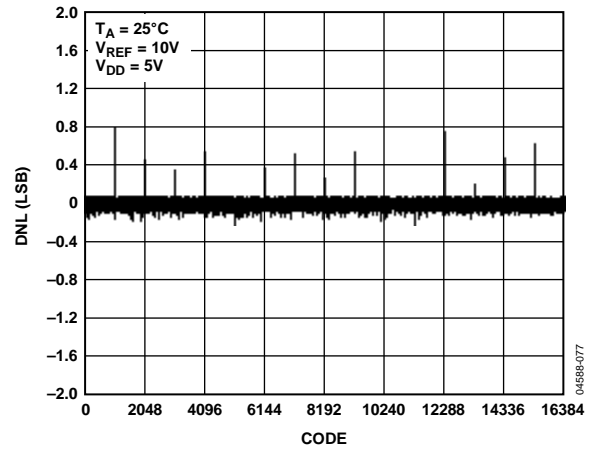

Figure 9. DNL vs. Code (14-Bit DAC)

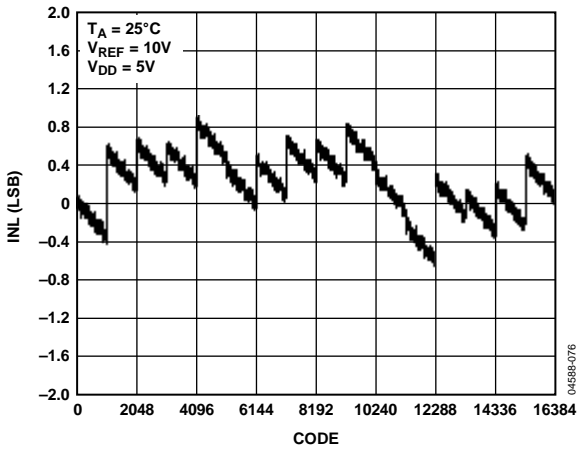

Figure 7. INL vs. Code (14-Bit DAC)

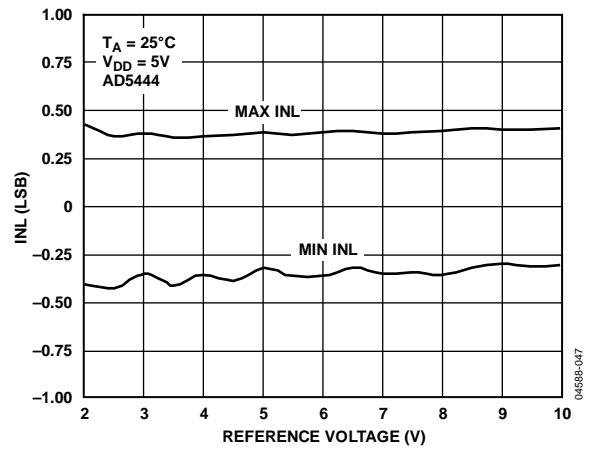

Figure 10. INL vs. Reference Voltage

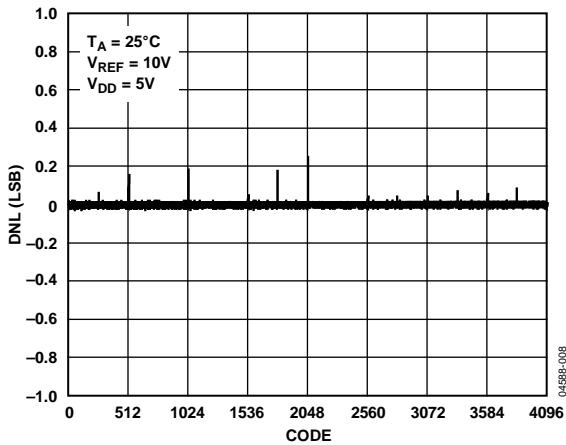

Figure 8. DNL vs. Code (12-Bit DAC)

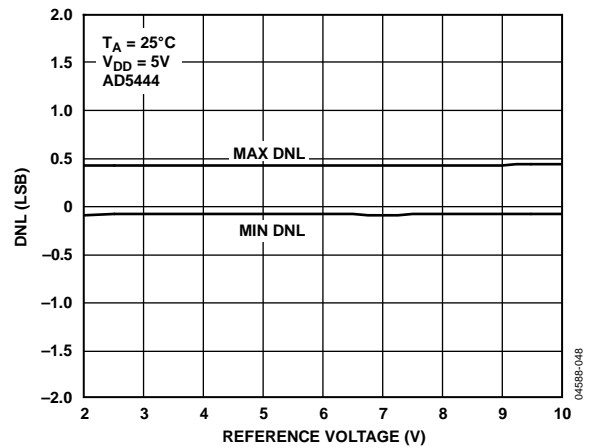

Figure 11. DNL vs. Reference Voltage



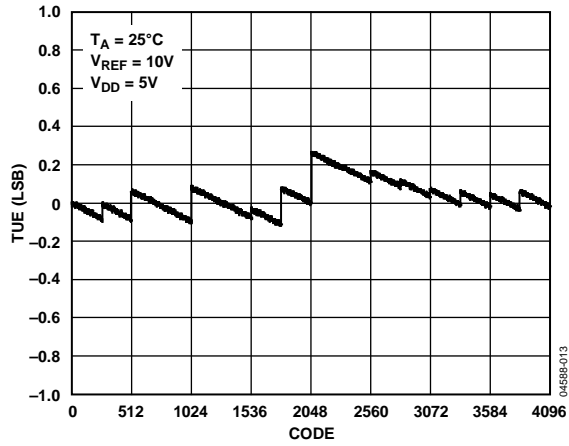

Figure 12. TUE vs. Code (12-Bit DAC)

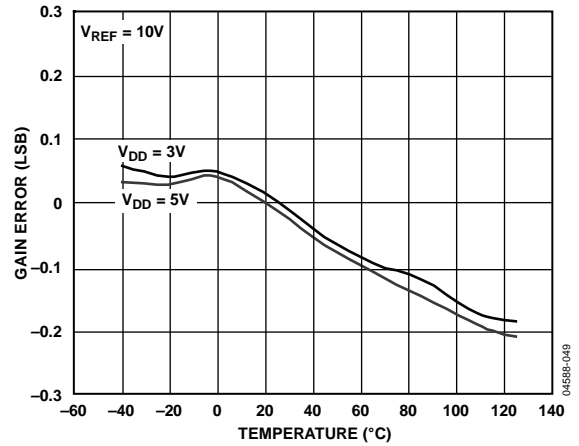

Figure 15. Gain Error vs. Temperature

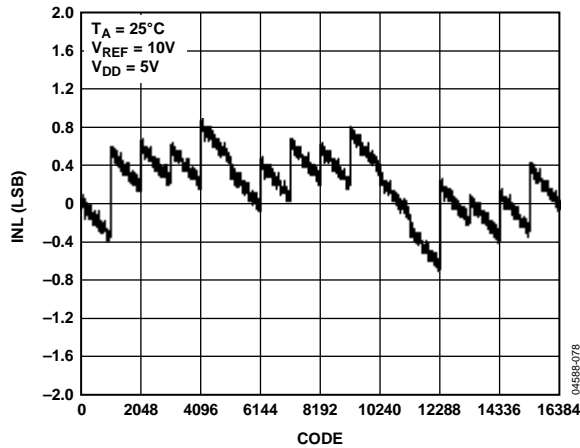

Figure 13. TUE vs. Code (14-Bit DAC)

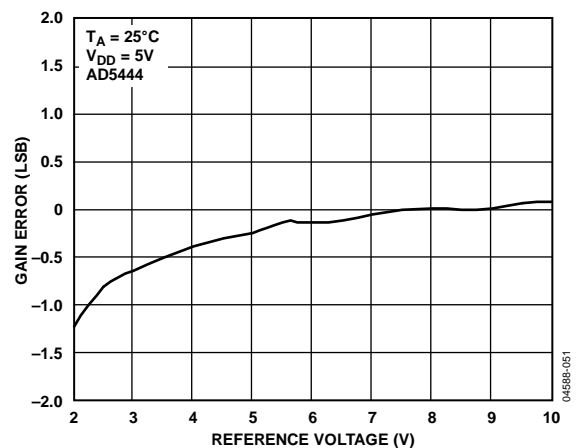

Figure 16. Gain Error vs. Reference Voltage

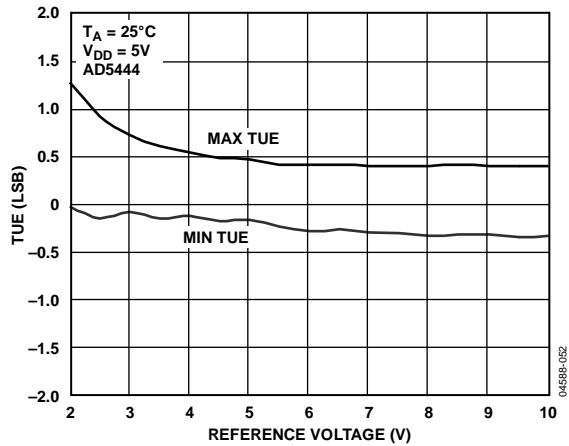

Figure 14. TUE vs. Reference Voltage

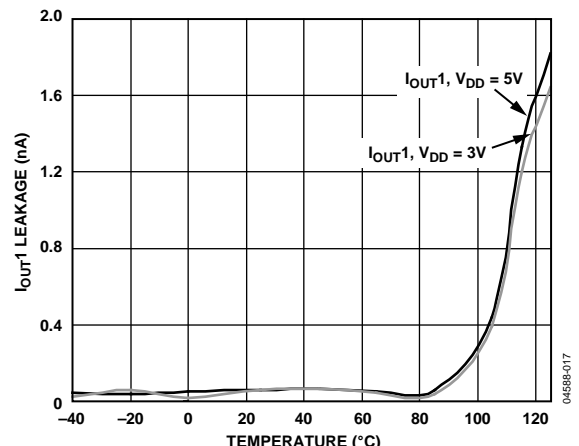

Figure 17.  $I_{OUT1}$  Leakage Current vs. Temperature

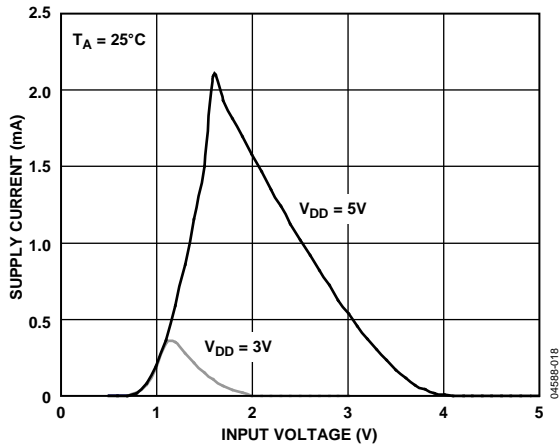

Figure 18. Supply Current vs. Logic Input Voltage

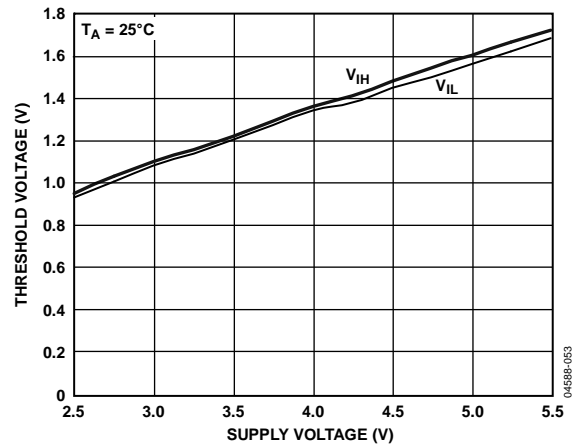

Figure 21. Threshold Voltage vs. Supply Voltage

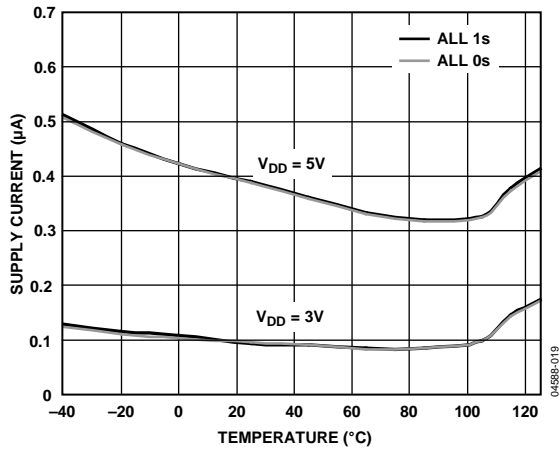

Figure 19. Supply Current vs. Temperature

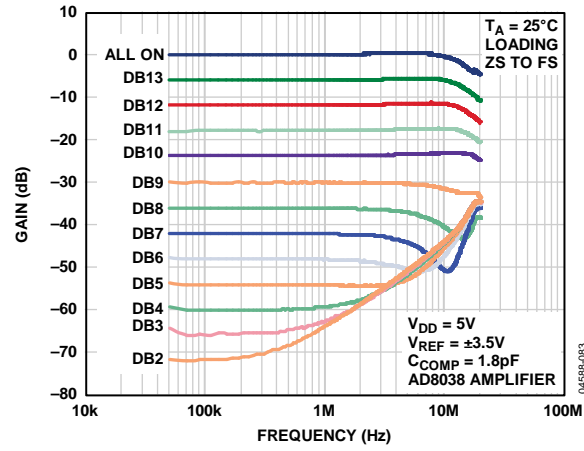

Figure 22. Reference Multiplying Bandwidth vs. Frequency and Code

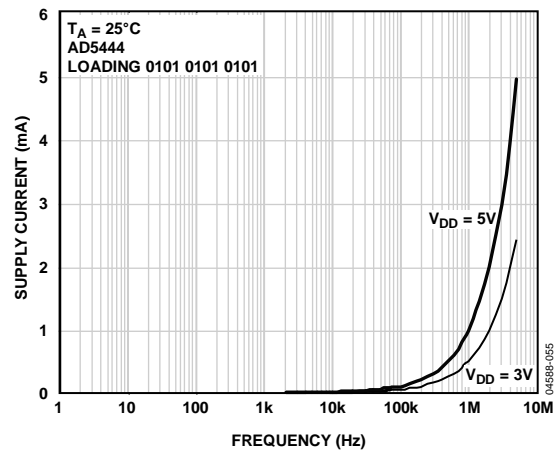

Figure 20. Supply Current vs. Update Rate

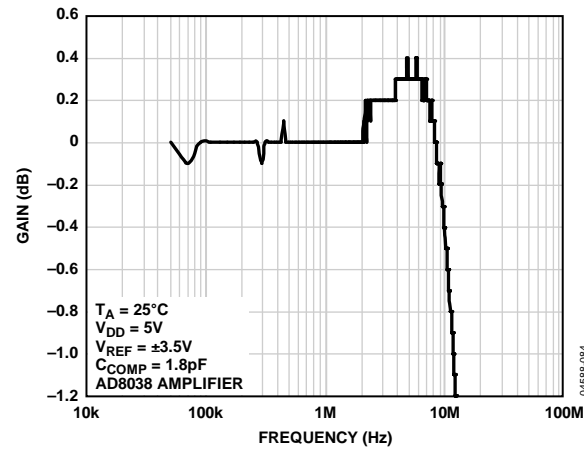

Figure 23. Reference Multiplying Bandwidth vs. Frequency—All 1s Loaded

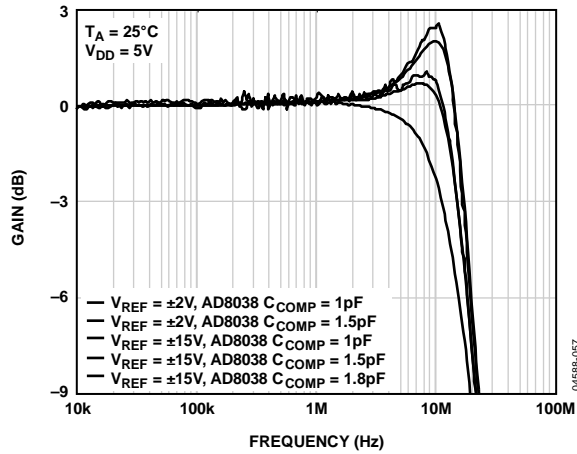

Figure 24. Reference Multiplying Bandwidth vs. Frequency and Compensation Capacitor

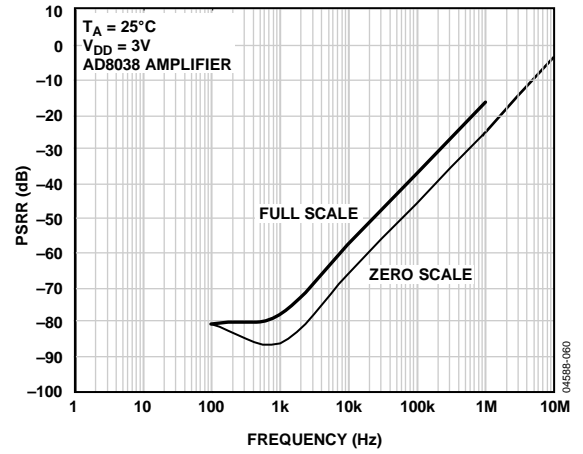

Figure 27. Power Supply Rejection Ratio vs. Frequency

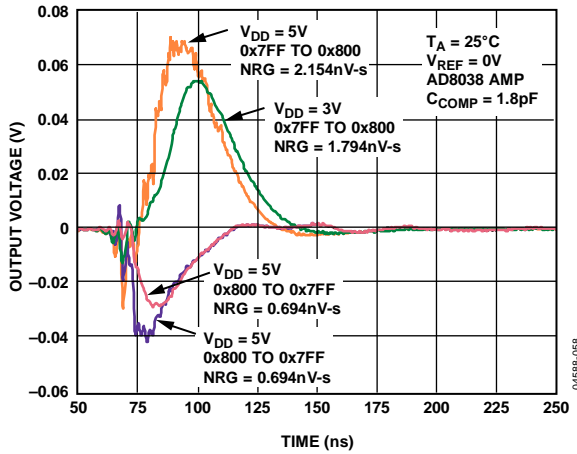

Figure 25. Midscale Transition,  $V_{REF} = 0V$

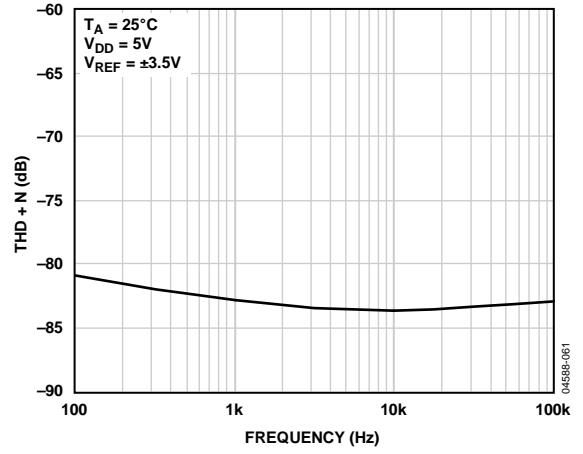

Figure 28. THD + Noise vs. Frequency

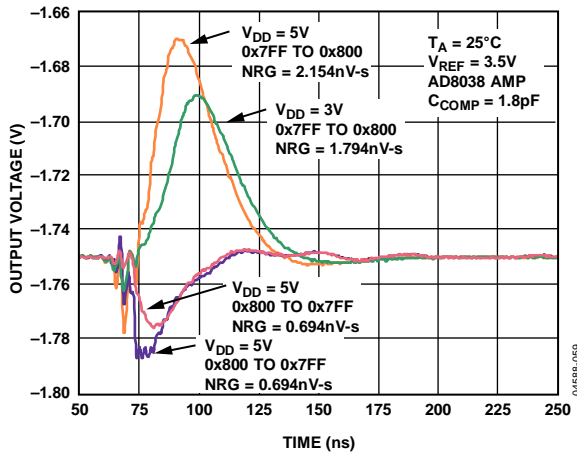

Figure 26. Midscale Transition,  $V_{REF} = 3.5V$

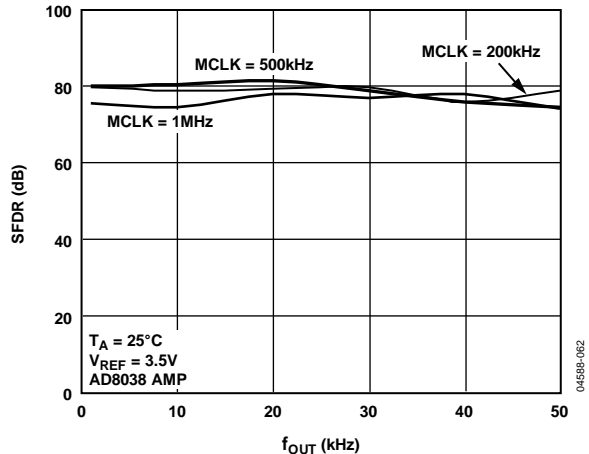

Figure 29. Wideband SFDR vs.  $f_{OUT}$  Frequency

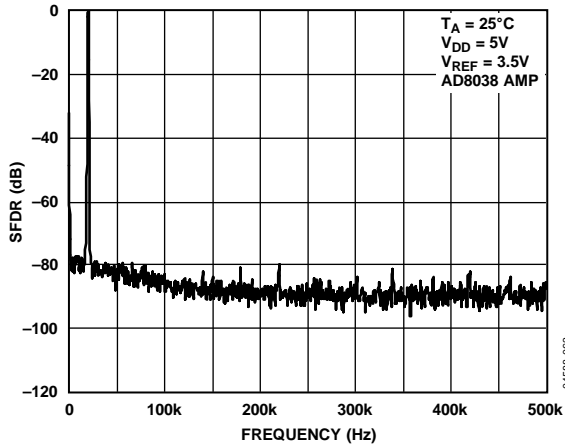

Figure 30. Wideband SFDR,  $f_{OUT} = 20\text{ kHz}$ , Clock = 1 MHz

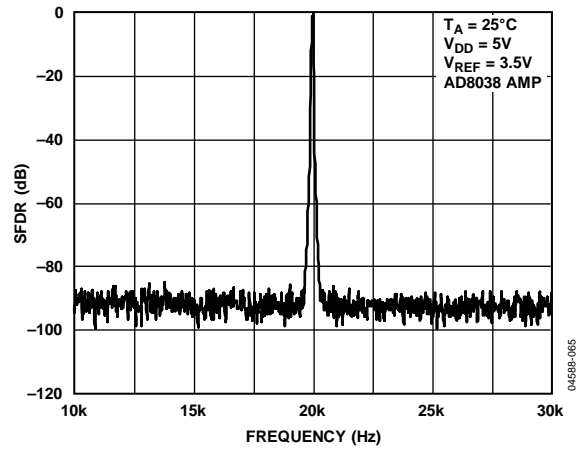

Figure 32. Narrow-Band SFDR,  $f_{OUT} = 20\text{ kHz}$ , Clock = 1 MHz

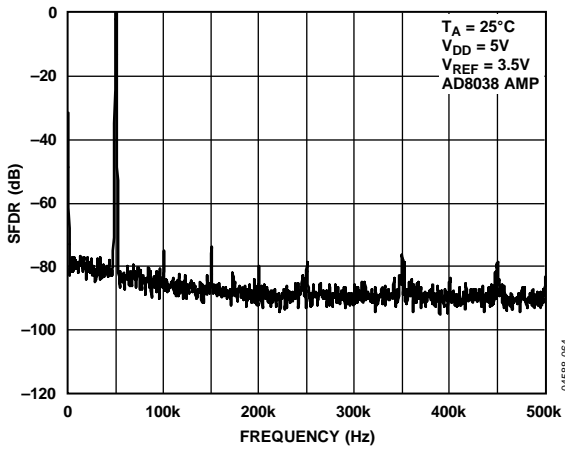

Figure 31. Wideband SFDR,  $f_{OUT} = 50\text{ kHz}$ , Clock = 1 MHz

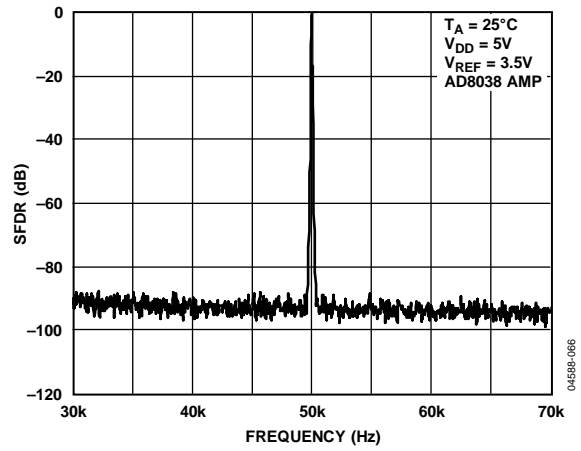

Figure 33. Narrow-Band SFDR,  $f_{OUT} = 50\text{ kHz}$ , Clock = 1 MHz

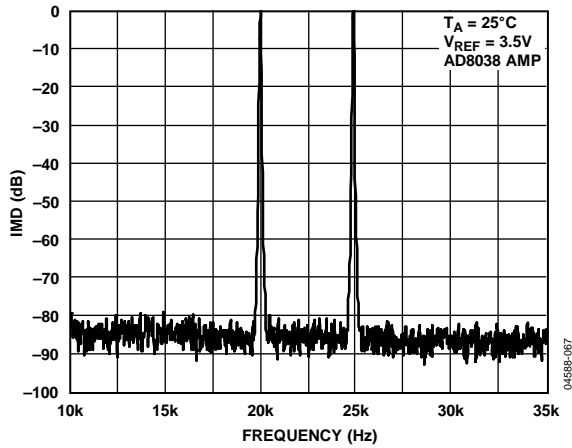

Figure 34. Narrow-Band IMD,  $f_{OUT} = 20\text{ kHz}$  and  $25\text{ kHz}$ , Clock = 1 MHz

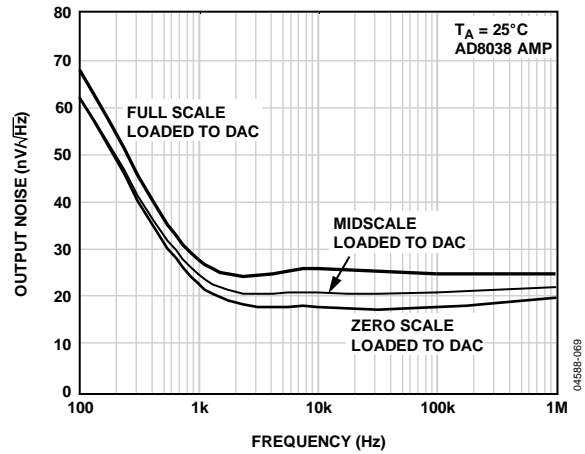

Figure 36. Output Noise Spectral Density

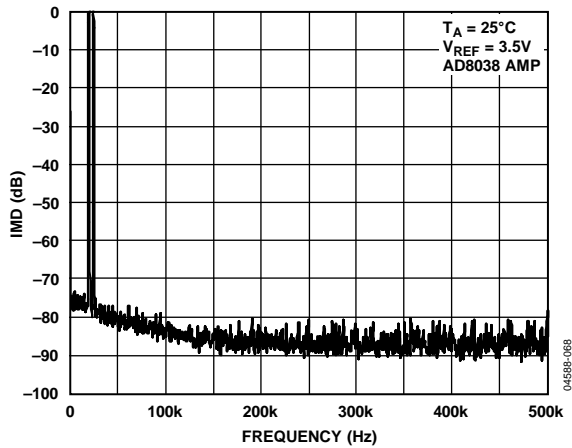

Figure 35. Wideband IMD,  $f_{OUT} = 20\text{ kHz}$  and  $25\text{ kHz}$ , Clock = 1 MHz

## TERMINOLOGY

### Relative Accuracy or Integral Nonlinearity

Relative accuracy or integral nonlinearity is a measure of the maximum deviation from a straight line passing through the endpoints of the DAC transfer function. It is measured after adjusting for zero scale and full scale and is normally expressed in LSBs or as a percentage of full-scale reading.

### Differential Nonlinearity

Differential nonlinearity is the difference between the measured change and the ideal 1 LSB change between any two adjacent codes. A specified differential nonlinearity of  $-1$  LSB maximum over the operating temperature range ensures monotonicity.

### Gain Error

Gain error or full-scale error is a measure of the output error between an ideal DAC and the actual device output. For this DAC, ideal maximum output is  $V_{REF} - 1$  LSB. Gain error of the DAC is adjustable to zero with external resistance.

### Output Leakage Current

Output leakage current is current that flows in the DAC ladder switches when the ladder is turned off. For the  $I_{OUT1}$  line, it can be measured by loading all 0s to the DAC and measuring the  $I_{OUT1}$  current. Minimum current flows in the  $I_{OUT2}$  line when the DAC is loaded with all 1s.

### Output Capacitance

Capacitance from  $I_{OUT1}$  or  $I_{OUT2}$  to AGND.

### Output Current Settling Time

The amount of time it takes for the output to settle to a specified level for a full-scale input change. For this device, it is specified with a  $100\ \Omega$  resistor to ground. The settling time specification includes the digital delay from the SYNC rising edge to the full-scale output change.

### Digital-to-Analog Glitch Impulse

The amount of charge injected from the digital inputs to the analog output when the inputs change state. This is normally specified as the area of the glitch in either picoamps per second or nanovolts per second, depending upon whether the glitch is measured as a current or voltage signal.

### Digital Feedthrough

When the device is not selected, high frequency logic activity on the device's digital inputs can be capacitively coupled through the device to show up as noise on the  $I_{OUT1}$  and  $I_{OUT2}$  pins and, subsequently, into the following circuitry. This noise is digital feedthrough.

### Multiplying Feedthrough Error

Multiplying feedthrough error is due to capacitive feedthrough from the DAC reference input to the DAC  $I_{OUT1}$  line, when all 0s are loaded to the DAC.

### Total Harmonic Distortion (THD)

The DAC is driven by an ac reference. The ratio of the rms sum of the harmonics of the DAC output to the fundamental value is the THD. Usually only the lower-order harmonics, such as second to fifth, are included.

$$THD = 20 \log \frac{\sqrt{V_2^2 + V_3^2 + V_4^2 + V_5^2}}{V_1}$$

### Digital Intermodulation Distortion

Second-order intermodulation (IMD) measurements are the relative magnitudes of the fa and fb tones digitally generated by the DAC and the second-order products at  $2fa - fb$  and  $2fb - fa$ .

### Compliance Voltage Range

The maximum range of (output) terminal voltage for which the device provides the specified characteristics.

### Spurious-Free Dynamic Range (SFDR)

The usable dynamic range of a DAC before spurious noise interferes or distorts the fundamental signal. SFDR is the measure of difference in amplitude between the fundamental and the largest harmonically or nonharmonically related spur from dc to full Nyquist bandwidth (half the DAC sampling rate or  $f_s/2$ ). Narrow-band SFDR is a measure of SFDR over an arbitrary window size, in this case 50% of the fundamental. Digital SFDR is a measure of the usable dynamic range of the DAC when the signal is a digitally generated sine wave.

# GENERAL DESCRIPTION

## DAC SECTION

The AD5444/AD5446 are 12-bit and 14-bit current output DACs consisting of segmented (4 bits), inverting R- 2R ladder configurations. A simplified diagram for the 12-bit AD5444 is shown in Figure 37.

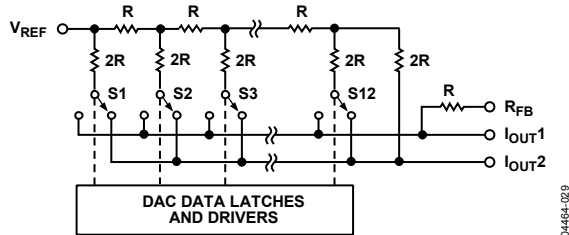

Figure 37. Simplified Ladder

The feedback resistor ( $R_{FB}$ ) has a value of  $R$ . The value of  $R$  is typically  $9\text{ k}\Omega$  ( $7\text{ k}\Omega$  minimum,  $11\text{ k}\Omega$  maximum). If  $I_{OUT1}$  is kept at the same potential as GND, a constant current flows in each ladder leg, regardless of digital input code. Therefore, the input resistance presented at  $V_{REF}$  is always constant and nominally of value  $R$ . The DAC output ( $I_{OUT1}$ ) is code-dependent, producing various resistances and capacitances. The external amplifier choice should take into account the variation in impedance generated by the DAC on the amplifiers inverting input node.

Access is provided to the  $V_{REF}$ ,  $R_{FB}$ , and both  $I_{OUT}$  terminals of the DAC, making the device extremely versatile and allowing it to be configured in several different operating modes. For example, the device provides unipolar output mode, 4-quadrant multiplication in bipolar mode, and single-supply mode of operation. Note that a matching switch is used in series with the internal  $R_{FB}$ . Power must be applied to  $V_{DD}$  to achieve continuity when measuring  $R_{FB}$ .

## CIRCUIT OPERATION

### Unipolar Mode

Using a single op amp, the AD5444/AD5446 can easily be configured to provide 2-quadrant multiplying operation or a unipolar output voltage swing, as shown in Figure 38.

When an output amplifier is connected in unipolar mode, the output voltage is given by

$$V_{OUT} = -\frac{D}{2^n} \times V_{REF}$$

where:

$D$  is the fractional representation of the digital word loaded to the DAC:

$$D = 0 \text{ to } 4095 \text{ (12-bit AD5444)}$$

$$D = 0 \text{ to } 16383 \text{ (14-bit AD5446)}$$

$n$  is the number of bits.

Note that the output voltage polarity is opposite to the  $V_{REF}$  polarity for dc reference voltages.

This DAC is designed to operate with either negative or positive reference voltages. The  $V_{DD}$  power pin is used by the internal digital logic only to drive the on and off states of the DAC switches. The DAC is also designed to accommodate ac reference input signals in the range of  $-10\text{ V}$  to  $+10\text{ V}$ . With a fixed  $+10\text{ V}$  reference, the circuit shown in Figure 38 provides a unipolar  $0\text{ V}$  to  $-10\text{ V}$  output voltage swing. When  $V_{IN}$  is an ac signal, the circuit performs 2-quadrant multiplication.

Table 5 shows the relationship between digital code and expected output voltage for unipolar operation.

Table 5. Unipolar Code

Digital Input	Analog Output (V)
1111 1111 1111	$-V_{REF}$ (4095/4096)
1000 0000 0000	$-V_{REF}$ (2048/4096) = $-V_{REF}/2$
0000 0000 0001	$-V_{REF}$ (1/4096)
0000 0000 0000	$-V_{REF}$ (0/4096) = 0

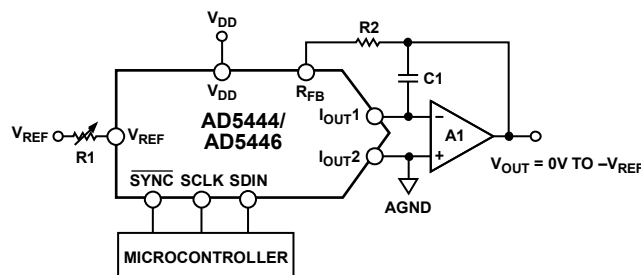

- NOTES  
 1. R1 AND R2 USED ONLY IF GAIN ADJUSTMENT IS REQUIRED.  
 2. C1 PHASE COMPENSATION (1pF TO 2pF) MAY BE REQUIRED, IF A1 IS A HIGH SPEED AMPLIFIER.

Figure 38. Unipolar Operation

### Bipolar Operation

In some applications, it may be necessary to generate a full 4-quadrant multiplying operation, or a bipolar output swing. This can easily be accomplished by using another external amplifier and some external resistors, as shown in Figure 39. In this circuit, the second amplifier (A2) provides a gain of 2. Biasing the external amplifier with an offset from the reference voltage results in a full 4-quadrant multiplying operation. The transfer function of this circuit shows that both negative and positive output voltages are created as the input data (D) is incremented from code zero ( $V_{OUT} = -V_{REF}$ ) to midscale ( $V_{OUT} = 0$  V) to full scale ( $V_{OUT} = +V_{REF}$ )

$$V_{OUT} = \left( V_{REF} \times \frac{D}{2^{n-1}} \right) - V_{REF}$$

where:

$D$  is the fractional representation of the digital word loaded to the DAC:

$$D = 0 \text{ to } 4095 \text{ (12-bit AD5444)}$$

$$D = 0 \text{ to } 16383 \text{ (14-bit AD5446)}$$

$n$  is the resolution of the DAC.

When  $V_{IN}$  is an ac signal, the circuit performs 4-quadrant multiplication.

Table 6 shows the relationship between digital code and the expected output voltage for bipolar operation.

**Table 6. Bipolar Code**

Digital Input	Analog Output (V)
1111 1111 1111	$+V_{REF}$ (2047/2048)
1000 0000 0000	0
0000 0000 0001	$-V_{REF}$ (2047/2048)
0000 0000 0000	$-V_{REF}$ (0/2048)

### Stability

In the current-to-voltage (I-to-V) configuration, the  $I_{OUT1}$  of the DAC and the inverting node of the op amp must be connected as closely as possible, and proper PCB layout techniques must be employed. Because every code change corresponds to a step function, gain peaking can occur if the op amp has limited GBP and excessive parasitic capacitance exists at the inverting node. This parasitic capacitance introduces a pole into the open-loop response that can cause ringing or instability in the closed-loop applications circuit.

An optional compensation capacitor ( $C1$ ) can be added in parallel with  $R_{FB}$  for stability, as shown in Figure 38 and Figure 39. Too small a value for  $C1$  can produce ringing at the output, while too large a value can adversely affect the settling time.  $C1$  should be found empirically, but 1 pF to 2 pF is generally adequate for the compensation.

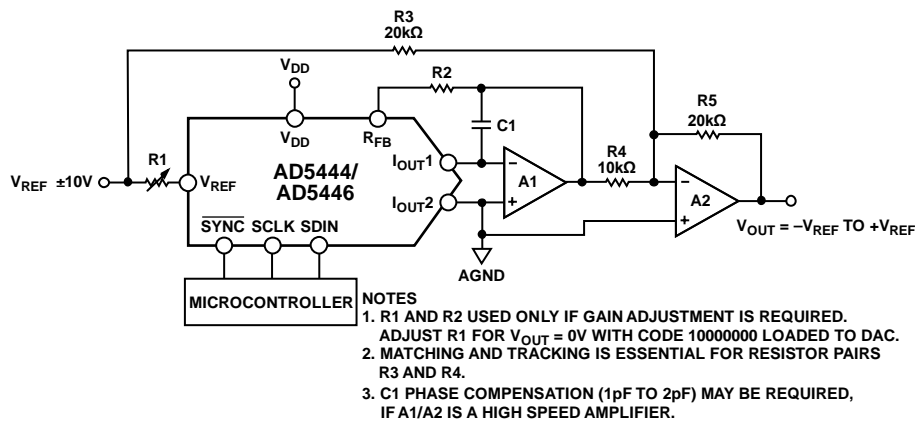

Figure 39. Bipolar Operation (4-Quadrant Multiplication)

04589-031



**SINGLE-SUPPLY APPLICATIONS**

**Voltage Switching Mode of Operation**

Figure 40 shows the AD5444/AD5446 DACs operating in the voltage switching mode. The reference voltage ( $V_{IN}$ ) is applied to the  $I_{OUT1}$  pin,  $I_{OUT2}$  is connected to AGND, and the output voltage is available at the  $V_{REF}$  terminal. In this configuration, a positive reference voltage results in a positive output voltage, making single-supply operation possible. The output from the DAC is voltage at a constant impedance (the DAC ladder resistance). Therefore, an op amp is necessary to buffer the output voltage. The reference input no longer sees a constant input impedance but rather one that varies with code, so the voltage input should be driven from a low impedance source.

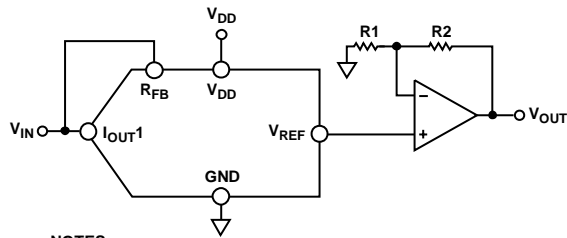

- NOTES**  
 1. ADDITIONAL PINS OMITTED FOR CLARITY.  
 2. C1 PHASE COMPENSATION (1pF TO 2pF) MAY BE REQUIRED, IF A1 IS A HIGH SPEED AMPLIFIER.

Figure 40. Single-Supply Voltage Switching Mode Operation

It is important to note that, with this configuration,  $V_{IN}$  is limited to low voltages, because the switches in the DAC ladder do not have the same source-drain drive voltage. As a result, their on resistance differs, which degrades the integral linearity of the DAC. In addition,  $V_{IN}$  must not go negative by more than 0.3 V, or an internal diode turns on, exceeding the maximum ratings of the device. In this type of application, the full range of the multiplying capability of the DAC is lost.

**Positive Output Voltage**

The output voltage polarity is opposite to the  $V_{REF}$  polarity for dc reference voltages. To achieve a positive voltage output, an applied negative reference to the input of the DAC is preferred over the output inversion through an inverting amplifier because of the resistor's tolerance errors. To generate a negative reference, the reference can be level-shifted by an op amp such that the  $V_{OUT}$  and GND pins of the reference become the virtual ground and  $-2.5$  V, respectively, as shown in Figure 41.

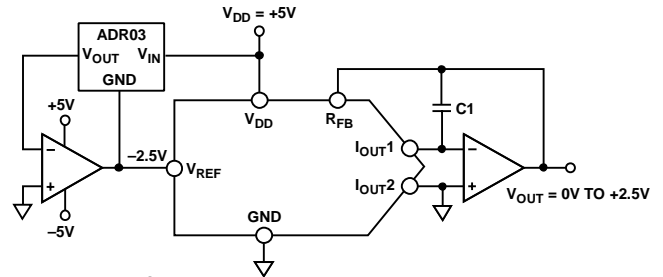

- NOTES**  
 1. ADDITIONAL PINS OMITTED FOR CLARITY.  
 2. C1 PHASE COMPENSATION (1pF TO 2pF) MAY BE REQUIRED, IF A1 IS A HIGH SPEED AMPLIFIER.

Figure 41. Positive Voltage Output with Minimum Components

**ADDING GAIN**

In applications in which the output voltage is required to be greater than  $V_{IN}$ , gain can be added with an additional external amplifier, or it can be achieved in a single stage. It is important to take into consideration the effect of the temperature coefficients of the DAC's thin film resistors. Simply placing a resistor in series with the  $R_{FB}$  resistor can cause mismatches in the temperature coefficients and result in larger gain temperature coefficient errors. Instead, increase the gain of the circuit by using the recommended configuration shown in Figure 42.  $R1$ ,  $R2$ , and  $R3$  should all have similar temperature coefficients, but they need not match the temperature coefficients of the DAC. This approach is recommended in circuits where gains of greater than 1 are required.

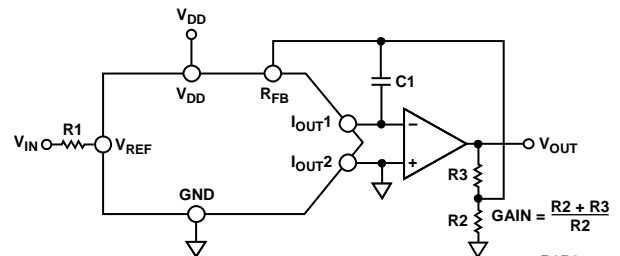

- NOTES**  
 1. ADDITIONAL PINS OMITTED FOR CLARITY.  
 2. C1 PHASE COMPENSATION (1pF TO 2pF) MAY BE REQUIRED, IF A1 IS A HIGH SPEED AMPLIFIER.

Figure 42. Increasing Gain of Current Output DAC

**DIVIDER OR PROGRAMMABLE GAIN ELEMENT**

Current-steering DACs are very flexible and lend themselves to many different applications. If this type of DAC is connected as the feedback element of an op amp and  $R_{FB}$  is used as the input resistor, as shown in Figure 43, then the output voltage is inversely proportional to the digital input fraction,  $D$ .

For  $D = 1 - 2^{-n}$ , the output voltage is

$$V_{OUT} = -V_{IN}/D = -V_{IN}/(1 - 2^{-n})$$

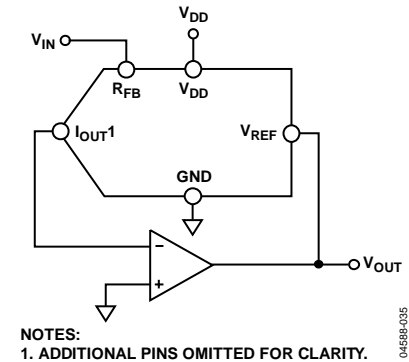

NOTES:  
1. ADDITIONAL PINS OMITTED FOR CLARITY.

Figure 43. Current-Steering DAC Used as a Divider or Programmable Gain Element

As  $D$  is reduced, the output voltage increases. For small values of the digital fraction ( $D$ ), it is important to ensure that the amplifier does not saturate and the required accuracy is met. For example, an 8-bit DAC driven with the binary code  $0x10$  (0001 0000), that is, 16 decimal, in the circuit of Figure 43, should cause the output voltage to be  $16 \times V_{IN}$ . However, if the DAC has a linearity specification of  $\pm 0.5$  LSB, then  $D$  can, in fact, have a weight in the range of  $15.5/256$  to  $16.5/256$ , so the possible output voltage is in the range  $15.5 V_{IN}$  to  $16.5 V_{IN}$ . This is an error of 3%, even though the DAC itself has a maximum error of 0.2%.

DAC leakage current is also a potential error source in divider circuits. The leakage current must be counterbalanced by an opposite current supplied from the op amp through the DAC. Because only a fraction ( $D$ ) of the current into the  $V_{REF}$  terminal is routed to the  $I_{OUT1}$  terminal, the output voltage has to change, as follows:

$$\text{Output Error Voltage due to DAC Leakage} = (\text{Leakage} \times R)/D$$

where  $R$  is the DAC resistance at the  $V_{REF}$  terminal.

For a DAC leakage current of 10 nA,  $R$  equal to 10 k $\Omega$ , and a gain ( $1/D$ ) of 16, the error voltage is 1.6 mV.

## AMPLIFIER SELECTION

The primary requirement for the current-steering mode is an amplifier with low input bias currents and low input offset voltage. The input offset voltage of an op amp is multiplied by the variable gain (due to the code-dependent output resistance of the DAC) of the circuit. A change in this noise gain between two adjacent digital fractions produces a step change in the output voltage due to the amplifier's input offset voltage. This output voltage change is superimposed upon the desired change in output between the two codes and gives rise to a differential linearity error, which, if large enough, can cause the DAC to be nonmonotonic.

The input bias current of an op amp also generates an offset at the voltage output as a result of the bias current flowing in the feedback resistor,  $R_{FB}$ . Most op amps have input bias currents low enough to prevent any significant errors in 12-bit applications.

Common-mode rejection of the op amp is important in voltage switching circuits because it produces a code-dependent error at the voltage output of the circuit. Most op amps have adequate common-mode rejection for use at 8-bit, 10-bit, and 12-bit resolutions.

Provided that the DAC switches are driven from true wideband low impedance sources ( $V_{IN}$  and AGND), they settle quickly. Consequently, the slew rate and settling time of a voltage switching DAC circuit is determined largely by the output op amp. To obtain minimum settling time in this configuration, it is important to minimize capacitance at the  $V_{REF}$  node (voltage output node in this application) of the DAC. This is done by using low input, capacitance buffer amplifiers and careful board design.

Most single-supply circuits include ground as part of the analog signal range, which, in turn, requires an amplifier that can handle rail-to-rail signals. A large range of single-supply amplifiers is available from Analog Devices, Inc. (see Table 8 and Table 9 for suitable suggestions).

## REFERENCE SELECTION

When selecting a reference for use with the AD5444/AD5446 current output DAC, pay attention to the output voltage temperature coefficient specification. This parameter affects not only the full-scale error but can also affect the linearity (INL and DNL) performance. The reference temperature coefficient should be consistent with the system accuracy specifications. For example, an 8-bit system required to hold its overall specification to within 1 LSB over the temperature range  $0^{\circ}\text{C}$  to  $50^{\circ}\text{C}$  dictates that the maximum system drift with temperature should be less than 78 ppm/ $^{\circ}\text{C}$ .

A 12-bit system with the same temperature range to overall specification within 2 LSBs requires a maximum drift of 10 ppm/ $^{\circ}\text{C}$ . By choosing a precision reference with low output temperature coefficient, this error source can be minimized. Table 7 suggests some of the dc references available from Analog Devices that are suitable for use with this range of current output DACs.

Table 7. Suitable Analog Devices Precision References

Part No.	Output Voltage (V)	Initial Tolerance Accuracy (%)	Temperature Drift Coefficient (ppm/°C)	I <sub>SS</sub> (mA)	Output Noise (μV p-p)	Package
ADR01	10	0.05	3	1	20	SOIC-8
ADR01	10	0.05	9	1	20	TSOT-23, SC70
ADR02	5	0.06	3	1	10	SOIC-8
ADR02	5	0.06	9	1	10	TSOT-23, SC70
ADR03	2.5	0.10	3	1	6	SOIC-8
ADR03	2.5	0.10	9	1	6	TSOT-23, SC70
ADR06	3	0.10	3	1	10	SOIC-8
ADR06	3	0.10	9	1	10	TSOT-23, SC70
ADR431	2.5	0.04	3	0.8	3.5	SOIC-8
ADR435	5	0.04	3	0.8	8	SOIC-8
ADR391	2.5	0.16	9	0.12	5	TSOT-23
ADR395	5	0.10	9	0.12	8	TSOT-23

Table 8. Suitable Analog Devices Precision Op Amps

Part No.	Supply Voltage (V)	V <sub>OS</sub> (Max) (μV)	I <sub>B</sub> (Max) (nA)	0.1 Hz to 10 Hz Noise (μV p-p)	Supply Current (μA)	Package
OP97	±2 to ±20	25	0.1	0.5	600	SOIC-8
OP1177	±2.5 to ±15	60	2	0.4	500	MSOP, SOIC-8
AD8551	2.7 to 5	5	0.05	1	975	MSOP, SOIC-8
AD8603	1.8 to 6	50	0.001	2.3	50	TSOT
AD8628	2.7 to 6	5	0.1	0.5	850	TSOT, SOIC-8

Table 9. Suitable Analog Devices High Speed Op Amps

Part No.	Supply Voltage (V)	BW @ ACL (Typ) (MHz)	Slew Rate (Typ) (V/μs)	V <sub>OS</sub> (Max) (μV)	I <sub>B</sub> (Max) (nA)	Package
AD8065	5 to 24	145	180	1500	0.006	SOIC-8, SOT-23, MSOP
AD8021	±2.25 to ±12	490	120	1000	10500	SOIC-8, MSOP
AD8038	3 to 12	350	425	3000	750	SOIC-8, SC70-5
AD9631	±3 to ±6	320	1300	10,000	7000	SOIC-8

## SERIAL INTERFACE

The AD5444/AD5446 have an easy-to-use, 3-wire interface that is compatible with SPI, QSPI, MICROWIRE, and DSP interface standards. Data is written to the device in 16-bit words. This 16-bit word consists of two control bits, 12 data bits or 14 data bits, as shown in Figure 44 and Figure 45. The AD5446 uses all 14 bits of DAC data while AD5444 uses 12 bits and ignores the 2 LSBs.

Control Bit C1 and Control Bit C0 allow the user to load and update the new DAC code and to change the active clock edge. By default, the shift register clocks data on the falling edge, but this can be changed via the control bits. If changed, the DAC core is inoperative until the next data frame. A power cycle resets this back to the default condition. On-chip, power-on reset circuitry ensures the device powers on with zero scale loaded to the DAC register and the  $I_{OUT}$  line.

**Table 10. DAC Control Bits**

C1	C0	Function Implemented
0	0	Load and update (power-on default)
0	1	Disable SDO
1	0	No operation
1	1	Clock data to shift register on rising edge

### SYNC Function

SYNC is an edge-triggered input that acts as a frame synchronization signal. Data can be transferred into the device only while SYNC is low. To start the serial data transfer, SYNC should be taken low, observing the minimum SYNC falling to the SCLK falling edge setup time,  $t_4$ . To minimize the power consumption of the device, the interface powers up fully only when the device is being written to, that is, on the falling edge of SYNC.

The SCLK and DIN input buffers are powered down on the rising edge of SYNC.

After the falling edge of the 16th SCLK pulse, bring SYNC high to transfer data from the input shift register to the DAC register.

### Daisy-Chain Mode

Daisy-chain mode is the default power-on mode. To disable the daisy-chain function, write 01 to the control word. In daisy-chain mode, the internal gating on the SCLK is disabled. The SCLK is continuously applied to the input shift register when SYNC is low. If more than 16 clock pulses are applied, the data ripples out of the shift register and appears on the SDO line. This data is clocked out on the rising edge of the SCLK (this is the default; use the control word to change the active edge) and is valid for the next device on the falling edge (default). By connecting this line to the SDIN input on the next device in the chain, a multidevice interface is constructed. Sixteen clock pulses are required for each device in the system. Therefore, the total number of clock cycles must equal  $16N$ , where  $N$  is the number of devices in the chain.

When the serial transfer to all devices is complete, SYNC should be taken high. This prevents any further data from being clocked into the shift register. A burst clock containing the exact number of clock cycles can be used, and SYNC can be taken high some time later. After the rising edge of SYNC, data is automatically transferred from each device's input register to the addressed DAC.

When the control bits = 10, the device is in no operation mode. This can be useful in daisy-chain applications where the user does not want to change the settings of a particular DAC in the chain. Simply write 10 to the control bits for that DAC and the following data bits are ignored.

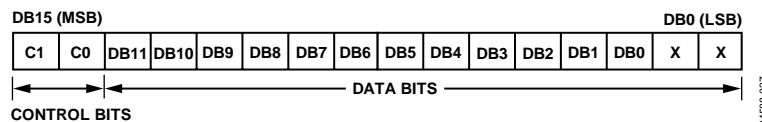

Figure 44. AD5444 12-Bit Input Shift Register Contents

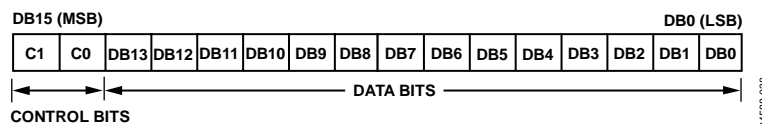

Figure 45. AD5446 14-Bit Input Shift Register Contents

**MICROPROCESSOR INTERFACING**

Microprocessor interfacing to the AD5444/AD5446 DAC is through a serial bus that uses standard protocol compatible with microcontrollers and DSP processors. The communications channel is a 3-wire interface consisting of a clock signal, a data signal, and a synchronization signal. The AD5444/AD5446 requires a 16-bit word, with the default being data valid on the falling edge of SCLK, but this can be changed using the control bits in the data-word.

**ADSP-21xx to AD5444/AD5446 Interface**

The ADSP-21xx family of DSPs is easily interfaced to the AD5444/AD5446 DAC without the need for extra glue logic. Figure 46 is an example of an SPI interface between the DAC and the ADSP-2191M. SCK of the DSP drives the serial clock line, SCLK. SYNC is driven from one of the port lines, in this case SPIxSEL.

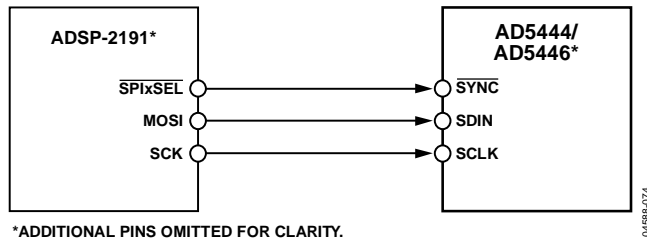

\*ADDITIONAL PINS OMITTED FOR CLARITY. 04688-074

Figure 46. ADSP-2191M SPI to AD5444/AD5446 Interface

A serial interface between the DAC and DSP SPORT is shown in Figure 47. In this interface example, SPORT0 is used to transfer data to the DAC shift register. Transmission is initiated by writing a word to the Tx register after the SPORT has been enabled. In a write sequence, data is clocked out on each rising edge of the DSP serial clock and clocked into the DAC input shift register on the falling edge of its SCLK. The update of the DAC output takes place on the rising edge of the SYNC signal.

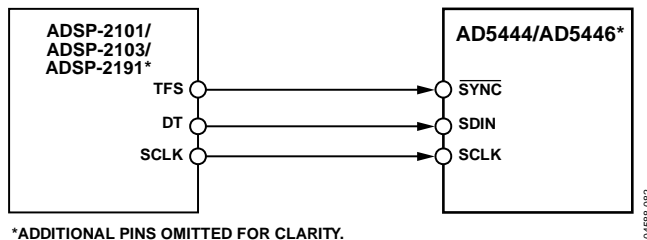

\*ADDITIONAL PINS OMITTED FOR CLARITY. 04688-082

Figure 47. ADSP-2101/ADSP-2103/ADSP-2191 SPORT to AD5444/AD5446 Interface

Communication between two devices at a given clock speed is possible when the following specifications are compatible: frame sync delay and frame sync setup-and-hold, data delay and data setup-and-hold, and SCLK width. The DAC interface expects a  $t_4$  (SYNC falling edge to SCLK falling edge setup time) of 13 ns minimum. See the ADSP-21xx User Manual for information on clock and frame sync frequencies for the SPORT register.

Table 11 shows the setup for the SPORT control register.

**Table 11. SPORT Control Register Setup**

Name	Setting	Description
TFSW	1	Alternate framing
INVTFS	1	Active low frame signal
DTYPE	00	Right-justify data
ISCLK	1	Internal serial clock
TFSR	1	Frame every word
ITFS	1	Internal framing signal
SLEN	1111	16-bit data-word

**ADSP-BF5xx to AD5444/AD5446 Interface**

The ADSP-BF5xx family of processors has an SPI-compatible port that enables the processor to communicate with SPI-compatible devices. A serial interface between the ADSP-BF5xx and the AD5444/AD5446 DAC is shown in Figure 48. In this configuration, data is transferred through the MOSI (master output/slave input) pin. SYNC is driven by the SPI chip select pin, which is a reconfigured programmable flag pin.

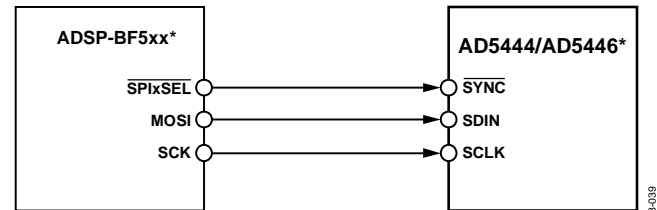

\*ADDITIONAL PINS OMITTED FOR CLARITY. 04688-039

Figure 48. ADSP-BF5xx to AD5444/AD5446 Interface

The ADSP-BF5xx processor incorporates channel synchronous serial ports (SPORT). A serial interface between the DAC and the DSP SPORT is shown in Figure 49. When the SPORT is enabled, initiate transmission by writing a word to the Tx register. The data is clocked out on each rising edge of the DSPs serial clock and clocked into the DAC input shift register on the falling edge of its SCLK. The DAC output is updated by using the transmit frame synchronization (TFS) line to provide a SYNC signal.

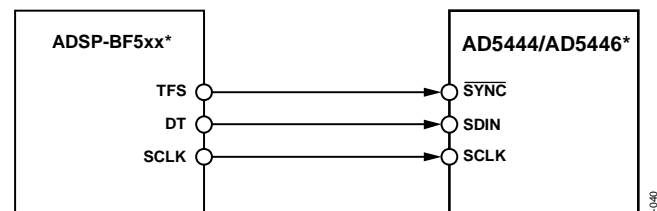

\*ADDITIONAL PINS OMITTED FOR CLARITY. 04688-040

Figure 49. ADSP-BF5xx to AD5444/AD5446 Interface

## 80C51/80L51 to AD5444/AD5446 Interface

A serial interface between the DAC and the 80C51/80L51 is shown in Figure 50. TxD of the 80C51/80L51 drives SCLK of the DAC serial interface, while RxD drives the serial data line, SDIN. P1.1 is a bit-programmable pin on the serial port and is used to drive SYNC. When data is to be transmitted to the switch, P1.1 is taken low. The 80C51/80L51 transmits data only in 8-bit bytes; therefore, only eight falling clock edges occur in the transmit cycle. To load data correctly to the DAC, P1.1 is left low after the first eight bits are transmitted, and a second write cycle is initiated to transmit the second byte of data.

Data on RxD is clocked out of the microcontroller on the rising edge of TxD and is valid on the falling edge. As a result, no glue logic is required between the DAC and microcontroller interface. P1.1 is taken high following the completion of this cycle. The 80C51/80L51 provides the LSB of its SBUF register as the first bit in the data stream. The DAC input register requires its data with the MSB as the first bit received. The transmit routine should take this into account.

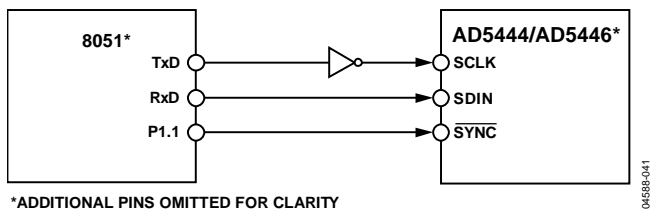

\*ADDITIONAL PINS OMITTED FOR CLARITY

Figure 50. 80C51/80L51 to AD5444/AD5446 Interface

## MC68HC11 Interface to AD5444/AD5446 Interface

Figure 51 is an example of a serial interface between the DAC and the MC68HC11 microcontroller. The serial peripheral interface (SPI) on the MC68HC11 is configured for master mode (MSTR) = 1, clock polarity bit (CPOL) = 0, and the clock phase bit (CPHA) = 1. The SPI is configured by writing to the SPI control register (SPCR); see the *68HC11 User Manual*. SCK of the 68HC11 drives the SCLK of the DAC interface, the MOSI output drives the serial data line (SDIN) of the AD5444/AD5446.

The SYNC signal is derived from a port line (PC7). When data is being transmitted to the AD5444/AD5446, the SYNC line is taken low (PC7). Data appearing on the MOSI output is valid on the falling edge of SCK. Serial data from the 68HC11 is transmitted in 8-bit bytes with only eight falling clock edges occurring in the transmit cycle. Data is transmitted MSB first. To load data to the DAC, PC7 is left low after the first eight bits are transferred, and a second serial write operation is performed to the DAC. PC7 is taken high at the end of this procedure.

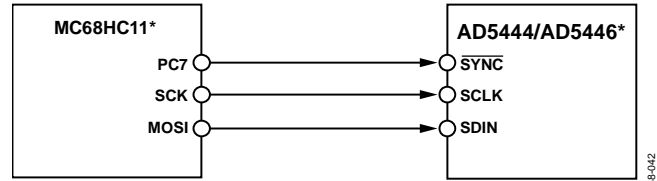

\*ADDITIONAL PINS OMITTED FOR CLARITY

Figure 51. MC68HC11 to AD5444/AD5446 Interface

If the user wants to verify the data previously written to the input shift register, the SDO line can be connected to MISO of the MC68HC11, and, with SYNC low, the shift register clocks data out on the rising edges of SCLK.

## MICROWIRE to AD5444/AD5446 Interface

Figure 52 shows an interface between the DAC and any MICROWIRE-compatible device. Serial data is shifted out on the falling edge of the serial clock, SK, and is clocked into the DAC input shift register on the rising edge of SK, which corresponds to the falling edge of the DAC SCLK.

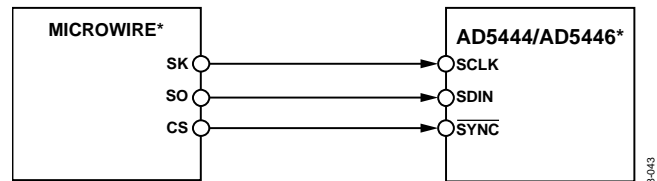

\*ADDITIONAL PINS OMITTED FOR CLARITY

Figure 52. MICROWIRE to AD5444/AD5446 Interface

## PIC16C6x/7x to AD5444/AD5446 Interface

The PIC16C6x/7x synchronous serial port (SSP) is configured as an SPI master with the clock polarity bit (CKP) = 0. This is done by writing to the synchronous serial port control register (SSPCON); see the *PIC16/17 Microcontroller User Manual*.

In this example, I/O port RA1 is used to provide a SYNC signal and enable the serial port of the DAC. This microcontroller transfers only eight bits of data during each serial transfer operation; therefore, two consecutive write operations are required. Figure 53 shows the connection diagram.

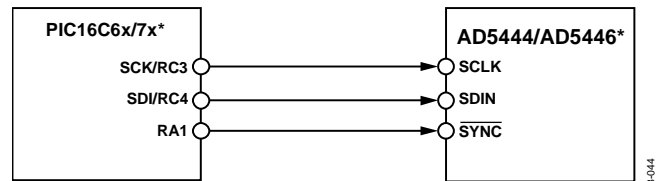

\*ADDITIONAL PINS OMITTED FOR CLARITY

Figure 53. PIC16C6x/7x to AD5444/AD5446 Interface

## PCB LAYOUT AND POWER SUPPLY DECOUPLING

In any circuit where accuracy is important, careful consideration of the power supply and ground return layout helps to ensure the rated performance. The printed circuit boards on which the AD5444/AD5446 are mounted should be designed so the analog and digital sections are separated and confined to certain areas of the board. If the DACs are in systems in which multiple devices require a AGND-to-DGND connection, the connection should be made at one point only. The star ground point should be established as close as possible to the devices.

The DAC should have ample supply bypassing of 10  $\mu\text{F}$  in parallel with 0.1  $\mu\text{F}$  on the supply located as close to the package as possible, ideally right up against the device. The 0.1  $\mu\text{F}$  capacitor should have low effective series resistance (ESR) and effective series inductance (ESI), like the common ceramic types that provide a low impedance path to ground at high frequencies, to handle transient currents due to internal logic switching. Low ESR, 1  $\mu\text{F}$  to 10  $\mu\text{F}$  tantalum or electrolytic capacitors should also be applied at the supplies to minimize transient disturbance and filter out low frequency ripple.

Fast switching signals such as clocks should be shielded with digital ground to avoid radiating noise to other parts of the board, and should never be run near the reference inputs.

Avoid crossover of digital and analog signals. Traces on opposite sides of the board should run at right angles to each other. This reduces the effects of feedthrough throughout the board.

A microstrip technique, by far the best, is not always possible with a double-sided board. In this technique, the component side of the board is dedicated to the ground plane, while signal traces are placed on the solder side.

It is good practice to employ compact, minimum lead-length PCB layout design. Leads to the input should be as short as possible to minimize IR drops and stray inductance.

The PCB metal traces between  $V_{\text{REF}}$  and  $R_{\text{FB}}$  should also be matched to minimize gain error. To maximize high frequency performance, the I-to-V amplifier should be located as close to the device as possible.

## OVERVIEW OF AD54xx AND AD55xx CURRENT OUTPUT DEVICES

Table 12.

Part Number	Resolution (Bits)	Number of DACs	INL (LSB)	Interface	Package <sup>1</sup>	Features
AD5424	8	1	±0.25	Parallel	RU-16, CP-20	10 MHz BW, 17 ns $\overline{CS}$ pulse width
AD5426	8	1	±0.25	Serial	RM-10	10 MHz BW, 50 MHz serial
AD5428	8	2	±0.25	Parallel	RU-20	10 MHz BW, 17 ns $\overline{CS}$ pulse width
AD5429	8	2	±0.25	Serial	RU-10	10 MHz BW, 50 MHz serial
AD5450	8	1	±0.25	Serial	UJ-8	12 MHz BW, 50 MHz serial
AD5432	10	1	±0.5	Serial	RM-10	10 MHz BW, 50 MHz serial
AD5433	10	1	±0.5	Parallel	RU-20, CP-20	10 MHz BW, 17 ns $\overline{CS}$ pulse width
AD5439	10	2	±0.5	Serial	RU-16	10 MHz BW, 50 MHz serial
AD5440	10	2	±0.5	Parallel	RU-24	10 MHz BW, 17 ns $\overline{CS}$ pulse width
AD5451	10	1	±0.25	Serial	UJ-8	12 MHz BW, 50 MHz serial
AD5443	12	1	±1	Serial	RM-10	10 MHz BW, 50 MHz serial
AD5444	12	1	±0.5	Serial	RM-10	12 MHz BW, 50 MHz serial interface
AD5415	12	2	±1	Serial	RU-24	10 MHz BW, 50 MHz serial
AD5405	12	2	±1	Parallel	CP-40	10 MHz BW, 17 ns $\overline{CS}$ pulse width
AD5445	12	2	±1	Parallel	RU-20, CP-20	10 MHz BW, 17 ns $\overline{CS}$ pulse width
AD5447	12	2	±1	Parallel	RU-24	10 MHz BW, 17 ns $\overline{CS}$ pulse width
AD5449	12	2	±1	Serial	RU-16	10 MHz BW, 50 MHz serial
AD5452	12	1	±0.5	Serial	UJ-8, RM-8	12 MHz BW, 50 MHz serial
AD5446	14	1	±1	Serial	RM-10	12 MHz BW, 50 MHz serial
AD5453	14	1	±2	Serial	UJ-8, RM-8	12 MHz BW, 50 MHz serial
AD5553	14	1	±1	Serial	RM-8	4 MHz BW, 50 MHz serial clock
AD5556	14	1	±1	Parallel	RU-28	4 MHz BW, 20 ns $\overline{WR}$ pulse width
AD5555	14	2	±1	Serial	RM-8	4 MHz BW, 50 MHz serial clock
AD5557	14	2	±1	Parallel	RU-38	4 MHz BW, 20 ns $\overline{WR}$ pulse width
AD5543	16	1	±2	Serial	RM-8	4 MHz BW, 50 MHz serial clock
AD5546	16	1	±2	Parallel	RU-28	4 MHz BW, 20 ns $\overline{WR}$ pulse width
AD5545	16	2	±2	Serial	RU-16	4 MHz BW, 50 MHz serial clock
AD5547	16	2	±2	Parallel	RU-38	4 MHz BW, 20 ns $\overline{WR}$ pulse width

<sup>1</sup> RU = TSSOP, CP = LFCSP, RM = MSOP, UJ = TSOT.



## OUTLINE DIMENSIONS

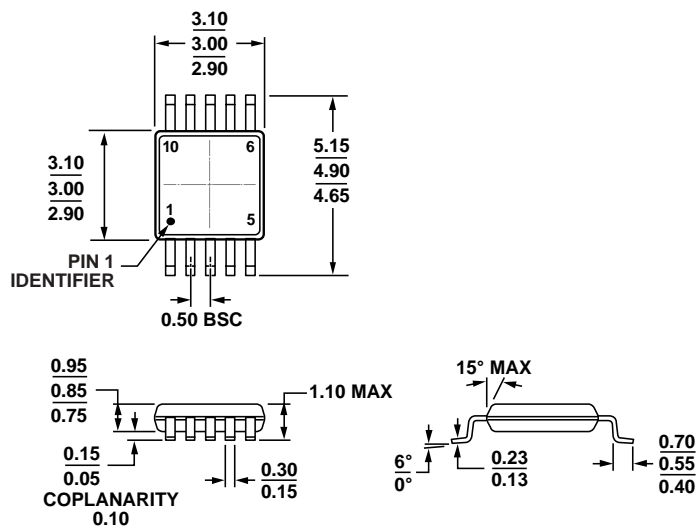

COMPLIANT TO JEDEC STANDARDS MO-187-BA

Figure 54. 10-Lead Mini Small Outline Package [MSOP]  
(RM-10)

Dimensions shown in millimeters

091705-A

## ORDERING GUIDE

Model <sup>1</sup>	Resolution (Bits)	INL (LSB)	Temperature Range	Package Description	Package Option	Branding
AD5444YRM	12	±0.5	−40°C to +125°C	10-Lead MSOP	RM-10	D27
AD5444YRM-REEL	12	±0.5	−40°C to +125°C	10-Lead MSOP	RM-10	D27
AD5444YRM-REEL7	12	±0.5	−40°C to +125°C	10-Lead MSOP	RM-10	D27
AD5444YRMZ	12	±0.5	−40°C to +125°C	10-Lead MSOP	RM-10	D6X
AD5444YRMZ-REEL	12	±0.5	−40°C to +125°C	10-Lead MSOP	RM-10	D6X
AD5444YRMZ-REEL7	12	±0.5	−40°C to +125°C	10-Lead MSOP	RM-10	D6X
AD5446YRM	14	±2	−40°C to +125°C	10-Lead MSOP	RM-10	D28
AD5446YRM-REEL	14	±2	−40°C to +125°C	10-Lead MSOP	RM-10	D28
AD5446YRM-REEL7	14	±2	−40°C to +125°C	10-Lead MSOP	RM-10	D28
AD5446YRMZ	14	±2	−40°C to +125°C	10-Lead MSOP	RM-10	D7Z
AD5446YRMZ-RL7	14	±2	−40°C to +125°C	10-Lead MSOP	RM-10	D7Z
EVAL-AD5446SDZ				Evaluation Board		

<sup>1</sup> Z = RoHS Compliant Part.

**NOTES**

**NOTES**

**NOTES**

Компания «Life Electronics» занимается поставками электронных компонентов импортного и отечественного производства от производителей и со складов крупных дистрибьюторов Европы, Америки и Азии.

С конца 2013 года компания активно расширяет линейку поставок компонентов по направлению коаксиальный кабель, кварцевые генераторы и конденсаторы (керамические, пленочные, электролитические), за счёт заключения дистрибьюторских договоров

Мы предлагаем:

- Конкуренеспособные цены и скидки постоянным клиентам.
- Специальные условия для постоянных клиентов.
- Подбор аналогов.
- Поставку компонентов в любых объемах, удовлетворяющих вашим потребностям.
- Приемлемые сроки поставки, возможна ускоренная поставка.
- Доставку товара в любую точку России и стран СНГ.
- Комплексную поставку.
- Работу по проектам и поставку образцов.
- Формирование склада под заказчика.
- Сертификаты соответствия на поставляемую продукцию (по желанию клиента).
- Тестирование поставляемой продукции.
- Поставку компонентов, требующих военную и космическую приемку.
- Входной контроль качества.
- Наличие сертификата ISO.

В составе нашей компании организован Конструкторский отдел, призванный помогать разработчикам, и инженерам.

Конструкторский отдел помогает осуществить:

- Регистрацию проекта у производителя компонентов.
- Техническую поддержку проекта.
- Защиту от снятия компонента с производства.
- Оценку стоимости проекта по компонентам.
- Изготовление тестовой платы монтаж и пусконаладочные работы.



Тел: +7 (812) 336 43 04 (многоканальный)

Email: [org@lifeelectronics.ru](mailto:org@lifeelectronics.ru)