

**Agency Approval**

| Agency | Agency File Number |
|--------|--------------------|
|        | L Package : E71639 |

**Schematic Symbol**

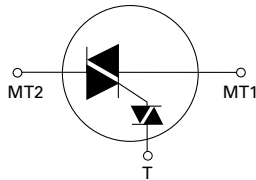

**Main Features**

| Symbol              | Value      | Unit |
|---------------------|------------|------|
| $I_{T(RMS)}$        | 4 to 15    | A    |
| $V_{DRM} / V_{RRM}$ | 400 to 600 | V    |
| DIAC $V_{BO}$       | 33 to 43   | V    |

**Description**

The Quadrac is an internally triggered Triac designed for AC switching and phase control applications. It is a Triac and DIAC in a single package, which saves user expense by eliminating the need for separate Triac and DIAC components.

Standard type devices normally operate in Quadrants I & III triggered from AC line.

Alternistor type Quadracs are used in circuits requiring high dv/dt capability.

**Features & Benefits**

- RoHS Compliant
- Glass – passivated junctions
- Voltage capability up to 600 V
- Surge capability up to 200 A

**Applications**

Excellent for AC switching and phase control applications such as lighting and heating. Typical applications are AC solid-state switches, light dimmers, power tools, home/ brown goods and white goods appliances.

Alternistor Quadracs (no snubber required) are used in applications with extremely inductive loads requiring highest commutation performance.

Internally constructed isolated package is offered for ease of heat sinking with highest isolation voltage.

**Absolute Maximum Ratings**

| Symbol       | Parameter                                 | Value   |                    |                    |                    |                    | Unit                   |   |
|--------------|---|---|--------------------|--------------------|--------------------|--------------------|------------------------|---|
|              |   | Qxx04LT   | Qxx06LT / Qxx06LTH | Qxx08LT / Qxx08LTH | Qxx10LT / Qxx10LTH | Qxx15LT / Qxx15LTH |                        |   |
| $I_{T(RMS)}$ | RMS forward current                       | Qxx04LT: $T_C = 95^\circ\text{C}$<br>Qxx06LT/Qxx08LT/Qxx10LT: $T_C = 90^\circ\text{C}$<br>Qxx15LT: $T_C = 80^\circ\text{C}$ |                    |                    |                    |                    | A                      |   |
| $I_{TSM}$    | Peak non-repetitive surge current         | single half cycle; $f = 50\text{Hz}$ ;<br>$T_J$ (initial) = $25^\circ\text{C}$  | 46                 | 65                 | 83                 | 100                | 167                    | A |
|              |   | single half cycle; $f = 60\text{Hz}$ ;<br>$T_J$ (initial) = $25^\circ\text{C}$  | 55                 | 80                 | 100                | 120                | 200                    |   |
| $I^2t$       | $I^2t$ value for fusing                   | $t_p = 8.3\text{ms}$  |                    |                    |                    |                    | $\text{A}^2\text{s}$   |   |
| $di/dt$      | Critical rate-of-rise of on-state current | $f = 60\text{Hz}$ ; $T_J = 125^\circ\text{C}$   |                    |                    |                    |                    | $\text{A}/\mu\text{s}$ |   |
| $I_{GM}$     | Peak gate current                         | $T_J = 125^\circ\text{C}$   |                    |                    |                    |                    | A                      |   |
| $T_{stg}$    | Storage temperature range                 | -40 to 150  |                    |                    |                    |                    | $^\circ\text{C}$       |   |
| $T_J$        | Operating junction temperature range      | -40 to 125  |                    |                    |                    |                    | $^\circ\text{C}$       |   |

Note: xx = voltage

**Electrical Characteristics ( $T_J = 25^\circ\text{C}$ , unless otherwise specified) – Standard Quadrac**

| Symbol     | Test Conditions   |      | Value   |         |         |         |         | Unit                   |                        |
|------------|---|------|---------|---------|---------|---------|---------|------------------------|------------------------|
|            |   |      | Qxx04LT | Qxx06LT | Qxx08LT | Qxx10LT | Qxx15LT |                        |                        |
| $I_H$      | $I_T = 200\text{mA}$ (initial)  | MAX. | 40      | 50      | 60      | 60      | 70      | mA                     |                        |
| $dv/dt$    | $V_D = V_{DRM}$ ; gate open; $T_J = 100^\circ\text{C}$                      | MIN. | 400V    | 75      | 150     | 175     | 200     | 300                    | $\text{V}/\mu\text{s}$ |
|            |   | MIN. | 600V    | 50      | 125     | 150     | 175     | 200                    |                        |
| $dv/dt$    | $V_D = V_{DRM}$ ; gate open; $T_J = 125^\circ\text{C}$                      | MIN. | 400V    | 50      | 100     | 120     | 150     | 200                    | $\text{V}/\mu\text{s}$ |
|            |   | MIN. | 600V    | 50      | 85      | 100     | 120     | 150                    |                        |
| $dv/dt(c)$ | $di/dt(c) = 0.54 \times I_{T(RMS)} / \text{ms}$ ; $T_J = 125^\circ\text{C}$ | MIN. | 3       | 4       |         |         |         | $\text{V}/\mu\text{s}$ |                        |
| $t_{gt}$   | (note 1)  | TYP. | 3       |         |         |         |         | $\mu\text{s}$          |                        |

(1) Reference test circuit in figure 10 and waveform in figure 11;  $C_T = 0.1\mu\text{F}$  with  $0.1\mu\text{s}$  rise time.

Note: xx = voltage

**Electrical Characteristics ( $T_J = 25^\circ\text{C}$ , unless otherwise specified) – Alternistor Quadrac**

| Symbol     | Test Conditions   |      | Value    |          |          |          | Unit                   |                        |
|------------|---|------|----------|----------|----------|----------|------------------------|------------------------|
|            |   |      | Qxx06LTH | Qxx08LTH | Qxx10LTH | Qxx15LTH |                        |                        |
| $I_H$      | $I_T = 20\text{mA}$ (initial)   | MAX. | 50       | 50       | 60       | 70       | mA                     |                        |
| $dv/dt$    | $V_D = V_{DRM}$ ; gate open; $T_J = 100^\circ\text{C}$                      | MIN. | 400V     | 575      |          | 925      |                        | $\text{V}/\mu\text{s}$ |
|            |   | MIN. | 600V     | 425      |          | 775      |                        |                        |
| $dv/dt$    | $V_D = V_{DRM}$ ; gate open; $T_J = 125^\circ\text{C}$                      | MIN. | 400V     | 450      |          | 700      |                        | $\text{V}/\mu\text{s}$ |
|            |   | MIN. | 600V     | 350      |          | 600      |                        |                        |
| $dv/dt(c)$ | $di/dt(c) = 0.54 \times I_{T(RMS)} / \text{ms}$ ; $T_J = 125^\circ\text{C}$ | MIN. | 25       |          | 30       |          | $\text{V}/\mu\text{s}$ |                        |
| $t_{gt}$   | (note 1)  | TYP. | 3        |          |          |          | $\mu\text{s}$          |                        |

(1) Reference test circuit in figure 10 and waveform in figure 11;  $C_T = 0.1\mu\text{F}$  with  $0.1\mu\text{s}$  rise time.

Note: xx = voltage

### Trigger DIAC Specifications

| Symbol             | Test Conditions   |      | Value | Unit    |
|--------------------|---|------|-------|---------|
| $\Delta V_{BO}$    | Breakover Voltage Symmetry                              | MAX. | 3     | V       |
| $V_{BO}$           | Breakover Voltage, forward and reverse                  | MIN. | 33    | V       |
|                    |   | MAX. | 43    |         |
| $[\Delta V_{\pm}]$ | Dynamic Breakback Voltage, forward and reverse (note 1) | MIN. | 5     | V       |
| $I_{BO}$           | Peak Breakover Current                                  | MAX. | 25    | $\mu$ A |
| $C_T$              | Trigger Firing Capacitance                              | MAX. | 0.1   | $\mu$ F |

(1) Reference test circuit in figure 10 and waveform in figure 11.

### Static Characteristics

| Symbol              | Test Conditions                                    |                     | Value | Unit |
|---------------------|--|---------------------|-------|------|
| $V_{TM}$            | $I_T = 1.41 \times I_{T(rms)}$ A; $t_p = 380\mu$ s | MAX.                | 1.6   | V    |
| $I_{DRM} / I_{RRM}$ | $V_{DRM} / V_{RRM}$                                | $T_J = 25^\circ$ C  | MAX.  | 10   |
|                     |  | $T_J = 100^\circ$ C |       | 500  |
|                     |  | $T_J = 125^\circ$ C |       | 2000 |

### Thermal Resistances

| Symbol            | Parameter             |                    | Value | Unit         |
|-------------------|-----------------------|--------------------|-------|--------------|
| $R_{\theta(J-C)}$ | Junction to case (AC) | Qxx04LT            | 3.6   | $^\circ$ C/W |
|                   |                       | Qxx06LT / Qxx06LTH | 3.3   |              |
|                   |                       | Qxx08LT / Qxx08LTH | 2.8   |              |
|                   |                       | Qxx10LT / Qxx10LTH | 2.6   |              |
|                   |                       | Qxx15LT / Qxx15LTH | 2.1   |              |
| $R_{\theta(J-A)}$ | Junction to ambient   |                    | 50    | $^\circ$ C/W |

Note : xx = voltage

**Figure 1: Normalized DC Holding Current vs. Junction Temperature**

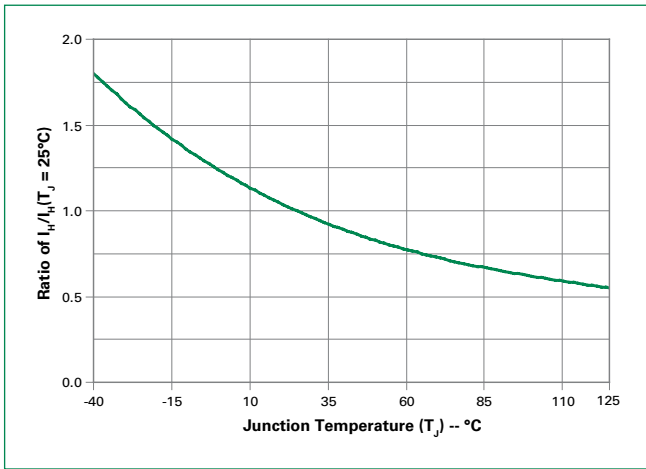

**Figure 2: On-State Current vs. On-State Voltage (Typical) (4A)**

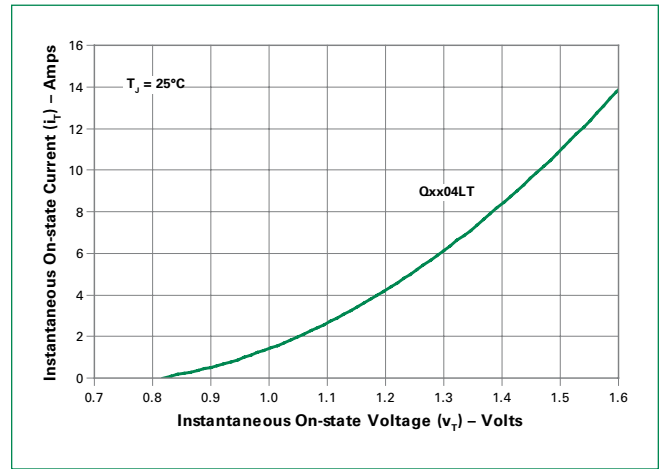

**Figure 3: On-State Current vs. On-State Voltage (Typical) (6A to 15A)**

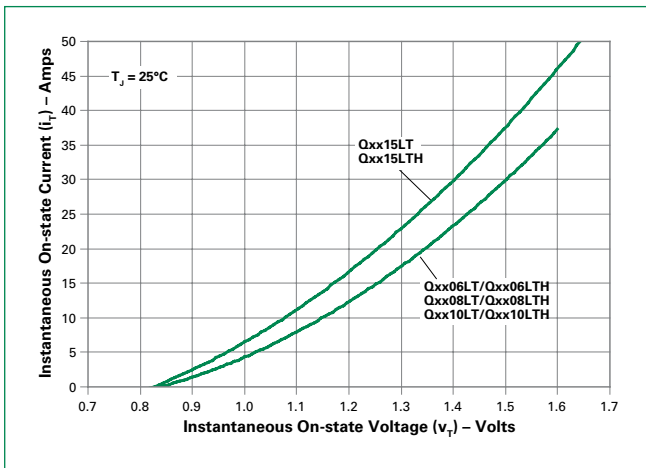

**Figure 4: Power Dissipation vs. RMS On-State Current (Typical) (4A)**

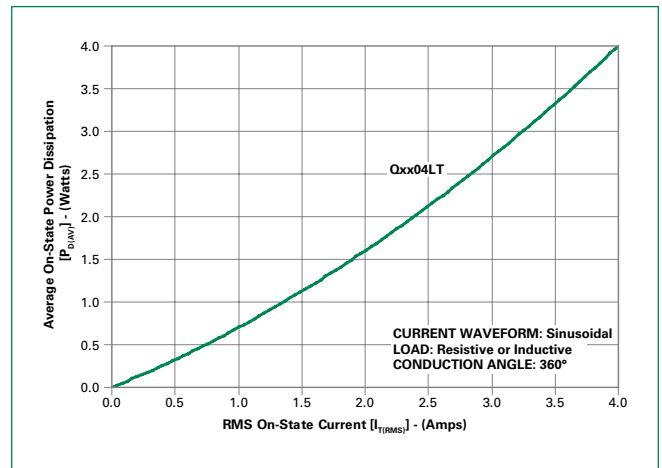

**Figure 5: Power Dissipation vs. RMS On-State Current (Typical) (6A to 15A)**

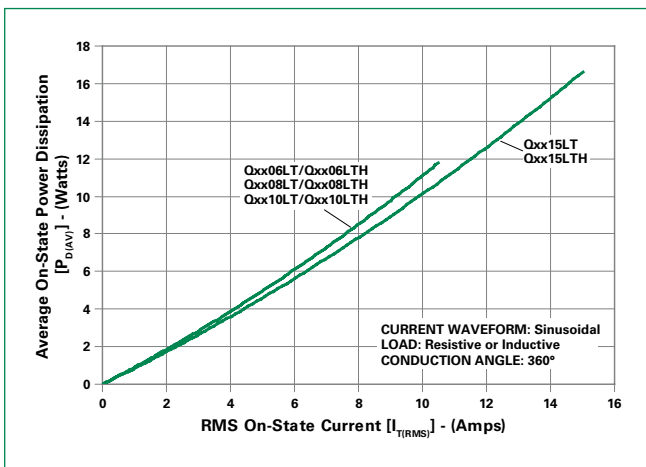

**Figure 6: Maximum Allowable Case Temperature vs. RMS On-State Current**

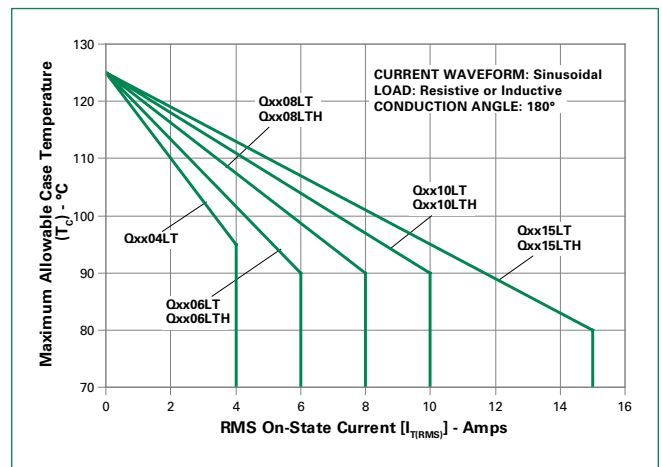

Figure 7: Surge Peak On-State Current vs. Number of Cycles



Note: xx = voltage

Figure 8: DIAC  $V_{BO}$  Change vs. Junction Temperature



Figure 9: Test Circuit



Figure 10: Test Circuit Waveform

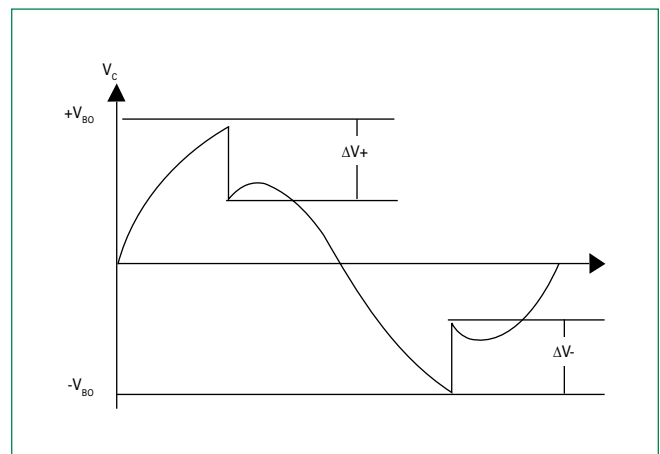

### Soldering Parameters

|  |                                    |                        |
|--|------------------------------------|------------------------|
| Reflow Condition                                       |                                    | Pb – Free assembly     |
| Pre Heat   | - Temperature Min ( $T_{s(min)}$ ) | 150°C                  |
|  | - Temperature Max ( $T_{s(max)}$ ) | 200°C                  |
|  | - Time (min to max) ( $t_s$ )      | 60 – 180 secs          |
| Average ramp up rate (Liquidus Temp ( $T_L$ ) to peak) |                                    | 5°C/second max         |
| $T_{s(max)}$ to $T_L$ - Ramp-up Rate                   |                                    | 5°C/second max         |
| Reflow   | - Temperature ( $T_L$ ) (Liquidus) | 217°C                  |
|  | - Temperature ( $t_L$ )            | 60 – 150 seconds       |
| Peak Temperature ( $T_p$ )                             |                                    | 260°C <sup>+0/-5</sup> |
| Time within 5°C of actual peak Temperature ( $t_p$ )   |                                    | 20 – 40 seconds        |
| Ramp-down Rate   |                                    | 5°C/second max         |
| Time 25°C to peak Temperature ( $T_p$ )                |                                    | 8 minutes Max.         |
| Do not exceed  |                                    | 280°C                  |



### Physical Specifications

|                        |   |
|------------------------|---|
| <b>Terminal Finish</b> | 1005 Matte Tin-plated   |
| <b>Body Material</b>   | UL Recognized epoxy meeting flammability classification 94v-0 |
| <b>Lead Material</b>   | Copper Alloy  |

### Design Considerations

Careful selection of the correct device for the application's operating parameters and environment will go a long way toward extending the operating life of the Thyristor. Good design practice should limit the maximum continuous current through the main terminals to 75% of the device rating. Other ways to ensure long life for a power discrete semiconductor are proper heat sinking and selection of voltage ratings for worst case conditions. Overheating, overvoltage (including dv/dt), and surge currents are the main killers of semiconductors. Correct mounting, soldering, and forming of the leads also help protect against component damage.

### Environmental Specifications

| Test                                     | Specifications and Conditions  |
|--|--|
| <b>High Temperature Voltage Blocking</b> | MIL-STD-750: Method 1040, Condition A Rated $V_{DRM}$ (VAC-peak), 125°C, 1008 hours  |
| <b>Temperature Cycling</b>               | MIL-STD-750: Method 1051 -40°C to 150°C, 15-minute dwell, 100 cycles                 |
| <b>Biased Temperature &amp; Humidity</b> | EIA/JEDEC: JESD22-A101 320VDC, 85°C, 85%RH, 1008 hours                               |
| <b>High Temp Storage</b>                 | MIL-STD-750: Method 1031 150°C, 1008 hours   |
| <b>Low-Temp Storage</b>                  | -40°C, 1008 hours  |
| <b>Thermal Shock</b>                     | MIL-STD-750: Method 1056 0°C to 100°C, 5-minute dwell, 10-second transfer, 10 cycles |
| <b>Autoclave (Pressure Cooker Test)</b>  | EIA/JEDEC: JESD22-A102 121°C, 100%RH, 2atm, 168 hours                                |
| <b>Resistance to Solder Heat</b>         | MIL-STD-750: Method 2031 260°C, 10 seconds   |
| <b>Solderability</b>                     | ANSI/J-STD-002, Category 3, Test A   |
| <b>Lead Bend</b>                         | MIL-STD-750: Method 2036, Condition E  |

**Dimensions — TO-220AB (L-Package) — Isolated Mounting Tab**

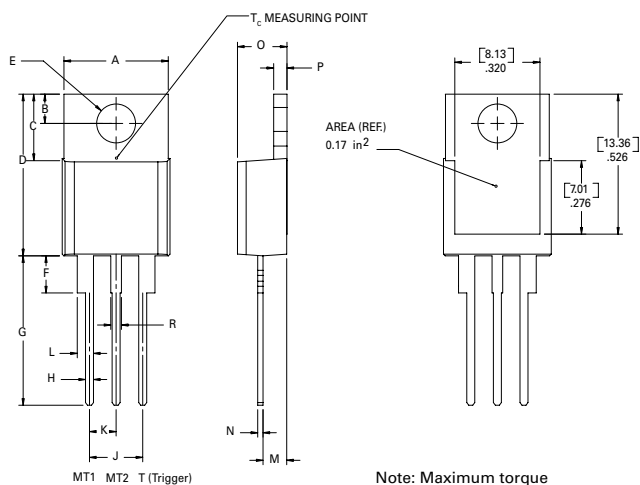

| Dimension | Inches |       | Millimeters |       |
|-----------|--------|-------|-------------|-------|
|           | Min    | Max   | Min         | Max   |
| A         | 0.380  | 0.420 | 9.65        | 10.67 |
| B         | 0.105  | 0.115 | 2.67        | 2.92  |
| C         | 0.230  | 0.250 | 5.84        | 6.35  |
| D         | 0.590  | 0.620 | 14.99       | 15.75 |
| E         | 0.142  | 0.147 | 3.61        | 3.73  |
| F         | 0.110  | 0.130 | 2.79        | 3.30  |
| G         | 0.540  | 0.575 | 13.72       | 14.61 |
| H         | 0.025  | 0.035 | 0.64        | 0.89  |
| J         | 0.195  | 0.205 | 4.95        | 5.21  |
| K         | 0.095  | 0.105 | 2.41        | 2.67  |
| L         | 0.060  | 0.075 | 1.52        | 1.91  |
| M         | 0.085  | 0.095 | 2.16        | 2.41  |
| N         | 0.018  | 0.024 | 0.46        | 0.61  |
| O         | 0.178  | 0.188 | 4.52        | 4.78  |
| P         | 0.045  | 0.060 | 1.14        | 1.52  |
| R         | 0.038  | 0.048 | 0.97        | 1.22  |

**Product Selector**

| Part Number | Voltage |      |      |       | Type                | Package |
|-------------|---------|------|------|-------|---------------------|---------|
|             | 400V    | 600V | 800V | 1000V |                     |         |
| Qxx04LT     | X       | X    |      |       | Quadrac             | TO-220L |
| Qxx06LT     | X       | X    |      |       | Quadrac             | TO-220L |
| Qxx06LTH    | X       | X    |      |       | Alternistor Quadrac | TO-220L |
| Qxx08LT     | X       | X    |      |       | Quadrac             | TO-220L |
| Qxx08LTH    | X       | X    |      |       | Alternistor Quadrac | TO-220L |
| Qxx10LT     | X       | X    |      |       | Quadrac             | TO-220L |
| Qxx10LTH    | X       | X    |      |       | Alternistor Quadrac | TO-220L |
| Qxx15LT     | X       | X    |      |       | Quadrac             | TO-220L |
| Qxx15LTH    | X       | X    |      |       | Alternistor Quadrac | TO-220L |

Note: xx = Voltage

**Packing Options**

| Part Number | Marking  | Weight | Packing Mode | Base Quantity     |
|-------------|----------|--------|--------------|-------------------|
| Qxx04LT     | Qxx04LT  | 2.2 g  | Bulk         | 500               |
| Qxx04LTTP   | Qxx04LT  | 2.2 g  | Tube         | 500 (50 per tube) |
| Qxx06LT     | Qxx06LT  | 2.2 g  | Bulk         | 500               |
| Qxx06LTTP   | Qxx06LT  | 2.2 g  | Tube         | 500 (50 per tube) |
| Qxx06LTH    | Qxx06LTH | 2.2 g  | Bulk         | 500               |
| Qxx06LTHTP  | Qxx06LTH | 2.2 g  | Tube         | 500 (50 per tube) |
| Qxx08LT     | Qxx08LT  | 2.2 g  | Bulk         | 500               |
| Qxx08LTTP   | Qxx08LT  | 2.2 g  | Tube         | 500 (50 per tube) |
| Qxx08LTH    | Qxx08LTH | 2.2 g  | Bulk         | 500               |
| Qxx08LTHTP  | Qxx08LTH | 2.2 g  | Tube         | 500 (50 per tube) |
| Qxx10LT     | Qxx10LT  | 2.2 g  | Bulk         | 500               |
| Qxx10LTTP   | Qxx10LT  | 2.2 g  | Tube         | 500 (50 per tube) |
| Qxx10LTH    | Qxx10LTH | 2.2 g  | Bulk         | 500               |
| Qxx10LTHTP  | Qxx10LTH | 2.2 g  | Tube         | 500 (50 per tube) |
| Qxx15LT     | Qxx15LT  | 2.2 g  | Bulk         | 500               |
| Qxx15LTTP   | Qxx15LT  | 2.2 g  | Tube         | 500 (50 per tube) |
| Qxx15LTH    | Qxx15LTH | 2.2 g  | Bulk         | 500               |
| Qxx15LTHTP  | Qxx15LTH | 2.2 g  | Tube         | 500 (50 per tube) |

Note: xx = Voltage

**Part Numbering System**



**Part Marking System**

TO-220 AB – (L Package)





Компания «Life Electronics» занимается поставками электронных компонентов импортного и отечественного производства от производителей и со складов крупных дистрибьюторов Европы, Америки и Азии.

С конца 2013 года компания активно расширяет линейку поставок компонентов по направлению коаксиальный кабель, кварцевые генераторы и конденсаторы (керамические, пленочные, электролитические), за счёт заключения дистрибьюторских договоров

Мы предлагаем:

- Конкурентоспособные цены и скидки постоянным клиентам.
- Специальные условия для постоянных клиентов.
- Подбор аналогов.
- Поставку компонентов в любых объемах, удовлетворяющих вашим потребностям.
- Приемлемые сроки поставки, возможна ускоренная поставка.
- Доставку товара в любую точку России и стран СНГ.
- Комплексную поставку.
- Работу по проектам и поставку образцов.
- Формирование склада под заказчика.
- Сертификаты соответствия на поставляемую продукцию (по желанию клиента).
- Тестирование поставляемой продукции.
- Поставку компонентов, требующих военную и космическую приемку.
- Входной контроль качества.
- Наличие сертификата ISO.

В составе нашей компании организован Конструкторский отдел, призванный помогать разработчикам, и инженерам.

Конструкторский отдел помогает осуществить:

- Регистрацию проекта у производителя компонентов.
- Техническую поддержку проекта.
- Защиту от снятия компонента с производства.
- Оценку стоимости проекта по компонентам.
- Изготовление тестовой платы монтаж и пусконаладочные работы.



Тел: +7 (812) 336 43 04 (многоканальный)  
Email: [org@lifeelectronics.ru](mailto:org@lifeelectronics.ru)