



## Features

- Functionally and pin compatible with CSPEMI606 (CM1420) and CSPEMI608 (CM1422) devices
- *OptiGuard*™ coated for improved reliability at assembly
- Six and eight channels of EMI filtering
- $\pm 15\text{kV}$  ESD protection on each channel (IEC 61000-4-2 Level 4, contact discharge)
- $\pm 30\text{kV}$  ESD protection on each channel (HBM)
- Better than 30dB of attenuation at 1GHz to 3GHz
- Chip Scale Package features extremely low lead inductance for optimum filter and ESD performance
- 15-bump, 2.960mm x 1.330mm footprint Chip Scale Package (CM1420)
- 20-bump, 4.000mm x 1.458mm footprint Chip Scale Package (CM1422)
- RoHS compliant (lead-free) finishing

## Applications

- LCD data lines in clamshell wireless handsets
- EMI filtering & ESD protection for high-speed I/O data ports
- Wireless handsets / cell phones
- Notebook computers
- PDAs / Handheld PCs
- EMI filtering for high-speed data lines

## Product Description

The CM1420 and CM1422 are EMI filter arrays with ESD protection, which integrate six and eight Pi-filters (C-R-C), respectively. The CM1420/22 has component values of 15pF-100 $\Omega$ -15pF. These devices include ESD protection diodes on every pin, which provide a very high level of protection for sensitive electronic components that may be subjected to electrostatic discharge (ESD). The ESD diodes connected to the filter ports safely dissipate ESD strikes of  $\pm 15\text{kV}$ , well beyond the maximum requirement of the IEC 61000-4-2 international standard. Using the MIL-STD-883 (Method 3015) specification for Human Body Model (HBM) ESD, the pins are protected for contact discharges at greater than  $\pm 30\text{kV}$ .

This device is particularly well suited for portable electronics (e.g. wireless handsets, PDAs, notebook computers) because of its small package format and easy-to-use pin assignments. In particular, the CM1420/22 is ideal for EMI filtering and protecting data lines from ESD for the LCD display in clamshell handsets.

The CM1420 and CM1422 incorporate *OptiGuard*™ coating which results in improved reliability at assembly. The CM1420 and CM1422 are available in space-saving, low-profile chip-scale packages with RoHS compliant lead-free finishing.

### Block Diagram

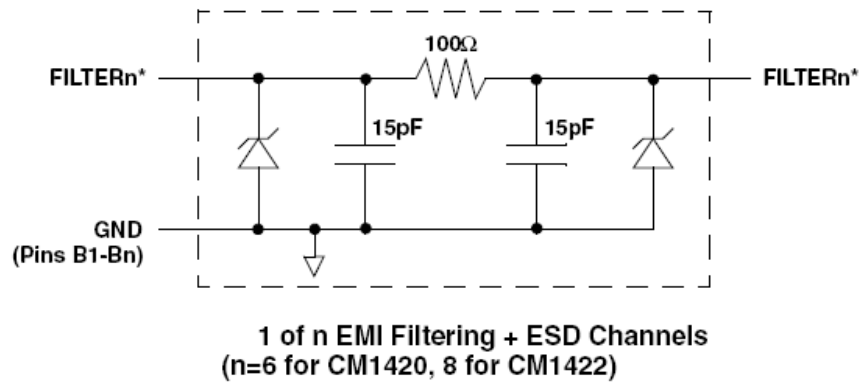

\* See Package/Pinout Diagram for expanded pin information.

### PACKAGE / PINOUT DIAGRAMS

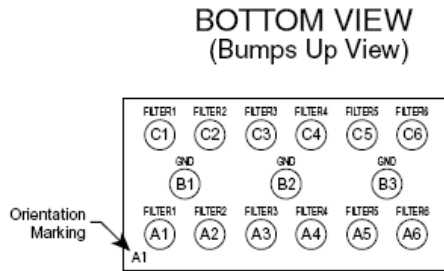
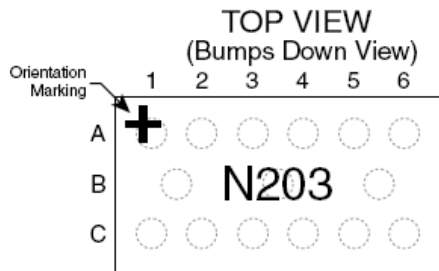

CM1420 CSP Package

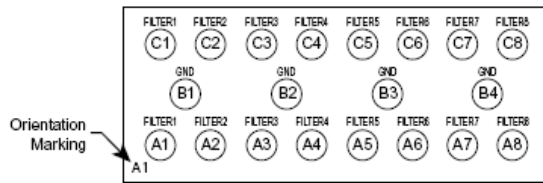
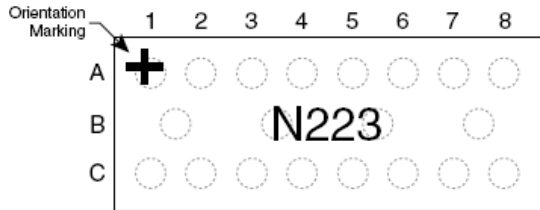

CM1422 CSP Package

Notes:  
1) These drawings are not to scale.

# CM1420-22

## PIN DESCRIPTIONS

CM1420	CM1422	NAME	DESCRIPTION	CM1420	CM1422	NAME	DESCRIPTION
PIN(s)	PIN(s)	NAME	DESCRIPTION	PIN(s)	PIN(s)	NAME	DESCRIPTION
A1	A1	FILTER1	Filter Channel 1	C1	C1	FILTER1	Filter Channel 1
A2	A2	FILTER2	Filter Channel 2	C2	C2	FILTER2	Filter Channel 2
A3	A3	FILTER3	Filter Channel 3	C3	C3	FILTER3	Filter Channel 3
A4	A4	FILTER4	Filter Channel 4	C4	C4	FILTER4	Filter Channel 4
A5	A5	FILTER5	Filter Channel 5	C5	C5	FILTER5	Filter Channel 5
A6	A6	FILTER6	Filter Channel 6	C6	C6	FILTER6	Filter Channel 6
-	A7	FILTER7	Filter Channel 7	-	C7	FILTER7	Filter Channel 7
-	A8	FILTER8	Filter Channel 8	-	C8	FILTER8	Filter Channel 8
B1-B3	B1-B4	GND	Device Ground				

## Ordering Information

### PART NUMBERING INFORMATION

Bumps	Package	Ordering Part Number <sup>1</sup>	Part Marking
15	CSP	CM1420-03CP	N203
20	CSP	CM1422-03CP	N223

Note 1: Parts are shipped in Tape & Reel form unless otherwise specified.

## Specifications

### ABSOLUTE MAXIMUM RATINGS

PARAMETER	RATING	UNITS
Storage Temperature Range	-65 to +150	°C
DC Power per Resistor	100	mW
DC Package Power Rating	500	mW

### STANDARD OPERATING CONDITIONS

PARAMETER	RATING	UNITS
Operating Temperature Range	-40 to +85	°C

**ELECTRICAL OPERATING CHARACTERISTICS<sup>1</sup>**

SYMBOL	PARAMETER	CONDITIONS	MIN	TYP	MAX	UNITS
R	Resistance		80	100	120	Ω
C	Capacitance	At 2.5V DC, 1MHz, 30mV AC	12	15	18	pF
V <sub>DIODE</sub>	Diode Standoff Voltage	I <sub>DIODE</sub> =10μA		6.0		V
I <sub>LEAK</sub>	Diode Leakage Current (reverse bias)	V <sub>DIODE</sub> = 3.3V		100	200	nA
V <sub>SIG</sub>	Signal Voltage Positive Clamp Negative Clamp	I <sub>LOAD</sub> = 10mA; Note 3	5.6 -1.5	6.8 -0.8	9.0 -0.4	V V
V <sub>ESD</sub>	In-system ESD Withstand Voltage a) Human Body Model, MIL-STD-883, Method 3015 b) Contact Discharge per IEC 61000-4-2 Level 4	Note 2	±30 ±15			kV kV
R <sub>DYN</sub>	Dynamic Resistance Positive Negative			2.30 0.90		Ω Ω
f <sub>c</sub>	Cut-off Frequency Z <sub>SOURCE</sub> =50Ω, Z <sub>LOAD</sub> =50Ω	R=100Ω, C=15pF		120		MHz

Note 1: T<sub>A</sub>=25°C unless otherwise specified.

Note 2: ESD applied to input and output pins with respect to GND, one at a time.

Note 3: Clamping voltage is measured at the opposite side of the EMI filter to the ESD pin. For example, if ESD is applied to Pin A1, then clamping voltage is measured at Pin C1.

## Performance Information

Typical Filter Performance ( $T_A=25^\circ\text{C}$ , DC Bias=0V, 50 Ohm Environment)

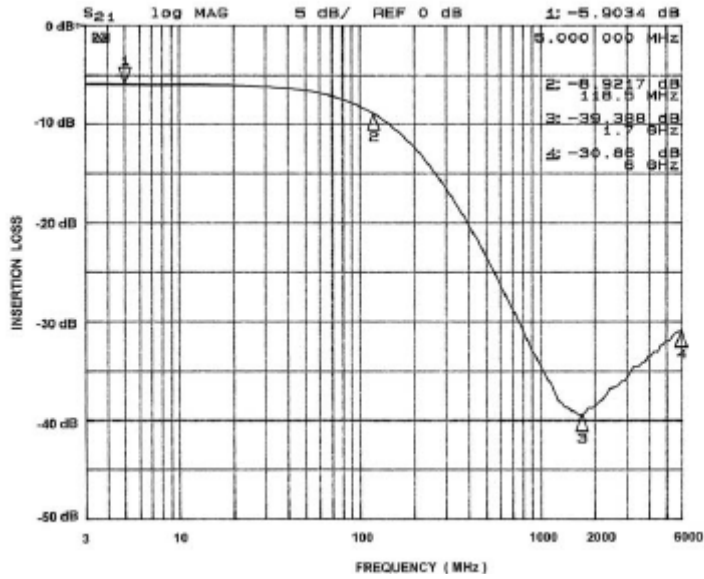

Figure 1. Insertion Loss VS. Frequency (A1-C1 to GND B1)

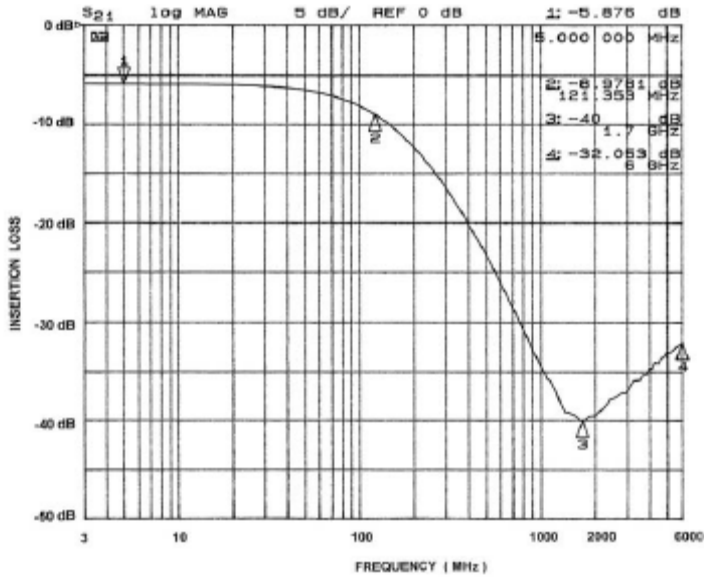

Figure 2. Insertion Loss VS. Frequency (A2-C2 to GND B1)

## Performance Information (cont'd)

Typical Filter Performance ( $T_A=25^\circ\text{C}$ , DC Bias=0V, 50 Ohm Environment)

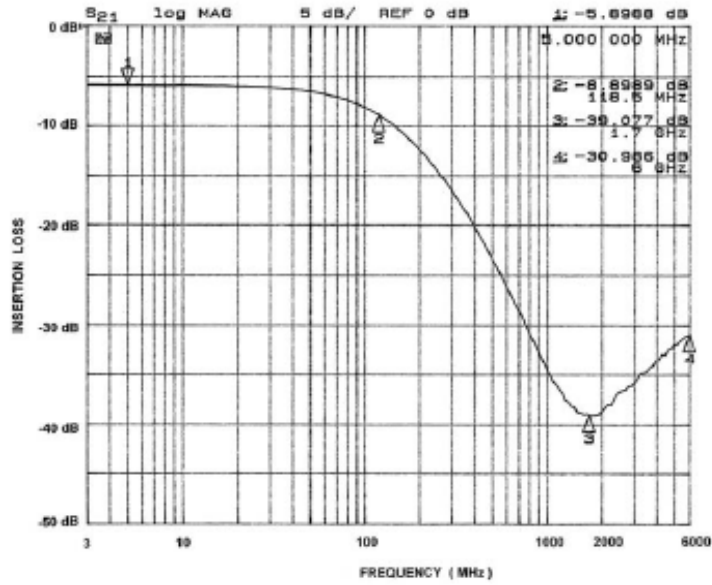

Figure 3. Insertion Loss VS. Frequency (A3-C3 to GND B2)

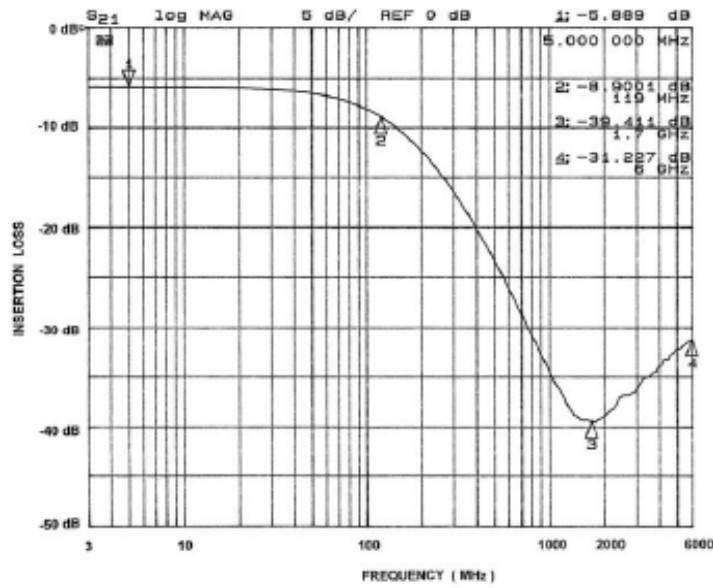

Figure 4. Insertion Loss VS. Frequency (A4-C4 to GND B2)

## Performance Information (cont'd)

Typical Filter Performance ( $T_A=25^\circ\text{C}$ , DC Bias=0V, 50 Ohm Environment)

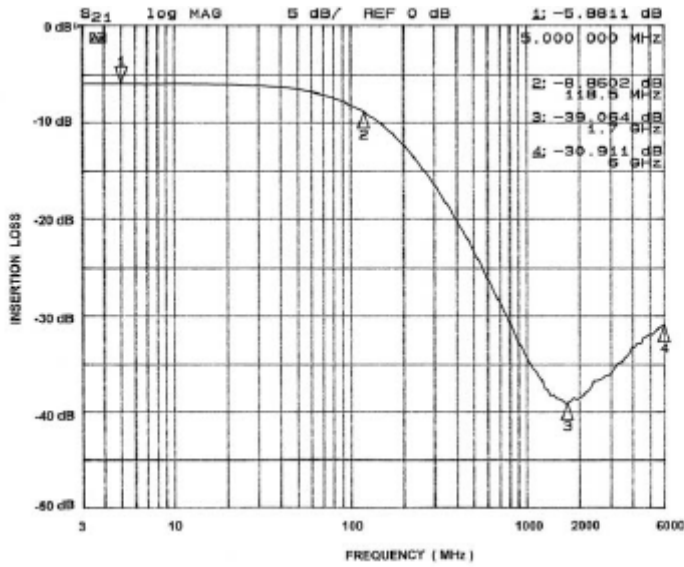

Figure 5. Insertion Loss VS. Frequency (A5-C5 to GND B3)

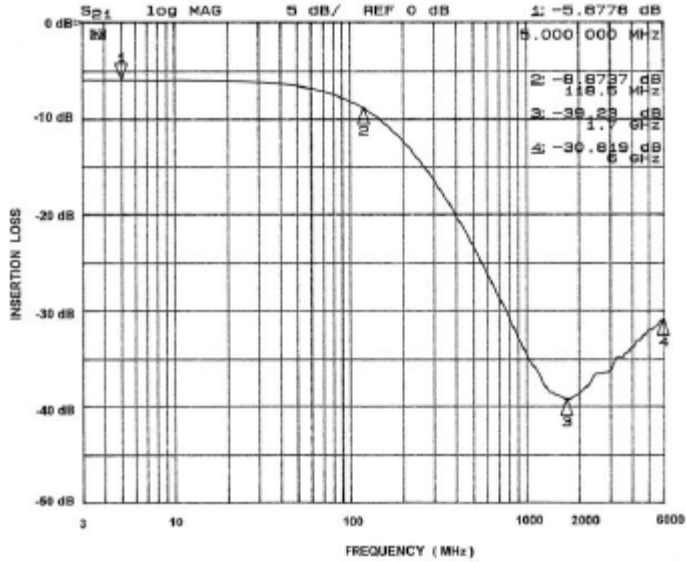

Figure 6. Insertion Loss VS. Frequency (A6-C6 to GND B3)



Performance Information (cont'd)

Typical Filter Performance ( $T_A=25^\circ\text{C}$ , DC Bias=0V, 50 Ohm Environment)

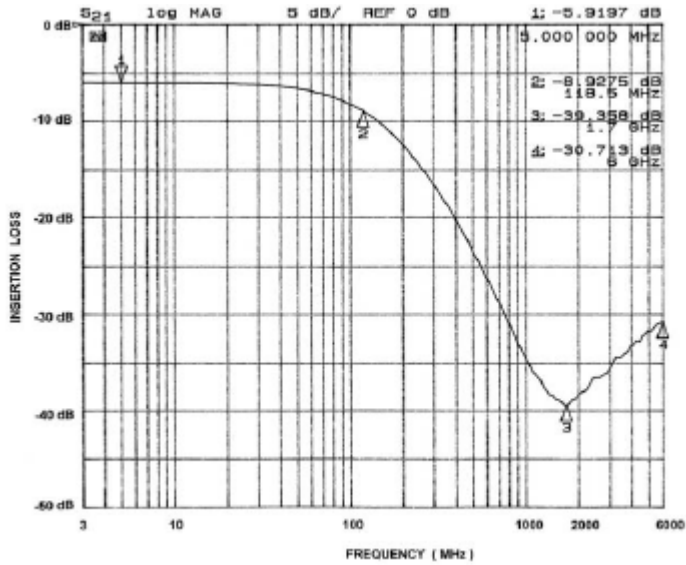

Figure 7. Insertion Loss VS. Frequency (A7-C7 to GND B4, CM1422 Only)

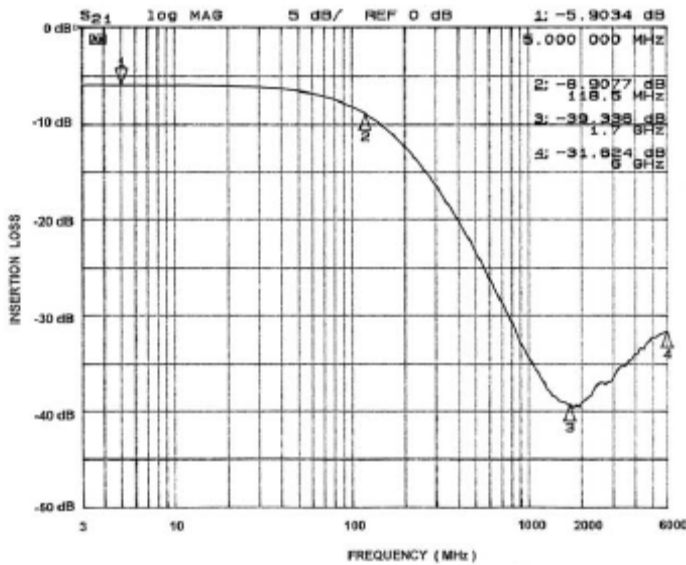
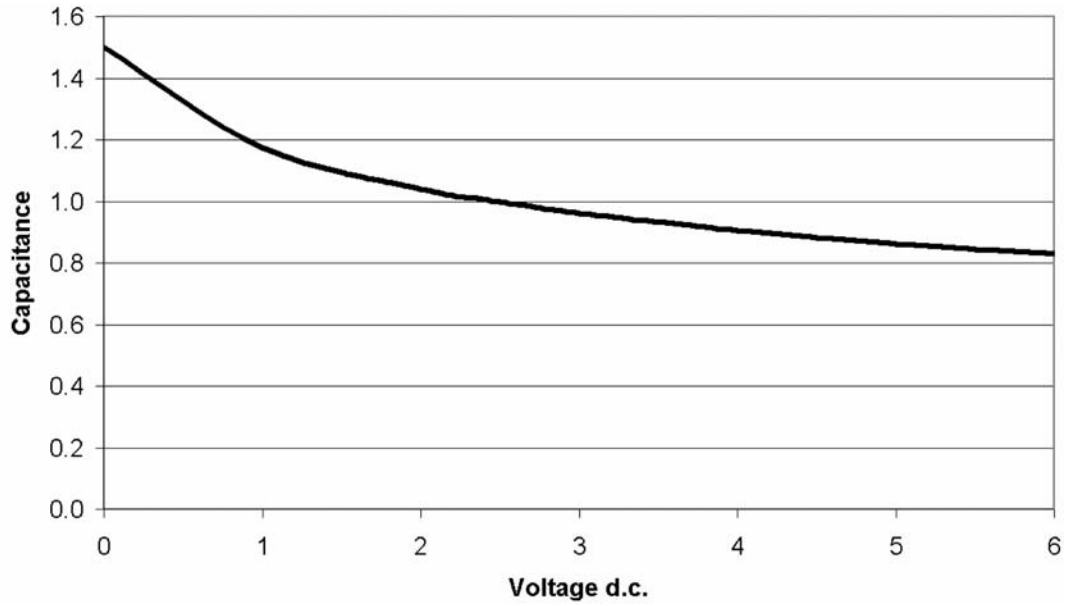

Figure 8. Insertion Loss VS. Frequency (A8-C8 to GND B4, CM1422 Only)

**Performance Information (cont'd)**



**Figure 9. Filter Capacitance vs. Input Voltage over Temperature (normalized to capacitance at 2.5VDC and 25°C)**

## Application Information

PARAMETER	VALUE
Pad Size on PCB	0.240mm
Pad Shape	Round
Pad Definition	Non-Solder Mask defined pads
Solder Mask Opening	0.290mm Round
Solder Stencil Thickness	0.125mm - 0.150mm
Solder Stencil Aperture Opening (laser cut, 5% tapered walls)	0.300mm Round
Solder Flux Ratio	50/50 by volume
Solder Paste Type	No Clean
Pad Protective Finish	OSP (Entek Cu Plus 106A)
Tolerance — Edge To Corner Ball	$\pm 50\mu\text{m}$
Solder Ball Side Coplanarity	$\pm 20\mu\text{m}$
Maximum Dwell Time Above Liquidous	60 seconds
Maximum Soldering Temperature for Lead-free Devices using a Lead-free Solder Paste	260°C

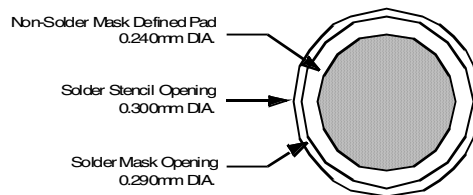

Figure 5. Recommended Non-Solder Mask Defined Pad Illustration

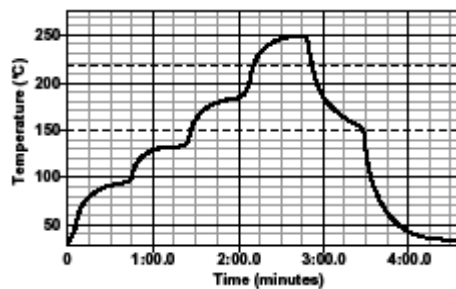

Figure 6. Lead-free (SnAgCu) Solder Ball Reflow Profile

## Mechanical Details

The CM1420/22 is offered in 15-bump and 20-bump custom Chip Scale Packages (CSP). Dimensions for each of these devices are presented in the following pages.

### CM1420 Mechanical Specifications

The package dimensions for the CM1420 are presented below.

PACKAGE DIMENSIONS						
Package	Custom CSP					
Bumps	15					
Dim	Millimeters			Inches		
	Min	Nom	Max	Min	Nom	Max
A1	2.915	2.960	3.005	0.1148	0.1165	0.1183
A2	1.285	1.330	1.375	0.0506	0.0524	0.0541
B1	0.495	0.500	0.505	0.0195	0.0197	0.0199
B2	0.245	0.250	0.255	0.0096	0.0098	0.0100
B3	0.430	0.435	0.440	0.0169	0.0171	0.0173
B4	0.430	0.435	0.440	0.0169	0.0171	0.0173
C1	0.180	0.230	0.280	0.0071	0.0091	0.0110
C2	0.180	0.230	0.280	0.0071	0.0091	0.0110
D1	0.575	0.644	0.714	0.0226	0.0254	0.0281
D2	0.368	0.419	0.470	0.0145	0.0165	0.0185
# per tape and reel	3500 pieces					
Controlling dimension: millimeters						

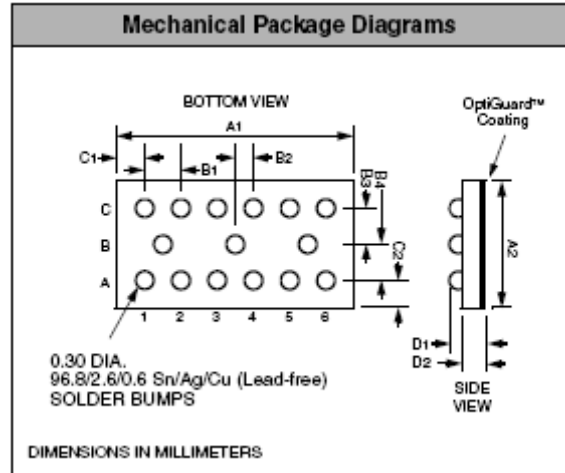

**Package Dimensions for  
CM1420 Chip Scale Package**

## Mechanical Details (cont'd)

### CM1422 Mechanical Specifications

The package dimensions for the CM1422 are presented below.

PACKAGE DIMENSIONS						
Package	Custom CSP					
Bumps	20					
Dim	Millimeters			Inches		
	Min	Nom	Max	Min	Nom	Max
A1	3.955	4.000	4.045	0.1557	0.1575	0.1593
A2	1.413	1.458	1.503	0.0556	0.0574	0.0592
B1	0.495	0.500	0.505	0.0195	0.0197	0.0199
B2	0.245	0.250	0.255	0.0096	0.0098	0.0100
B3	0.430	0.435	0.440	0.0169	0.0171	0.0173
B4	0.430	0.435	0.440	0.0169	0.0171	0.0173
C1	0.200	0.250	0.300	0.0079	0.0098	0.0118
C2	0.244	0.294	0.344	0.0096	0.0116	0.0135
D1	0.575	0.644	0.714	0.0226	0.0254	0.0281
D2	0.368	0.419	0.470	0.0145	0.0165	0.0185
# per tape and reel	3500 pieces					
Controlling dimension: millimeters						

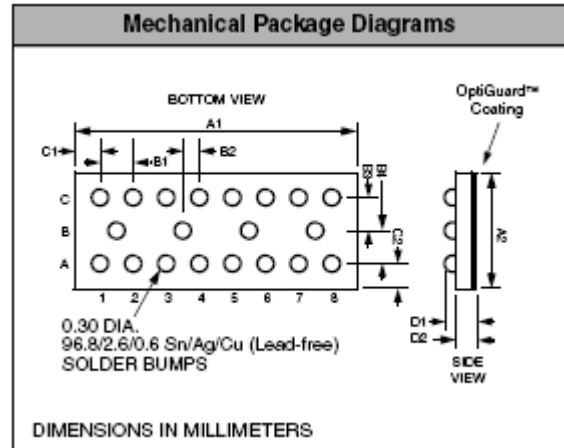

**Package Dimensions for  
CM1422 Chip Scale Package**

**CSP Tape and Reel Specifications**

PART NUMBER	CHIP SIZE (mm)	POCKET SIZE (mm) $B_0 \times A_0 \times K_0$	TAPE WIDTH W	REEL DIAMETER	QTY PER REEL	$P_0$	$P_1$
CM1420	2.96 X 1.33 X 0.644	3.10 X 1.45 X 0.74	8mm	178mm (7")	3500	4mm	4mm
CM1422	4.00 X 1.46 X 0.644	4.11 X 1.57 X 0.76	8mm	178mm (7")	3500	4mm	4mm

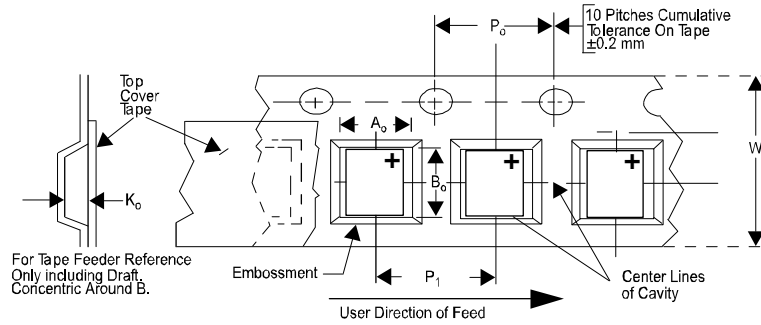

**Figure 12. Tape and Reel Mechanical Data**

ON Semiconductor and  are registered trademarks of Semiconductor Components Industries, LLC (SCILLC). SCILLC reserves the right to make changes without further notice to any products herein. SCILLC makes no warranty, representation or guarantee regarding the suitability of its products for any particular purpose, nor does SCILLC assume any liability arising out of the application or use of any product or circuit, and specifically disclaims any and all liability, including without limitation special, consequential or incidental damages. "Typical" parameters which may be provided in SCILLC data sheets and/or specifications can and do vary in different applications and actual performance may vary over time. All operating parameters, including "Typicals" must be validated for each customer application by customer's technical experts. SCILLC does not convey any license under its patent rights nor the rights of others. SCILLC products are not designed, intended, or authorized for use as components in systems intended for surgical implant into the body, or other applications intended to support or sustain life, or for any other application in which the failure of the SCILLC product could create a situation where personal injury or death may occur. Should Buyer purchase or use SCILLC products for any such unintended or unauthorized application, Buyer shall indemnify and hold SCILLC and its officers, employees, subsidiaries, affiliates, and distributors harmless against all claims, costs, damages, and expenses, and reasonable attorney fees arising out of, directly or indirectly, any claim of personal injury or death associated with such unintended or unauthorized use, even if such claim alleges that SCILLC was negligent regarding the design or manufacture of the part. SCILLC is an Equal Opportunity/Affirmative Action Employer. This literature is subject to all applicable copyright laws and is not for resale in any manner.

## PUBLICATION ORDERING INFORMATION

### LITERATURE FULFILLMENT:

Literature Distribution Center for ON Semiconductor  
P.O. Box 5163, Denver, Colorado 80217 USA  
**Phone:** 303-675-2175 or 800-344-3860 Toll Free USA/Canada  
**Fax:** 303-675-2176 or 800-344-3867 Toll Free USA/Canada  
**Email:** [orderlit@onsemi.com](mailto:orderlit@onsemi.com)

**N. American Technical Support:** 800-282-9855  
Toll Free USA/Canada  
**Europe, Middle East and Africa Technical Support:**  
Phone: 421 33 790 2910  
**Japan Customer Focus Center**  
Phone: 81-3-5773-3850

ON Semiconductor Website: [www.onsemi.com](http://www.onsemi.com)

Order Literature: <http://www.onsemi.com/orderlit>

For additional information, please contact your local Sales Representative

Компания «Life Electronics» занимается поставками электронных компонентов импортного и отечественного производства от производителей и со складов крупных дистрибьюторов Европы, Америки и Азии.

С конца 2013 года компания активно расширяет линейку поставок компонентов по направлению коаксиальный кабель, кварцевые генераторы и конденсаторы (керамические, пленочные, электролитические), за счёт заключения дистрибьюторских договоров

Мы предлагаем:

- Конкурентоспособные цены и скидки постоянным клиентам.
- Специальные условия для постоянных клиентов.
- Подбор аналогов.
- Поставку компонентов в любых объемах, удовлетворяющих вашим потребностям.
- Приемлемые сроки поставки, возможна ускоренная поставка.
- Доставку товара в любую точку России и стран СНГ.
- Комплексную поставку.
- Работу по проектам и поставку образцов.
- Формирование склада под заказчика.
- Сертификаты соответствия на поставляемую продукцию (по желанию клиента).
- Тестирование поставляемой продукции.
- Поставку компонентов, требующих военную и космическую приемку.
- Входной контроль качества.
- Наличие сертификата ISO.

В составе нашей компании организован Конструкторский отдел, призванный помогать разработчикам, и инженерам.

Конструкторский отдел помогает осуществить:

- Регистрацию проекта у производителя компонентов.
- Техническую поддержку проекта.
- Защиту от снятия компонента с производства.
- Оценку стоимости проекта по компонентам.
- Изготовление тестовой платы монтаж и пусконаладочные работы.

