

E3Z-LS

Reliable Detection of Glossy, Uneven Objects Regardless of Background or Color.

- Switching between background and foreground suppression (BGS/ FGS) enables detecting a variety of objects under various background/foreground conditions.
- Unique algorithm minimizes external interference from inverter fluorescent lighting.
- Minimal differential travel to enable detecting small steps.
- Provides a high degree of protection (IP67), mutual interference prevention, and EN standard compliance.



Be sure to read *Safety Precautions* on page 8.

Ordering Information

Sensors (Refer to *Dimensions* on page 10.)

Red light

| Sensing method | Appearance | Connection method | Sensing distance (white paper) | Model | |
|-------------------|------------|------------------------|--------------------------------|----------------|-------------|
| | | | | NPN output | PNP output |
| Distance-settable | | Pre-wired (2 m) *1 | | E3Z-LS61 2M *2 | E3Z-LS81 2M |
| | | Connector (M8, 4 pins) | | E3Z-LS66 | E3Z-LS86 |
| | | Pre-wired (2 m) *1 | | E3Z-LS63 2M | E3Z-LS83 2M |
| | | Connector (M8, 4 pins) | | E3Z-LS68 | E3Z-LS88 |

*1. Models with a 0.5-m cable are available. When ordering, specify the cable length by adding the code "0.5M" to the model number (e.g., E3Z-LS61 0.5M).

*2. The following table shows the model numbers of e-CON Pre-wired Connectors that are available. The Ratings and Specifications are the same as those for the E3Z-LS61.

| Cable length | Model |
|--------------|--------------------|
| 0.3 m | E3Z-LS61-ECON 0.3M |
| 0.5 m | E3Z-LS61-ECON 0.5M |
| 2 m | E3Z-LS61-ECON 2M |

Accessories (Order Separately)

Mounting Brackets

Sensor I/O Connectors (Refer to *Dimensions* on XS3)

| Cable specification | Appearance | Type of cable | Model |
|---------------------|------------|---------------|-----------------|
| Standard M8 cable | | 2 m | XS3F-M421-402-A |
| | | 5 m | XS3F-M421-405-A |
| | | 2 m | XS3F-M422-402-A |
| | | 5 m | XS3F-M422-405-A |

Ratings and Specifications

| Sensing method | | Distance-settable | | | |
|---|------------|---|------------------------|---|------------------------|
| Model | NPN output | E3Z-LS61 | E3Z-LS66 | E3Z-LS63 | E3Z-LS68 |
| Item | PNP output | E3Z-LS81 | E3Z-LS86 | E3Z-LS83 | E3Z-LS88 |
| Sensing distance | BGS | White or black paper (100 × 100 mm): 20 mm to set distance | | 2 mm to set distance (80 mm max.) | |
| | FGS | White paper (100 × 100 mm): Set distance to 200 mm min. Black paper (100 × 100 mm): Set distance to 160 mm min. | | ----- | |
| Setting range | | White paper (100 × 100 mm): 40 to 200 mm Black paper (100 × 100 mm): 40 to 160 mm | | White paper (100 × 100 mm): 20 to 80 mm | |
| Differential travel | | 10% of set distance max. (Refer to <i>Differential Travel vs. Sensing Distance</i> on page 4.) | | 2% of set distance max. | |
| Reflectivity characteristic (black/white error) | | 10% of set distance max. | | 5% of set distance max. | |
| Light source (wavelength) | | Red LED (680 nm) | | Red LED (650 nm) | |
| Power supply voltage | | 12 to 24 VDC ±10%, ripple (p-p): 10% max. | | | |
| Current consumption | | 30 mA max. | | | |
| Control output | | Load power supply voltage: 26.4 VDC max., Load current: 100 mA max. (residual voltage 1 V max.), Open collector output (NPN or PNP depending on model) Light-ON/Dark-ON switch selectable | | | |
| BGS/FGS selection | | BGS: Open or connected to GND FGS: Connected to Vcc | | BGS: Open or connected to GND | |
| Protection circuits | | Reversed power supply polarity protection, Output short-circuit protection, Mutual interference prevention | | | |
| Response time | | Operate or reset: 1 ms max. | | | |
| Distance setting | | 5-turn endless adjuster | | | |
| Ambient illumination (Receiver side) | | Incandescent lamp: 3,000 lx max.; Sunlight: 10,000 lx max. | | | |
| Ambient temperature range | | Operating: -25 to 55°C, Storage: -40 to 70°C (with no icing or condensation) | | | |
| Ambient humidity range | | Operating: 35% to 85%, Storage: 35% to 95% (with no condensation) | | | |
| Insulation resistance | | 20 MΩ min. at 500 VDC | | | |
| Dielectric strength | | 1,000 VAC at 50/60 Hz for 1 minute | | | |
| Vibration resistance | | Destruction: 10 to 55 Hz, 1.5-mm double amplitude for 2 hours each in X, Y, and Z directions | | | |
| Shock resistance | | Destruction: 500 m/s ² for 3 times each in X, Y, and Z directions | | | |
| Degree of protection | | IP67 (IEC 60529) | | | |
| Connection method | | Pre-wired (standard lengths: 2 m and 0.5 m) | Connector (M8, 4 pins) | Pre-wired (standard lengths: 2 m and 0.5 m) | Connector (M8, 4 pins) |
| Indicators | | Operation indicator (orange), Stability indicator (green) | | | |
| Weight (packed state) | | Pre-wired Sensors, 2 m: Approx. 65 g | Approx. 20 g | Pre-wired Sensors, 2 m: Approx. 65 g | Approx. 20 g |
| Material | Case | PBT (polybutylene terephthalate) | | | |
| | Lens | Modified polyarylate resin | | | |
| Accessories | | Instruction manual (Mounting Brackets must be ordered separately.) | | | |

Engineering Data

Operating Range

E3Z-LS□1/LS□6
BGS

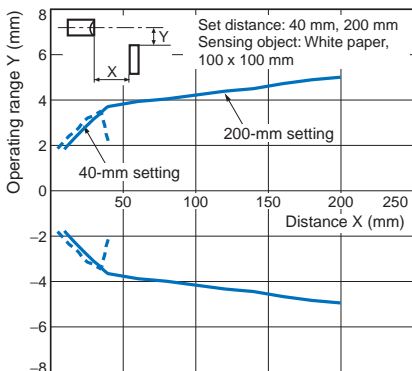

FGS

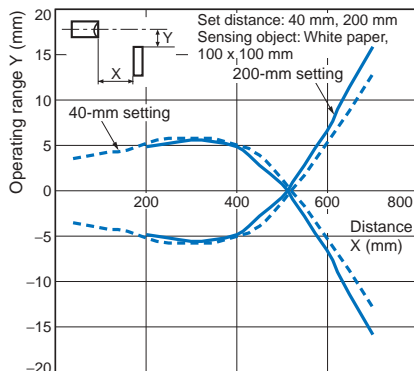

E3Z-LS□3/LS□8

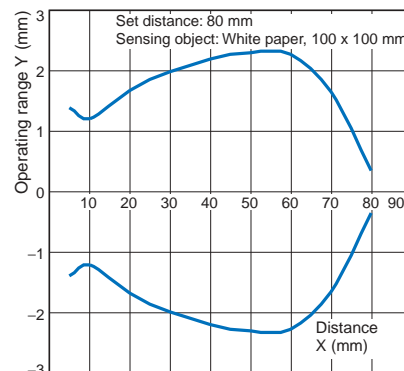

Spot Diameter vs. Sensing Distance

E3Z-LS□1/LS□6

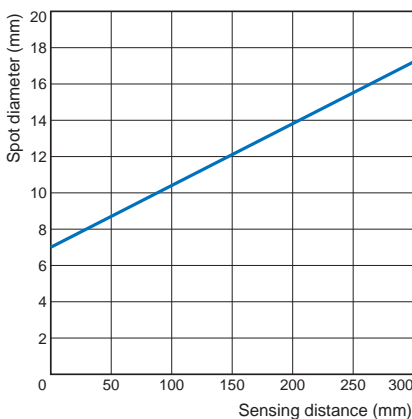

E3Z-LS□3/LS□8

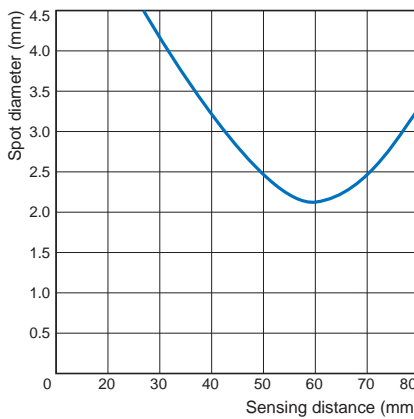

Close-range Characteristics

E3Z-LS□1/LS□6

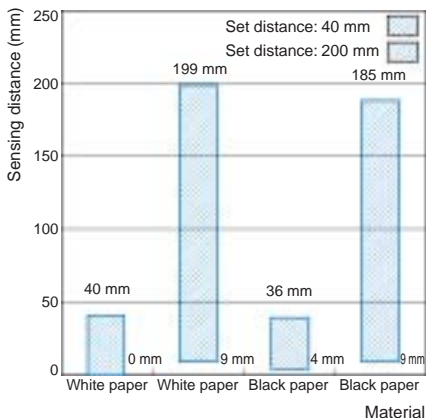

E3Z-LS□3/LS□8

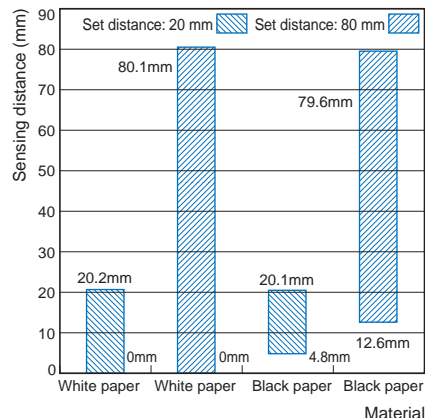

Differential Travel vs. Sensing Distance

E3Z-LS□1/LS□6

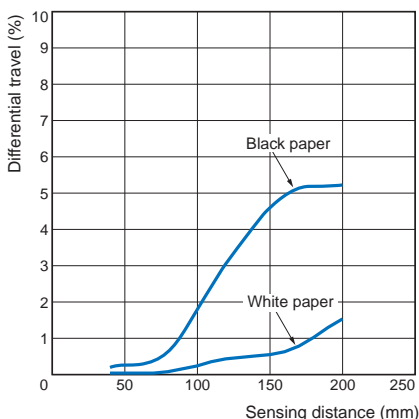

E3Z-LS□3/LS□8

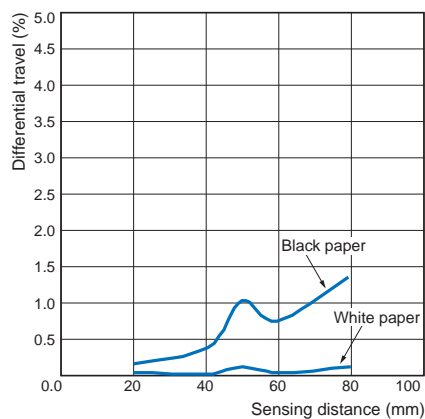

Sensing Object Angle Characteristics

E3Z-LS□1/LS□6

Vertical

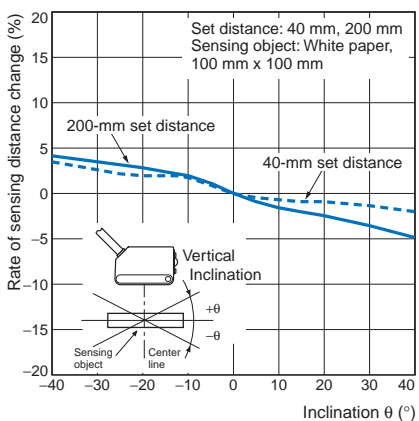

Horizontal

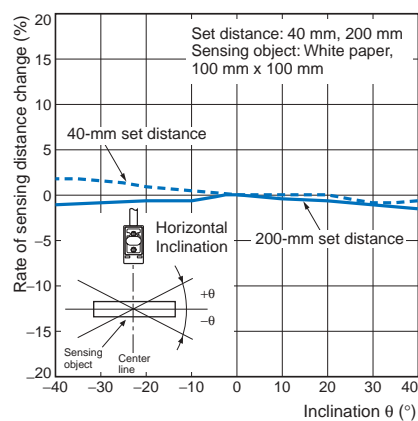

E3Z-LS□3/LS□8

Vertical

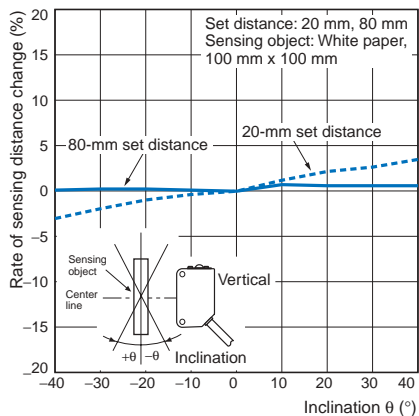

Horizontal

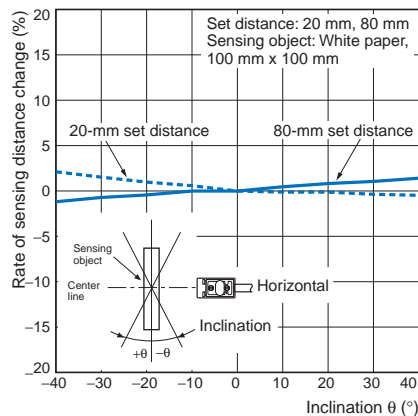

FGS Mode Set Distance

E3Z-LS□1/LS□6

White Paper

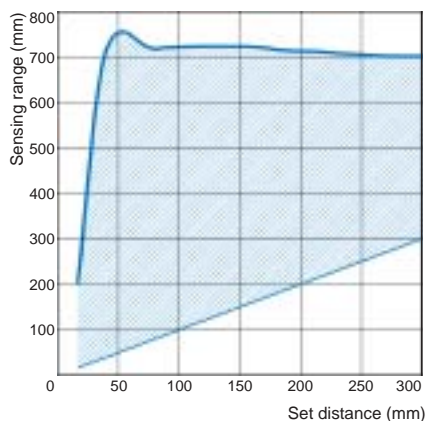

Black Paper

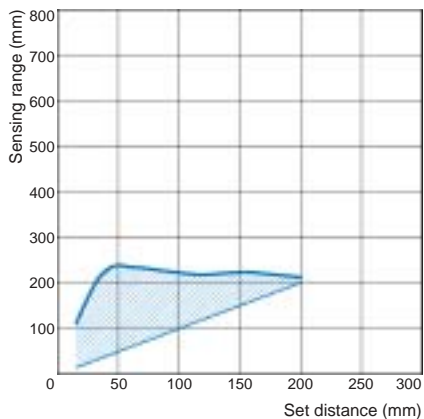

Sensing Distance vs. Sensing Object Material

E3Z-LS□1/LS□6

Set Distance of 40 mm using White Paper

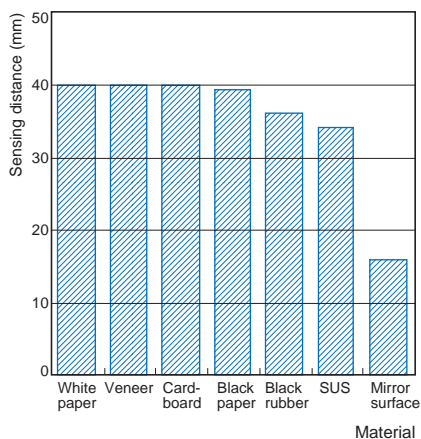

Set Distance of 200 mm using White Paper

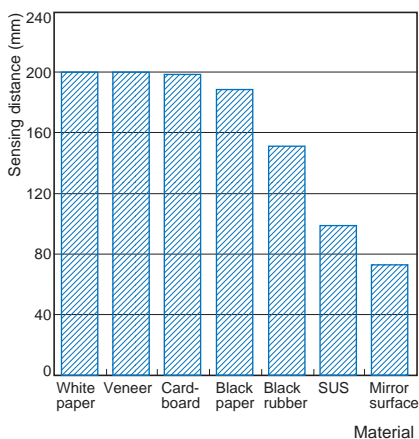

E3Z-LS□3/LS□8

Set Distance of 20 mm using White Paper

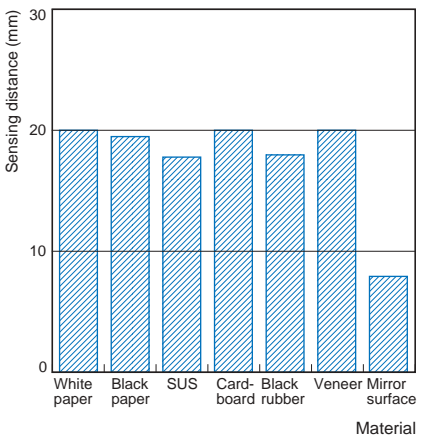

Set Distance of 80 mm using White Paper

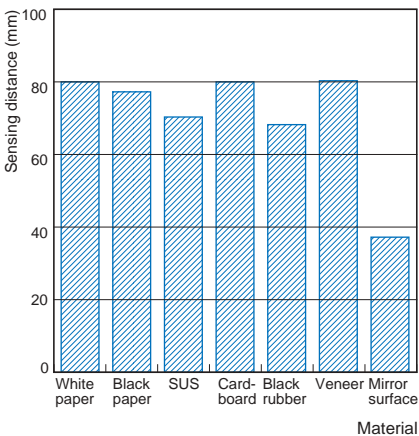

I/O Circuit Diagrams

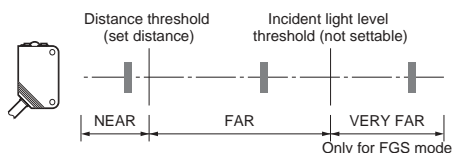

Note: The VERY FAR region is supported only for FGS.
The incident light level threshold is fixed and cannot be set.

NPN Output

| Model | Operation mode | Timing charts | Operation selector | BGS/FGS selection method | Output circuit |
|--|----------------|---------------|--------------------|---|----------------|
| E3Z-LS61 E3Z-LS66 E3Z-LS63 E3Z-LS68 | Light-ON | | L side (LIGHT ON) | BGS: Either leave the pink wire (2) open or connect it to the blue wire (3). | |
| | Dark-ON | | D side (DARK ON) | | |
| E3Z-LS61 E3Z-LS66 | Light-ON | | L side (LIGHT ON) | FGS: Connect the pink wire (2) to the brown wire (1). | |
| | Dark-ON | | D side (DARK ON) | | |

PNP Output

| Model | Operation mode | Timing charts | Operation selector | BGS/FGS selection method | Output circuit |
|--|----------------|---------------|--------------------|--|----------------------------------|
| E3Z-LS81 E3Z-LS86 E3Z-LS83 E3Z-LS88 | Light-ON | | L side (LIGHT ON) | BGS: Either leave the pink wire (2) open or connect it to the blue wire (3). | <p>Connector Pin Arrangement</p> |
| | Dark-ON | | D side (DARK ON) | | |
| E3Z-LS81 E3Z-LS86 | Light-ON | | L side (LIGHT ON) | FGS: Connect the pink wire (2) to the brown wire (1). | |
| | Dark-ON | | D side (DARK ON) | | |

Plugs (Sensor I/O Connectors)

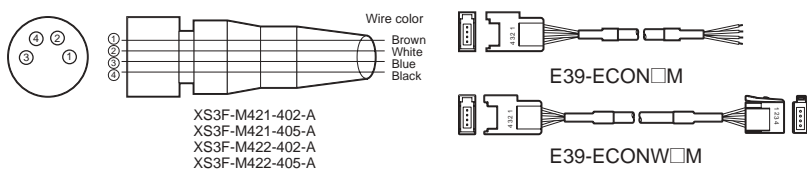

| Classification | Wire color | Connector pin No. | Application |
|----------------|------------|-------------------|--------------------|
| DC | Brown | 1 | Power supply (+V) |
| | White | 2 | BGS/FGS selection |
| | Blue | 3 | Power supply (0 V) |
| | Black | 4 | Output |

Nomenclature

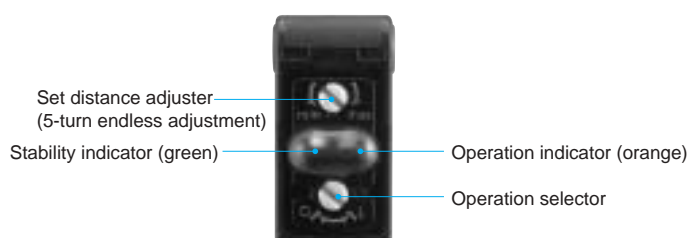

Safety Precautions

Refer to *Safety Precautions of the E3Z and Warranty and Limitations of Liability.*

⚠ WARNING

This product is not designed or rated for ensuring safety of persons either directly or indirectly. Do not use it for such purposes.



⚠ Caution

Do not connect an AC power supply to the Sensor. If AC power (100 VAC or more) is supplied to the Sensor, it may explode or burn.



Precautions for Safe Use

Be sure to abide by the following precautions for the safe operation of the Sensor.

● Wiring

Power Supply Voltage and Output Load Power Supply Voltage

Make sure that the power supply to the Sensor is within the rated voltage range. If a voltage exceeding the rated voltage range is supplied to the Sensor, it may explode or burn.

Load Short-circuiting

Do not short-circuit the load, otherwise the Sensor may be damaged.

Connection without Load

Do not connect the power supply to the Sensor with no load connected, otherwise the internal elements may explode or burn.

● Operating Environment

Do not use the Sensor in locations with explosive or flammable gas.

Precautions for Correct Use

Do not use the product in atmospheres or environments that exceed product ratings.

● Designing

Power Reset Time

The Sensor is ready to operate 100 ms after the Sensor is turned ON. If the load and Sensor are connected to independent power supplies respectively, be sure to turn ON the Sensor before supplying power to the load.

● Wiring

Avoiding Malfunctions

If using the Sensor with an inverter or servomotor, always ground the FG (frame ground) and G (ground) terminals, otherwise the Sensor may malfunction.

● Mounting

Mounting the Sensor

- If Sensors are mounted face-to-face, make sure that the optical axes are not in opposition to each other. Otherwise, mutual interference may result.
- Always install the Sensor carefully so that the aperture angle range of the Sensor will not cause it to be directly exposed to intensive light, such as sunlight, fluorescent light, or incandescent light.
- Do not strike the Photoelectric Sensor with a hammer or any other tool during the installation of the Sensor, or the Sensor will lose its water-resistive properties.
- Use M3 screws to mount the Sensor.
- When mounting the case, make sure that the tightening torque applied to each screw does not exceed 0.54 N·m.

M8 Connector

- Always turn OFF the power supply to the Sensor before connecting or disconnecting the metal connector.
 - Hold the connector cover to connect or disconnect it. If the XS3F is used, always tighten the connector cover by hand. Do not use pliers.
- If the connector is not connected securely, it may be disconnected by vibration or the proper degree of protection of the Sensor may not be maintained. The appropriate tightening torque is 0.3 to 0.4 N·m.
- If other commercially available connectors are used, follow the recommended connector application conditions and recommended tightening torque specifications.

Mounting Directions

- Make sure that the sensing side of the Sensor is parallel with the surface of the sensing objects. Normally, do not incline the Sensor towards the sensing object.

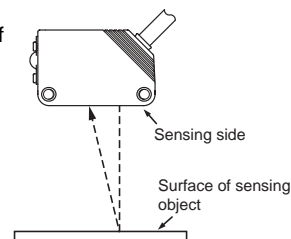

If the sensing object has a glossy surface, however, incline the Sensor by 5° to 10° as shown in the illustration, provided that the Sensor is not influenced by background objects.

- If there is a mirror-like object below the Sensor, the Sensor may not operate stably. Therefore, incline the Sensor or separate the Sensor from the mirror-like object as shown below.

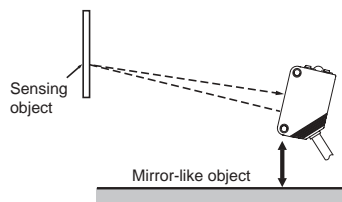
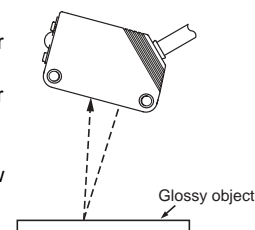

• Do not install the Sensor in the wrong direction. Refer to the following illustration.

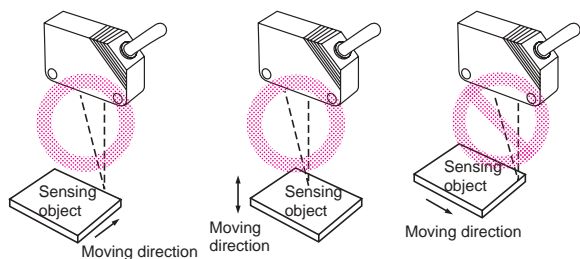

Install the Sensor as shown in the following illustration if each sensing object greatly differs in color or material.

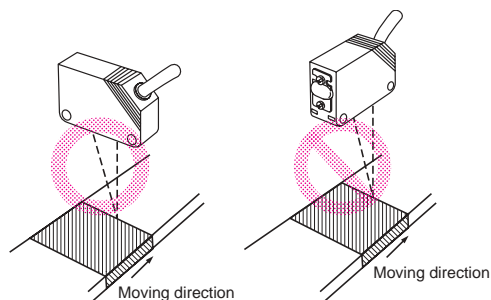

● Adjusting Indicator Operation

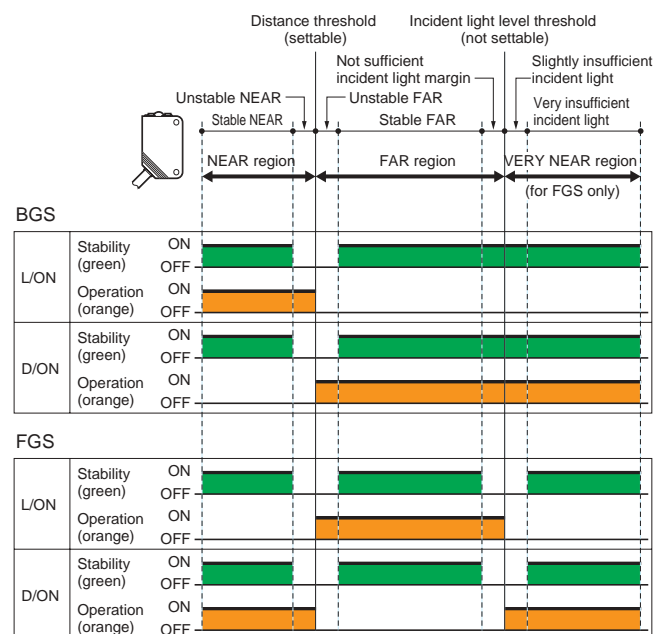

Note: 1. If the stability indicator is lit, the detection/no detection status is stable within the rated ambient operating temperature (-25 to 55°C).
 2. The VERY FAR region is supported only for FGS. The incident light threshold is fixed and cannot be set. The distance to the incident light threshold depends on the color and gloss of the sensing object's surface.

● Inspection and Maintenance

Cleaning

Never use paint thinners or other organic solvents to clean the surface of the product.

Dimensions

Pre-wired Models

E3Z-LS61
E3Z-LS81
E3Z-LS63
E3Z-LS83

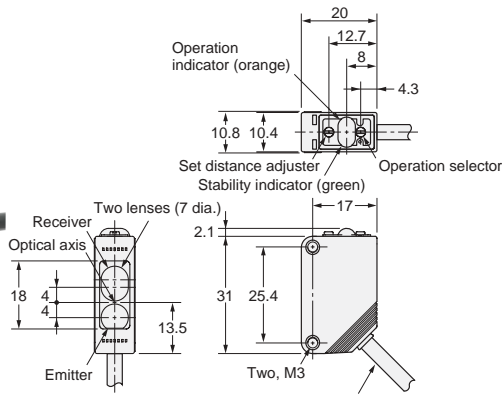

4-dia., vinyl-insulated round cable with 4 conductors (Conductor cross section: 0.2 mm² (AWG24); Insulator diameter: 1.1 mm), Standard length: 2 m/0.5 m

e-CON Pre-wired Connector

Connector: Model No. 37104-3122-000FL
Sumitomo 3M

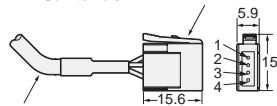

* 4-dia. vinyl-insulated round cable with 4 conductors
Standard lengths: 0.3 m, 0.5 m, and 2 m

Connector Models

E3Z-LS66
E3Z-LS86
E3Z-LS68
E3Z-LS88

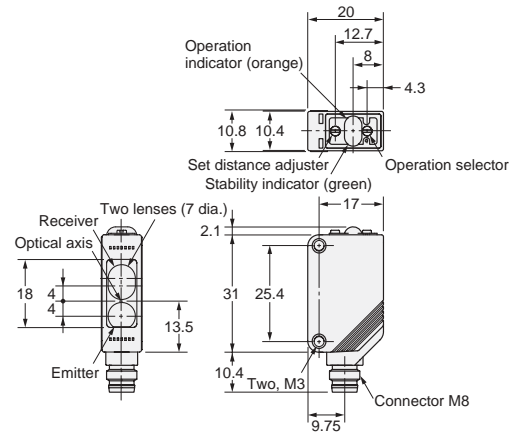

Read and Understand This Catalog

Please read and understand this catalog before purchasing the products. Please consult your OMRON representative if you have any questions or comments.

Warranty and Limitations of Liability

WARRANTY

OMRON's exclusive warranty is that the products are free from defects in materials and workmanship for a period of one year (or other period if specified) from date of sale by OMRON.

OMRON MAKES NO WARRANTY OR REPRESENTATION, EXPRESS OR IMPLIED, REGARDING NON-INFRINGEMENT, MERCHANTABILITY, OR FITNESS FOR PARTICULAR PURPOSE OF THE PRODUCTS. ANY BUYER OR USER ACKNOWLEDGES THAT THE BUYER OR USER ALONE HAS DETERMINED THAT THE PRODUCTS WILL SUITABLY MEET THE REQUIREMENTS OF THEIR INTENDED USE. OMRON DISCLAIMS ALL OTHER WARRANTIES, EXPRESS OR IMPLIED.

LIMITATIONS OF LIABILITY

OMRON SHALL NOT BE RESPONSIBLE FOR SPECIAL, INDIRECT, OR CONSEQUENTIAL DAMAGES, LOSS OF PROFITS OR COMMERCIAL LOSS IN ANY WAY CONNECTED WITH THE PRODUCTS, WHETHER SUCH CLAIM IS BASED ON CONTRACT, WARRANTY, NEGLIGENCE, OR STRICT LIABILITY.

In no event shall the responsibility of OMRON for any act exceed the individual price of the product on which liability is asserted.

IN NO EVENT SHALL OMRON BE RESPONSIBLE FOR WARRANTY, REPAIR, OR OTHER CLAIMS REGARDING THE PRODUCTS UNLESS OMRON'S ANALYSIS CONFIRMS THAT THE PRODUCTS WERE PROPERLY HANDLED, STORED, INSTALLED, AND MAINTAINED AND NOT SUBJECT TO CONTAMINATION, ABUSE, MISUSE, OR INAPPROPRIATE MODIFICATION OR REPAIR.

Application Considerations

SUITABILITY FOR USE

OMRON shall not be responsible for conformity with any standards, codes, or regulations that apply to the combination of products in the customer's application or use of the products.

At the customer's request, OMRON will provide applicable third party certification documents identifying ratings and limitations of use that apply to the products. This information by itself is not sufficient for a complete determination of the suitability of the products in combination with the end product, machine, system, or other application or use.

The following are some examples of applications for which particular attention must be given. This is not intended to be an exhaustive list of all possible uses of the products, nor is it intended to imply that the uses listed may be suitable for the products:

- Outdoor use, uses involving potential chemical contamination or electrical interference, or conditions or uses not described in this catalog.
- Nuclear energy control systems, combustion systems, railroad systems, aviation systems, medical equipment, amusement machines, vehicles, safety equipment, and installations subject to separate industry or government regulations.
- Systems, machines, and equipment that could present a risk to life or property.

Please know and observe all prohibitions of use applicable to the products.

NEVER USE THE PRODUCTS FOR AN APPLICATION INVOLVING SERIOUS RISK TO LIFE OR PROPERTY WITHOUT ENSURING THAT THE SYSTEM AS A WHOLE HAS BEEN DESIGNED TO ADDRESS THE RISKS, AND THAT THE OMRON PRODUCTS ARE PROPERLY RATED AND INSTALLED FOR THE INTENDED USE WITHIN THE OVERALL EQUIPMENT OR SYSTEM.

PROGRAMMABLE PRODUCTS

OMRON shall not be responsible for the user's programming of a programmable product, or any consequence thereof.

Disclaimers

CHANGE IN SPECIFICATIONS

Product specifications and accessories may be changed at any time based on improvements and other reasons.

It is our practice to change model numbers when published ratings or features are changed, or when significant construction changes are made. However, some specifications of the products may be changed without any notice. When in doubt, special model numbers may be assigned to fix or establish key specifications for your application on your request. Please consult with your OMRON representative at any time to confirm actual specifications of purchased products.

DIMENSIONS AND WEIGHTS

Dimensions and weights are nominal and are not to be used for manufacturing purposes, even when tolerances are shown.

PERFORMANCE DATA

Performance data given in this catalog is provided as a guide for the user in determining suitability and does not constitute a warranty. It may represent the result of OMRON's test conditions, and the users must correlate it to actual application requirements. Actual performance is subject to the OMRON Warranty and Limitations of Liability.

ERRORS AND OMISSIONS

The information in this document has been carefully checked and is believed to be accurate; however, no responsibility is assumed for clerical, typographical, or proofreading errors, or omissions.

2008.11

In the interest of product improvement, specifications are subject to change without notice.

OMRON Corporation
Industrial Automation Company

<http://www.ia.omron.com/>

(c)Copyright OMRON Corporation 2008 All Right Reserved.

Компания «Life Electronics» занимается поставками электронных компонентов импортного и отечественного производства от производителей и со складов крупных дистрибьюторов Европы, Америки и Азии.

С конца 2013 года компания активно расширяет линейку поставок компонентов по направлению коаксиальный кабель, кварцевые генераторы и конденсаторы (керамические, пленочные, электролитические), за счёт заключения дистрибьюторских договоров

Мы предлагаем:

- Конкурентоспособные цены и скидки постоянным клиентам.
- Специальные условия для постоянных клиентов.
- Подбор аналогов.
- Поставку компонентов в любых объемах, удовлетворяющих вашим потребностям.
- Приемлемые сроки поставки, возможна ускоренная поставка.
- Доставку товара в любую точку России и стран СНГ.
- Комплексную поставку.
- Работу по проектам и поставку образцов.
- Формирование склада под заказчика.
- Сертификаты соответствия на поставляемую продукцию (по желанию клиента).
- Тестирование поставляемой продукции.
- Поставку компонентов, требующих военную и космическую приемку.
- Входной контроль качества.
- Наличие сертификата ISO.

В составе нашей компании организован Конструкторский отдел, призванный помогать разработчикам, и инженерам.

Конструкторский отдел помогает осуществить:

- Регистрацию проекта у производителя компонентов.
- Техническую поддержку проекта.
- Защиту от снятия компонента с производства.
- Оценку стоимости проекта по компонентам.
- Изготовление тестовой платы монтаж и пусконаладочные работы.



Тел: +7 (812) 336 43 04 (многоканальный)
Email: org@lifeelectronics.ru