



Is Now Part of



ON Semiconductor®

To learn more about ON Semiconductor, please visit our website at
www.onsemi.com

Please note: As part of the Fairchild Semiconductor integration, some of the Fairchild orderable part numbers will need to change in order to meet ON Semiconductor's system requirements. Since the ON Semiconductor product management systems do not have the ability to manage part nomenclature that utilizes an underscore (_), the underscore (_) in the Fairchild part numbers will be changed to a dash (-). This document may contain device numbers with an underscore (_). Please check the ON Semiconductor website to verify the updated device numbers. The most current and up-to-date ordering information can be found at www.onsemi.com. Please email any questions regarding the system integration to Fairchild_questions@onsemi.com.

ON Semiconductor and the ON Semiconductor logo are trademarks of Semiconductor Components Industries, LLC dba ON Semiconductor or its subsidiaries in the United States and/or other countries. ON Semiconductor owns the rights to a number of patents, trademarks, copyrights, trade secrets, and other intellectual property. A listing of ON Semiconductor's product/patent coverage may be accessed at www.onsemi.com/site/pdf/Patent-Marking.pdf. ON Semiconductor reserves the right to make changes without further notice to any products herein. ON Semiconductor makes no warranty, representation or guarantee regarding the suitability of its products for any particular purpose, nor does ON Semiconductor assume any liability arising out of the application or use of any product or circuit, and specifically disclaims any and all liability, including without limitation special, consequential or incidental damages. Buyer is responsible for its products and applications using ON Semiconductor products, including compliance with all laws, regulations and safety requirements or standards, regardless of any support or applications information provided by ON Semiconductor. "Typical" parameters which may be provided in ON Semiconductor data sheets and/or specifications can and do vary in different applications and actual performance may vary over time. All operating parameters, including "Typicals" must be validated for each customer application by customer's technical experts. ON Semiconductor does not convey any license under its patent rights nor the rights of others. ON Semiconductor products are not designed, intended, or authorized for use as a critical component in life support systems or any FDA Class 3 medical devices or medical devices with a same or similar classification in a foreign jurisdiction or any devices intended for implantation in the human body. Should Buyer purchase or use ON Semiconductor products for any such unintended or unauthorized application, Buyer shall indemnify and hold ON Semiconductor and its officers, employees, subsidiaries, affiliates, and distributors harmless against all claims, costs, damages, and expenses, and reasonable attorney fees arising out of, directly or indirectly, any claim of personal injury or death associated with such unintended or unauthorized use, even if such claim alleges that ON Semiconductor was negligent regarding the design or manufacture of the part. ON Semiconductor is an Equal Opportunity/Affirmative Action Employer. This literature is subject to all applicable copyright laws and is not for resale in any manner.



FPF2000-FPF2007 IntelliMAX™ Advanced Load Management Products

Features

- 1.8 to 5.5V Input Voltage Range
- Controlled Turn-On
- 50mA and 100mA Current Limit Options
- Undervoltage Lockout
- Thermal Shutdown
- $1\mu\text{A}$ Shutdown Current
- Auto restart
- Fast Current limit Response Time
 - 3 μs to Moderate Over Currents
 - 20ns to Hard Shorts
- Fault Blanking
- RoHS Compliant

Applications

- PDAs
- Cell Phones
- GPS Devices
- MP3 Players
- Digital Cameras
- Peripheral Ports
- Hot Swap Supplies



General Description

The FPF2000 through FPF2007 is a family of load switches which provide full protection to systems and loads which may encounter large current conditions. These devices contain a 0.7 Ω current-limited P-channel MOSFET which can operate over an input voltage range of 1.8-5.5V. Switch control is by a logic input (ON) capable of interfacing directly with low voltage control signals. Each part contains thermal shutdown protection which shuts off the switch to prevent damage to the part when a continuous over-current condition causes excessive heating.

When the switch current reaches the current limit, the part operates in a constant current mode to prohibit excessive currents from causing damage. For the FPF2000-FPF2002 and FPF2004-FPF2006, if the constant current condition still persists after 10ms, these parts will shut off the switch and pull the fault signal pin (FLAGB) low. The FPF2000, FPF2001, FPF2004 and FPF2005, have an auto-restart feature which will turn the switch on again after 80ms if the ON pin is still active. The FPF2002 and FPF2006 do not have this auto-restart feature so the switch will remain off until the ON pin is cycled. For the FPF2003 and FPF2007, a current limit condition will immediately pull the fault signal pin low and the part will remain in the constant-current mode until the switch current falls below the current limit. For the FPF2000 through FPF2003, the minimum current limit is 50mA while that for the FPF2004 through FPF2007 is 100mA.

These parts are available in a space-saving 5 pin SC-70 package.

Ordering Information

Part	Current Limit [mA]	Current Limit Blanking Time [ms]	Auto-Restart Time [ms]	ON Pin Activity	Top Mark
FPF2000	50	10	80	Active HI	200
FPF2001	50	10	80	Active LO	201
FPF2002	50	10	NA	Active HI	202
FPF2003	50	0	NA	Active HI	203
FPF2004	100	10	80	Active HI	204
FPF2005	100	10	80	Active LO	205
FPF2006	100	10	NA	Active HI	206
FPF2007	100	0	NA	Active HI	207

Typical Application Circuit

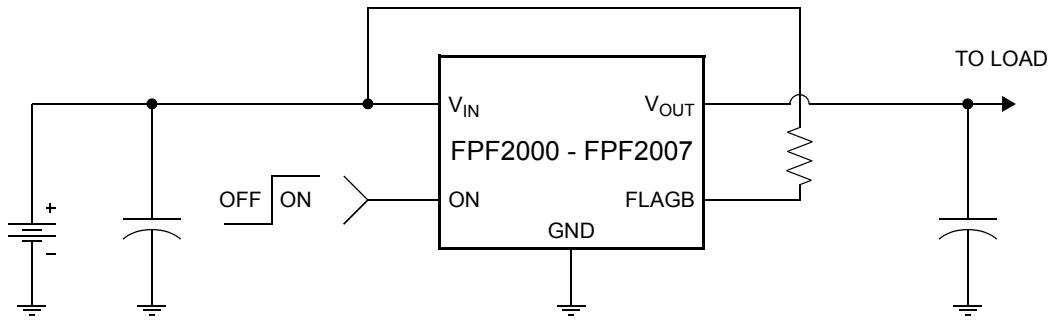

Functional Block Diagram

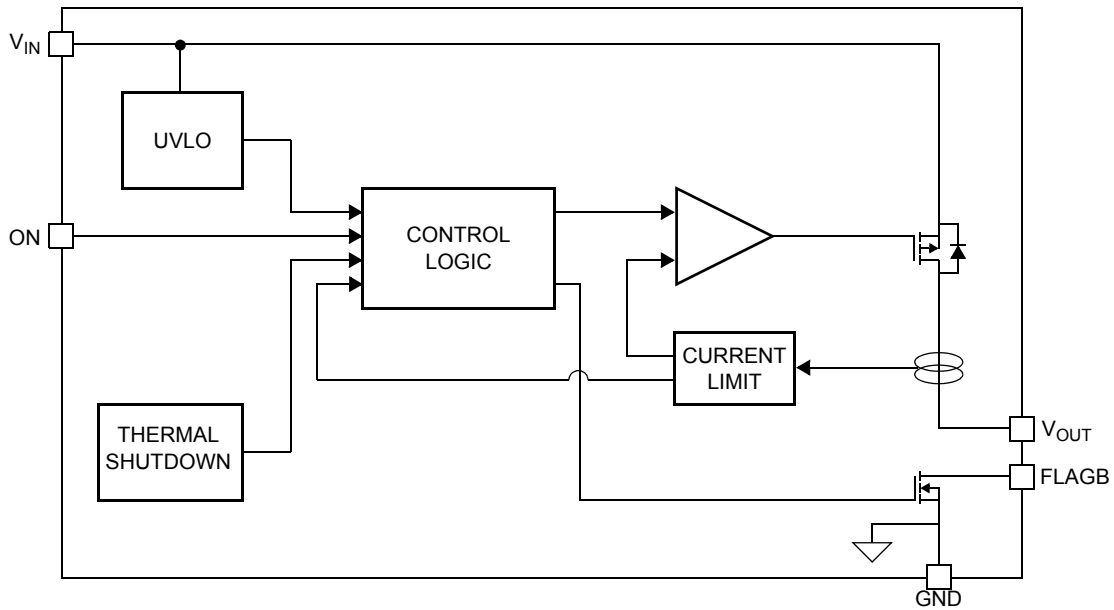

Pin Configuration

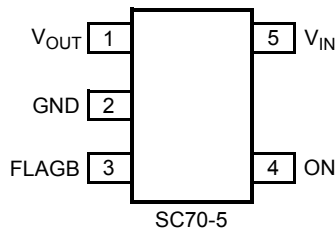

Pin Description

Pin	Name	Function
1	V_{OUT}	Switch Output: Output of the power switch
2	GND	Ground
3	$FLAGB$	Fault Output: Active LO, open drain output which indicates an over current, supply under voltage or over temperature state.
4	ON	On Control Input
5	V_{IN}	Supply Input: Input to the power switch and the supply voltage for the IC

Absolute Maximum Ratings

Parameter	Min	Max	Unit
V_{IN} , V_{OUT} , ON, FLAGB to GND	-0.3	6	V
Power Dissipation @ $T_A = 25^\circ\text{C}$ (note 1)		250	mW
Operating Junction Temperature	-40	125	$^\circ\text{C}$
Storage Temperature	-65	150	$^\circ\text{C}$
Thermal Resistance, Junction to Ambient		400	$^\circ\text{C}/\text{W}$
Electrostatic Discharge Protection	HBM	4000	V
	MM	400	V

Recommended Operating Range

Parameter	Min	Max	Unit
V_{IN}	1.8	5.5	V
Ambient Operating Temperature, T_A	-40	85	$^\circ\text{C}$

Electrical Characteristics

$V_{IN} = 1.8$ to 5.5V , $T_A = -40$ to $+85^\circ\text{C}$ unless otherwise noted. Typical values are at $V_{IN} = 3.3\text{V}$ and $T_A = 25^\circ\text{C}$.

Parameter	Symbol	Conditions	Min	Typ	Max	Units	
Basic Operation							
Operating Voltage	V_{IN}		1.8		5.5	V	
Quiescent Current	I_Q	$I_{OUT} = 0\text{mA}$		60		μA	
		V_{ON} active	$V_{IN} = 1.8$ to 3.3V $V_{IN} = 3.3$ to 5.5V		100		
Shutdown Current	I_{SHDN}				1	μA	
Latch-Off Current (note 2)	$I_{LATC/OFF}$	$V_{ON} = V_{IN}$, after an overcurrent fault		40		μA	
On-Resistance	R_{ON}	$V_{IN} = 3.3\text{V}$, $I_{OUT} = 20\text{mA}$, $T_A = 25^\circ\text{C}$		0.7	1	Ω	
		$V_{IN} = 3.3\text{V}$, $I_{OUT} = 20\text{mA}$, $T_A = 85^\circ\text{C}$		0.85	1.2		
		$V_{IN} = 3.3\text{V}$, $I_{OUT} = 20\text{mA}$, $T_A = -40^\circ\text{C}$ to $+85^\circ\text{C}$	0.27		1.2		
ON Input Logic High Voltage	V_{IH}	$V_{IN} = 1.8\text{V}$	0.8			V	
		$V_{IN} = 5.5\text{V}$	1.5				
ON Input Logic Low Voltage	V_{IL}	$V_{IN} = 1.8\text{V}$			0.5	V	
		$V_{IN} = 5.5\text{V}$			0.9		
ON Input Leakage		$V_{ON} = V_{IN}$ or GND			1	μA	
Off Switch Leakage	I_{SWOFF}	$V_{ON} = 0\text{V}$, $V_{OUT} = 0\text{V}$ @ $V_{IN} = 5.5\text{V}$, $T_A = 85^\circ\text{C}$			1	μA	
		$V_{ON} = 0\text{V}$, $V_{OUT} = 0\text{V}$ @ $V_{IN} = 3.3\text{V}$, $T_A = 25^\circ\text{C}$		10	100		nA
FLAGB Output Logic Low Voltage		$V_{IN} = 5\text{V}$, $I_{SINK} = 10\text{mA}$		0.1	0.2	V	
		$V_{IN} = 1.8\text{V}$, $I_{SINK} = 10\text{mA}$		0.1	0.3		
FLAGB Output High Leakage Current		$V_{IN} = 5\text{V}$, Switch on			1	μA	
Protections							
Current Limit	I_{LIM}	$V_{IN} = 3.3\text{V}$, $V_{OUT} = 3.0\text{V}$	FPF2000, FPF2001, FPF2002, FPF2003	50	75	100	mA
			FPF2004, FPF2005, FPF2006, FPF2007	100	150	200	
Thermal Shutdown		Shutdown Threshold		140		$^\circ\text{C}$	
		Return from Shutdown		130			
		Hysteresis		10			

Electrical Characteristics Cont.

$V_{IN} = 1.8$ to $5.5V$, $T_A = -40$ to $+85^\circ C$ unless otherwise noted. Typical values are at $V_{IN} = 3.3V$ and $T_A = 25^\circ C$.

Parameter	Symbol	Conditions	Min	Typ	Max	Units
Protections						
Under Voltage Shutdown	UVLO	V_{IN} Increasing	1.5	1.6	1.7	V
Under Voltage Shutdown Hysteresis				50		mV
Dynamic						
Turn On Time	t_{ON}	$R_L = 500\Omega$, $C_L = 0.1\mu F$		50		μs
Turn Off Time	t_{OFF}	$R_L = 500\Omega$, $C_L = 0.1\mu F$		0.5		μs
V_{OUT} Rise Time	t_R	$R_L = 500\Omega$, $C_L = 0.1\mu F$		10		μs
V_{OUT} Fall Time	t_F	$R_L = 500\Omega$, $C_L = 0.1\mu F$		0.1		μs
Over Current Blanking Time	t_{BLANK}	FPF2000, FPF2001, FPF2002, FPF2004, FPF2005, FPF2006	5	10	20	ms
Auto-Restart Time	t_{RSTRT}	FPF2000, FPF2001, FPF2004, FPF2005	40	80	160	ms
Short Circuit Response Time		$V_{IN} = V_{ON} = 3.3V$. Moderate Over-Current Condition.		3		μs
		$V_{IN} = V_{ON} = 3.3V$. Hard Short.		20		ns

Note 1: Package power dissipation on 1 square inch pad, 2 oz. copper board.

Note 2: Applicable only to FPF2002 and FPF2006. Latchoff current does not include current flowing into FLAGB.

Typical Characteristics

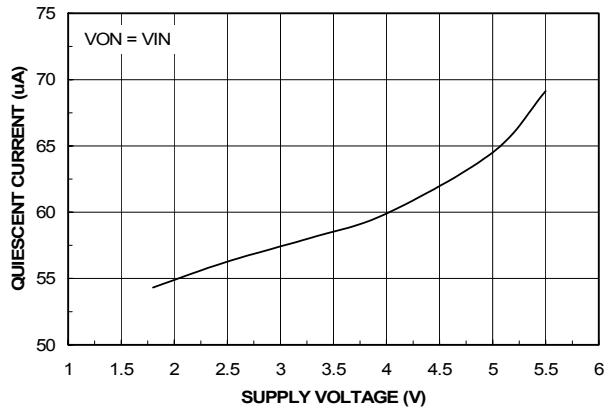

Figure 1. Quiescent Current vs. Input Voltage

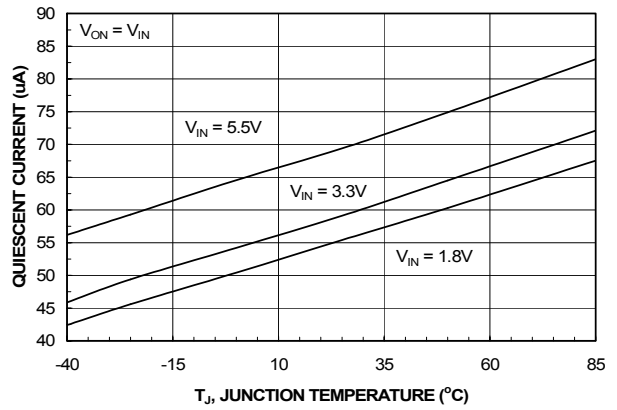

Figure 2. Quiescent Current vs. Temperature

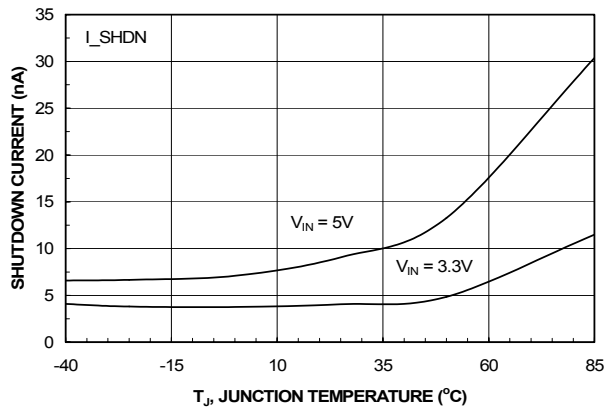

Figure 3. $I_{SHUTDOWN}$ Current vs. Temperature

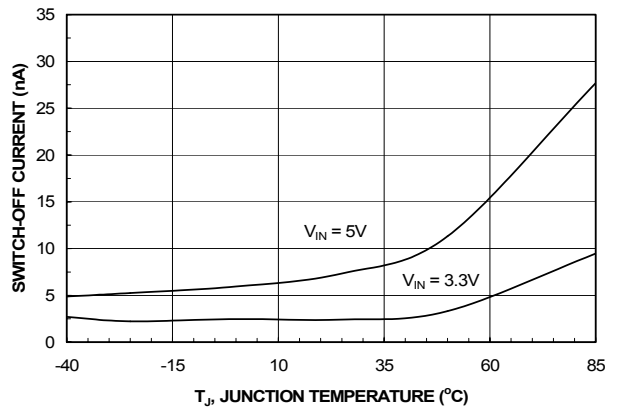

Figure 4. $I_{SWITCH-OFF}$ Current vs. Temperature

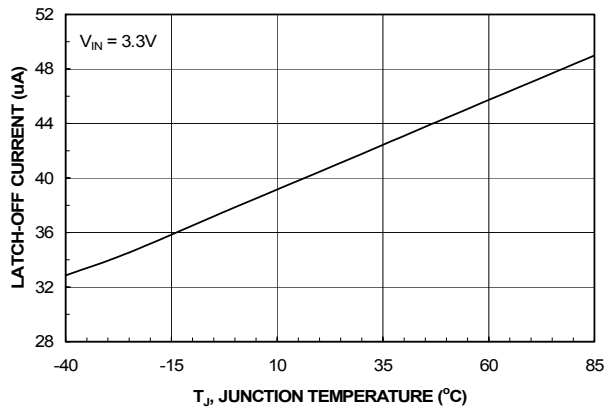

Figure 5. $I_{LATCHOFF}$ vs. Temperature

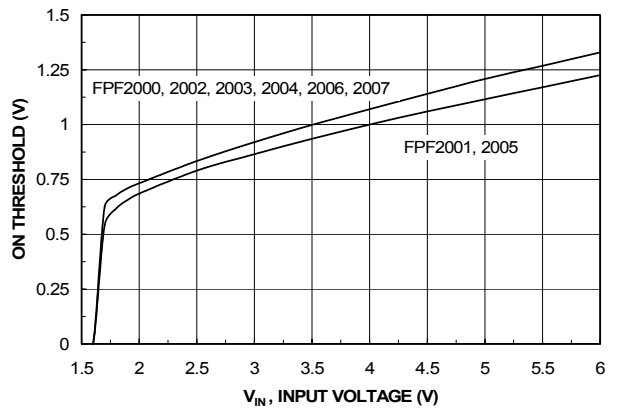

Figure 6. V_{IH} vs. V_{IN}

Typical Characteristics

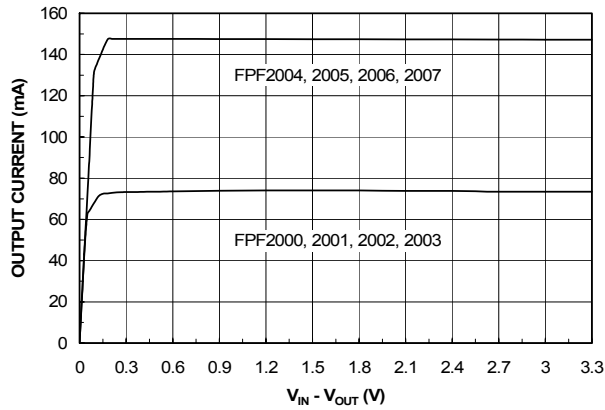

Figure 7. Current Limit vs. Output Voltage

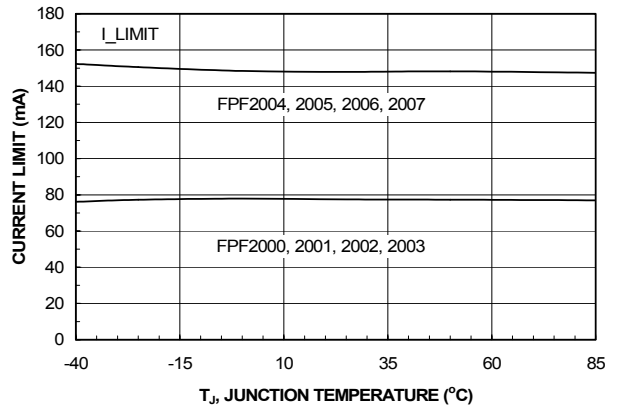

Figure 8. Current Limit vs. Temperature

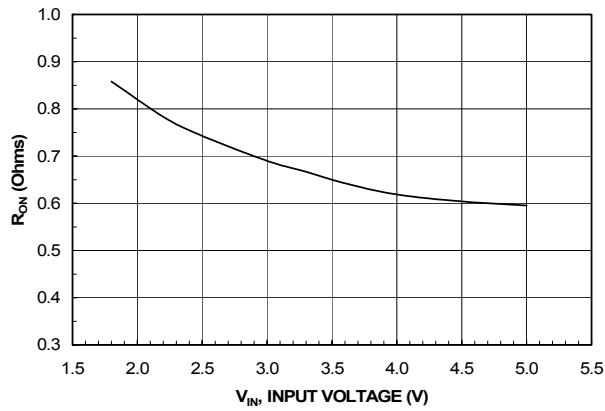

Figure 9. R_{ON} vs. V_{IN}

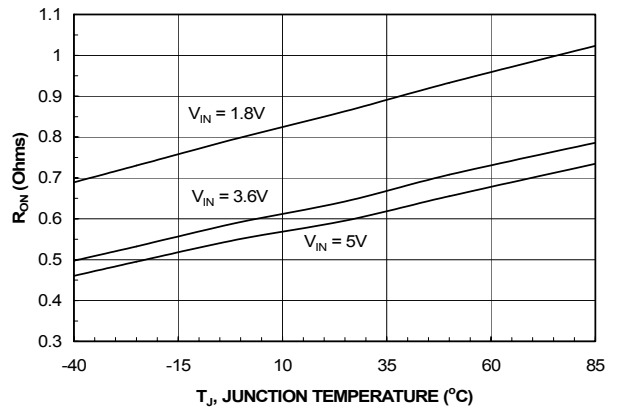

Figure 10. R_{ON} vs. Temperature

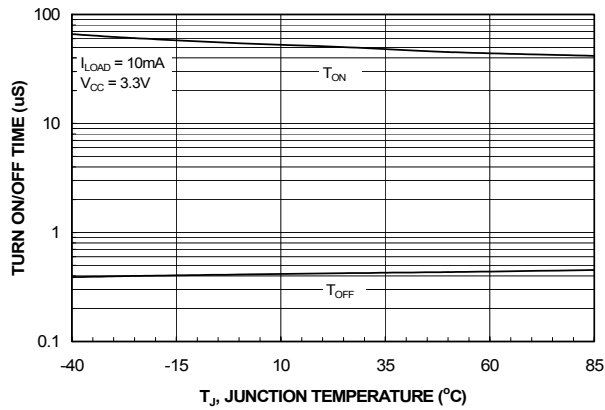

Figure 11. T_{ON}/T_{OFF} vs. Temperature

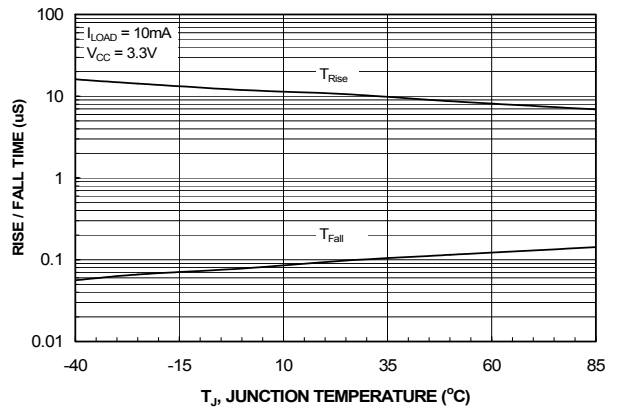

Figure 12. T_{RISE}/T_{FALL} vs. Temperature

Typical Characteristics

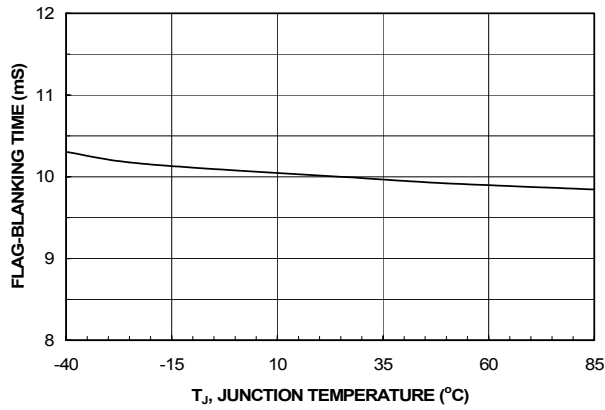

Figure 13. T_{BLANK} vs. Temperature

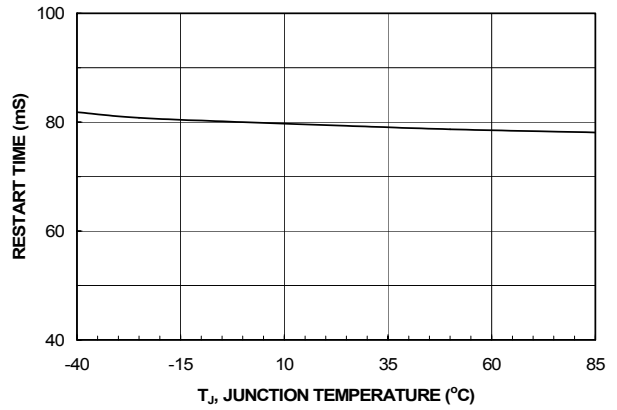

Figure 14. T_{RESTART} vs. Temperature

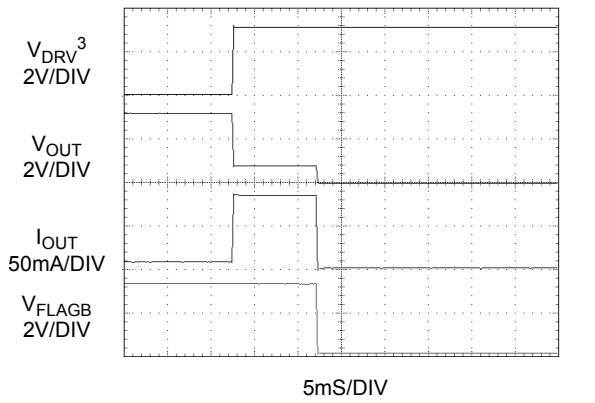

Figure 15. T_{BLANK} Response

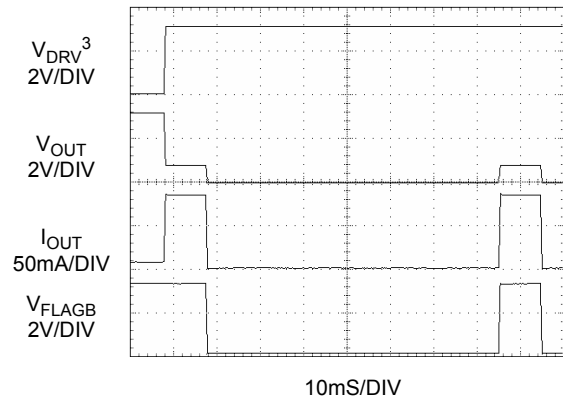

Figure 16. T_{RESTART} Response

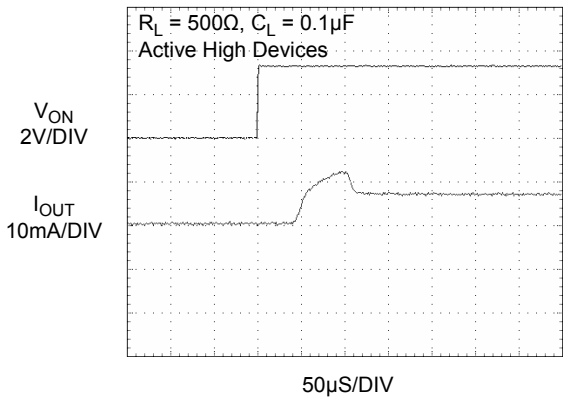

Figure 17. T_{ON} Response

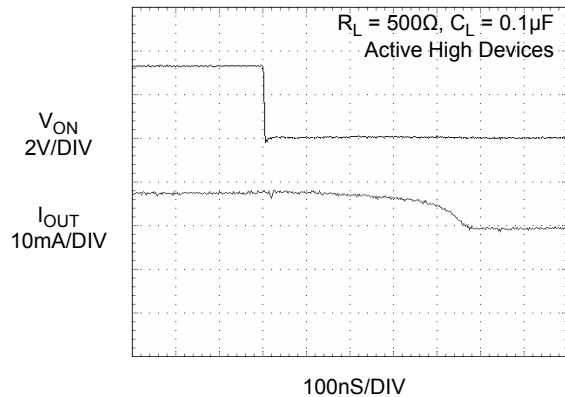

Figure 18. T_{OFF} Response

Typical Characteristics

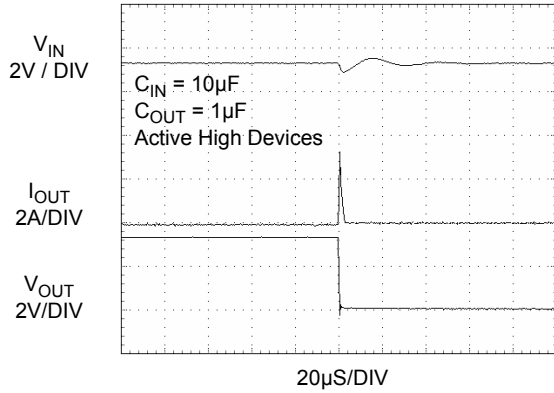

Figure 19. Short Circuit Response Time (Output Shorted to GND)

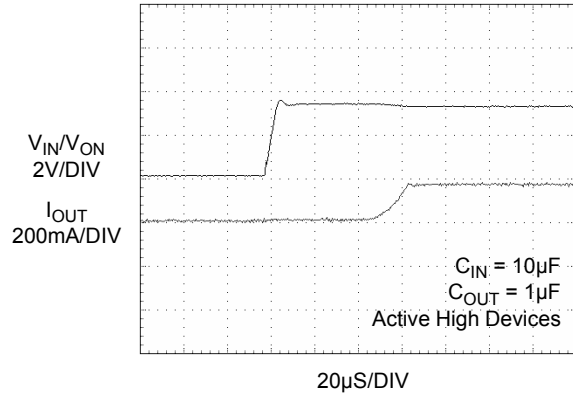

Figure 20. Current Limit Response (Switch power up to hard short)

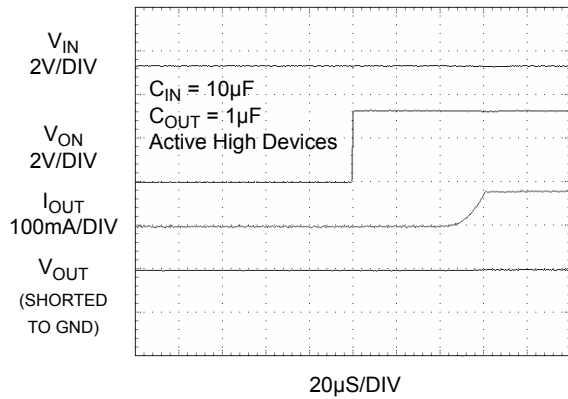

Figure 21. Current Limit Response Time

Note 3: V_{DRV} signal forces the device to go into overcurrent condition.

Description of Operation

The FPF2000-FPF2007 are current limited switches that protect systems and loads which can be damaged or disrupted by the application of high currents. The core of each device is a 0.7Ω P-channel MOSFET and a controller capable of functioning over a wide input operating range of 1.8-5.5V. The controller protects against system malfunctions through current limiting, under-voltage lockout and thermal shutdown. The current limit is preset for either 50mA or 100mA.

On/Off Control

The ON pin controls the state of the switch. Active HI and LO versions are available. Refer to the Ordering Information for details. Activating ON continuously holds the switch in the on state so long as there is no fault. For all versions, an under-voltage on VIN or a junction temperature in excess of 150°C overrides the ON control to turn off the switch. In addition, excessive currents will cause the switch to turn off in FPF2000-FPF2002 and FPF2004-FPF2007. The FPF2000, FPF2001, FPF2004 and FPF2005 have an Auto-Restart feature which will automatically turn the switch on again after 80ms. For the FPF2002 and FPF2006, the ON pin must be toggled to turn-on the switch again. The FPF2003 and FPF2007 do not turn off in response to a over current condition but instead remain operating in a constant current mode so long as ON is active and the thermal shutdown or under-voltage lockout have not activated.

Fault Reporting

Upon the detection of an over-current, an input under-voltage, or an over-temperature condition, the FLAGB signals the fault mode by activating LO. For the FPF2000-FPF2002 and FPF2004-FPF2006, the FLAGB goes LO at the end of the blanking time while FLAGB goes LO immediately for the FPF2003 and FPF2007. FLAGB remains LO through the Auto-Restart Time for the FPF2000, FPF2001 FPF2004 and FPF2005. For the FPF2002 and FPF2006, FLAGB is latched LO and ON must be toggled to release it. With the FPF2003 and FPF2007, FLAGB is LO during the faults and immediately returns HI at the end of the fault condition. FLAGB is an open-drain MOSFET which requires a pull-up resistor between VIN and FLAGB. During shutdown, the pull-down on FLAGB is disabled to reduce current draw from the supply.

Current Limiting

The current limit ensures that the current through the switch doesn't exceed a maximum value while not limiting at less than a minimum value. For the FPF2000-FPF2003 the minimum current is 50mA and the maximum current is 100mA and for the FPF2004-FPF2007 the minimum current is 100mA and the maximum current is 200mA. The FPF2000-FPF2002 and the FPF2004-FPF2006, have a blanking time of 10ms, nominally, during which the switch will act as a constant current source. At the end of the blanking time, the switch will be turned-off and the FLAGB pin will activate to indicate that current limiting has occurred. The FPF2003 and FPF2007 have no current limit blanking period so immediately upon a current limit condition FLAGB is activated. These parts will remain in a constant current state until the ON pin is deactivated or the thermal shutdown turns-off the switch.

Reverse Voltage

If the voltage at the VOUT pin is larger than the VIN pin, large currents may flow and can cause permanent damage to the device. FPF2000-FPF2007 is designed to control current flow from VIN to VOUT.

Under-Voltage Lockout

The under-voltage lockout turns-off the switch if the input voltage drops below the under-voltage lockout threshold. With the ON pin active the input voltage rising above the under-voltage lockout threshold will cause a controlled turn-on of the switch which limits current over-shoots.

Thermal Shutdown

The thermal shutdown protects the die from internally or externally generated excessive temperatures. During an over-temperature condition the FLAGB is activated and the switch is turned-off. The switch automatically turns-on again if temperature of the die drops below the threshold temperature.

Application Information

Typical Application

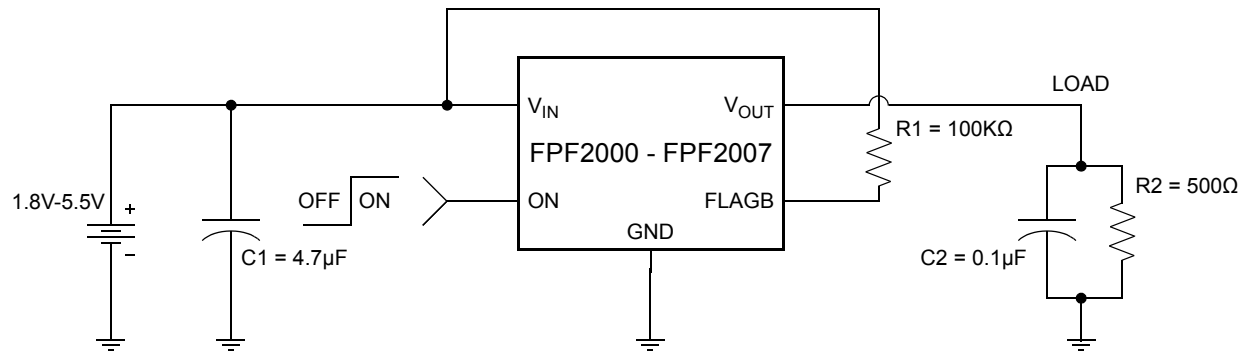

Input Capacitor

To limit the voltage drop on the input supply caused by transient in-rush currents when the switch turns-on into a discharged load capacitor or a short-circuit, a capacitor needs to be placed between V_{IN} and GND. A 4.7µF ceramic capacitor, C_{IN} , must be placed close to the V_{IN} pin. A higher value of C_{IN} can be used to further reduce the voltage drop experienced as the switch is turned on into a large capacitive load.

Output Capacitor

A 0.1µF capacitor C_{OUT} , should be placed between V_{OUT} and GND. This capacitor will prevent parasitic board inductances from forcing V_{OUT} below GND when the switch turns-off. For the FPF2000-FPF2002 and the FPF2004-FPF2006, the total output capacitance needs to be kept below a maximum value, $C_{OUT(max)}$, to prevent the part from registering an over-current condition and turning-off the switch. The maximum output capacitance can be determined from the following formula,

$$C_{OUT} = \frac{I_{LIM(max)} \times t_{BLANK(min)}}{V_{IN}} \quad (1)$$

Due to the integral body diode in the PMOS switch, a C_{IN} greater than C_{OUT} is highly recommended. A C_{OUT} greater than C_{IN} can cause V_{OUT} to exceed V_{IN} when the system supply is removed. This could result in current flow through the body diode from V_{OUT} to V_{IN} .

Power Dissipation

During normal operation as a switch, the power dissipation is small and has little effect on the operating temperature of the part. The parts with the higher current limits will dissipate the most power and that will only be,

$$P = (I_{LIM})^2 \times R_{DS} = (0.2)^2 \times 0.7 = 28\text{mW} \quad (2)$$

If the part goes into current limit the maximum power dissipation will occur when the output is shorted to ground. For the FPF2000, FPF2001, FPF2004 and FPF2005, the power dissipation will scale by the Auto-Restart Time, $t_{RESTART}$, and the Over Current Blanking Time, t_{BLANK} , so that the maximum power dissipated is,

$$P(max) = \frac{t_{BLANK}}{t_{RESTART} + t_{BLANK}} \times (V_{IN(max)}) \times I_{LIM(max)}$$

$$= \frac{10}{80 + 10} \times 5.5 \times 0.2 = 1.22\text{mW} \quad (3)$$

When using the FPF2002 and FPF2006 attention must be given to the manual resetting of the part. Continuously resetting the part at a high duty cycle when a short on the output is present can cause the temperature of the part to increase. The junction temperature will only be allowed to increase to the thermal shutdown threshold. Once this temperature has been reached, toggling ON will not turn-on the switch until the junction temperature drops. For the FPF2003 and FPF2007, a short on the output will cause the part to operate in a constant current state dissipating a worst case power as calculated in (3) until the thermal shutdown activates. It will then cycle in and out of thermal shutdown so long as the ON pin is active and the short is present.

Board Layout

For best performance, all traces should be as short as possible. To be most effective, the input and output capacitors should be placed close to the device to minimize the effects that parasitic trace inductances may have on normal and short-circuit operation. Using wide traces for V_{IN} , V_{OUT} and GND will help minimize parasitic electrical effects along with minimizing the case to ambient thermal impedance.

Dimensional Outline and Pad Layout

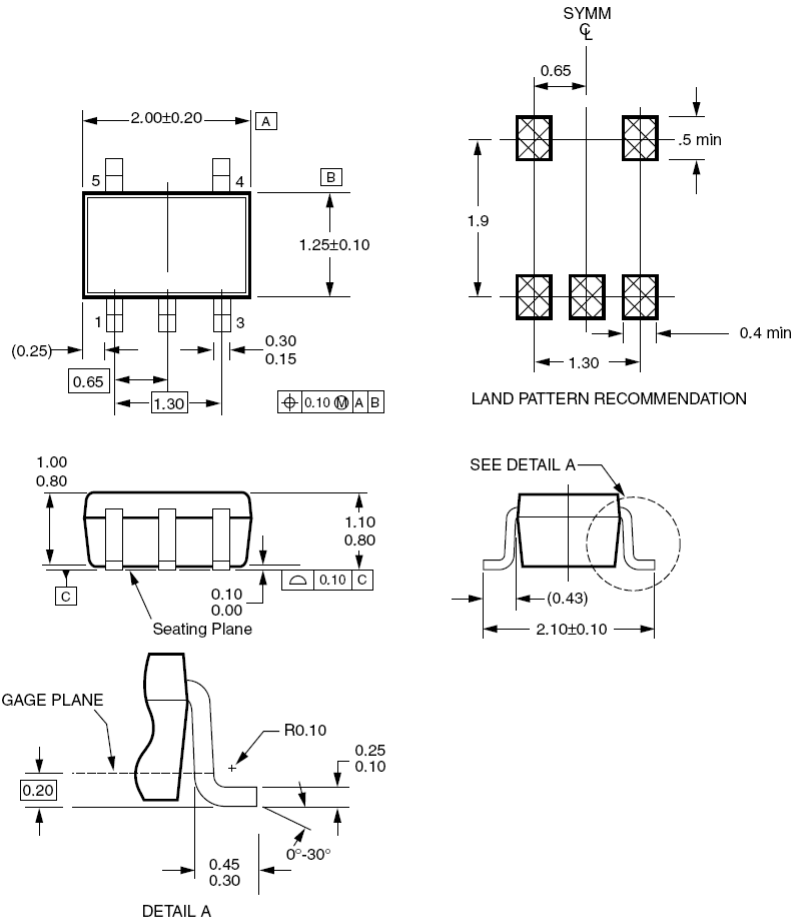





NOTES:

- A. THIS PACKAGE CONFORMS TO EIAJ SC-88A, 1996.
- B. DIMENSIONS ARE IN MILLIMETERS.
- C. DIMENSIONS DO NOT INCLUDE BURRS OR MOLD FLASH.



TRADEMARKS

The following includes registered and unregistered trademarks and service marks, owned by Fairchild Semiconductor and/or its global subsidiaries, and is not intended to be an exhaustive list of all such trademarks.

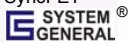
Build it Now™	FRFET®	Programmable Active Droop™	the power™
CorePLUS™	Global Power ResourceSM	QFET®	franchise
CorePOWER™	Green FPS™	QS™	TinyBoost™
CROSSVOLT™	Green FPS™ e-Series™	Quiet Series™	TinyBuck™
CTL™	GTO™	RapidConfigure™	TinyLogic®
Current Transfer Logic™	IntelliMAX™	 ™	TINYOPTO™
EcoSPARK®	ISOPLANAR™	Saving our world, 1mW/W/kW at a time™	TinyPower™
EfficientMax™	MegaBuck™	SmartMax™	TinyPWM™
EZSWITCH™ *	MICROCOUPLER™	SMART START™	TinyWire™
 ™	MicroFET™	SPM®	μSerDes™
 ®	MicroPak™	STEALTH™	 SerDes®
Fairchild®	MillerDrive™	SuperFET™	UHC®
Fairchild Semiconductor®	MotionMax™	SuperSOT™_3	Ultra FRFET™
FACT Quiet Series™	Motion-SPM™	SuperSOT™_6	UniFET™
FACT®	OPTOLOGIC®	SuperSOT™_8	VCX™
FAST®	OPTOPLANAR®	SupreMOS™	VisualMax™
FastvCore™	 ®	SyncFET™	XS™
FlashWriter® *	PDP SPM™	 SYSTEM GENERAL®	
FPS™	Power-SPM™	The Power Franchise®	
F-PFS™	PowerTrench®		
	PowerXS™		

* EZSWITCH™ and FlashWriter® are trademarks of System General Corporation, used under license by Fairchild Semiconductor.

DISCLAIMER

FAIRCHILD SEMICONDUCTOR RESERVES THE RIGHT TO MAKE CHANGES WITHOUT FURTHER NOTICE TO ANY PRODUCTS HEREIN TO IMPROVE RELIABILITY, FUNCTION, OR DESIGN. FAIRCHILD DOES NOT ASSUME ANY LIABILITY ARISING OUT OF THE APPLICATION OR USE OF ANY PRODUCT OR CIRCUIT DESCRIBED HEREIN; NEITHER DOES IT CONVEY ANY LICENSE UNDER ITS PATENT RIGHTS, NOR THE RIGHTS OF OTHERS. THESE SPECIFICATIONS DO NOT EXPAND THE TERMS OF FAIRCHILD'S WORLDWIDE TERMS AND CONDITIONS, SPECIFICALLY THE WARRANTY THEREIN, WHICH COVERS THESE PRODUCTS.

LIFE SUPPORT POLICY

FAIRCHILD'S PRODUCTS ARE NOT AUTHORIZED FOR USE AS CRITICAL COMPONENTS IN LIFE SUPPORT DEVICES OR SYSTEMS WITHOUT THE EXPRESS WRITTEN APPROVAL OF FAIRCHILD SEMICONDUCTOR CORPORATION.

As used herein:

1. Life support devices or systems are devices or systems which, (a) are intended for surgical implant into the body or (b) support or sustain life, and (c) whose failure to perform when properly used in accordance with instructions for use provided in the labeling, can be reasonably expected to result in a significant injury of the user.
2. A critical component in any component of a life support, device, or system whose failure to perform can be reasonably expected to cause the failure of the life support device or system, or to affect its safety or effectiveness.

ANTI-COUNTERFEITING POLICY

Fairchild Semiconductor Corporation's Anti-Counterfeiting Policy. Fairchild's Anti-Counterfeiting Policy is also stated on our external website, www.fairchildsemi.com, under Sales Support.

Counterfeiting of semiconductor parts is a growing problem in the industry. All manufacturers of semiconductor products are experiencing counterfeiting of their parts. Customers who inadvertently purchase counterfeit parts experience many problems such as loss of brand reputation, substandard performance, failed application, and increased cost of production and manufacturing delays. Fairchild is taking strong measures to protect ourselves and our customers from the proliferation of counterfeit parts. Fairchild strongly encourages customers to purchase Fairchild parts either directly from Fairchild or from Authorized Fairchild Distributors who are listed by country on our web page cited above. Products customers buy either from fairchild directly or from Authorized Fairchild Distributors are genuine parts, have full traceability, meet Fairchild's quality standards for handling and storage and provide access to Fairchild's full range of up-to-date technical and product information. Fairchild and our Authorized Distributors will stand behind all warranties and will appropriately address and warranty issues that may arise. Fairchild will not provide any warranty coverage or other assistance for parts bought from Unauthorized Sources. Fairchild is committed to combat this global problem and encourage our customers to do their part in stopping this practice by buying direct or from authorized distributors.

PRODUCT STATUS DEFINITIONS

Definition of Terms

Datasheet Identification	Product Status	Definition
Advance Information	Formative / In Design	Datasheet contains the design specifications for product development. Specifications may change in any manner without notice.
Preliminary	First Production	Datasheet contains preliminary data; supplementary data will be published at a later date. Fairchild Semiconductor reserves the right to make changes at any time without notice to improve design.
No Identification Needed	Full Production	Datasheet contains final specifications. Fairchild Semiconductor reserves the right to make changes at any time without notice to improve the design.
Obsolete	Not In Production	Datasheet contains specifications on a product that is discontinued by Fairchild Semiconductor. The datasheet is for reference information only.

Rev. I37

ON Semiconductor and  are trademarks of Semiconductor Components Industries, LLC dba ON Semiconductor or its subsidiaries in the United States and/or other countries. ON Semiconductor owns the rights to a number of patents, trademarks, copyrights, trade secrets, and other intellectual property. A listing of ON Semiconductor's product/patent coverage may be accessed at www.onsemi.com/site/pdf/Patent-Marking.pdf. ON Semiconductor reserves the right to make changes without further notice to any products herein. ON Semiconductor makes no warranty, representation or guarantee regarding the suitability of its products for any particular purpose, nor does ON Semiconductor assume any liability arising out of the application or use of any product or circuit, and specifically disclaims any and all liability, including without limitation special, consequential or incidental damages. Buyer is responsible for its products and applications using ON Semiconductor products, including compliance with all laws, regulations and safety requirements or standards, regardless of any support or applications information provided by ON Semiconductor. "Typical" parameters which may be provided in ON Semiconductor data sheets and/or specifications can and do vary in different applications and actual performance may vary over time. All operating parameters, including "Typicals" must be validated for each customer application by customer's technical experts. ON Semiconductor does not convey any license under its patent rights nor the rights of others. ON Semiconductor products are not designed, intended, or authorized for use as a critical component in life support systems or any FDA Class 3 medical devices or medical devices with a same or similar classification in a foreign jurisdiction or any devices intended for implantation in the human body. Should Buyer purchase or use ON Semiconductor products for any such unintended or unauthorized application, Buyer shall indemnify and hold ON Semiconductor and its officers, employees, subsidiaries, affiliates, and distributors harmless against all claims, costs, damages, and expenses, and reasonable attorney fees arising out of, directly or indirectly, any claim of personal injury or death associated with such unintended or unauthorized use, even if such claim alleges that ON Semiconductor was negligent regarding the design or manufacture of the part. ON Semiconductor is an Equal Opportunity/Affirmative Action Employer. This literature is subject to all applicable copyright laws and is not for resale in any manner.

PUBLICATION ORDERING INFORMATION

LITERATURE FULFILLMENT:

Literature Distribution Center for ON Semiconductor
19521 E. 32nd Pkwy, Aurora, Colorado 80011 USA
Phone: 303-675-2175 or 800-344-3860 Toll Free USA/Canada
Fax: 303-675-2176 or 800-344-3867 Toll Free USA/Canada
Email: orderlit@onsemi.com

N. American Technical Support: 800-282-9855 Toll Free
USA/Canada
Europe, Middle East and Africa Technical Support:
Phone: 421 33 790 2910
Japan Customer Focus Center
Phone: 81-3-5817-1050

ON Semiconductor Website: www.onsemi.com
Order Literature: <http://www.onsemi.com/orderlit>
For additional information, please contact your local
Sales Representative

Mouser Electronics

Authorized Distributor

Click to View Pricing, Inventory, Delivery & Lifecycle Information:

[ON Semiconductor:](#)

[FPF2006](#)

Компания «Life Electronics» занимается поставками электронных компонентов импортного и отечественного производства от производителей и со складов крупных дистрибьюторов Европы, Америки и Азии.

С конца 2013 года компания активно расширяет линейку поставок компонентов по направлению коаксиальный кабель, кварцевые генераторы и конденсаторы (керамические, пленочные, электролитические), за счёт заключения дистрибьюторских договоров

Мы предлагаем:

- Конкурентоспособные цены и скидки постоянным клиентам.
- Специальные условия для постоянных клиентов.
- Подбор аналогов.
- Поставку компонентов в любых объемах, удовлетворяющих вашим потребностям.
- Приемлемые сроки поставки, возможна ускоренная поставка.
- Доставку товара в любую точку России и стран СНГ.
- Комплексную поставку.
- Работу по проектам и поставку образцов.
- Формирование склада под заказчика.
- Сертификаты соответствия на поставляемую продукцию (по желанию клиента).
- Тестирование поставляемой продукции.
- Поставку компонентов, требующих военную и космическую приемку.
- Входной контроль качества.
- Наличие сертификата ISO.

В составе нашей компании организован Конструкторский отдел, призванный помогать разработчикам, и инженерам.

Конструкторский отдел помогает осуществить:

- Регистрацию проекта у производителя компонентов.
- Техническую поддержку проекта.
- Защиту от снятия компонента с производства.
- Оценку стоимости проекта по компонентам.
- Изготовление тестовой платы монтаж и пусконаладочные работы.



Тел: +7 (812) 336 43 04 (многоканальный)

Email: org@lifeelectronics.ru