

FEATURES

- **Gain-Bandwidth: 150MHz**
- **Gain of 4 Stable**
- **Slew Rate: 250V/ μ s**
- Input Noise Voltage: $6nV/\sqrt{Hz}$
- C-Load™ Op Amp Drives Capacitive Loads
- Maximum Input Offset Voltage: 600 μ V
- Maximum Input Bias Current: 300nA
- Maximum Input Offset Current: 300nA
- Minimum Output Swing Into 500 Ω : $\pm 12V$
- Minimum DC Gain: 50V/mV, $R_L = 500\Omega$
- Settling Time to 0.1%: 65ns, 10V Step
- Settling Time to 0.01%: 85ns, 10V Step
- Differential Gain: 0.08%, $A_V = 4$, $R_L = 150\Omega$
- Differential Phase: 0.2°, $A_V = 4$, $R_L = 150\Omega$

APPLICATIONS

- Wideband Amplifiers
- Buffers
- Active Filters
- Video and RF Amplification
- Cable Drivers
- 8-, 10-, 12-Bit Data Acquisition Systems

DESCRIPTION

The LT[®]1221 is a very high speed operational amplifier with superior DC performance. The LT1221 is stable in a noise gain of 4 or greater. It features reduced input offset voltage, lower input bias currents and higher DC gain than devices with comparable bandwidth and slew rate. The circuit is a single gain stage that includes proprietary DC gain enhancement circuitry to obtain precision with high speed. The high gain and fast settling time make the circuit an ideal choice for data acquisition systems. The circuit is also capable of driving capacitive loads which makes it useful in buffer or cable driver applications.

The LT1221 is a member of a family of fast, high performance amplifiers that employ Linear Technology Corporation's advanced complementary bipolar processing. For unity-gain stable applications the LT1220 can be used, and for gains of 10 or greater the LT1222 can be used.

 LTC and LT are registered trademarks of Linear Technology Corporation
 C-Load is a trademark of Linear Technology Corporation

TYPICAL APPLICATION

Summing Amplifier

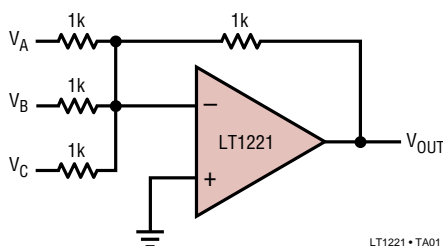

Summing Amplifier Large-Signal Response

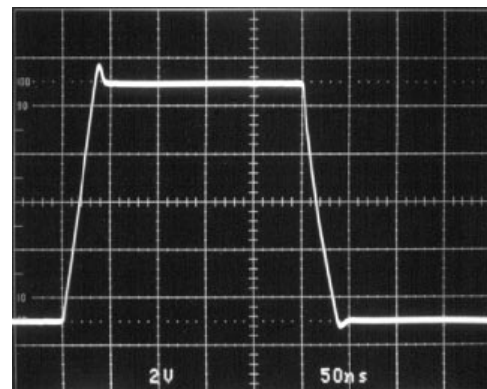

$V_S = \pm 15V$ $f = 2MHz$
 $V_{IN} = 10V_{P-P}$

LT1221 • TA02

LT1221

ABSOLUTE MAXIMUM RATINGS (Note 1)

| | |
|---|----------------|
| Total Supply Voltage (V^+ to V^-) | 36V |
| Differential Input Voltage | $\pm 6V$ |
| Input Voltage | $\pm V_S$ |
| Output Short-Circuit Duration (Note 2) | Indefinite |
| Specified Temperature Range | |
| LT1221C (Note 3) | 0°C to 70°C |
| LT1221M (OBSOLETE) | -55°C to 125°C |

| | |
|--|----------------|
| Operating Temperature Range | |
| LT1221C | -40°C TO 85°C |
| LT1221M (OBSOLETE) | -55°C to 125°C |
| Maximum Junction Temperature (See Below) | |
| Plastic Package | 150°C |
| Ceramic Package (OBSOLETE) | 175°C |
| Storage Temperature Range | -65°C to 150°C |
| Lead Temperature (Soldering, 10 sec) | 300°C |

PACKAGE/ORDER INFORMATION

| | | | |
|--|-------------------------------|--|-------------------|
| <p>TOP VIEW NULL 1 8 2 7 V+ -IN 3 6 VOUT +IN 4 5 NC V- H PACKAGE 8-LEAD TO-5 METAL CAN $T_{JMAX} = 175^\circ\text{C}$, $\theta_{JA} = 150^\circ\text{C/W}$</p> | ORDER PART NUMBER | <p>TOP VIEW 1 8 NULL 2 7 V+ -IN 3 6 VOUT +IN 4 5 NC V- N8 PACKAGE 8-LEAD PLASTIC DIP $T_{JMAX} = 150^\circ\text{C}$, $\theta_{JA} = 130^\circ\text{C/W}$ (N) $T_{JMAX} = 150^\circ\text{C}$, $\theta_{JA} = 190^\circ\text{C/W}$ (S)</p> | ORDER PART NUMBER |
| | SPECIAL ORDER CONSULT FACTORY | | ORDER PART NUMBER |
| <p>OBSOLETE PACKAGE Consider the N8 or S8 Package for Alternate Source</p> | | <p>S8 PACKAGE 8-LEAD PLASTIC SOIC $T_{JMAX} = 150^\circ\text{C}$, $\theta_{JA} = 190^\circ\text{C/W}$ (S)</p> | S8 PART MARKING |
| | | | ORDER PART NUMBER |
| | | <p>J8 PACKAGE 8-LEAD CERAMIC DIP $T_{JMAX} = 175^\circ\text{C}$, $\theta_{JA} = 100^\circ\text{C/W}$ (J)</p> | 1221 |
| | | <p>OBSOLETE PACKAGE Consider the N8 Package for Alternate Source</p> | ORDER PART NUMBER |
| | | | LT1221MJ8 |

Consult LTC Marketing for parts specified with wider operating temperature ranges.

ELECTRICAL CHARACTERISTICS

$T_A = 25^\circ\text{C}$, $V_S = \pm 15V$, $T_A = 25^\circ\text{C}$, $V_{CM} = 0V$, unless otherwise specified.

| SYMBOL | PARAMETER | CONDITIONS | MIN | TYP | MAX | UNITS |
|-----------|--------------------------------|---|-----|----------|-----|--------------------------------------|
| V_{OS} | Input Offset Voltage | (Note 4) | | 200 | 600 | μV |
| I_{OS} | Input Offset Current | | | 100 | 300 | nA |
| I_B | Input Bias Current | | | 100 | 300 | nA |
| e_n | Input Noise Voltage | $f = 10\text{kHz}$ | | 6 | | $\text{nV}/\sqrt{\text{Hz}}$ |
| i_n | Input Noise Current | $f = 10\text{kHz}$ | | 2 | | $\text{pA}/\sqrt{\text{Hz}}$ |
| R_{IN} | Input Resistance | $V_{CM} = \pm 12V$ Differential | 20 | 45 80 | | $\text{M}\Omega$ $\text{k}\Omega$ |
| C_{IN} | Input Capacitance | | | 2 | | pF |
| | Input Voltage Range (Positive) | | 12 | 14 | | V |
| | Input Voltage Range (Negative) | | | -13 | -12 | V |
| CMRR | Common Mode Rejection Ratio | $V_{CM} = \pm 12V$ | 92 | 114 | | dB |
| PSRR | Power Supply Rejection Ratio | $V_S = \pm 5V$ to $\pm 15V$ | 90 | 110 | | dB |
| A_{VOL} | Large-Signal Voltage Gain | $V_{OUT} = \pm 10V$, $R_L = 500\Omega$ | 50 | 100 | | V/mV |
| V_{OUT} | Output Swing | $R_L = 500\Omega$ | 12 | 13 | | $\pm V$ |
| I_{OUT} | Output Current | $V_{OUT} = \pm 12V$ | 24 | 26 | | mA |
| SR | Slew Rate | (Note 5) | 200 | 250 | | V/ μs |
| | Full Power Bandwidth | 10V Peak (Note 6) | | 4 | | MHz |
| GBW | Gain-Bandwidth | $f = 1\text{MHz}$ | | 150 | | MHz |

ELECTRICAL CHARACTERISTICS $V_S = \pm 15V$, $T_A = 25^\circ C$, $V_{CM} = 0V$, unless otherwise specified.

| SYMBOL | PARAMETER | CONDITIONS | MIN | TYP | MAX | UNITS |
|------------|----------------------|--|-----|------|------|----------|
| t_r, t_f | Rise Time, Fall Time | $A_V = 4$, 10% to 90%, 0.1V | | 3.2 | | ns |
| | Overshoot | $A_V = 4$, 0.1V | | 10 | | % |
| | Propagation Delay | $A_V = 4$, 50% V_{IN} to 50% V_{OUT} , 0.1V | | 5.4 | | ns |
| t_s | Settling Time | 10V Step, 0.1% | | 65 | | ns |
| | | 10V Step, 0.01% | | 85 | | ns |
| | Differential Gain | $f = 3.58MHz$, $R_L = 150\Omega$ (Note 7) | | 0.08 | | % |
| | | $f = 3.58MHz$, $R_L = 1k$ (Note 7) | | 0.02 | | % |
| | Differential Phase | $f = 3.58MHz$, $R_L = 150\Omega$ (Note 7) | | 0.20 | | DEG |
| | | $f = 3.58MHz$, $R_L = 1k$ (Note 7) | | 0.05 | | DEG |
| R_O | Output Resistance | $A_V = 4$, $f = 1MHz$ | | 0.3 | | Ω |
| I_S | Supply Current | | | 8 | 10.5 | mA |

The ● denotes the specifications which apply over the temperature range $0^\circ C \leq T_A \leq 70^\circ C$, otherwise specifications are at $T_A = 25^\circ C$. $V_S = \pm 15V$, $V_{CM} = 0V$, unless otherwise specified.

| SYMBOL | PARAMETER | CONDITIONS | MIN | TYP | MAX | UNITS |
|-----------|------------------------------|---|-----|-----|-----|------------------|
| V_{OS} | Input Offset Voltage | (Note 4) | ● | 0.2 | 1.5 | mV |
| | Input V_{OS} Drift | | ● | 15 | | $\mu V/^\circ C$ |
| I_{OS} | Input Offset Current | | ● | 100 | 400 | nA |
| I_B | Input Bias Current | | ● | 100 | 400 | nA |
| CMRR | Common Mode Rejection Ratio | $V_{CM} = \pm 12V$ | ● | 92 | 114 | dB |
| PSRR | Power Supply Rejection Ratio | $V_S = \pm 5V$ to $\pm 15V$ | ● | 90 | 110 | dB |
| A_{VOL} | Large-Signal Voltage Gain | $V_{OUT} = \pm 10V$, $R_L = 500\Omega$ | ● | 40 | 100 | V/mV |
| V_{OUT} | Output Swing | $R_L = 500\Omega$ | ● | 12 | 13 | $\pm V$ |
| I_{OUT} | Output Current | $V_{OUT} = \pm 12V$ | ● | 24 | 26 | mA |
| SR | Slew Rate | (Note 5) | ● | 180 | 250 | V/ μs |
| I_S | Supply Current | | ● | 8 | 11 | mA |

The ● denotes the specifications which apply over the temperature range $-55^\circ C \leq T_A \leq 125^\circ C$, otherwise specifications are at $T_A = 25^\circ C$. $V_S = \pm 15V$, $V_{CM} = 0V$, unless otherwise specified.

| SYMBOL | PARAMETER | CONDITIONS | MIN | TYP | MAX | UNITS |
|-----------|------------------------------|---|-----|------|------|------------------|
| V_{OS} | Input Offset Voltage | (Note 4) | ● | 0.2 | 2 | mV |
| | Input V_{OS} Drift | | ● | 15 | | $\mu V/^\circ C$ |
| I_{OS} | Input Offset Current | | ● | 100 | 800 | nA |
| I_B | Input Bias Current | | ● | 100 | 1000 | nA |
| CMRR | Common Mode Rejection Ratio | $V_{CM} = \pm 12V$ | ● | 92 | 114 | dB |
| PSRR | Power Supply Rejection Ratio | $V_S = \pm 5V$ to $\pm 15V$ | ● | 90 | 110 | dB |
| A_{VOL} | Large-Signal Voltage Gain | $V_{OUT} = \pm 10V$, $R_L = 500\Omega$ | ● | 12.5 | 100 | V/mV |
| V_{OUT} | Output Swing | $R_L = 500\Omega$ | ● | 10 | 13 | $\pm V$ |
| | | $R_L = 1k$ | ● | 12 | 13 | $\pm V$ |
| I_{OUT} | Output Current | $V_{OUT} = \pm 10V$ | ● | 20 | 26 | mA |
| | | $V_{OUT} = \pm 12V$ | ● | 12 | 13 | mA |
| SR | Slew Rate | (Note 5) | ● | 130 | 250 | V/ μs |
| I_S | Supply Current | | ● | 8 | 11 | mA |

Note 1: Absolute Maximum Ratings are those values beyond which the life of a device may be impaired.

Note 2: A heat sink may be required when the output is shorted indefinitely.

Note 3: Commercial parts are designed to operate over $-40^\circ C$ to $85^\circ C$, but are not tested nor guaranteed beyond $0^\circ C$ to $70^\circ C$. Industrial grade parts specified and tested over $-40^\circ C$ to $85^\circ C$ are available on special request. Consult factory.

Note 4: Input offset voltage is pulse tested and is exclusive of warm-up drift.

Note 5: Slew rate is measured between $\pm 10V$ on an output swing of $\pm 12V$.

Note 6: $FPBW = SR/2\pi V_p$.

Note 7: Differential Gain and Phase are tested in $A_V = 4$ with five amps in series. Attenuators of 1/4 are used as loads (36.5Ω , 110Ω and 249Ω , 750Ω).

TYPICAL PERFORMANCE CHARACTERISTICS

Input Common Mode Range vs Supply Voltage

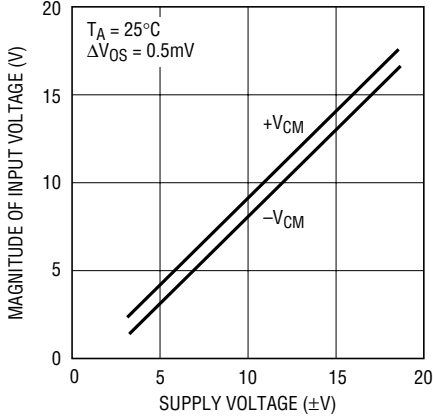

LT1221 • TPC01

Supply Current vs Supply Voltage and Temperature

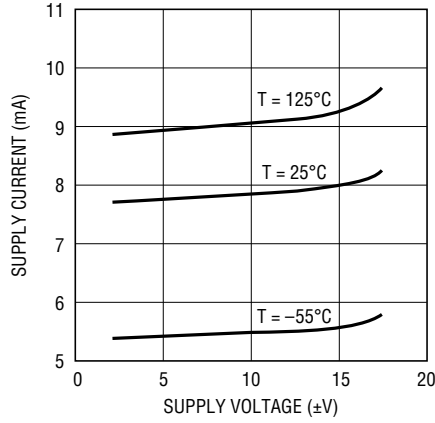

LT1221 • TPC02

Output Voltage Swing vs Supply Voltage

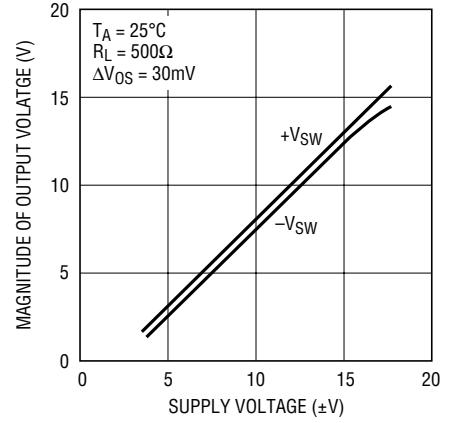

LT1221 • TPC03

Output Voltage Swing vs Resistive Load

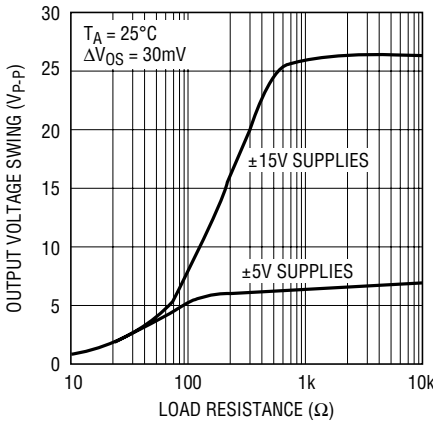

LT1221 • TPC04

Input Bias Current vs Input Common Mode Voltage

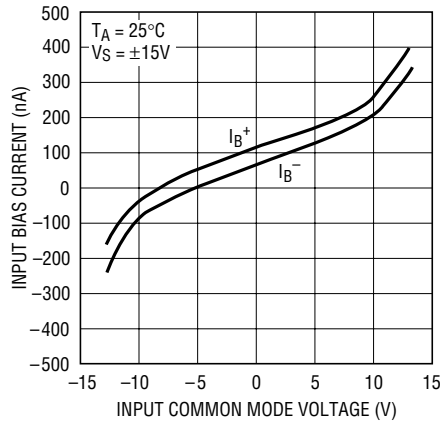

LT1221 • TPC05

Open-Loop Gain vs Resistive Load

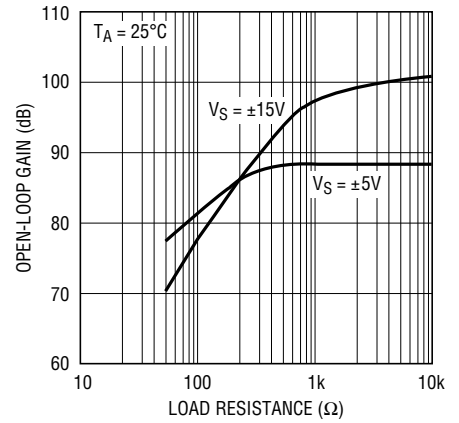

LT1221 • TPC06

Output Short-Circuit Current vs Temperature

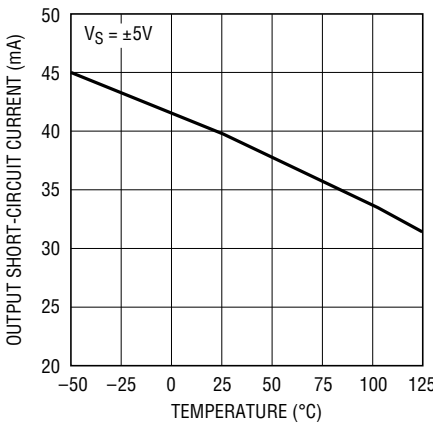

LT1221 • TPC07

Input Noise Spectral Density

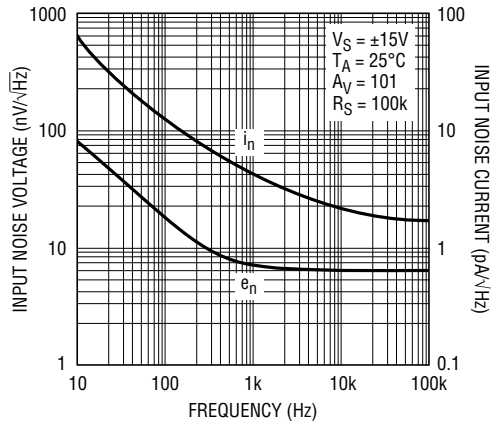

LT1221 • TPC08

Power Supply Rejection Ratio vs Frequency

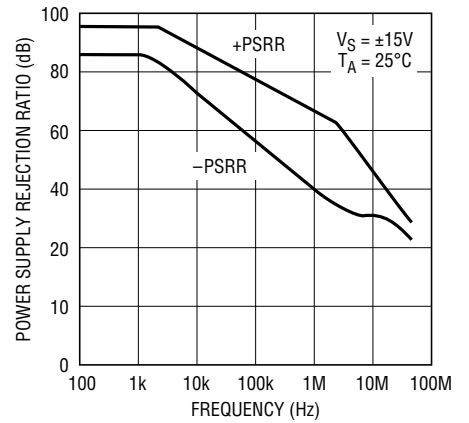

LT1221 • TPC09

TYPICAL PERFORMANCE CHARACTERISTICS

Common Mode Rejection Ratio vs Frequency

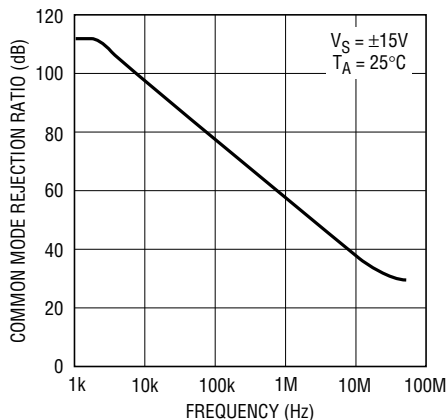

LT1221 • TPC10

Output Swing and Error vs Settling Time (Noninverting)

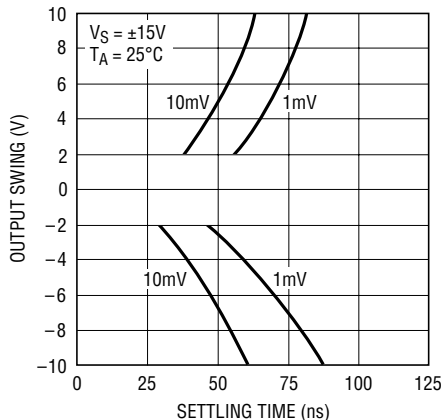

LT1220 • TPC11

Output Swing and Error vs Settling Time (Inverting)

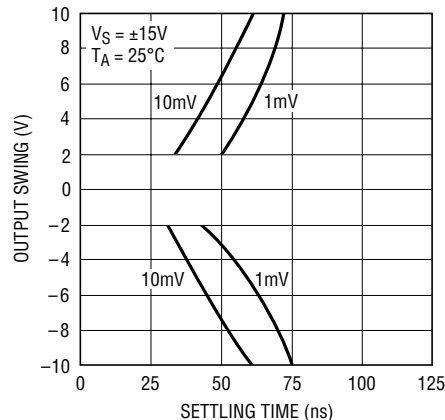

LT1221 • TPC12

Voltage Gain and Phase vs Frequency

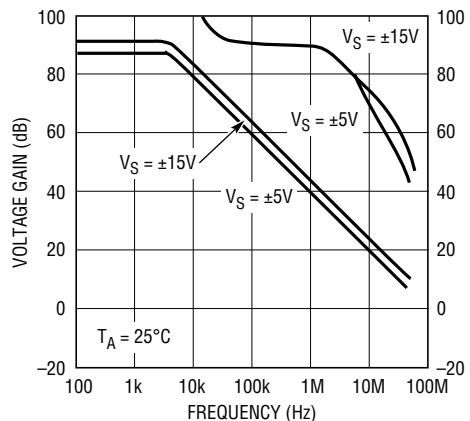

LT1221 • TPC13

Frequency Response vs Capacitive Load

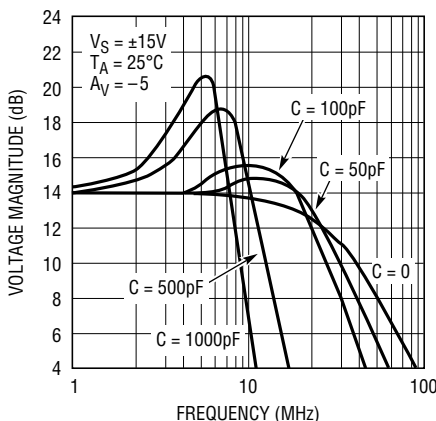

LT1221 • TPC14

Closed-Loop Output Impedance vs Frequency

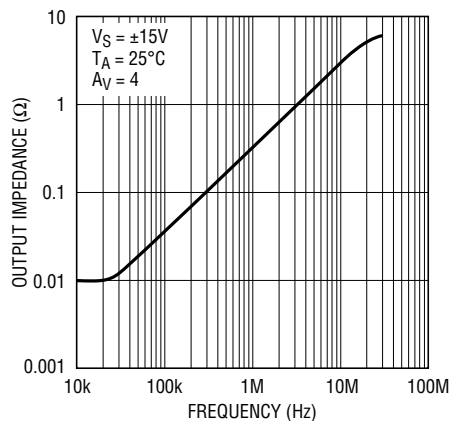

LT1221 • TPC15

Gain-Bandwidth vs Temperature

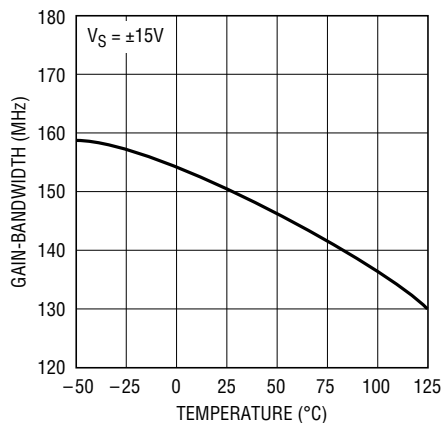

LT1221 • TPC16

Slew Rate vs Temperature

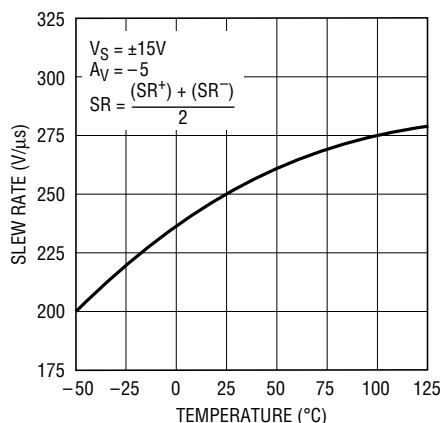

LT1221 • TPC19

Total Harmonic Distortion vs Frequency

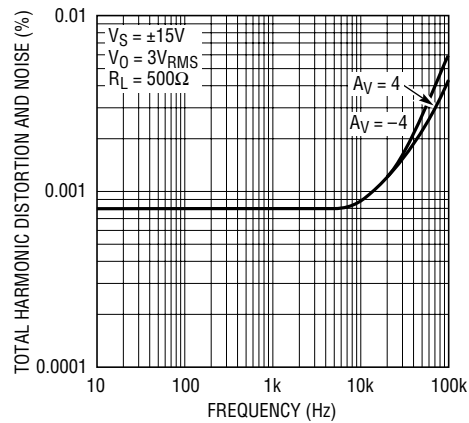

LT1220 • TPC18

TYPICAL PERFORMANCE CHARACTERISTICS

Small Signal, $A_V = 4$

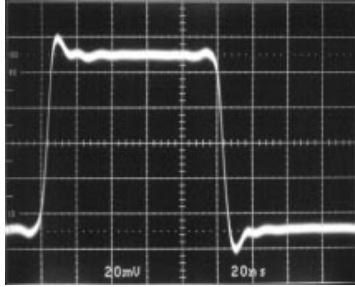

$V_S = \pm 15V$ $f = 5MHz$ $V_{IN} = 25mV$ LT1221 • TPC19

Large Signal, $A_V = 4$

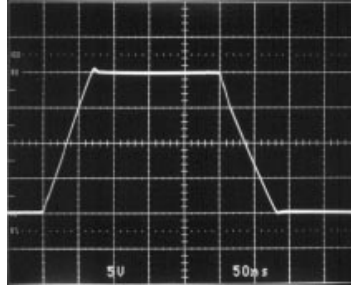

$V_S = \pm 15V$ $f = 2MHz$ $V_{IN} = 5V_{p-p}$ LT1221 • TPC20

Large Signal, $A_V = 4$,
 $C_L = 10,000pF$

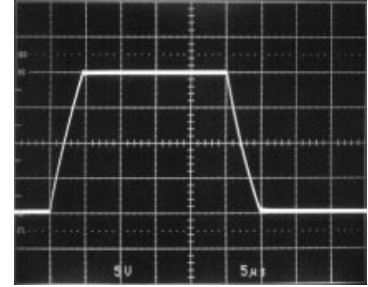

$V_S = \pm 15V$ $f = 20kHz$ $V_{IN} = 5V_{p-p}$ LT1221 • TPC21

Small Signal, $A_V = -4$

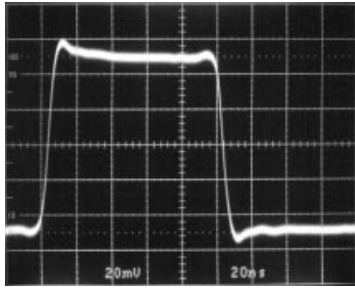

$V_S = \pm 15V$ $f = 5MHz$ $V_{IN} = 25mV$ LT1221 • TPC22

Large Signal, $A_V = -4$

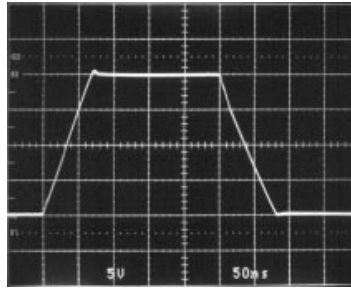

$V_S = \pm 15V$ $f = 2MHz$ $V_{IN} = 5V_{p-p}$ LT1221 • TPC23

Small Signal, $A_V = -4$,
 $C_L = 1,000pF$

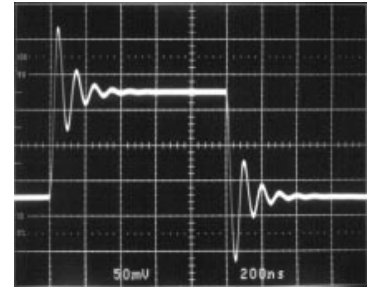

$V_S = \pm 15V$ $f = 500kHz$ $V_{IN} = 42mV$ LT1221 • TPC24

APPLICATIONS INFORMATION

The LT1221 is stable in noise gains of 4 or greater and may be inserted directly into HA2520/2/5, HA2541/2/4, AD817, AD847, EL2020, EL2044 and LM6361 applications, provided that the nulling circuitry is removed and the amplifier configuration has a high enough noise gain. The suggested nulling circuit for the LT1221 is shown in the following figure.

Offset Nulling

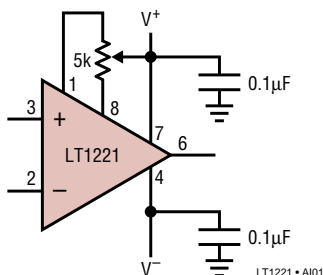

LT1221 • AI01

Layout and Passive Components

The LT1221 amplifier is easy to apply and tolerant of less than ideal layouts. For maximum performance (for example, fast settling time) use a ground plane, short lead lengths and RF-quality bypass capacitors (0.01µF to 0.1µF). For high drive current applications use low ESR bypass capacitors (1µF to 10µF tantalum). Sockets should be avoided when maximum frequency performance is required, although low profile sockets can provide reasonable performance up to 50MHz. For more details see Design Note 50. Feedback resistors greater than 5k are not recommended because a pole is formed with the input capacitance which can cause peaking or oscillations.

Input Considerations

Bias current cancellation circuitry is employed on the inputs of the LT1221 so the input bias current and input

APPLICATIONS INFORMATION

offset current have identical specifications. For this reason, matching the impedance on the inputs to reduce bias current errors is not necessary.

Capacitive Loading

The LT1221 is stable with capacitive loads. This is accomplished by sensing the load induced output pole and adding compensation at the amplifier gain node. As the capacitive load increases, both the bandwidth and phase margin decrease. There will be peaking in the frequency domain as shown in the curve of Frequency Response vs Capacitive Load. The small-signal transient response will have more overshoot as shown in the photo of the small-signal response with 1000pF load. The large-signal response with a 10,000pF load shows the output slew rate being limited to $4V/\mu s$ by the short-circuit current. The LT1221 can drive coaxial cable directly, but for best pulse fidelity a resistor of value equal to the characteristic impedance of the cable (i.e., 75Ω) should be placed in series with the output. The other end of the cable should be terminated with the same value resistor to ground.

Compensation

The LT1221 has a typical gain-bandwidth product of 150MHz which allows it to have wide bandwidth in high gain configurations (i.e., in a gain of 10, it will have a bandwidth of about 15MHz). The amplifier is stable in a noise gain of 4 so the ratio of the signal at the inverting input to the output must be $1/4$ or less. Straightforward gain configurations of 4 or -3 are stable, but there are several others that allow the amplifier to be stable for lower signal gains (the noise gain, however, remains 4 or more). One example is the summing amplifier on the first page of this data sheet. Each input signal has a gain of -1 to the output, but it is easily seen that this configuration is equivalent to a gain of -3 as far as the amplifier is concerned. Another circuit is shown below with a DC gain of 1, but an AC gain of 5. The break frequency of the R-C combination across the amplifier inputs should be approximately a factor of 10 less than the gain-bandwidth of the amplifier divided by the high frequency gain (in this case $1/10$ of $150MHz/5$ or 3MHz).

SIMPLIFIED SCHEMATIC

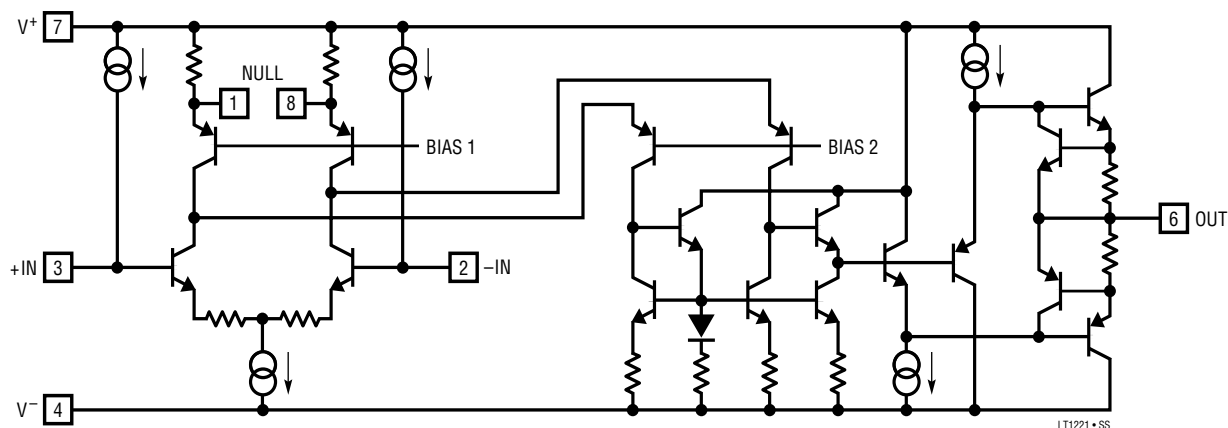

PACKAGE DESCRIPTION

H Package
8-Lead TO-5 Metal Can (.200 Inch PCD)
 (Reference LTC DWG # 05-08-1320)

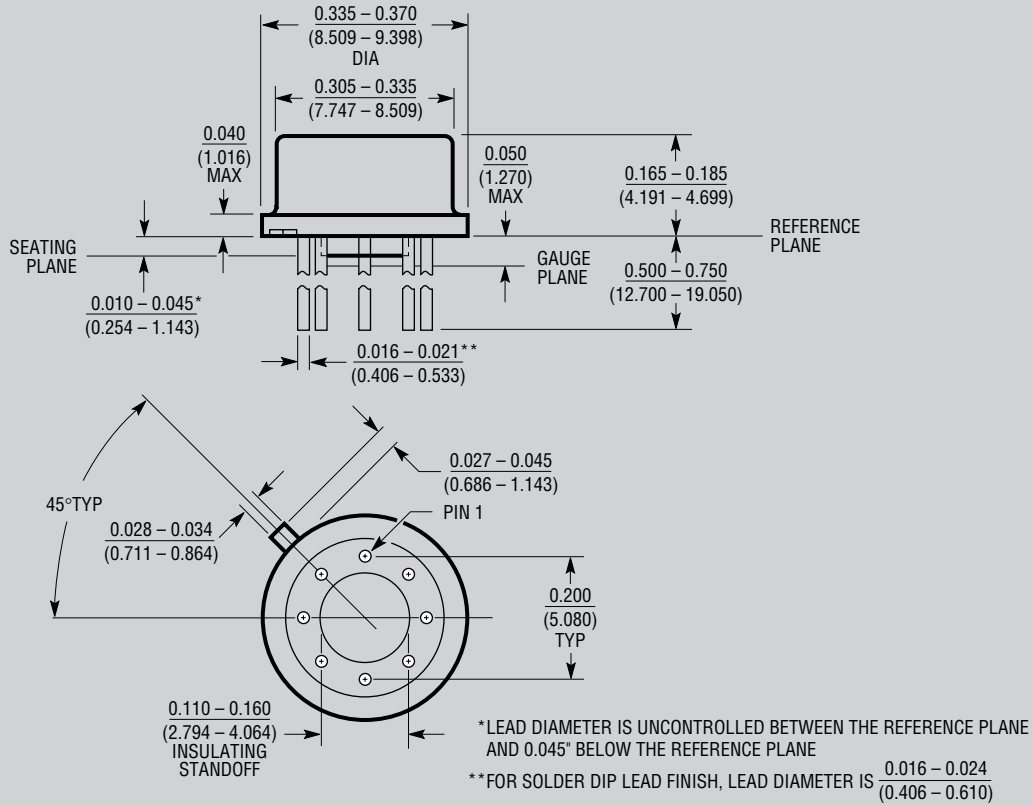

H8(TO-5) 0.200 PCD 1197

OBsolete PACKAGE

PACKAGE DESCRIPTION

J8 Package
8-Lead CERDIP (Narrow .300 Inch, Hermetic)
 (Reference LTC DWG # 05-08-1110)

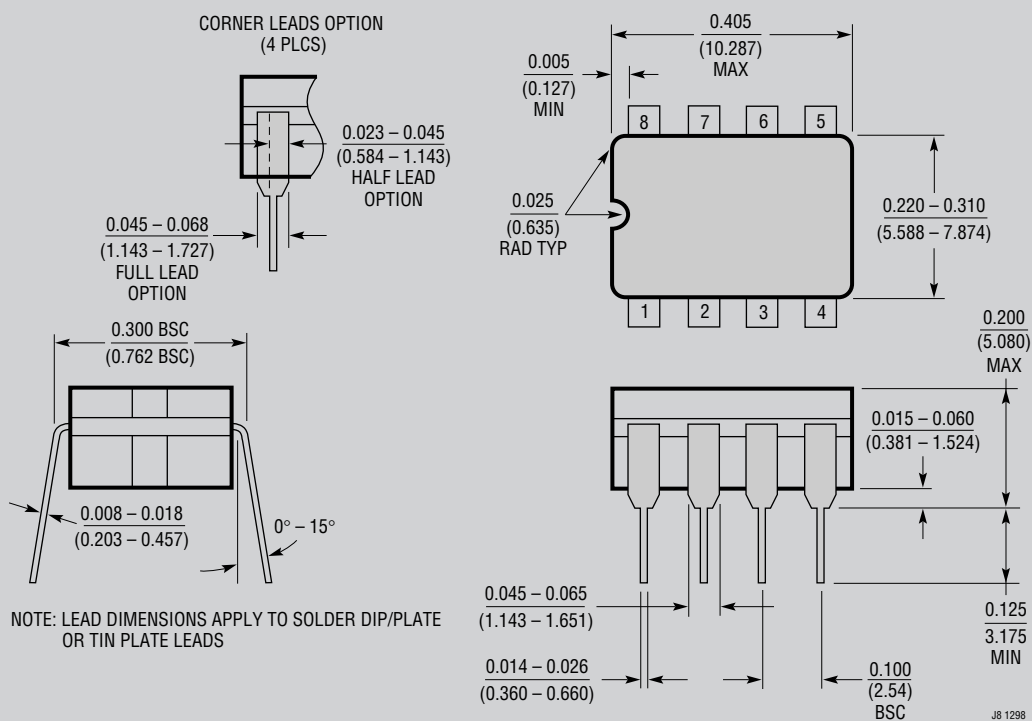

OBsolete PACKAGE

PACKAGE DESCRIPTION

N8 Package
8-Lead PDIP (Narrow .300 Inch)
 (Reference LTC DWG # 05-08-1510)

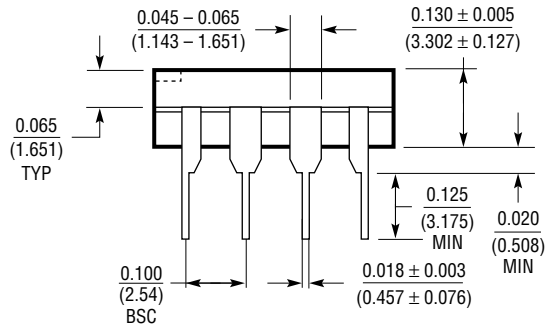
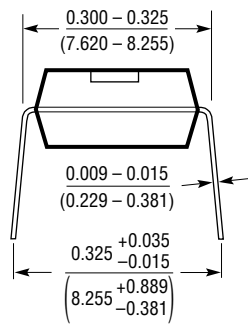
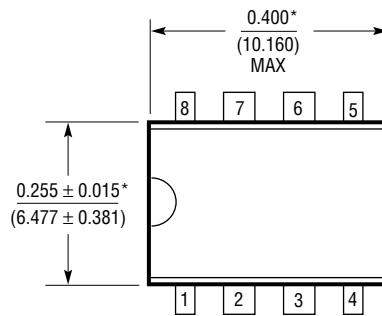

*THESE DIMENSIONS DO NOT INCLUDE MOLD FLASH OR PROTRUSIONS.
 MOLD FLASH OR PROTRUSIONS SHALL NOT EXCEED 0.010 INCH (0.254mm)

N8 1098

PACKAGE DESCRIPTION

S8 Package
8-Lead Plastic Small Outline (Narrow .150 Inch)
 (Reference LTC DWG # 05-08-1610)

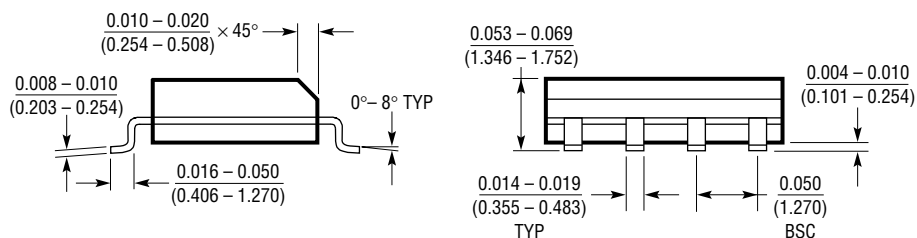
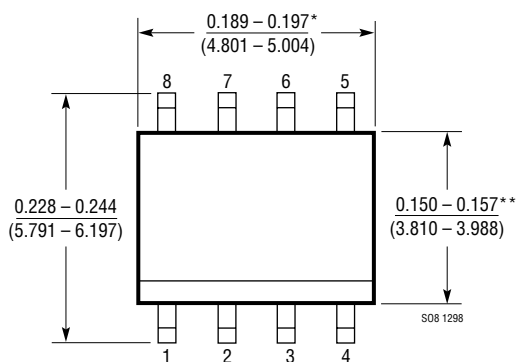

*DIMENSION DOES NOT INCLUDE MOLD FLASH. MOLD FLASH SHALL NOT EXCEED 0.006" (0.152mm) PER SIDE

**DIMENSION DOES NOT INCLUDE INTERLEAD FLASH. INTERLEAD FLASH SHALL NOT EXCEED 0.010" (0.254mm) PER SIDE

TYPICAL APPLICATIONS

20MHz, $A_V = 50$ Instrumentation Amplifier

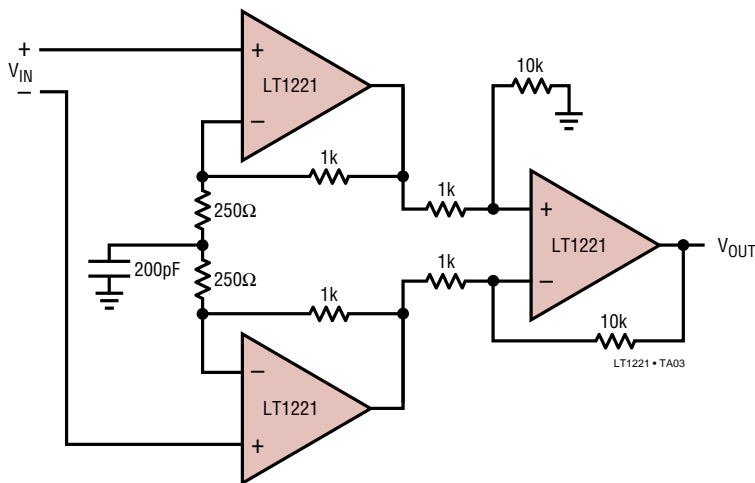

Lag Compensation

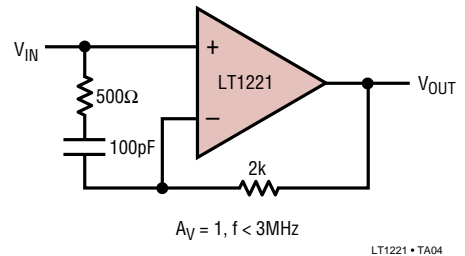

Cable Driver

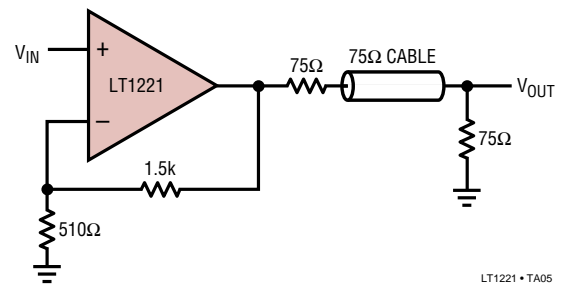

RELATED PARTS

| PART NUMBER | DESCRIPTION | COMMENTS |
|-------------|---------------------------------------|---|
| LT1220 | 45MHz, 250V/ μs Amplifier | Unity Gain Stable Version of the LT1221 |
| LT1222 | 500MHz, 200V/ μs Amplifier | $A_V \geq 10$ Version of the LT1221 |

Компания «Life Electronics» занимается поставками электронных компонентов импортного и отечественного производства от производителей и со складов крупных дистрибьюторов Европы, Америки и Азии.

С конца 2013 года компания активно расширяет линейку поставок компонентов по направлению коаксиальный кабель, кварцевые генераторы и конденсаторы (керамические, пленочные, электролитические), за счёт заключения дистрибьюторских договоров

Мы предлагаем:

- Конкурентоспособные цены и скидки постоянным клиентам.
- Специальные условия для постоянных клиентов.
- Подбор аналогов.
- Поставку компонентов в любых объемах, удовлетворяющих вашим потребностям.
- Приемлемые сроки поставки, возможна ускоренная поставка.
- Доставку товара в любую точку России и стран СНГ.
- Комплексную поставку.
- Работу по проектам и поставку образцов.
- Формирование склада под заказчика.
- Сертификаты соответствия на поставляемую продукцию (по желанию клиента).
- Тестирование поставляемой продукции.
- Поставку компонентов, требующих военную и космическую приемку.
- Входной контроль качества.
- Наличие сертификата ISO.

В составе нашей компании организован Конструкторский отдел, призванный помогать разработчикам, и инженерам.

Конструкторский отдел помогает осуществить:

- Регистрацию проекта у производителя компонентов.
- Техническую поддержку проекта.
- Защиту от снятия компонента с производства.
- Оценку стоимости проекта по компонентам.
- Изготовление тестовой платы монтаж и пусконаладочные работы.



Тел: +7 (812) 336 43 04 (многоканальный)

Email: org@lifeelectronics.ru