

# 7SB385

## Bus Switch

The 7SB385 Bus Switch is an advanced high-speed line switch in ultra-small footprint.

### Features

- High Speed:  $t_{PD} = 0.25 \text{ ns (Max) @ } V_{CC} = 4.5 \text{ V}$
- $3 \Omega$  Switch Connection Between 2 Ports
- Power Down Protection Provided on Inputs
- Ultra-Small Packages
- These are Pb-Free Devices

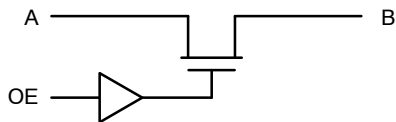

Figure 1. Logic Diagram

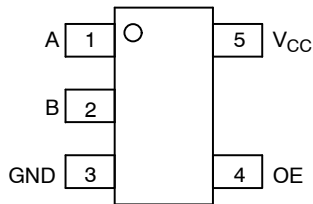

Figure 2. TSOP-5/SC-88A (Top View)

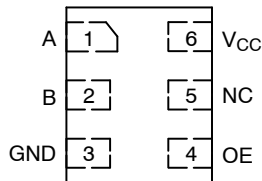

Figure 3. ULLGA6/UDFN6 (Top View)

### Function Table

| Input OE | Function   |
|----------|------------|
| L        | Disconnect |
| H        | B = A      |



ON Semiconductor®

<http://onsemi.com>

### MARKING DIAGRAMS

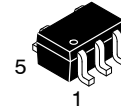

SOT-353/SC70-5/SC-88A  
DF SUFFIX  
CASE 419A

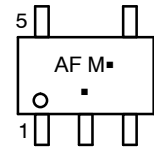

SOT23-5/TSOP-5/SC59-5  
DT SUFFIX  
CASE 483

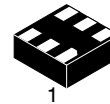
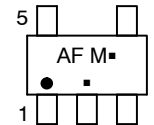

ULLGA6  
1.0 x 1.0  
CASE 613AD

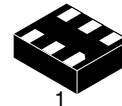

ULLGA6  
1.2 x 1.0  
CASE 613AE

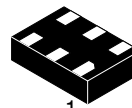

ULLGA6  
1.45 x 1.0  
CASE 613AF

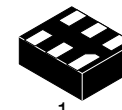

UDFN6  
1.2 x 1.0  
CASE 517AA



AF, 4, V, J, F = Specific Device Code  
M = Date Code  
▪ = Pb-Free Package

(Note: Microdot may be in either location)

### ORDERING INFORMATION

See detailed ordering and shipping information in the package dimensions section on page 4 of this data sheet.

**Table 1. MAXIMUM RATINGS**

| Symbol        | Parameter   | Value   | Unit                               |
|---------------|---|---|------------------------------------|
| $V_{CC}$      | DC Supply Voltage   | -0.5 to +7.0  | V                                  |
| $V_{IN}$      | Control Pin Input Voltage   | -0.5 to +7.0  | V                                  |
| $V_{I/O}$     | Switch Input / Output Voltage   | -0.5 to +7.0  | V                                  |
| $I_{IK}$      | Control Pin DC Input Diode Current<br>$V_{IN} < GND$                        | -50   | mA                                 |
| $I_{OK}$      | Switch I/O Port DC Diode Current<br>$V_{I/O} < GND$                         | -50   | mA                                 |
| $I_O$         | On-State Switch Current   | $\pm 128$   | mA                                 |
|               | Continuous Current Through $V_{CC}$ or GND                                  | $\pm 150$   | mA                                 |
| $I_{CC}$      | DC Supply Current per Supply Pin  | $\pm 150$   | mA                                 |
| $I_{GND}$     | DC Ground Current per Ground Pin  | $\pm 150$   | mA                                 |
| $T_{STG}$     | Storage Temperature Range   | -65 to +150   | $^{\circ}C$                        |
| $T_L$         | Lead Temperature, 1 mm from Case for 10 Seconds                             | 260   | $^{\circ}C$                        |
| $T_J$         | Junction Temperature Under Bias   | 150   | $^{\circ}C$                        |
| $\theta_{JA}$ | Thermal Resistance  | SC70-5/SC-88A (Note 1)<br>TSOP-5<br>ULLGA6/UDFN6                                  | 350<br>230<br>496<br>$^{\circ}C/W$ |
| $P_D$         | Power Dissipation in Still Air at 85 $^{\circ}C$                            | SC70-5/SC-88A (Note 1)<br>TSOP-5<br>ULLGA6/UDFN6                                  | 150<br>200<br>252<br>mW            |
| MSL           | Moisture Sensitivity  | Level 1   |                                    |
| $F_R$         | Flammability Rating   | Oxygen Index: 28 to 34  | UL 94 V-0 @ 0.125 in               |
| $V_{ESD}$     | ESD Withstand Voltage   | Human Body Mode (Note 2)<br>Machine Mode (Note 3)<br>Charged Device Mode (Note 4) | >2000<br>>200<br>N/A<br>V          |
| $I_{LATCHUP}$ | Latchup Performance Above $V_{CC}$ and Below GND at 85 $^{\circ}C$ (Note 5) | $\pm 100$   | mA                                 |

Stresses exceeding Maximum Ratings may damage the device. Maximum Ratings are stress ratings only. Functional operation above the Recommended Operating Conditions is not implied. Extended exposure to stresses above the Recommended Operating Conditions may affect device reliability.

1. Measured with minimum pad spacing on an FR4 board, using 10 mm-by-1 inch, 2 ounce copper trace no air flow.
2. Tested to EIA/ JESD22-A114-A
3. Tested to EIA/ JESD22-A115-A
4. Tested to JESD22-C101-A
5. Tested to EIA / JESD78.

**Table 2. RECOMMENDED OPERATING CONDITIONS**

| Symbol                | Parameter                          | Min           | Max     | Unit        |
|-----------------------|------------------------------------|---------------|---------|-------------|
| $V_{CC}$              | Positive DC Supply Voltage         | 4.0           | 5.5     | V           |
| $V_I$                 | Control Pin Input Voltage          | 0             | 5.5     | V           |
| $V_{I/O}$             | Switch Input / Output Voltage      | 0             | 5.5     | V           |
| $T_A$                 | Operating Free-Air Temperature     | -55           | +125    | $^{\circ}C$ |
| $\Delta t / \Delta V$ | Input Transition Rise or Fall Rate | 0<br>0        | 5<br>DC | nS/V        |
|                       |                                    | Control Input |         |             |
|                       |                                    | Switch I/O    |         |             |

Table 3. DC ELECTRICAL CHARACTERISTICS

| Symbol           | Parameter                                | Conditions  | V <sub>CC</sub> (V) | T <sub>A</sub> = 25°C |        |        | T <sub>A</sub> = -55°C to +125°C |        | Unit |
|------------------|--|---|---------------------|-----------------------|--------|--------|----------------------------------|--------|------|
|                  |  |   |                     | Min                   | Typ    | Max    | Min                              | Max    |      |
| V <sub>IK</sub>  | Clamp Diode Voltage                      | I <sub>IN</sub> = -18 mA  | 4.5                 |                       |        | -1.2   |                                  | -1.2   | V    |
| V <sub>IH</sub>  | High-Level Input Voltage (Control)       |   | 4.0 to 5.5          | 2.0                   |        |        | 2.0                              |        | V    |
| V <sub>IL</sub>  | Low-Level Input Voltage (Control)        |   | 4.0 to 5.5          |                       |        | 0.8    |                                  | 0.8    | V    |
| I <sub>IN</sub>  | Input Leakage Current                    | 0 ≤ V <sub>IN</sub> ≤ 5.5 V   | 5.5                 |                       |        | ±0.1   |                                  | ±1.0   | μA   |
| I <sub>OFF</sub> | Power Off Leakage Current                | V <sub>I/O</sub> = 0 to 5.5 V   | 0                   |                       |        | ±0.1   |                                  | ±1.0   | μA   |
| I <sub>CC</sub>  | Quiescent Supply Current                 | I <sub>O</sub> = 0, V <sub>IN</sub> = V <sub>CC</sub> or 0 V                  | 5.5                 |                       |        | ±0.1   |                                  | ±1.0   | μA   |
| ΔI <sub>CC</sub> | Increase in Supply Current (Control Pin) | One input at 3.4 V; Other inputs at V <sub>CC</sub> or GND                    | 5.5                 |                       |        |        |                                  | 2.5    | mA   |
| R <sub>ON</sub>  | Switch ON Resistance                     | V <sub>I/O</sub> = 0,<br>I <sub>I/O</sub> = 64 mA<br>I <sub>I/O</sub> = 30 mA | 4.5                 |                       | 3<br>3 | 7<br>7 |                                  | 7<br>7 | Ω    |
|                  |  | V <sub>I/O</sub> = 2.4,<br>I <sub>I/O</sub> = 15 mA                           | 4.5                 |                       | 6      | 15     |                                  | 15     |      |
|                  |  | V <sub>I/O</sub> = 2.4,<br>I <sub>I/O</sub> = 15 mA                           | 4.0                 |                       | 10     | 20     |                                  | 20     |      |

Table 4. AC ELECTRICAL CHARACTERISTICS

| Symbol               | Parameter                           | V <sub>CC</sub> (V) | Test Condition             | T <sub>A</sub> = 25°C |      |      | T <sub>A</sub> = -55°C to +125°C |      | Unit |
|----------------------|-------------------------------------|---------------------|----------------------------|-----------------------|------|------|----------------------------------|------|------|
|                      |                                     |                     |                            | Min                   | Typ  | Max  | Min                              | Max  |      |
| t <sub>PD</sub>      | Propagation Delay, A to B or B to A | 4.0 to 5.5          | See Figure 3               |                       |      | 0.25 |                                  | 0.25 | ns   |
|                      |                                     |                     |                            |                       | 0.25 |      | 0.25                             |      |      |
| t <sub>EN</sub>      | Output Enable Time                  | 4.5 to 5.5          |                            | 0.8                   | 2.5  | 4.2  | 0.8                              | 4.2  | ns   |
|                      |                                     | 4.0                 |                            | 0.8                   | 3.0  | 4.6  | 0.8                              | 4.6  |      |
| t <sub>DIS</sub>     | Output Disable Time                 | 4.5 to 5.5          |                            | 0.8                   | 3.1  | 4.8  | 0.8                              | 4.8  | ns   |
|                      |                                     | 4.0                 |                            | 0.8                   | 2.9  | 4.4  | 0.8                              | 4.4  |      |
| C <sub>IN</sub>      | Control Input Capacitance           | 5.0                 | V <sub>IN</sub> = 3 V or 0 |                       | 2.0  |      |                                  | pF   |      |
| C <sub>IO(ON)</sub>  | Switch On Capacitance               | 5.0                 | Switch ON                  |                       | 10   |      |                                  | pF   |      |
| C <sub>IO(OFF)</sub> | Switch Off Capacitance              | 5.0                 | Switch OFF                 |                       | 3.5  |      |                                  | pF   |      |

AC Loading and Waveforms

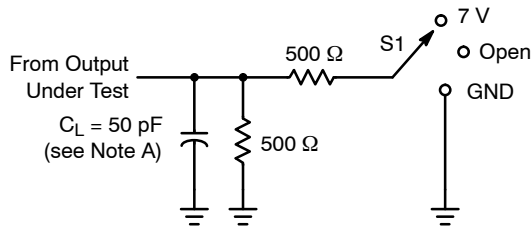

LOAD CIRCUIT

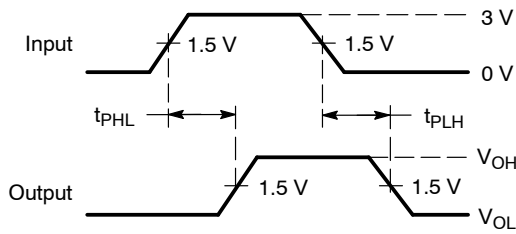

VOLTAGE WAVEFORMS PROPAGATION DELAY TIMES

| TEST              | S1   |
|-------------------|------|
| $t_{PD}$          | Open |
| $t_{PLZ}/t_{PZL}$ | 7 V  |
| $t_{PHZ}/t_{PZH}$ | GND  |

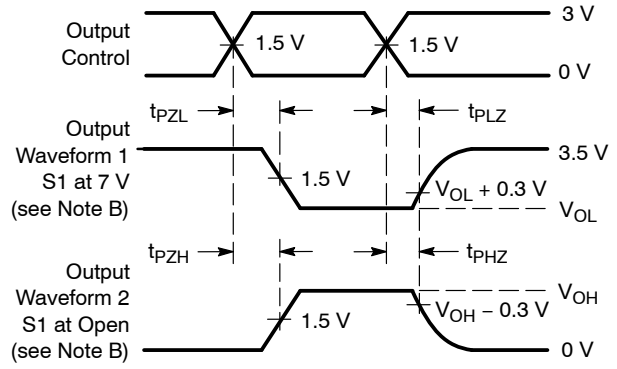

VOLTAGE WAVEFORMS ENABLE AND DISABLE TIMES

- A.  $C_L$  includes probe and jig capacitance.
- B. Waveform 1 is for an output with internal conditions such that the output is low, except when disabled by the output control. Waveform 2 is for an output with internal conditions such that the output is high, except when disabled by the output control.
- C. All input pulses are supplied by generators having the following characteristics: PRR  $\leq$  10 MHz,  $Z_O = 50 \Omega$ ,  $t_r \leq 2.5$  ns,  $t_f \leq 2.5$  ns.
- D. The output is measured with one input transition per measurement.
- E.  $t_{PLZ}$  and  $t_{PHZ}$  are the same as  $t_{dis}$ .
- F.  $t_{PZL}$  and  $t_{PZH}$  are the same as  $t_{en}$ .
- G.  $t_{PLH}$  and  $t_{PHL}$  are the same as  $t_{pd}$ .

Figure 4. Load Circuit and Voltage Waveforms

DEVICE ORDERING INFORMATION

| Device        | Package                             | Shipping†          |
|---------------|-------------------------------------|--------------------|
| 7SB385DTT1G   | TSOP-5<br>(Pb-Free)                 | 3000 / Tape & Reel |
| 7SB385DFT2G   | SC-88A<br>(Pb-Free)                 | 3000 / Tape & Reel |
| 7SB385AMX1TCG | ULLGA6 – 0.5 mm Pitch<br>(Pb-Free)  | 3000 / Tape & Reel |
| 7SB385BMX1TCG | ULLGA6 – 0.4 mm Pitch<br>(Pb-Free)  | 3000 / Tape & Reel |
| 7SB385CMX1TCG | ULLGA6 – 0.35 mm Pitch<br>(Pb-Free) | 3000 / Tape & Reel |
| 7SB385MUTCG   | UDFN6 – 0.4 mm Pitch<br>(Pb-Free)   | 3000 / Tape & Reel |

†For information on tape and reel specifications, including part orientation and tape sizes, please refer to our Tape and Reel Packaging Specifications Brochure, BRD8011/D.

# 7SB385

## PACKAGE DIMENSIONS

SC-88A, SOT-353, SC-70  
CASE 419A-02  
ISSUE J

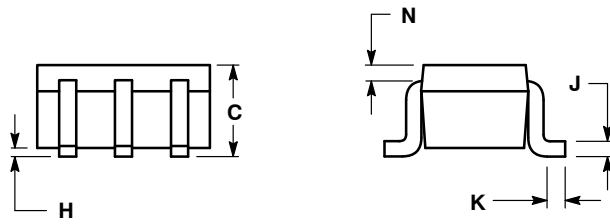
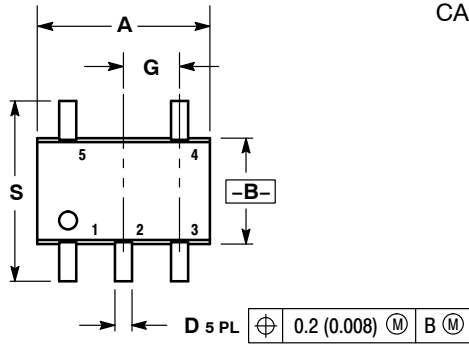

### NOTES:

1. DIMENSIONING AND TOLERANCING PER ANSI Y14.5M, 1982.
2. CONTROLLING DIMENSION: INCH.
3. 419A-01 OBSOLETE. NEW STANDARD 419A-02.
4. DIMENSIONS A AND B DO NOT INCLUDE MOLD FLASH, PROTRUSIONS, OR GATE BURRS.

| DIM | INCHES    |       | MILLIMETERS |      |
|-----|-----------|-------|-------------|------|
|     | MIN       | MAX   | MIN         | MAX  |
| A   | 0.071     | 0.087 | 1.80        | 2.20 |
| B   | 0.045     | 0.053 | 1.15        | 1.35 |
| C   | 0.031     | 0.043 | 0.80        | 1.10 |
| D   | 0.004     | 0.012 | 0.10        | 0.30 |
| G   | 0.026 BSC |       | 0.65 BSC    |      |
| H   | ---       | 0.004 | ---         | 0.10 |
| J   | 0.004     | 0.010 | 0.10        | 0.25 |
| K   | 0.004     | 0.012 | 0.10        | 0.30 |
| N   | 0.008 REF |       | 0.20 REF    |      |
| S   | 0.079     | 0.087 | 2.00        | 2.20 |

# 7SB385

## PACKAGE DIMENSIONS

### TSOP-5 CASE 483-02 ISSUE H

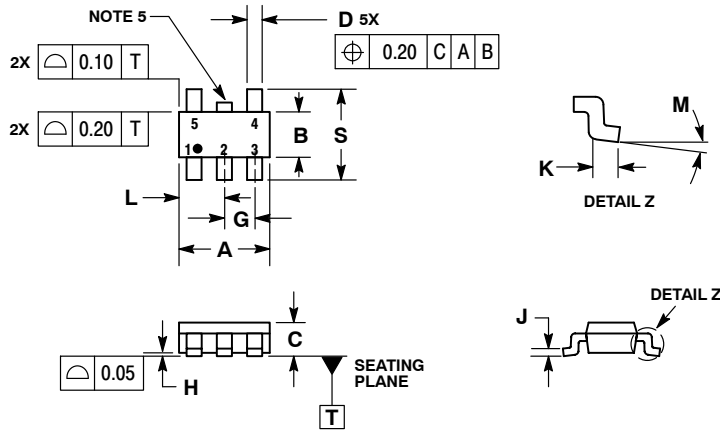

#### NOTES:

1. DIMENSIONING AND TOLERANCING PER ASME Y14.5M, 1994.
2. CONTROLLING DIMENSION: MILLIMETERS.
3. MAXIMUM LEAD THICKNESS INCLUDES LEAD FINISH THICKNESS. MINIMUM LEAD THICKNESS IS THE MINIMUM THICKNESS OF BASE MATERIAL.
4. DIMENSIONS A AND B DO NOT INCLUDE MOLD FLASH, PROTRUSIONS, OR GATE BURRS.
5. OPTIONAL CONSTRUCTION: AN ADDITIONAL TRIMMED LEAD IS ALLOWED IN THIS LOCATION. TRIMMED LEAD NOT TO EXTEND MORE THAN 0.2 FROM BODY.

| MILLIMETERS |      |      |
|-------------|------|------|
| DIM         | MIN  | MAX  |
| A           | 3.00 | BSC  |
| B           | 1.50 | BSC  |
| C           | 0.90 | 1.10 |
| D           | 0.25 | 0.50 |
| G           | 0.95 | BSC  |
| H           | 0.01 | 0.10 |
| J           | 0.10 | 0.26 |
| K           | 0.20 | 0.60 |
| L           | 1.25 | 1.55 |
| M           | 0°   | 10°  |
| S           | 2.50 | 3.00 |

### SOLDERING FOOTPRINT\*

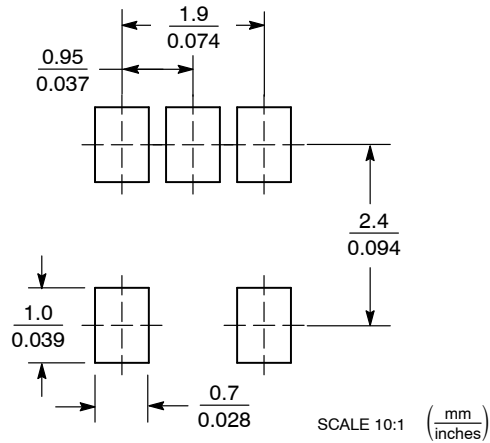

\*For additional information on our Pb-Free strategy and soldering details, please download the ON Semiconductor Soldering and Mounting Techniques Reference Manual, SOLDERRM/D.

# 7SB385

## PACKAGE DIMENSIONS

UDFN6 1.2x1.0, 0.4P  
CASE 517AA-01  
ISSUE C

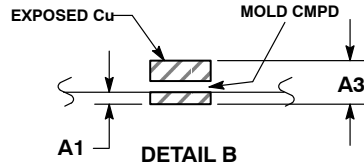
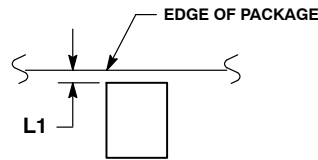
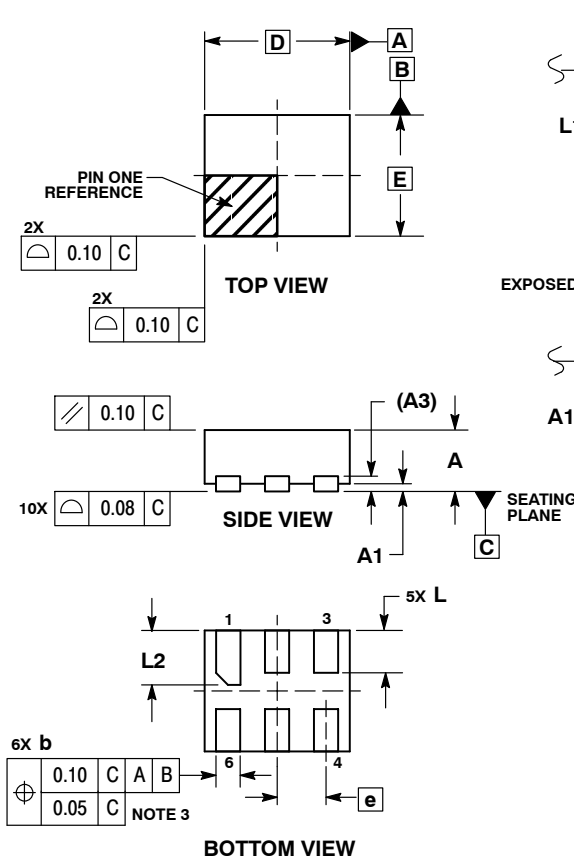

**NOTES:**

1. DIMENSIONING AND TOLERANCING PER ASME Y14.5M, 1994.
2. CONTROLLING DIMENSION: MILLIMETERS.
3. DIMENSION b APPLIES TO PLATED TERMINAL AND IS MEASURED BETWEEN 0.25 AND 0.30 mm FROM TERMINAL.
4. COPLANARITY APPLIES TO THE EXPOSED PAD AS WELL AS THE TERMINALS.

| MILLIMETERS |       |      |
|-------------|-------|------|
| DIM         | MIN   | MAX  |
| A           | 0.45  | 0.55 |
| A1          | 0.00  | 0.05 |
| A3          | 0.127 | REF  |
| b           | 0.15  | 0.25 |
| D           | 1.20  | BSC  |
| E           | 1.00  | BSC  |
| e           | 0.40  | BSC  |
| L           | 0.30  | 0.40 |
| L1          | 0.00  | 0.15 |
| L2          | 0.40  | 0.50 |

**MOUNTING FOOTPRINT\***

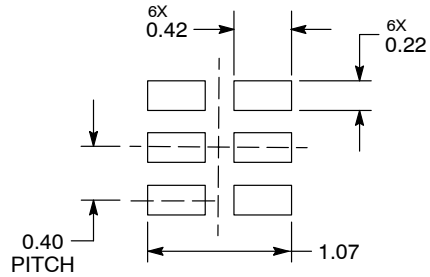

DIMENSIONS: MILLIMETERS

\*For additional information on our Pb-Free strategy and soldering details, please download the ON Semiconductor Soldering and Mounting Techniques Reference Manual, SOLDERRM/D.

# 7SB385

## PACKAGE DIMENSIONS

### ULLGA6 1.0x1.0, 0.35P CASE 613AD-01 ISSUE A

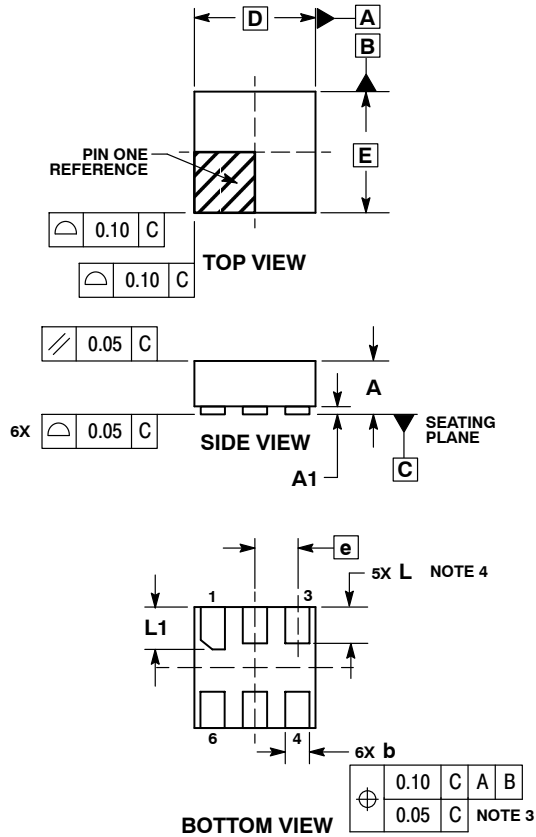

NOTES:

1. DIMENSIONING AND TOLERANCING PER ASME Y14.5M, 1994.
2. CONTROLLING DIMENSION: MILLIMETERS.
3. DIMENSION b APPLIES TO PLATED TERMINAL AND IS MEASURED BETWEEN 0.15 AND 0.30 mm FROM THE TERMINAL TIP.
4. A MAXIMUM OF 0.05 PULL BACK OF THE PLATED TERMINAL FROM THE EDGE OF THE PACKAGE IS ALLOWED.

| MILLIMETERS |          |      |
|-------------|----------|------|
| DIM         | MIN      | MAX  |
| A           | ---      | 0.40 |
| A1          | 0.00     | 0.05 |
| b           | 0.12     | 0.22 |
| D           | 1.00 BSC |      |
| E           | 1.00 BSC |      |
| e           | 0.35 BSC |      |
| L           | 0.25     | 0.35 |
| L1          | 0.30     | 0.40 |

### MOUNTING FOOTPRINT SOLDERMASK DEFINED\*

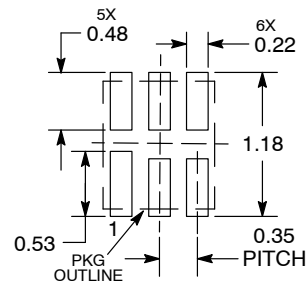

DIMENSIONS: MILLIMETERS

\*For additional information on our Pb-Free strategy and soldering details, please download the ON Semiconductor Soldering and Mounting Techniques Reference Manual, SOLDERRM/D.



# 7SB385

## PACKAGE DIMENSIONS

ULLGA6 1.2x1.0, 0.4P  
CASE 613AE-01  
ISSUE A

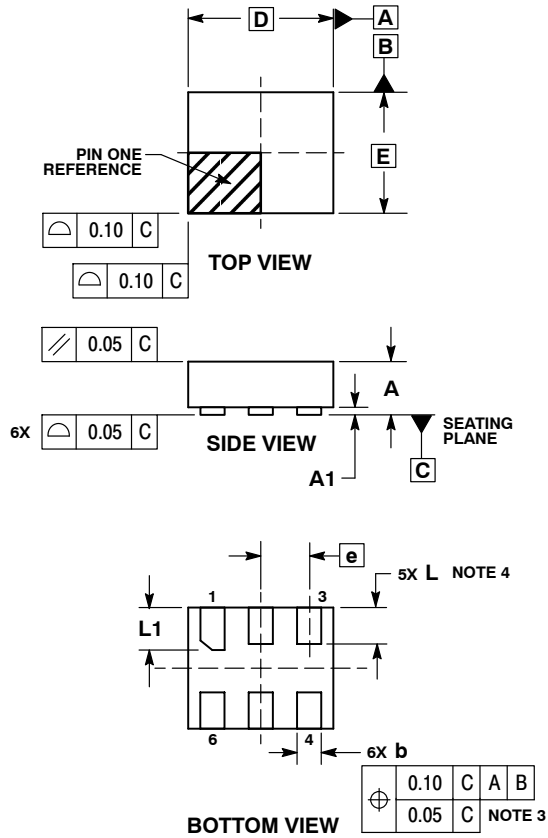

**NOTES:**

1. DIMENSIONING AND TOLERANCING PER ASME Y14.5M, 1994.
2. CONTROLLING DIMENSION: MILLIMETERS.
3. DIMENSION b APPLIES TO PLATED TERMINAL AND IS MEASURED BETWEEN 0.15 AND 0.30 mm FROM THE TERMINAL TIP.
4. A MAXIMUM OF 0.05 PULL BACK OF THE PLATED TERMINAL FROM THE EDGE OF THE PACKAGE IS ALLOWED.

| MILLIMETERS |          |      |
|-------------|----------|------|
| DIM         | MIN      | MAX  |
| A           | ---      | 0.40 |
| A1          | 0.00     | 0.05 |
| b           | 0.15     | 0.25 |
| D           | 1.20 BSC |      |
| E           | 1.00 BSC |      |
| e           | 0.40 BSC |      |
| L           | 0.25     | 0.35 |
| L1          | 0.35     | 0.45 |

**MOUNTING FOOTPRINT  
SOLDERMASK DEFINED\***

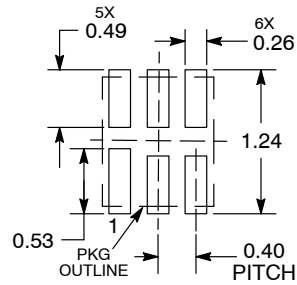

DIMENSIONS: MILLIMETERS

\*For additional information on our Pb-Free strategy and soldering details, please download the ON Semiconductor Soldering and Mounting Techniques Reference Manual, SOLDERRM/D.

# 7SB385

## PACKAGE DIMENSIONS

ULLGA6 1.45x1.0, 0.5P  
CASE 613AF-01  
ISSUE A

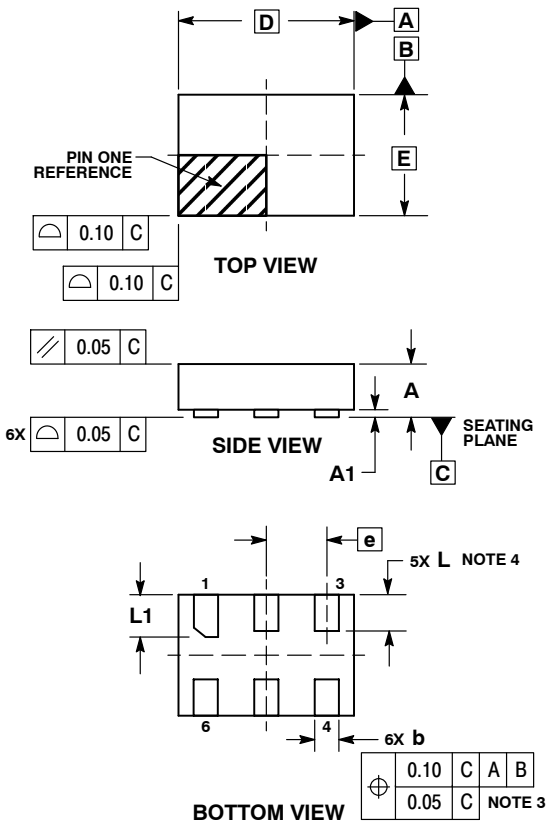

### NOTES:

1. DIMENSIONING AND TOLERANCING PER ASME Y14.5M, 1994.
2. CONTROLLING DIMENSION: MILLIMETERS.
3. DIMENSION **b** APPLIES TO PLATED TERMINAL AND IS MEASURED BETWEEN 0.15 AND 0.30 mm FROM THE TERMINAL TIP.
4. A MAXIMUM OF 0.05 PULL BACK OF THE PLATED TERMINAL FROM THE EDGE OF THE PACKAGE IS ALLOWED.

| DIM | MILLIMETERS |      |
|-----|-------------|------|
|     | MIN         | MAX  |
| A   | ---         | 0.40 |
| A1  | 0.00        | 0.05 |
| b   | 0.15        | 0.25 |
| D   | 1.45 BSC    |      |
| E   | 1.00 BSC    |      |
| e   | 0.50 BSC    |      |
| L   | 0.25        | 0.35 |
| L1  | 0.30        | 0.40 |

### MOUNTING FOOTPRINT SOLDERMASK DEFINED\*

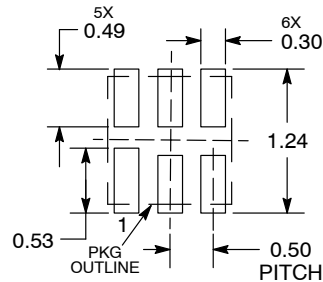

DIMENSIONS: MILLIMETERS

\*For additional information on our Pb-Free strategy and soldering details, please download the ON Semiconductor Soldering and Mounting Techniques Reference Manual, SOLDERRM/D.

ON Semiconductor and are registered trademarks of Semiconductor Components Industries, LLC (SCILLC). SCILLC reserves the right to make changes without further notice to any products herein. SCILLC makes no warranty, representation or guarantee regarding the suitability of its products for any particular purpose, nor does SCILLC assume any liability arising out of the application or use of any product or circuit, and specifically disclaims any and all liability, including without limitation special, consequential or incidental damages. "Typical" parameters which may be provided in SCILLC data sheets and/or specifications can and do vary in different applications and actual performance may vary over time. All operating parameters, including "Typicals" must be validated for each customer application by customer's technical experts. SCILLC does not convey any license under its patent rights nor the rights of others. SCILLC products are not designed, intended, or authorized for use as components in systems intended for surgical implant into the body, or other applications intended to support or sustain life, or for any other application in which the failure of the SCILLC product could create a situation where personal injury or death may occur. Should Buyer purchase or use SCILLC products for any such unintended or unauthorized application, Buyer shall indemnify and hold SCILLC and its officers, employees, subsidiaries, affiliates, and distributors harmless against all claims, costs, damages, and expenses, and reasonable attorney fees arising out of, directly or indirectly, any claim of personal injury or death associated with such unintended or unauthorized use, even if such claim alleges that SCILLC was negligent regarding the design or manufacture of the part. SCILLC is an Equal Opportunity/Affirmative Action Employer. This literature is subject to all applicable copyright laws and is not for resale in any manner.

### PUBLICATION ORDERING INFORMATION

**LITERATURE FULFILLMENT:**  
Literature Distribution Center for ON Semiconductor  
P.O. Box 5163, Denver, Colorado 80217 USA  
**Phone:** 303-675-2175 or 800-344-3860 Toll Free USA/Canada  
**Fax:** 303-675-2176 or 800-344-3867 Toll Free USA/Canada  
**Email:** orderlit@onsemi.com

**N. American Technical Support:** 800-282-9855 Toll Free  
USA/Canada  
**Europe, Middle East and Africa Technical Support:**  
Phone: 421 33 790 2910  
**Japan Customer Focus Center**  
Phone: 81-3-5773-3850

**ON Semiconductor Website:** [www.onsemi.com](http://www.onsemi.com)

**Order Literature:** <http://www.onsemi.com/orderlit>

For additional information, please contact your local Sales Representative

Компания «Life Electronics» занимается поставками электронных компонентов импортного и отечественного производства от производителей и со складов крупных дистрибьюторов Европы, Америки и Азии.

С конца 2013 года компания активно расширяет линейку поставок компонентов по направлению коаксиальный кабель, кварцевые генераторы и конденсаторы (керамические, пленочные, электролитические), за счёт заключения дистрибьюторских договоров

Мы предлагаем:

- Конкуренеспособные цены и скидки постоянным клиентам.
- Специальные условия для постоянных клиентов.
- Подбор аналогов.
- Поставку компонентов в любых объемах, удовлетворяющих вашим потребностям.
- Приемлемые сроки поставки, возможна ускоренная поставка.
- Доставку товара в любую точку России и стран СНГ.
- Комплексную поставку.
- Работу по проектам и поставку образцов.
- Формирование склада под заказчика.
- Сертификаты соответствия на поставляемую продукцию (по желанию клиента).
- Тестирование поставляемой продукции.
- Поставку компонентов, требующих военную и космическую приемку.
- Входной контроль качества.
- Наличие сертификата ISO.

В составе нашей компании организован Конструкторский отдел, призванный помогать разработчикам, и инженерам.

Конструкторский отдел помогает осуществить:

- Регистрацию проекта у производителя компонентов.
- Техническую поддержку проекта.
- Защиту от снятия компонента с производства.
- Оценку стоимости проекта по компонентам.
- Изготовление тестовой платы монтаж и пусконаладочные работы.



Тел: +7 (812) 336 43 04 (многоканальный)  
Email: [org@lifeelectronics.ru](mailto:org@lifeelectronics.ru)