

High Quality Interconnect Products For Military and Aerospace Applications

Amphenol

Amphenol Pcd



Terminal Junction Systems

MIL-T-81714 Series I Class D



MIL-T-81714 Series I Junction Modules

QPL-approved MIL-T-81714 modules and MIL-C-39029/1 contacts are available in four standard sizes accommodating 12-26 AWG wires in both feedback and feedthru types with full a selection of bussing arrangements. The complete MIL-T-81714 Series I Terminal Junction System includes the following products.



Feedback Modules
Feedthru Modules



Electronic Modules



Ground Modules



Single In-Line Splices
Dual In-Line Splices
Electronic Splices



Mounting Tracks

Key Features and Benefits

Integral Socket/Bus Bar

The patented integral socket/bus bar assembly provides superior electrical characteristics and assures mechanical integrity over a long product life. This unique design totally eliminates all solder of welded joints which could cause variation in electrical and/or mechanical performance

Integral Contacts

Integral female contacts and bus bar have no mechanical functions- only the electrical conductivity function and are highly conductive alloy for optimum electrical performance.

Split Socket Design

Split Socket Design, conforming to the mating pin diameter, provides peripheral surface wipe and contact, while utilizing the maximum mating surfaces of pin and socket.

High Density Modules

A recently introduced series of high density modules which conform to all dimensional and performance requirements of MIL-T-81714/17 is now available from Amphenol Pcd. The high density modules accept 21 size 22 contacts in a compact 3x7 configuration, with a wide variety of bus arrangements. The construction features one-piece screw machine contacts with a split socket design for maximum performance. Contacts are securely packaged within a polyetherimide housing.

Class D Modules System

Amphenol Pcd was the first supplier to qualify module and track systems to high performance MIL-T-81714 Series I Class D requirements. Class D systems combine the maximum high temperature and high fluid resistance performance parameters previously divided among three module classes A,B, and C.

Electronic Splices

TJSE electronic modules can be supplied with a wide variety of diodes, resistors, capacitors, and fuses within the splice itself. TJSE electronic splices meet the electrical parameters of MIL-81714/24 and allow customers to incorporate system modifications into a wire bundle, avoiding changes in panles modules.



Military Qualified, QPL-Listed

MIL-T-81714 Series I, Class D

Class D Feedback Modules

Military P/N	Amphenol Pcd P/N	Page
M81714/1-DA1	TJM122701	36
M81714/1-DB1	TJM122702	36
M81714/1-DB2	TJM122703	36
M81714/1-DB3	TJM122704	36
M81714/1-DC1	TJM122705	36
M81714/1-DC2	TJM122706	36
M81714/1-DC3	TJM122710	36
M81714/1-DC4	TJM122712	36
M81714/1-DD1	TJM122707	36
M81714/1-DD2	TJM122711	36
M81714/1-DE1	TJM122708	36
M81714/2-DA1	TJM120701	37
M81714/2-DB1	TJM120702	37
M81714/2-DB2	TJM120703	37
M81714/2-DB3	TJM120704	37
M81714/2-DC1	TJM120705	37
M81714/2-DC2	TJM120706	37
M81714/2-DC3	TJM120710	37
M81714/2-DC4	TJM120712	37
M81714/2-DD1	TJM120707	37
M81714/2-DD2	TJM120711	37
M81714/2-DE1	TJM120708	37
M81714/3-DA1	TJM116701	38
M81714/3-DB1	TJM116702	38
M81714/3-DB2	TJM116703	38
M81714/3-DC1	TJM116705	38
M81714/3-DC2	TJM116706	38
M81714/3-DD1	TJM116707	38
M81714/4-DA1	TJM112701	39
M81714/4-DB1	TJM112702	39
M81714/4-DB2	TJM112703	39
M81714/4-DC1	TJM112705	39
M81714/4-DC2	TJM112706	39
M81714/4-DD1	TJM112707	39
M81714/17-D30	TJHD22700	40
M81714/17-D31	TJHD22701	40
M81714/17-D32	TJHD22702	40
M81714/17-D33	TJHD22703	40
M81714/17-D34	TJHD22704	40
M81714/17-D35	TJHD22705	40
M81714/17-D36	TJHD22706	40
M81714/17-D37	TJHD22707	40
M81714/17-D38	TJHD22708	40
M81714/17-D39	TJHD22709	40
M81714/17-D40	TJHD22710	40
M81714/17-D42	TJHD22712	40
M81714/17-D43	TJHD22713	40
M81714/17-D44	TJHD22714	40
M81714/17-D45	TJHD22715	40

Class D Feedthru Modules

Military P/N	Amphenol Pcd P/N	Page
M81714/6-DA1	TJM222701	36
M81714/6-DB1	TJM222702	36
M81714/6-DB2	TJM222703	36
M81714/6-DB3	TJM222704	36
M81714/6-DC1	TJM222705	36
M81714/6-DC2	TJM222706	36
M81714/6-DD1	TJM222707	36
M81714/6-DE1	TJM222708	36
M81714/6-DJ1	TJM222709	36
M81714/7-DA1	TJM220701	37
M81714/7-DB1	TJM220702	37
M81714/7-DB2	TJM220703	37
M81714/7-DB3	TJM220704	37
M81714/7-DC1	TJM220705	37
M81714/7-DC2	TJM220706	37
M81714/7-DD1	TJM220707	37
M81714/7-DE1	TJM220708	37
M81714/7-DJ1	TJM220709	37
M81714/8-DA1	TJM216701	38
M81714/8-DB1	TJM216702	38
M81714/8-DB2	TJM216703	38
M81714/8-DC1	TJM216705	38
M81714/8-DC2	TJM216706	38
M81714/8-DD1	TJM216707	38
M81714/8-DG1	TJM216708	38
M81714/8-DH1	TJM216709	38
M81714/9-DA1	TJM212701	39
M81714/9-DB2	TJM212702	39
M81714/9-DB3	TJM212703	39
M81714/9-DC1	TJM212705	39
M81714/9-DC2	TJM212706	39
M81714/9-DD1	TJM212707	39
M81714/9-DH1	TJM212709	39

Terminal Junction Modules

M81714/1, /6 Series I Size 22 Class D

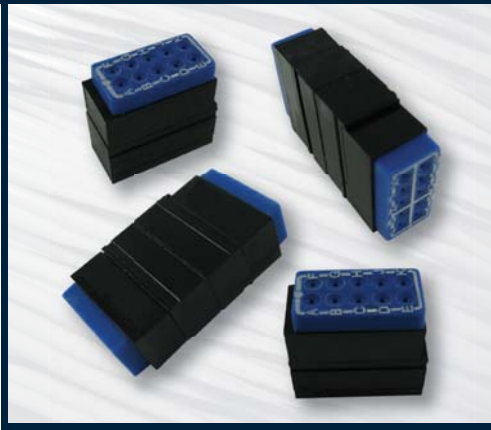

Operating Range

Temperature:
-65°C to 200°C
Insulation Resistance:
5000 Megaohms @ 25°C
Dielectric Withstanding Voltage:
1500 VRMS at Sea Level
200 VRMS at 100,000 ft.
Current Rating
5 Amps
Vibration & Shock:
MIL-T-81714 Paragraph
3.5.5 and 3.5.8

Materials

Module Body:
Polyetherimide per ASTM-D5205
Grommet:
Silicone Blend Elastomer per A-A-59588
Contact Retainers:
Stainless Steel
Internal Socket Contacts:
Copper Alloy, Hard Gold Plated in
Accordance with MIL-G-45204
Accepts Multiple Wire Sizes:
Size 22, 24, 26 AWG

Amphenol Pcd Terminal Junction Modules

Bussing Configurations	Feedback		Feedthru		Contact		
	Military P/N	APCD P/N	Military P/N	APCD P/N	QTY*	Size ¹	P/N M39029
	M81714/1-DA1	TJM122701	M81714/6-DA1	TJM222701	10	16/22	/1-100
	M81714/1-DB1	TJM122702	M81714/6-DB1	TJM222702	10	16/22	/1-100
	M81714/1-DB2	TJM122703	M81714/6-DB2	TJM222703	10	16/22	/1-100
	M81714/1-DB3	TJM122704	M81714/6-DB3	TJM222704	10	16/22	/1-100
	M81714/1-DC1	TJM122705	M81714/6-DC1	TJM222705	10	16/22	/1-100
	M81714/1-DC2	TJM122706	M81714/6-DC2	TJM222706	10	16/22	/1-100
	M81714/1-DC3	TJM122710			10	16/22	/1-100
	M81714/1-DC4	TJM122712			10	16/22	/1-100
	M81714/1-DD1	TJM122707	M81714/6-DD1	TJM222707	10	16/22	/1-100
	M81714/1-DD2	TJM122711			10	16/22	/1-100
	M81714/1-DE1	TJM122708	M81714/6-DE1	TJM222708	10	16/22	/1-100
			M81714/6-DJ1	TJM222709	10	16/22	/1-100

* Contact quantity for feedthru is double feedback. Quantity figure denotes number of contacts accommodated by module. Modules are supplied with one additional spare contact and sealing plug.
¹ Mating Pin / Wire Barrel

Terminal Junction Module Dimensions

Feedback Dimensions

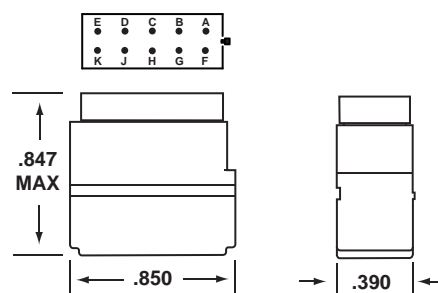

Feedthru Dimensions

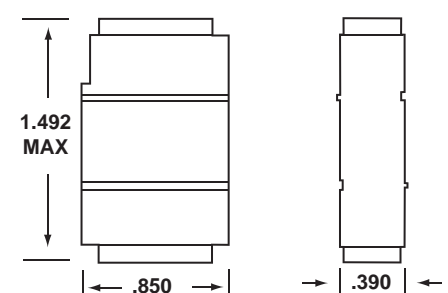

M81714/2, /7

Series I Size 20 Class D

Operating Range

Temperature:

-65°C to 200°C

Insulation Resistance:

5000 Megaohms @ 25°C

Dielectric Withstanding Voltage:

1500 VRMS at Sea Level

200 VRMS at 100,000 ft.

Current Rating

7.5 Amps

Vibration & Shock:

MIL-T-81714 Paragraph

3.5.5 and 3.5.8

Materials

Module Body:

Polyetherimide per ASTM-D5205

Grommet:

Silicone Blend Elastomer per A-A-59588

Contact Retainers:

Stainless steel

Socket Contacts:

Copper Alloy, Hard Gold Plated in

Accordance with MIL-G-45204

Accepts Multiple Wire Sizes:

Size 20, 22, 24 AWG

Terminal Junction Modules

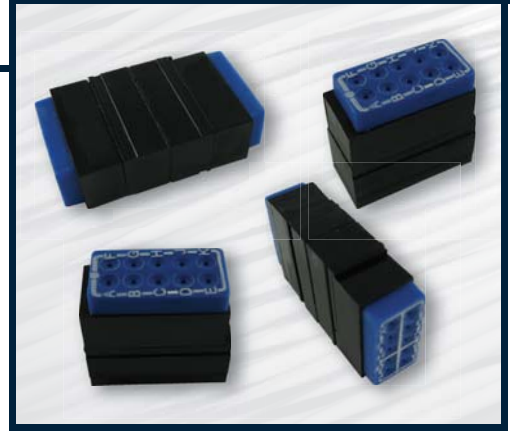

Amphenol Pcd Terminal Junction Modules

Bussing Configurations	Feedback		Feedthru		Contact		
	Military P/N	APCD P/N	Military P/N	APCD P/N	QTY*	Size ¹	P/N M39029
	M81714/2-DA1	TJM120701	M81714/7-DA1	TJM220701	10	16/20	/1-101
	M81714/2-DB1	TJM120702	M81714/7-DB1	TJM220702	10	16/20	/1-101
	M81714/2-DB2	TJM120703	M81714/7-DB2	TJM220703	10	16/20	/1-101
	M81714/2-DB3	TJM120704	M81714/7-DB3	TJM220704	10	16/20	/1-101
	M81714/2-DC1	TJM120705	M81714/7-DC1	TJM220705	10	16/20	/1-101
	M81714/2-DC2	TJM120706	M81714/7-DC2	TJM220706	10	16/20	/1-101
	M81714/2-DC3	TJM120710			10	16/20	/1-101
	M81714/2-DC4	TJM120712			10	16/20	/1-101
	M81714/2-DD1	TJM120707	M81714/7-DD1	TJM220707	10	16/20	/1-101
	M81714/2-DD2	TJM120711			10	16/20	/1-101
	M81714/2-DE1	TJM120708	M81714/7-DE1	TJM220708	10	16/20	/1-101
			M81714/7-DJ1	TJM220709	10	16/20	/1-101

* Contact quantity for feedthru is double feedback. Quantity figure denotes number of contacts accommodated by module. Modules are supplied with one additional spare contact and sealing plug.
¹ Mating Pin / Wire Barrel

Terminal Junction Module Dimensions

Feedback Dimensions

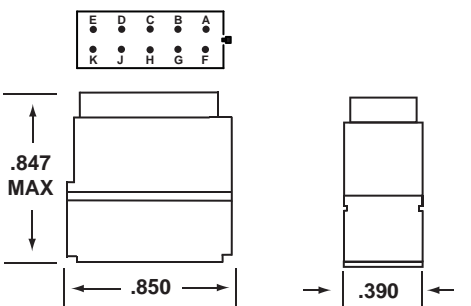

Feedthru Dimensions

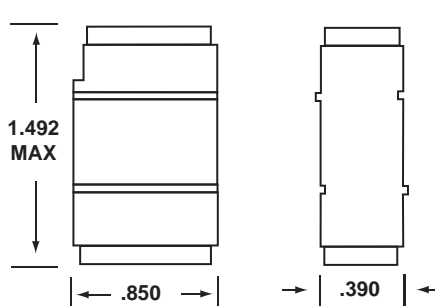

Amphenol Pcd

Terminal Junction Modules

M81714/3, /8 Series I Size 16 Class D



Operating Range

Temperature:
-65°C to 200°C

Insulation Resistance:
5000 Megaohms @ 25°C

Dielectric Withstanding Voltage:
1500 VRMS at Sea Level
200 VRMS at 100,000 ft.

Current Rating
13 Amps

Vibration & Shock:
MIL-T-81714 Paragraph
3.5.5 and 3.5.8

Materials

Module Body:
Polyetherimide per ASTM-D5205

Grommet:
Silicone Blend Elastomer per A-A-59588

Contact Retainers:
Stainless Steel

Socket Contacts:
Copper Alloy, Hard Gold Plated in
Accordance with MIL-G-45204

Accepts Multiple Wire Sizes:
Size 16, 18, 20 AWG

Amphenol Pcd Terminal Junction Modules

Bussing Configurations	Feedback		Feedthru		Contact		
	Military P/N	APCD P/N	Military P/N	APCD P/N	QTY*	Size ¹	P/N M39029
	M81714/3-DA1	TJM116701	M81714/8-DA1	TJM216701	8	14/16	/1-102
	M81714/3-DB1	TJM116702	M81714/8-DB1	TJM216702	8	14/16	/1-102
	M81714/3-DB2	TJM116703	M81714/8-DB2	TJM216703	8	14/16	/1-102
	M81714/3-DC1	TJM116705	M81714/8-DC1	TJM216705	8	14/16	/1-102
	M81714/3-DC2	TJM116706	M81714/8-DC2	TJM216706	8	14/16	/1-102
	M81714/3-DD1	TJM116707	M81714/8-DD1	TJM216707	8	14/16	/1-102
			M81714/8-DG1	TJM216708	8	14/16	/1-102
			M81714/8-DH1	TJM216709	8	14/16	/1-102

* Contact quantity for feedthru is double feedback. Quantity figure denotes number of contacts accommodated by module. Modules are supplied with one additional spare contact and sealing plug.
¹ Mating Pin / Wire Barrel

Terminal Junction Module Dimensions



Feedback Dimensions

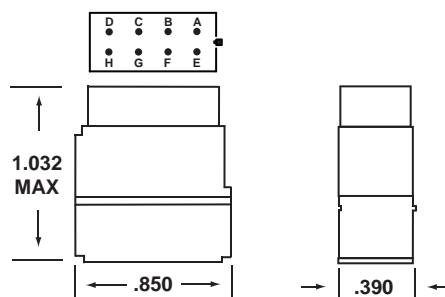

Feedthru Dimensions

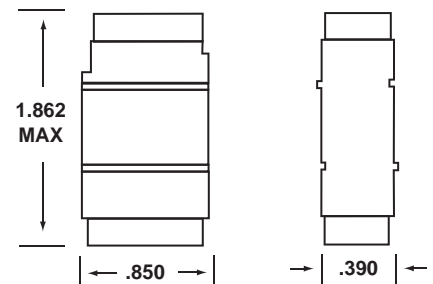

M81714/4, /9

Series I Size 12 Class D

Terminal Junction Modules

Operating Range

Temperature:

-65°C to 200°C

Insulation Resistance:

5000 Megaohms @ 25°C

Dielectric Withstanding Voltage:

1500 VRMS at Sea Level

200 VRMS at 100,000 ft.

Current Rating

23 Amps

Vibration & Shock:

MIL-T-81714 Paragraph

3.5.5 and 3.5.8

Materials

Module Body:

Polyetherimide per ASTM-D5205

Grommet:

Silicone Blend Elastomer per A-A-59588

Contact Retainers:

Stainless steel

Internal Socket Contacts:

Copper Alloy, Hard Gold Plated in

Accordance with MIL-G-45204

Accepts Multiple Wire Sizes:

Size 12, 14 AWG



Terminal Junction Modules

Bussing Configurations	Feedback		Feedthru		Contact		
	Military P/N	APCD P/N	Military P/N	APCD P/N	QTY*	Size ¹	P/N M39029
	M81714/4-DA1	TJM112701	M81714/9-DA1	TJM212701	8	12/12	/1-103
	M81714/4-DB1	TJM112702	M81714/9-DB1	TJM212702	8	12/12	/1-103
	M81714/4-DB2	TJM112703	M81714/9-DB2	TJM212703	8	12/12	/1-103
	M81714/4-DC1	TJM112705	M/81714/9-DC1	TJM212705	8	12/12	/1-103
	M81714/4-DC2	TJM112706	M81714/9-DC2	TJM212706	8	12/12	/1-103
	M81714/4-DD1	TJM112707	M81714/9-DD1	TJM212707	8	12/12	/1-103
			M81714/9-DH1	TJM212709	8	12/12	/1-103

* Contact quantity for feedthru is double feedback. Quantity figure denotes number of contacts accommodated by module. Modules are supplied with one additional spare contact and sealing plug.

¹ Mating Pin / Wire Barrel

Terminal Junction Module Dimensions

Feedback Dimensions

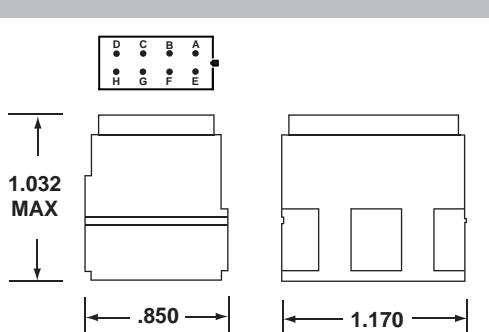

Feedthru Dimensions

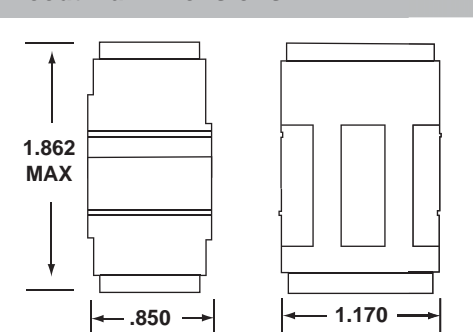

Amphenol Pcd

M81714/17 High Density Modules

Series I Size 22D Class D

Terminal Junction Modules



Operating Range

Temperature:
-65°C to 200°C

Insulation Resistance:
5000 Megaohms @ 25°C

Dielectric Withstanding Voltage:
1000 VRMS at Sea Level
200 VRMS at 110,000 ft.

Current Rating
5 Amps

Vibration & Shock:
MIL-T-81714 Paragraph
3.5.5 and 3.5.8

Materials

Module Body:
Polyetherimide per ASTM-D5205

Grommet:
Silicone Blend Elastomer per A-A-59588

Contact Retainers:
Stainless Steel

Internal Socket Contacts:
Copper Alloy, Hard Gold Plated in
Accordance with MIL-G-45204

Accepts Multiple Wire Sizes:
Size 22, 26 AWG

Amphenol Pcd Terminal Junction Modules

Bussing Configurations	Feedback	
	Military P/N	APCD P/N
	M81714/17-D30	TJHD22700
	M81714/17-D31	TJHD22701
	M81714/17-D32	TJHD22702
	M81714/17-D33	TJHD22703
	M81714/17-D34	TJHD22704
	M81714/17-D35	TJHD22705
	M81714/17-D36	TJHD22706
	M81714/17-D37	TJHD22707

Bussing Configurations	Feedback	
	Military P/N	APCD P/N
	M81714/17-D38	TJHD22708
	M81714/17-D39	TJHD22709
	M81714/17-D40	TJHD22710
	M81714/17-D42	TJHD22712
	M81714/17-D43	TJHD22713
	M81714/17-D44	TJHD22714
	M81714/17-D45	TJHD22715

Contacts Supplied: M39029/1-507 Qty 22

Terminal Junction Module Dimensions



Feedback Dimensions

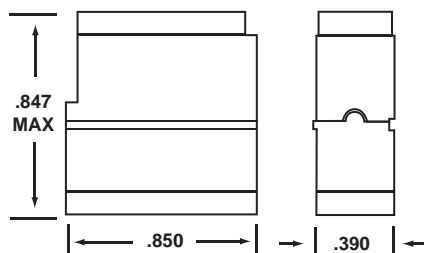

Bussing Configuration

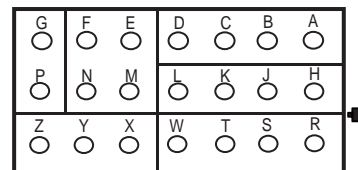

Contacts Supplied: M39029/1-507
Quantity Supplied: 22

M81714/27 Ground Stud Modules

Series II Size 22, 20, 16, 12, Class D

Operating Range

Temperature:

-65°C to 200°C

Current Rating

5 Amps (Size 22)

7.5 Amps (Size 20)

13 Amps (Size 16)

23 Amps (Size 12)

Vibration & Shock:

MIL-T-81714 Paragraph

3.5.5 and 3.5.8

Materials

Module Body:

Polyetherimide per ASTM-D5205

Grommet:

Silicone Blend Elastomer per A-A-59588

Mounting Stud:

Copper Alloy, Gold Plated per

SAE-AMS-2422.

Contact Retainers:

Stainless Steel

Internal Socket Contacts:

Copper Alloy, Hard Gold Plated in

Accordance with MIL-G-45204

Terminal Junction Modules



Terminal Grounding Modules Part Numbers

Part Numbers		Contact		
Military Equivalent P/N	APCD P/N	QTY*	Size ¹	P/N M39029
M81714/27-22	TJG122701	10	16/22	/1-100
M81714/27-20	TJG120701	10	16/20	/1-101
M81714/27-16	TJG116701	8	14/16	/1-102
M81714/27-12	TJG112701	8	12/12	/1-103

* Mating End/ Wire Barrel

¹ Quantity figure denotes number of contacts accommodated by module. Modules are supplied with two additional spare contacts and sealing plugs

Product Description

Multi-contact grounding/bus connection modules are provided with an integral threaded grounding stud. The stud is electrically and mechanically common to all internal contacts of the module.

Electrical connection and mechanical mounting are achieved through a single #10-32 stud. The modules are dimensional identical to the equivalent MIL-T-81714/27 grounding stud modules.

Direct mounting to a ground plane or ground wire with the terminal lug creates a convenient multi-wire sealed grounding device.

Direct attachment to a bus bar transforms the device into a bus connection module for multi-contact power distribution, sensing or metering.

All modules are furnished with complete mounting hardware.

Terminal Junction Module Dimensions

Top View



Side View

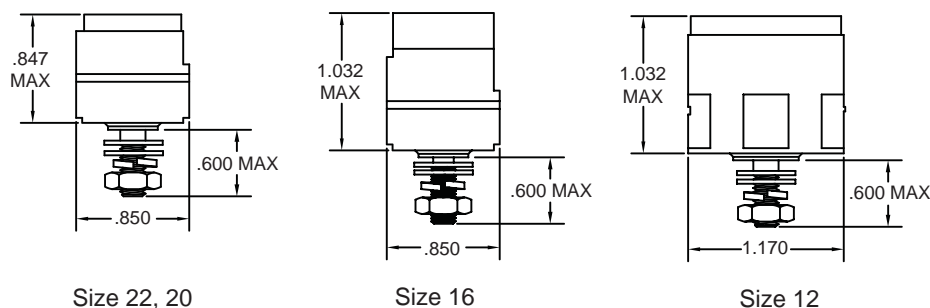

Amphenol Pcd

Electronic Terminal Junction Modules

MIL-T-81714/26 Compatible Class D

Terminal Junction Modules



Operating Range

Temperature:

-65°C to 200°C*

Insulation Resistance:

5000 Megaohms Min. @ 25°C*

Dielectric Withstanding Voltage:

1500 VRMS at Sea Level

200 VRMS at 100,000 ft.*

Vibration & Shock:

Per MIL-T-81714

Paragraph 3.5.5 & 3.5.9*

Current Rating:

7.5 amps*

Materials

Module Body:

Polyetherimide per ASTM-D-5205

Grommet:

Silicone Rubber per A-A-59588

Contact Retainers:

Stainless Steel

Internal Contact:

Copper Alloy, Gold Finish

* May vary due to internal electronic component

Amphenol Pcd Terminal Junction Module

Product Description

Electronic Terminal Junction modules meet all dimensional and performance requirements of M81714/26 and are specifically developed for electronic component packaging. Available for size 20 and 22 contacts, these modules function as highly efficient and reliable Electronic component packages. They improve system efficiency and density by permitting various electronic components such as diodes, resistors, fuses, and capacitors, which usually take up valuable space elsewhere in the system, to be securely packaged within the module housing.

Amphenol Pcd electronic modules offer significant design, material and construction improvements over competitive modules. Hand soldering operations have been completely eliminated. Electronic components are encapsulated in a semi-rigid elastomer that provides electrical spacing and insulation as well as shock and vibration protection.

Typical commercially available diode configurations are indicated on this page. A broad variety of additional configurations are available, and modules can be customized to meet specific customer designs. Please contact Amphenol Pcd to review requirements and discuss available options.

Circuit Diagram	APCD P/N	Diode P/N	Quantity
	TJE120810	JANTX1N5552	5
	TJE120811	JANTX1N5552	4
	TJE120815	1N4005	2
	TJE120998	BYW56	2
	TJE120999	BYW56	2

Terminal Junction Module Dimensions

Top View

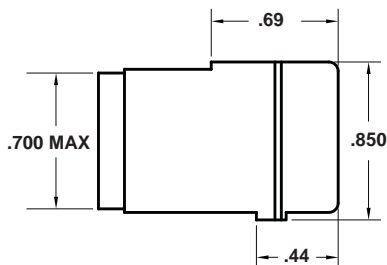

Side View

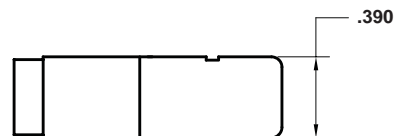

Electronic Terminal Junction Modules

MIL-T-81714/26 Compatible Class D

Terminal Junction Modules

Amphenol Pcd's Electronic Terminal Junction Modules are available with a variety of components and in a wide range of configurations. Components available include but are not limited to diodes, resistors, fuses, capacitors, thyristors, and inductors, and are also available with multiple components within one module. The following are currently available Electronic Terminal Junction Modules, although there are new configurations produced regularly and customized components are also available.



Amphenol Pcd Electronic Terminal Junction Modules

Circuit Diagram	APCD P/N	Part	Part P/N	Quantity
	TJE120514	Capacitor	620pF	1
	TJE120816	Diode	IN4003	3
	TJE120817	Diode	IN4003	2
	TJE120818	Diode	IN4003	3
	TJE120819	Diode	IN4003	3
	TJE120820	Diode	IN4003	3
	TJE120822	Diode	IN4007	5
	TJE120824	Diode	JANTX1N5618	5
	TJE120826	Diode	IN4006	2
	TJE120827	Diode	JANTX1N5552	2
	TJE120828	Diode	JANTX1N5618	2
	TJE120829	Diode	1N5618	2
	TJE120831	Diode	1N5618	2
	TJE120833	Diode	1N5418	2

Circuit Diagram	APCD P/N	Part	Part P/N	Quantity
	TJE120900	Resistor	10 K Ω , 1/8 W	5
	TJE120902	Resistor	150K Ω , 1/8 W	5
	TJE120903	Resistor	33 Ω , 1/4 W	2
	TJE120904	Resistor	1K Ω , 1/8 W	2
	TJE120905	Resistor	1K Ω , 1/2 W	2
	TJE120906	Resistor	150 Ω , 1/2 W	1
	TJE120907	Resistor	180 Ω , 1/2 W	1
	TJE120908	Resistor	Various Ω , 1/2 W	5
	TJE120920	Resistor	54K, 6K Ω , 1/2W	2
	TJE120921	Resistor	500K Ω , 1 W	5
	TJE120922	Resistor	Various Ω , 1/2 W	5
	TJE120924	Resistor	1K Ω , 1/4 W	4
	TJE120927	Fuse	1 AMP	5
	TJE120928	Resistor	1.3K Ω , 1/2 W	5

Terminal Junction Splices

Single/ Dual/ Diode M81714/11, /12,/24 Series I

Terminal Junction Splices



Operating Range

Temperature:
-65°C to 200°C
Insulation Resistance:
5000 Megaohms Min.
Dielectric Withstanding Voltage:
1500 VRMS at Sea Level
200 VRMS at 100,000 ft.
Vibration & Shock:
Per AS-81714
Paragraph 3.5.5 & 3.5.8

Materials

Insulator Body:
Polyetherimide per ASTM-D-5205
Grommet:
Silicone Rubber per A-A-59588
Internal Contact:
Copper Alloy, Gold Finish
Accordance with MIL-G-45204

Product Description

Single and Dual Splices and Electronic Splices are designed to provide a quick and efficient solution to customer wiring requirements.

Single and Dual Wire Splices meet MIL-T-81714/11 & 12 requirements and are highly resistant to temperature and fluids.

TJSE electronic modules can be supplied with a wide variety of diodes, resistors, capacitors, and fuses within the splice itself. TJSE electronic splices meet the electronic parameters of MIL-81714/24 and allow customers to incorporate system modifications into a wire bundle, avoiding changes in panels or boards.

Typical examples are represented to the right, but customer specific designs are welcomed, and an extensive list of existing splices are available on the next page.

Single Wire Splices

	Contacts		Part Numbers		
	Military P/N	APCD P/N	Quantity	Size*	Part No.
	M81714/11-22D	TJS322700	2	16/22	M39029/1-100
	M81714/11-20D	TJS320700	2	16/20	M39029/1-101
	M81714/11-12D	TJS316700	2	14/16	M39029/1-102
	M81714/11-16D	TJS312700	2	12/12	M39029/1-103

Dual Wire Splices

Bussing Type	Part Numbers		Contacts		Diameter	
	MIL P/N 81714	APCD P/N	Quantity	Size* P/N M39029	A	B
	/12-22D-1	TJS322701	4	16/22 /1-100	.400	.275
	/12-20D-1	TJS320701	4	16/20 /1-101	.400	.275
	/12-16D-1	TJS316701	4	14/16 /1-102	.500	.300
	/12-22D-2	TJS322702	4	16/22 /1-100	.400	.275
	/12-20D-2	TJS320702	4	16/20 /1-101	.400	.275
	/12-16D-2	TJS316702	4	14/16 /1-102	.500	.300

Electronic Splices

Circuit Type	Part Numbers		Diode		Contacts	
	APCD P/N	Diode P/N	Quantity	Size*	Quantity	P/N M39029
	TJSE22707	JANTX1N5622	1	16/22	4	1-100
	TJSE20705	JANTX1N5622	1	16/20	4	1-101
	TJSE22709	JANTX1N5622	2	16/22	4	1-100
	TJSE20705	JANTX1N5622	2	16/20	4	1-101

*Mating Pin Wire Barrel

Relay Socket Dimensions

Single Splice

1.552 Max
.250 ± .025 Diameter

Double Splice

Dimension C
Size 20/22 1.552 Max
Size 16 1.922 Max

Electronic Splice

2.000 Max
.275 Max

Electronic Terminal Junction Splices

MIL-T-81714/24 Compatible Class D

Terminal Junction Modules

Amphenol Pcd's Electronic Terminal Junction Splices are available with a variety of components and in a wide range of configurations. Components available include but are not limited to diodes, resistors, fuses, capacitors, thyristors, and inductors, and are also available with multiple components within one module. The following are currently available Electronic Terminal Junction Splices, although there are new configurations produced regularly and customized components are also available.



Amphenol Pcd Terminal Junction Splices

Circuit Diagram **APCD P/N** **Part** **Part P/N** **Quantity**

	TJSE20501	Inductor	1 100μH	1
--	-----------	----------	---------	---

	TJSE20503	Fuse	5 AMP 125V	1
--	-----------	------	------------	---

	TJSE20505	Resistor	RW81 38Ω 1W	1
--	-----------	----------	-------------	---

	TJSE20506	Resistor	120 Ω 1/4W	2
--	-----------	----------	------------	---

	TJSE20509	Diode	5 Amp	2
--	-----------	-------	-------	---

	TJSE20510	Diode	1 Amp 125V	1
--	-----------	-------	------------	---

	TJSE20513	Capacitor	620pF	1
--	-----------	-----------	-------	---

	TJSE20520	Capacitor	390pF	5
--	-----------	-----------	-------	---

	TJSE20523	Resistor	15KΩ 1/4W	1
--	-----------	----------	-----------	---

	TJSE20525	Resistor	10K Ω 1/4W	1
--	-----------	----------	------------	---

	TJSE20526	Resistor	910 Ω 1/4W	1
--	-----------	----------	------------	---

	TJSE20553	Resistor	1KΩ 1/2W	1
--	-----------	----------	----------	---

	TJSE20554	Resistor	18KΩ 1/2W	2
--	-----------	----------	-----------	---

	TJSE20555	Resistor	18KΩ 1/2W	1
--	-----------	----------	-----------	---

Circuit Diagram **APCD P/N** **Part** **Part P/N** **Quantity**

	TJSE20599	Diode	JANTX1N5554	1
--	-----------	-------	-------------	---

	TJSE20602	Diode	JANTX1N5618	2
--	-----------	-------	-------------	---

	TJSE20703	Diode	1N5819	2
--	-----------	-------	--------	---

	TJSE20705	Diode	JANTX1N5622	1
--	-----------	-------	-------------	---

	TJSE20706	Diode	JANTX1N5622	2
--	-----------	-------	-------------	---

	TJSE20710	Diode	1N5622	1
--	-----------	-------	--------	---

	TJSE20711	Diode	1N4006	2
--	-----------	-------	--------	---

	TJSE22503	Fuse	5 AMP 125V	1
--	-----------	------	------------	---

	TJSE22514	Resistor	10K Ω, 1/4 W	1
--	-----------	----------	--------------	---

	TJSE22517	Resistor	120 Ω, 1 W	1
--	-----------	----------	------------	---

	TJSE22523	Resistor	75K Ω, 1/2 W	2
--	-----------	----------	--------------	---

	TJSE22707	Diode	JANTX1N5622	2
--	-----------	-------	-------------	---

	TJSE20599	Diode	1N5622	1
--	-----------	-------	--------	---

	TJSE20599	Resistor	78.7 Ω, 1/4 W	2
--	-----------	----------	---------------	---



Operating Range

Temperature:
-65° to 200°C

Corrosion:

No Exposure of Base Metal
After 48 Hours of Salt Spray

Magnetic Permeability:
2.0 MU Max.

Vibration and Shock:

Per MIL-T-81714 Paragraph
3.5.5 and 3.5.8

Materials

Rail:

Aluminum Alloy, Black Anodized
Finish per MIL-A-8625

Locking Clamp Screw:

Corrosion Resistant, Passivated,
Self Locking

Product Description

Amphenol Pcd offers feedback and feedthru mounting tracks, as well as a light weight feedback type with weight reduction cutouts per MIL-T-81714/16 for weight critical applications.

One track holds all module sizes. With size 22,20,16 modules requiring one mounting space and size 12 requiring three.

Each track unit consists of an aluminum alloy track and MIL-T-81714/16 anodized black locking clamp. The stainless steel clamp screw is self locking to meet vibration, shock and temperature variation requirements.

Feedback Track Dimensions

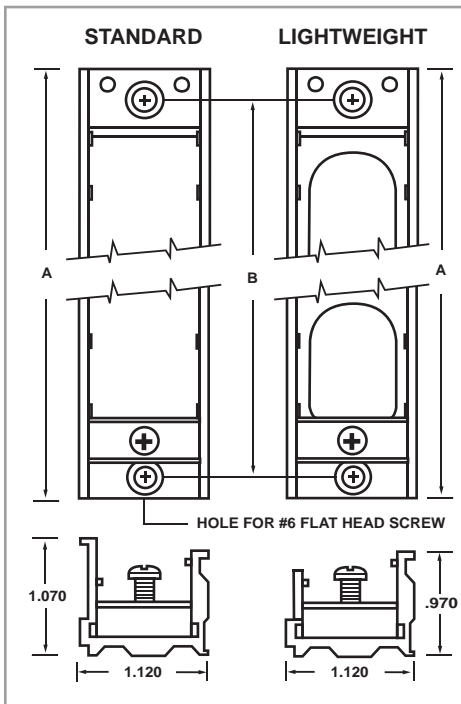

Feedback Mounting Tracks

Standard		Lightweight		Dimensions		
Military P/N	APCD P/N	Military P/N	APCD P/N	Mounting Pos.*	A	B
M81714/5-1	TJT701010	M81714/16-1	TJT703010	10	5.29	4.79
	TJT701002		TJT703002	2	2.17	1.67
M81714/5-2	TJT701003	M81714/16-2	TJT703003	3	2.56	2.06
M81714/5-3	TJT701004	M81714/16-3	TJT703004	4	2.95	2.45
M81714/5-4	TJT701005	M81714/16-4	TJT703005	5	3.34	2.84
M81714/5-5	TJT701006	M81714/16-5	TJT703006	6	3.73	3.23
M81714/5-6	TJT701007	M81714/16-6	TJT703007	7	4.12	3.62
M81714/5-7	TJT701008	M81714/16-7	TJT703008	8	4.51	4.01
M81714/5-8	TJT701009	M81714/16-8	TJT703009	9	4.90	4.40
M81714/5-9	TJT701011	M81714/16-9	TJT703011	11	5.68	5.18
M81714/5-10	TJT701012	M81714/16-10	TJT703012	12	6.07	5.57
M81714/5-11	TJT701013	M81714/16-11	TJT703013	13	6.46	5.96
M81714/5-12	TJT701014	M81714/16-12	TJT703014	14	6.85	6.35
M81714/5-13	TJT701015	M81714/16-13	TJT703015	15	7.24	6.74
	TJT701016		TJT703016	16	7.63	7.13
	TJT701017		TJT703017	17	8.02	7.52
	TJT701018		TJT703018	18	8.41	7.91
	TJT701019		TJT703019	19	8.80	8.30
	TJT701020		TJT703020	20	9.19	8.69

*Divide by 3 for Size 12 Module Mounting

Feedthru Track Dimensions

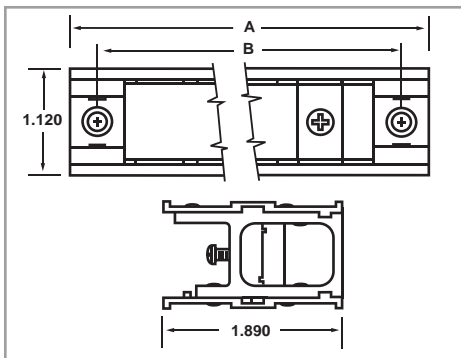

Feedthru Mounting Tracks

Standard		Dimensions		
Military P/N	APCD P/N	Mounting Pos.*	A"	B"
M81714/10-1	TJT702010	10	5.55	5.05
	TJT702002	2	2.43	1.91
M81714/10-2	TJT702003	3	2.82	2.32
M81714/10-3	TJT702004	4	3.21	2.71
M81714/10-4	TJT702005	5	3.60	3.10
M81714/10-5	TJT702006	6	3.90	3.49
M81714/10-6	TJT702007	7	4.38	3.88
M81714/10-7	TJT702008	8	4.77	4.27
M81714/10-8	TJT702009	9	5.16	4.66

*Divide by 3 for Size 12 Module Mounting

Socket Junction Systems

MIL-T-81714 Series I Class D



MIL-T-81714 Series II Junction Modules

The high pin count, low weight MIL-T-81714 Series II Socket Junction Module System is available in four basic module sizes, accommodating 12-26 AWG wire in a broad selection of bussing arrangements. Modules are supplied with the appropriate and specified MIL-C-39029/22 socket contacts.



Feedback Modules
Feedthru Modules
Distribution Modules



Board Mount Modules



Ground Modules



Sealed Splices



Mounting Tracks

Key Features and Benefits

Improved Performance

Significant Amphenol Pcd design innovations over conventional Series II systems assure superior performance in wire sealing, contact alignment and retention, and module extraction.

Feedback Modules

The SJM feedback modules and mounting track system offer a lightweight junction system with a full range of bussing arrangements.

Distribution Modules

Distribution modules provide a variety of contact combinations for power distribution applications and have the same construction and features as the standard Series II modules.

Ground Modules

SJM grounding modules are available in both center stud and mounting flange versions.

Board Mount Pin Modules

The socket junction modules indicate on the following pages can also be provided in a solder pin version for mounting directly to printed circuit boards, providing a flexible, compact wiring package and eliminating the need for mounting track.



Military Qualified, QPL-Listed MIL-T-81714 Series II, Class D

Socket Junction Modules

Military P/N	Amphenol Pcd P/N	Page
M81714/60-22-01	SJM022100	49
M81714/60-22-02	SJM022200	49
M81714/60-22-04	SJM022400	49
M81714/60-22-05	SJM022500	49
M81714/60-22-06	SJM022600	49
M81714/60-22-10	SJM022700	49
M81714/60-20-01	SJM020100	50
M81714/60-20-02	SJM020200	50
M81714/60-20-03	SJM020300	50
M81714/60-20-04	SJM020400	50
M81714/60-20-06	SJM020600	50
M81714/60-16-01	SJM016100	51
M81714/60-16-02	SJM016200	51
M81714/60-16-03	SJM016300	51
		51
M81714/60-12-01	SJM012100	51
M81714/60-12-02	SJM012200	51
M81714/60-12-03	SJM012300	51
M81714/61-0Z	SJM000100	52
M81714/61-0Y	SJM000800	52
M81714/61-0X	SJM000200	52
M81714/61-0W	SJM000300	52

Socket Grounding Modules

Military P/N	Amphenol Pcd P/N	Page
M81714/63-22S	SJG022170	54
M81714/63-20S	SJG020170	54
M81714/63-16S	SJG016170	54
M81714/63-22F	SJG022270	55
M81714/63-20F	SJG020270	55
M81714/63-16F	SJG016270	55
M81714/63-12F	SJG016270	55

Socket Junction Module Mounting Track

Military P/N	Amphenol Pcd P/N	Page
M81714/67-02	SJT502404	59
M81714/67-03	SJT503404	59
M81714/67-04	SJT504404	59
M81714/67-05	SJT505404	59
M81714/67-06	SJT506404	59
M81714/67-07	SJT507404	59
M81714/67-08	SJT508404	59
M81714/67-09	SJT509404	59
M81714/67-10	SJT510404	59
M81714/67-12	SJT512404	59
M81714/67-13	SJT513404	59
M81714/67-14	SJT514404	59
M81714/67-15	SJT515404	59
M81714/67-16	SJT516404	59
M81714/67-18	SJT518404	59
M81714/67-19	SJT519404	59
M81714/67-20	SJT520404	59
M81714/67-21	SJT521404	59
M81714/67-25	SJT525404	59
M81714/67-30	SJT530404	59
M81714/67-32	SJT532404	59
M81714/67-40	SJT540404	59

In-Line Junction Splices

Military P/N	Amphenol Pcd P/N	Page
M81714/65-16-1	SJS316700	58
M81714/65-20-1	SJS320700	58
M81714/65-22-1	SJS322700	58
M81714/65-16-2	SJS316701	58
M81714/65-20-2	SJS320701	58
M81714/65-22-2	SJS322701	58

M81714/60-22

Series II Size 22

Operating Range

Temperature:

-65°C to 200°C

Insulation Resistance:

5000 Megaohms @ 25°C

Dielectric Withstanding Voltage:

1500 VRMS at Sea Level

200 VRMS at 110,000 ft.

Current Rating

5 Amps

Vibration & Shock:

MIL-T-81714 Paragraph

3.5.5 and 3.5.8

Materials

Module Body:

Polytherimide per ASTM-D5205

Grommet:

Silicone Blend Elastomer per A-A-59588

Contact Retainers:

Stainless Steel

Internal Pin and Socket Contacts:

Copper Alloy, Hard Gold Plated in

Accordance with MIL-G-45204

Socket Junction Modules

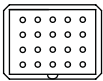
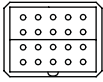
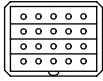
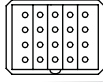
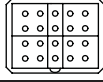
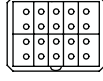

Amphenol Pcd Socket Junction Modules

Bussing Configurations	Part Numbers		Contact		
	Military P/N	APCD P/N	QTY*	Size ¹	P/N M39029
	M81714/60-22-01	SJM022100	20	22/22	/22-191
	M81714/60-22-02	SJM022200	20	22/22	/22-191
	M81714/60-22-04	SJM022400	20	22/22	/22-191
	M81714/60-22-05	SJM022500	20	22/22	/22-191
	M81714/60-22-06	SJM022600	20	22/22	/22-191
	M81714/60-22-07	SJM022700	20	22/22	/22-191

* Quantity figure denotes number of contacts accommodated by module. Modules are supplied with one additional spare contacts and two sealing plugs.

¹ Mating End / Wire Barrel.

Socket Junction Module Dimensions

Front & Side View

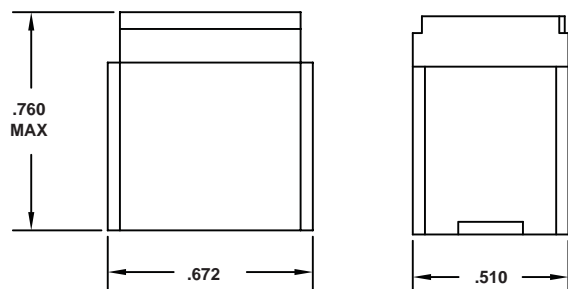

Top View

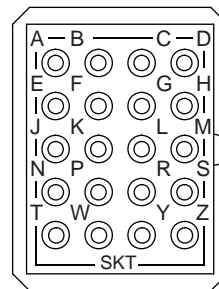

M81714/60-22-01 SHOWN



Amphenol Pcd

Socket Junction Modules

M81714/60-20

Series II Size 20



Operating Range

Temperature:

-65°C to 200°C

Insulation Resistance:

5000 Megaohms @ 25°C

Dielectric Withstanding Voltage:

1500 VRMS at Sea Level

200 VRMS at 110,000 ft.

Current Rating

7.5 Amps

Vibration & Shock:

MIL-T-81714 Paragraph

3.5.5 and 3.5.8

Materials

Module Body:

Polyetherimide per ASTM-D5205

Grommet:

Silicone Blend Elastomer per A-A-59588

Contact Retainers:

Stainless Steel

Internal Pin and Socket Contacts:

Copper Alloy, Hard Gold Plated in

Accordance with MIL-G-45204

Amphenol Pcd Socket Junction Modules

Bussing Configurations	Part Numbers		Contact		
	Military P/N	APCD P/N	QTY*	Size ¹	P/N M39029
	M81714/60-20-01	SJM020100	12	20/20	/22-192
	M81714/60-20-02	SJM020200	12	20/20	/22-192
	M81714/60-20-03	SJM020300	12	20/20	/22-192
	M81714/60-20-04	SJM020400	12	20/20	/22-192
	M81714/60-20-06	SJM020600	12	20/20	/22-192

* Quantity figure denotes number of contacts accommodated by module. Modules are supplied with one additional spare contacts and two sealing plugs.
¹ Mating End / Wire Barrel.



Socket Junction Module Dimensions

Front & Side View

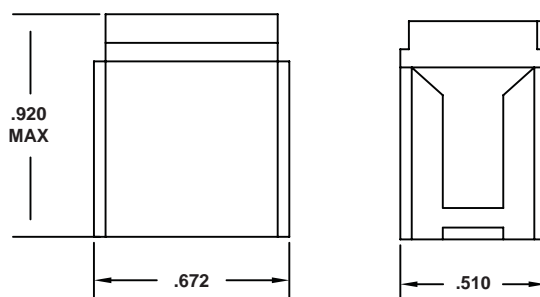

Top View

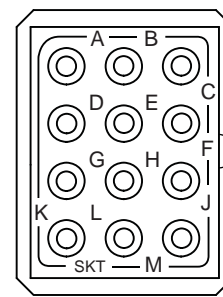

M81714/60-20-01 SHOWN

M81714/60-16

Series II Size 16

Operating Range

Temperature:

-65°C to 200°C

Insulation Resistance:

5000 Megaohms @ 25°C

Dielectric Withstanding Voltage:

1500 VRMS at Sea Level

200 VRMS at 110,000 ft.

Current Rating

13 Amps

Vibration & Shock:

MIL-T-81714 Paragraph

3.5.5 and 3.5.8

Materials

Module Body:

Polyetherimide per ASTM-D5205

Grommet:

Silicone Blend Elastomer per A-A-59588

Contact Retainers:

Stainless Steel

Internal Pin and Socket Contacts:

Copper Alloy, Hard Gold Plated in
Accordance with MIL-G-45204

Socket Junction Modules



Amphenol Pcd Socket Junction Modules

Bussing Configurations	Part Numbers		Contact		
	Military P/N	APCD P/N	QTY*	Size ¹	P/N M39029
	M81714/60-16-01	SJM016100	6	16/16	/22-193
	M81714/60-16-02	SJM016200	6	16/16	/22-193
	M81714/60-16-03	SJM016300	6	16/16	/22-193

* Quantity figure denotes number of contacts accommodated by module. Modules are supplied with one additional spare contacts and two sealing plugs.

¹ Mating End / Wire Barrel.

Socket Junction Module Dimensions

Front & Side View

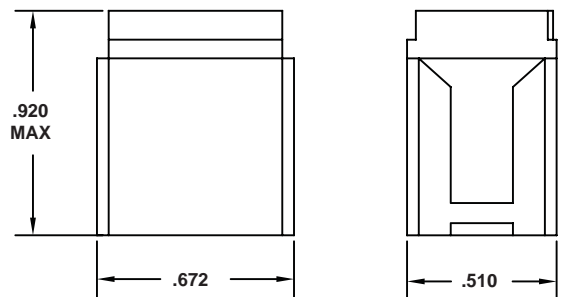

Top View

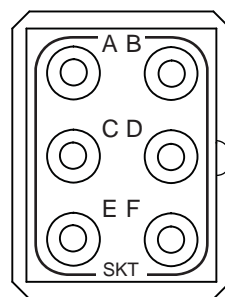

M81714/60-16-01 SHOWN



Amphenol Pcd

Socket Junction Modules

M81714/60-12

Series II Size 12



Operating Range

Temperature:

-65°C to 200°C

Insulation Resistance:

5000 Megaohms @ 25°C

Dielectric Withstanding Voltage:

1500 VRMS at Sea Level

200 VRMS at 110,000 ft.

Current Rating

23 Amps

Vibration & Shock:

MIL-T-81714 Paragraph

3.5.5 and 3.5.8

Materials

Module Body:

Polyetherimide per ASTM-D5205

Grommet:

Silicone Blend Elastomer per A-A-59588

Contact Retainers:

Stainless Steel

Internal Pin and Socket Contacts:

Copper Alloy, Hard Gold Plated in

Accordance with MIL-G-45204

Amphenol Pcd Socket Junction Modules

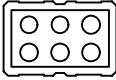
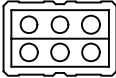
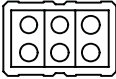
Bussing Configurations	Part Numbers		Contact		
	Military P/N	APCD P/N	QTY*	Size ¹	P/N M39029
	M81714/60-12-01	SJM012100	6	12/12	/22-605
	M81714/60-12-02	SJM012200	6	12/12	/22-605
	M81714/60-12-03	SJM012300	6	12/12	/22-605

* Quantity figure denotes number of contacts accommodated by module. Modules are supplied with one additional spare contacts and two sealing plugs.

¹ Mating End / Wire Barrel.



Socket Junction Module Dimensions

Front & Side View

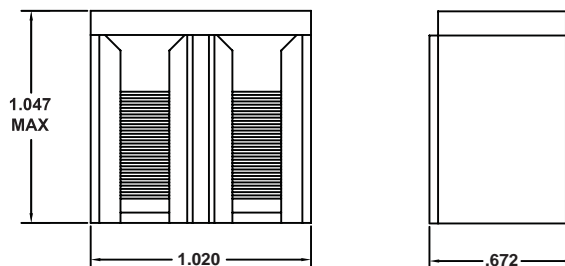

Top View



M81714/60-12-01 SHOWN

M81714/61 Series II

Distribution Socket Junction Modules

Socket Junction Modules

Operating Range

Temperature:

-65°C to 200°C

Insulation Resistance:

5000 Megaohms @ 25°C

Dielectric Withstanding Voltage:

1500 VRMS at Sea Level

200 VRMS at 110,000 ft.

Current Rating

5 Amps (Size 22)

7.5 Amps (Size 20)

13 Amps (Size 16)

23 Amps (Size 12)

Vibration & Shock:

MIL-T-81714 Paragraph

3.5.5 and 3.5.8

Materials

Module Body:

Polyetherimide per ASTM-D5205

Grommet:

Silicone Blend Elastomer per A-A-59588

Contact Retainers:

Stainless Steel

Internal Pin and Socket Contacts:

Copper Alloy, Hard Gold Plated in Accordance with MIL-G-45204



Amphenol Pcd Socket Junction Modules

Bussing Configurations	Part Numbers		QTY	Contact		Bussing
	Military P/N	APCD P/N		Size	P/N M39029	Bus Description
	M81714/61-0Z	SJM000100	6	16	/22-193	1 BUS TWO SIZE 12 & SIX SIZE 16
			2	12	/22-605	
	M81714/61-0Y	SJM000800	6	20	/22-192	1 BUS TWO SIZE 16 & SIX SIZE 20
			2	16	/22-193	
	M81714/61-0X	SJM000200	6	16	/22-193	2 BUSES ONE SIZE 12 & THREE SIZE 16 PER BUS
			2	12	/22-605	
	M81714/61-0W	SJM000500	5	22	/22-191	5 BUSES ONE SIZE 22 & ONE SIZE 20 & ONE SIZE 16 PER BUS
			5	20	/22-192	
			5	16	/22-193	

Socket Junction Module Dimensions

Front View

M81714/61-0Y

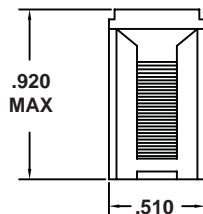

M81714/61-0Z, M81714/61-0X, M81714/61-0W



Side View

M81714/61-0Y

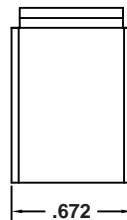

M81714/61-0Z, M81714/61-0X, M81714/61-0W

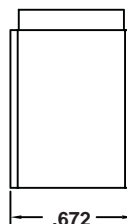

Product Description

Distribution Socket Junction Modules are available in a variety of MIL-T-81714 configurations, feature the same construction and features as the standard Series II high density modules, and are recommended for power distribution applications



Amphenol Pcd

M81714/63 Socket Ground Modules

Stud Mount Series II Size 16, 20, 22

Socket Junction Modules



Operating Range

Temperature:
-65°C to 200°C

Current Rating
5 Amps (Size 22)
7.5 Amps (Size 20)
13 Amps (Size 16)

Vibration & Shock:
MIL-T-81714 Paragraph
3.5.5 and 3.5.8

Materials

Module Body:
Polyetherimide per ASTM-D5205

Grommet:
Silicone Blend Elastomer per A-A-59588

Stud / Shell:
Copper Alloy, Gold Plated per
SAE-AMS-2422. Tin Plating per
ASTM-B545 Also Available as an Alternate

Contact Retainers:
Stainless Steel

Socket Contacts:
Copper Alloy, Hard Gold Plated in
Accordance with MIL-G-45204

Socket Grounding Modules Part Numbers

Product Description

M81714/63, stud mount, socket grounding modules mount directly to a ground plane or ground lug creating a multi-wire sealed grounding device. The grounding modules could also be mounted to a bus bar for power distribution, sensing or metering. All mounting hardware is furnished and custom hardware configurations are available. The mounting stud is available in gold or tin plating.

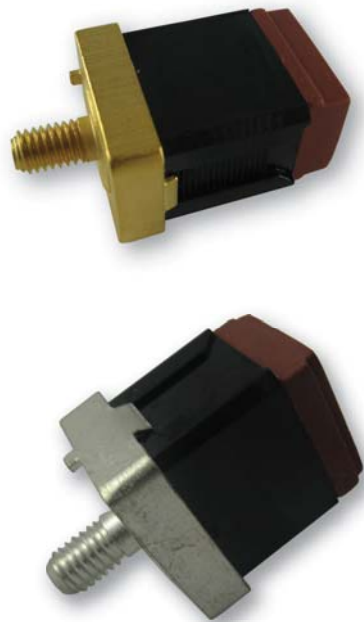

Part Numbers			Contact		Stud
Military P/N	APCD P/N	QTY*	Size ¹	P/N M39029	Plating
M81714/63-22S	SJG022170	20	22/22	/22-191	Gold
	SJG022100	20	22/22	/22-191	Tin
M81714/63-20S	SJG020170	12	20/20	/22-192	Gold
	SJG020100	12	20/20	/22-192	Tin
M81714/63-16S	SJG016170	6	16/16	/22-193	Gold
	SJG016100	6	16/16	/22-193	Tin

* Quantity figure denotes number of contacts accommodated by module. Modules are supplied with one additional spare contacts and two sealing plugs

¹ Mating End/ Wire Barrel

Socket Junction Module Dimensions

Top View

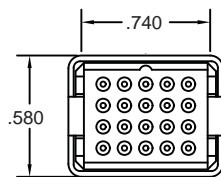

Size 22

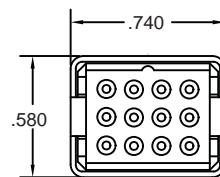

Size 20

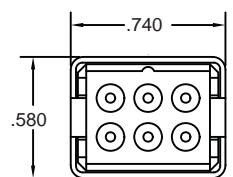

Size 16

Side View

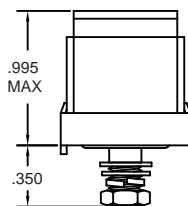

Size 22

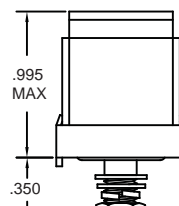

Size 20

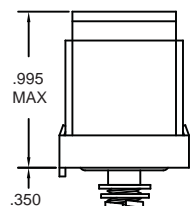

Size 16

M81714/63 Socket Ground Modules

Flange Mount Series II Size 12, 16, 20, 22

Operating Range

Temperature:

-65°C to 200°C

Current Rating

5 Amps (Size 22)

7.5 Amps (Size 20)

13 Amps (Size 16)

23 Amps (Size 12)

Vibration & Shock:

MIL-T-81714 Paragraph

3.5.5 and 3.5.8

Materials

Module Body:

Polyetherimide per ASTM-D5205

Grommet:

Silicone Blend Elastomer per A-A-59588

Flange / Shell:

Copper Alloy, Gold Plated per SAE-AMS-2422. Tin Plating per ASTM-B545 Also Available as an Alternate

Contact Retainers:

Stainless Steel

Socket Contacts:

Copper Alloy, Hard Gold Plated in Accordance with MIL-G-45204

Socket Junction Modules



Socket Grounding Modules Part Numbers

Part Numbers			Contact		Flange
Military P/N	APCD P/N	QTY*	Size ¹	P/N M39029	Plating
M81714/63-22F	SJG022270	20	22/22	/22-191	Gold
	SJG022200	20	22/22	/22-191	Tin
M81714/63-20F	SJG020270	12	20/20	/22-192	Gold
	SJG020200	12	20/20	/22-192	Tin
M81714/63-16F	SJG016270	6	16/16	/22-193	Gold
	SJG016200	6	16/16	/22-193	Tin
M81714/63-12F	SJG012270	6	12/12	/22-605	Gold
	SJG012200	6	12/12	/22-605	Tin

* Quantity figure denotes number of contacts accommodated by module. Modules are supplied with one additional spare contacts and two sealing plugs

¹ Mating End/ Wire Barrel

Product Description

M81714/ 63, flange mount, socket grounding modules mount directly to a ground plane or ground lug creating a multi-wire sealed grounding device. The grounding modules could also be mounted to a bus bar for power distribution, sensing or metering. All mounting hardware is furnished and custom hardware configurations are available. The mounting stud is available in gold or tin plating.

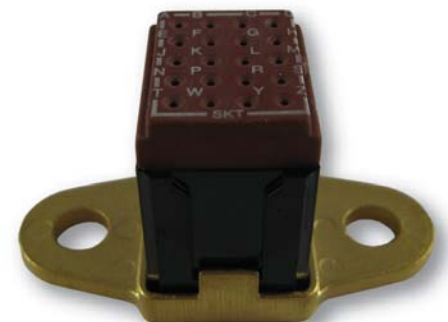

Socket Junction Module Dimensions

Top View

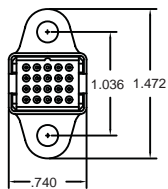

Size 22

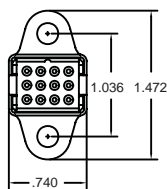

Size 20

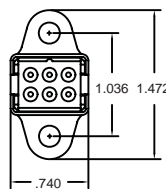

Size 16

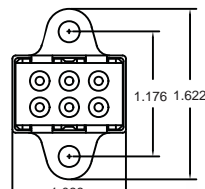

Size 12

Side View

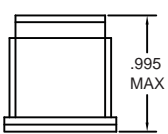

Size 22

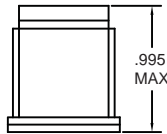

Size 20



Size 16

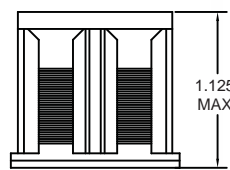

Size 12

Amphenol Pcd

Socket Junction Modules



Board Mount Socket Junction Modules Series II Size 12, 16, 20, 22

Operating Range

Temperature:

-65°C to 125°C

Insulation Resistance:

1000 Megaohms Min.

Dielectric Withstanding Voltage:

1500 VRMS at Sea Level

200 VRMS at 80,000 ft.

Current rating:

5 Amps (Size 22)

7.5 Amps (Size 20)

13 Amps (Size 16)

23 Amps (Size 12)

Materials

Module Body:

Polytherimide per ASTM-D5205

Grommet:

Silicone Blend Elastomer per A-A-59588

Contact Retainers:

Stainless Steel

Socket Contacts:

Copper Alloy, Hard Gold Plated in

Accordance with MIL-G-45204

Product Description

The socket junction modules indicate on the following pages can also be provided in a solder pin version for mounting directly to printed circuit boards, providing a flexible, compact wiring package and eliminating the need for mounting track. Please contact Amphenol Pcd for details on the SJP pin module.

Module Configurations

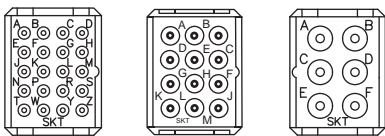

A

B

C



Board Mount Socket Junctions

APCD P/N	QTY	Size	Contact P/N	Config.	DIM. L
SJP022000	20	22/22	M39029/22-191	A	.187
SJP022010	20	22/22	M39029/22-191	A	.250
SJP020000	12	20/20	M39029/22-192	B	.187
SJP020010	12	20/20	M39029/22-192	B	.250
SJP016000	6	16/16	M39029/22-193	C	.187
SJP016010	6	16/16	M39029/22-193	C	.250
SJP012000	6	12/12	M39029/22-605	D	.187
SJP012010	6	12/12	M39029/22-605	D	.250
SJP012010	6	12/12	M39029/22-605	D	.335

Board Mount Socket Junction Modules Dimensions

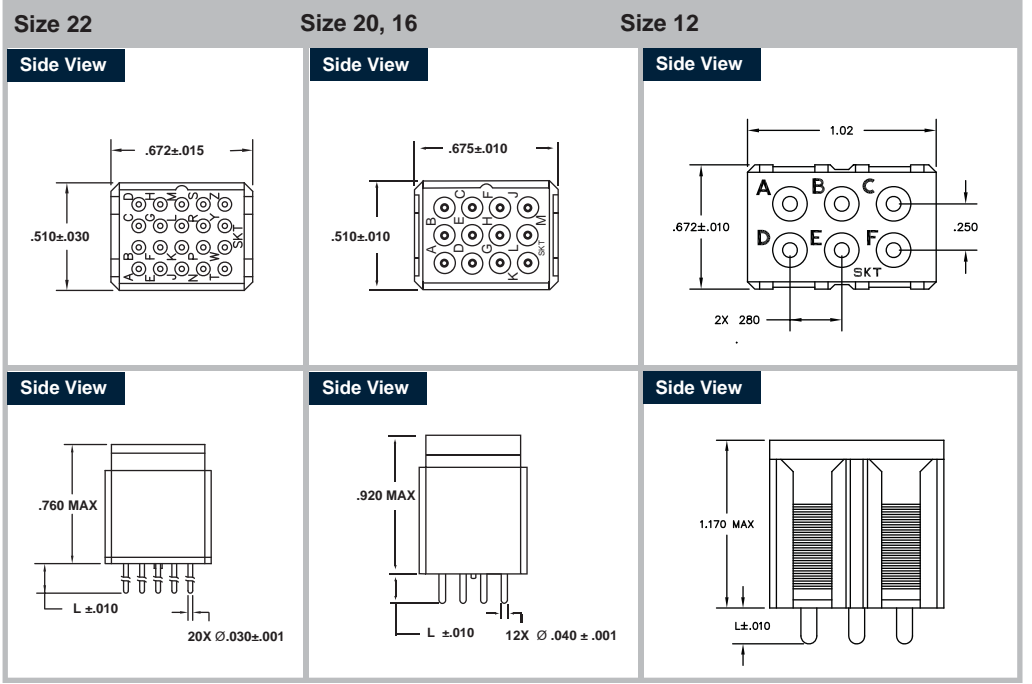

Electronic Socket Junction Modules

SJE Component Modules

Operating Range

Temperature:

-65°C to 200°C

Insulation Resistance:

5000 Megaohms Min.

Dielectric Withstanding Voltage:

1500 VRMS at Sea Level

200 VRMS at 100,000 ft.

Vibration & Shock:

Per MIL-T-81714

Paragraph 3.5.5 & 3.5.8

Materials

Insulator Body:

Polyetherimide per ASTM-D-5205

Grommet:

Silicone Rubber per A-A-59588

Internal Contact:

Copper Alloy, Gold Finish

per SAE-AMS-MIL-G-45204

Socket Junction Modules



Electronic Socket Junction Modules

Circuit Diagram	APCD P/N	Component	Quantity
	SJE020001	Diode	5
	SJE020003	Diode	4
	SJE020006	Resistor	5
	SJE020008	Diode	2
	SJE020009	Diode	5
	SJE020016	Diode	5
	SJE020017	Resistor	4
	SJE020022	Diode	5
	SJE020045	Diode	5
	SJE020290	Resistor	2
	SJE020297	Fuse	5

Product Descriptions

Amphenol Pcd's Electronic Socket Junction Modules are available with a variety of components and in a wide range of configurations. Components available include, but are not limited to, diodes, resistors, fuses, thyristors, and inductors, and are also available with multiple components within one module. There are new configurations produced regularly and customized components are also available.

Junction Module Dimensions

Side View

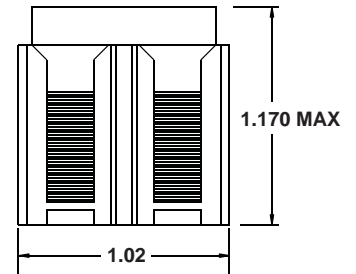

Top View



Amphenol Pcd

M81714/65 Sealed In-Line Splices

SJS Series II Single and Double

Socket Junction Splices



Operating Range

Temperature:
-65°C to 200°C

Insulation Resistance:
5000 Megaohms Min.

Dielectric Withstanding Voltage:
1500 VRMS at Sea Level
200 VRMS at 100,000 ft.

Vibration & Shock:
Per MIL-T-81714
Paragraph 3.5.5 & 3.5.8

Current Rating:
13 Amps (Size 16)
7.5 Amps (Size 20)
5 Amps (Size 22)

Materials

Insulator Body:
Polyetherimide per ASTM-D-5205

Grommet:
Silicone Rubber per A-A-59588

Internal Contact:
Copper Alloy, Gold Finish
Accordance with MIL-G-45204

Product Description

Series II In-Line Splices are available in single and double configurations in sizes 16, 20, and 22 AWG. These M81714/65 Splices use the same advanced polyetherimide body, one-piece bus assembly and construction as Amphenol Pcd's other M81714 connectors.

Single SJS Splices

	Military P/N	APCD P/N	Ø Diameter
	M81714/65-16-1	SJS316700	.324 Max
	M81714/65-20-1	SJS320700	.290 Max
	M81714/65-22-1	SJS322700	.230 Max

Sealed Splice Contacts

In-Line Splice	Contact
M81714/65-16-1	M39029/22-193
M81714/65-20-1	M39029/22-192
M81714/65-22-1	M39029/22-191
M81714/65-16-2	M39029/22-193
M81714/65-20-2	M39029/22-192
M81714/65-22-2	M39029/22-191

Double SJS Splices

	Military P/N	APCD P/N	A	B	C
	M81714/65-16-2	SJS316701	.548 Max	.304 Max	.180 Max
	M81714/65-20-2	SJS320701	.481 Max	.271 Max	.150 Max
	M81714/65-22-2	SJS322701	.384 Max	.204 Max	.120 Max

Splice Dimensions

SJS Single Splice

Side View

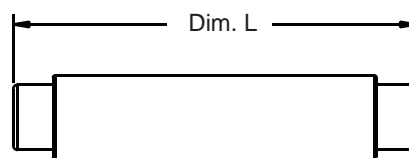

Wire Size Dimension L

Size 16	1.452 Max
Size 20	1.434 Max
Size 22	1.310 Max

SJS Double Splice

Side View

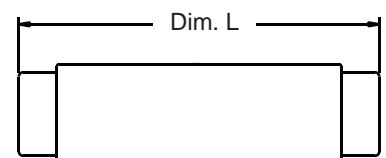

Wire Size Dimension L

Size 16	1.428 Max
Size 20	1.428 Max
Size 22	1.322 Max

M81714/67 Series II

Socket Junction Module Mounting Tracks

Operating Range

Temperature:

-65° to 200°C

Corrosion:

No Exposure of Base Metal
After 48 Hours of Salt Spray

Magnetic Permeability:

2.0 MU Max.

Vibration and Shock:

Per MIL-T-81714 Paragraph

3.5.5 and 3.5.8

Materials

Rail:

Aluminum Alloy, Black Anodized

Spring Clips:

Stainless Steel

Rivets:

Stainless Steel

Socket Junction Modules



Socket Junction Modules Mounting Tracks

Military P/N	APCD	Mounting Pos.*	Dimensions	
			A	B
M81714/67-02	SJT502404	2	1.036	0.518
M81714/67-03	SJT503404	3	1.554	1.036
M81714/67-04	SJT504404	4	2.072	1.554
M81714/67-05	SJT505404	5	2.590	2.072
M81714/67-06	SJT506404	6	3.108	2.590
M81714/67-07	SJT507404	7	3.626	3.108
M81714/67-08	SJT508404	8	4.144	3.626
M81714/67-09	SJT509404	9	4.662	4.144
M81714/67-10	SJT510404	10	5.180	4.662
M81714/67-12	SJT512404	12	6.216	5.698
M81714/67-13	SJT513404	13	6.734	6.216
M81714/67-14	SJT514404	14	7.252	6.734
M81714/67-15	SJT515404	15	7.770	7.252
M81714/67-16	SJT516404	16	8.288	7.770
M81714/67-18	SJT518404	18	9.324	8.806
M81714/67-19	SJT519404	19	9.842	9.324
M81714/67-20	SJT520404	20	10.360	9.842
M81714/67-21	SJT521404	21	10.878	10.360
M81714/67-25	SJT525404	25	12.950	12.432
M81714/67-30	SJT530404	30	15.540	15.022
M81714/67-32	SJT532404	32	16.576	16.058
M81714/67-40	SJT540404	40	20.720	20.202

*Size 12 Modules require two mounting positions

Removal Tools

MIL P/N	APCD P/N	Description
M81714/69-01	CNA051300	Single
M81714/69-02	CNA052300	Double

Removal Tools

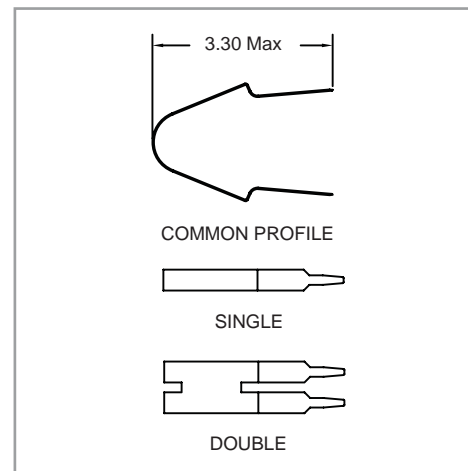

Socket Junction Track Dimensions

Top View

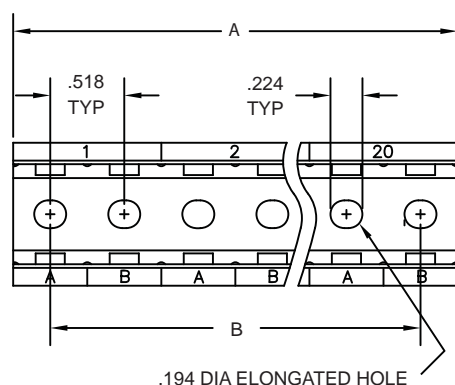

Cross Section

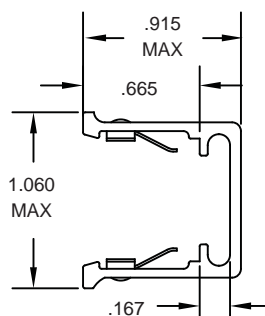

Amphenol Pcd

M81714/67 Series II

Composite Socket Junction Module Mounting Tracks

Socket Junction Modules



Operating Range

Temperature:

-65° to 175°C

Vibration and Shock:

Per MIL-T-81714 Paragraph

3.5.5 and 3.5.8

Materials

Rail:

Glass Filled Polyetherimide,

Color: Black

Product Description

The SJTC Mounting Track is fabricated of glass-filled polyetherimide which was selected for its unique combination of high strength, lightweight, chemical resistance and dimensional stability. The track is available with 2 through 20 mounting positions and is inter-changeable with existing aluminum track. The new track is 45% lighter than the aluminum track and 10% lighter than any other series II track available, and meets all dimensional requirements of MIL-T-81714.

Composite Socket Junction Module Mounting Tracks

Military Equivalent P/N	APCD P/N	Mounting Pos.	Dimensions	
			A	B
M81714/67-02	SJTC02000	2	1.036	0.518
M81714/67-03	SJTC03000	3	1.554	1.036
M81714/67-04	SJTC04000	4	2.072	1.554
M81714/67-05	SJTC05000	5	2.590	2.072
M81714/67-06	SJTC06000	6	3.108	2.590
M81714/67-07	SJTC07000	7	3.626	3.108
M81714/67-08	SJTC08000	8	4.144	3.626
M81714/67-09	SJTC09000	9	4.662	4.144
M81714/67-10	SJTC10000	10	5.180	4.662
	SJTC11000	11	5.698	5.180
M81714/67-12	SJTC12000	12	6.216	5.698
M81714/67-13	SJTC13000	13	6.734	6.216
M81714/67-14	SJTC14000	14	7.252	6.734
M81714/67-15	SJTC15000	15	7.770	7.252
M81714/67-16	SJTC16000	16	8.288	7.770
	SJTC17000	17	8.806	8.288
M81714/67-18	SJTC18000	18	9.324	8.806
M81714/67-19	SJTC19000	19	9.842	9.324
M81714/67-20	SJTC20000	20	10.360	9.842

*Size 12 Modules require two mounting positions

Removal Tools

MIL P/N	APCD P/N	Description
M81714/69-01	CNA051300	Single
M81714/69-02	CNA052300	Double

Removal Tools



COMMON PROFILE



SINGLE



DOUBLE

Composite Socket Junction Module Mounting Tracks

Top View

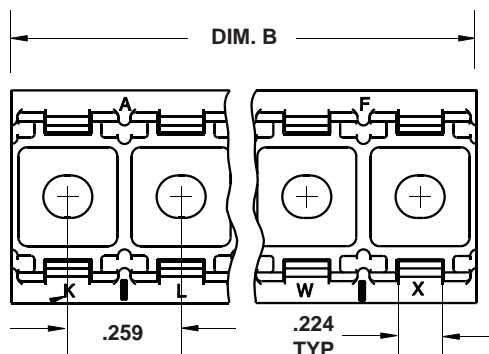

Cross Section

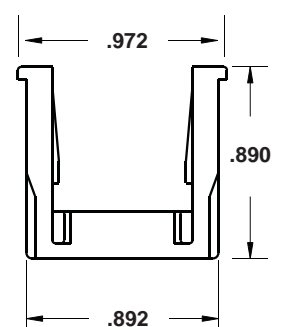

Wire Junctions and System Attachments

MIL-T-81714, M39029, Cable Supports

Wire Junctions and Attachments

Amphenol Pcd offers a variety of Junctions, Splices, Contacts, and Attachments for a wide range of wiring applications. Amphenol Pcd welcomes customer inquiries regarding customization of existing products as well as inquiries about new products. Amphenol Pcd is committed to providing complete solutions to all interconnect requirements.



SJS In-Line Junctions



High Performance Clamps



Military Specification Contacts

Product features and Benefits

SJS In-Line Junctions

Environmentally sealed In-Line Junction Splices developed to bring higher reliability, improved installation ease, and greater flexibility to wiring applications.

High Performance Clamps

High Performance Clamps are designed to replace and outperform traditional P-Clamps & Saddle Clamps. Consisting of VICTREX® PEEK™ polymer and featuring and over-molded silicone cushion, these clamps are completely non-corrosive and non-conductive. These High Performance Clamps are designed to be lighter than traditional P-Clamps and are equipped with a locking feature to streamline installation.

Military Specification Contacts

Amphenol Pcd offers contacts for almost every connector, module or socket they produce. Contacts can be purchased with the parts or separately.

SJS In-Line Junctions



Single Contact In-Line Junction

SJS Plugs & Receptacles Size 16, 20

Operating Range

Temperature:

-55°C to 155°C

Insulation Resistance:

5000 Megaohms Min.

Dielectric Withstanding Voltage:

1500 VRMS at Sea Level

600 VRMS at 45,000 ft.

Vibration:

EIA-364D-028D, Test Condition V, E

Sealing:

EIA-364D-03B (55,000 ft)

Flammability Rating:

UL94, V0

CTI Rating:

UL746B, 600V

Contact Retention:

EIA-364D-029B (20lb)

Materials

Insulator Body:

Polyamide (Nylon)

Grommet:

Silicone Rubber per A-A-59588

Contact Retainers:

Stainless Steel

Product Description

Two-piece environmentally sealed In-Line Junction designed to bring higher reliability, improved installation ease, and greater flexibility to wiring applications. Developed to meet MIL-T-81714 criteria, these in-line junctions consist of compact cylindrical plug and receptacle housing, which lock firmly together with a straight push and unlock with a simple "Twist and Pull" motion. In-Line Junctions are available with protective dust covers and are available in two colors per size. Wire Size 12 SJS and panel mount versions are currently in development.

In-Line Junction Plugs

Size	Part No.	Length		Diameter		Mated Length		Color
		inch	cm	inch	cm	inch	cm	
16	SJS716100	1.13	2.87	0.39	0.99	1.65	4.20	Blue
	SJS716110							Red
20	SJS720100	1.11	2.81	0.39	0.99	1.70	4.30	Green
	SJS720110							Yellow

In-Line Junction Contacts

In-Line Junction	Contact
Size 16 Plugs	M39029/56-352 (socket)
Size 16 Receptacles	M39029/56-351 (socket)
Size 20 Plugs	M39029/58-364 (pin)
Size 20 Receptacles	M39029/58-363 (pin)

In-Line Junction Receptacles

Size	Part No.	Length		Diameter		Mated Length		Color
		inch	cm	inch	cm	inch	cm	
16	SJS716200	1.06	2.69	0.43	1.09	1.65	4.20	Blue
	SJS716210							Red
20	SJS720200	1.03	2.61	0.39	0.99	1.70	4.30	Green
	SJS720210							Yellow

In-Line Junction Weight

In-Line Junction	Pounds	Grams
SJS716100	.0037	1.70
SJS716200	.0031	1.40
SJS720100	.0033	1.50
SJS720200	.0026	1.20

In Line Junction Dimensions

In-Line Junction Plug Dimensions

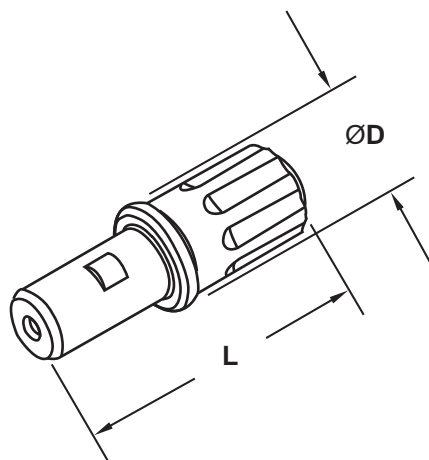

In-Line Junction Receptacle Dimensions

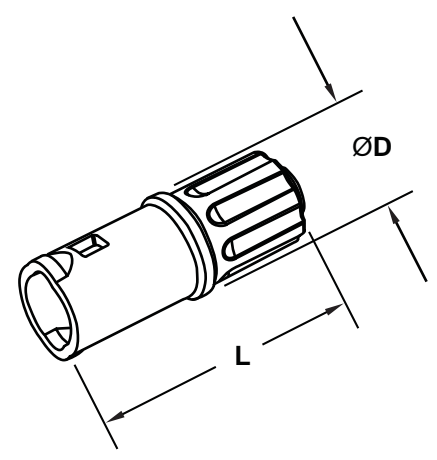

Triple Contact In-Line Junction

SJS Plugs & Receptacles Size 16, 20

Operating Range

Temperature:

-55°C to 155°C

Insulation Resistance:

5000 Megaohms Min.

Dielectric Withstanding Voltage:

1500 VRMS at Sea Level

600 VRMS at 45,000 ft.

Vibration:

EIA-364D-028D, Test Condition V, E

Sealing:

EIA-364D-03B (55,000ft)

Flammability Rating:

UL94, V0

CTI Rating:

UL746B, 600V

Contact Retention:

EIA-364D-029B (20lb)

Materials

Insulator Body:

Polyamide (Nylon)

Grommet:

Silicone Rubber per A-A-59588

Contact Retainers:

Stainless Steel

SJS In-Line Junctions



Product Description

Two-piece environmentally sealed In-Line Junction designed to bring higher reliability, improved installation ease, and greater flexibility to wiring applications. Developed to meet MIL-T-81714 criteria, these in-line junctions consist of compact cylindrical plug and receptacle housing, which lock firmly together with a straight push and unlock with a simple "Squeeze and Pull" motion. The In-Line Junctions are keyed according to color and size and are available in three colors per size. Protective dust caps are also available. A panel mount version is currently in development

In-Line Junction Plugs

Size	Part No.	Length		Diameter		Mated Length		Key	Color
		inch	cm	inch	cm	inch	cm		
16	SJS816100	1.12	2.84	0.70	1.78	1.60	4.10	A	Red
	SJS816110							B	White
	SJS816120							C	Blue
20	SJS820100	1.08	2.74	0.70	1.78	1.68	4.30	A	Red
	SJS820110							B	White
	SJS820120							C	Blue

In-Line Junction Receptacles

Size	Part No.	Length		Diameter		Mated Length		Key	Color
		inch	cm	inch	cm	inch	cm		
16	SJS816200	1.03	2.61	0.70	1.78	1.60	4.10	A	Red
	SJS816210							B	White
	SJS816220							C	Blue
20	SJS820200	0.99	2.51	0.70	1.78	1.68	4.30	A	Red
	SJS820210							B	White
	SJS820220							C	Blue

In-Line Junction Contacts

In-Line Junction	Contact
Size 16 Plugs	M39029/56-352 (socket)
Size 16 Receptacles	M39029/56-351 (socket)
Size 20 Plugs	M39029/58-364 (pin)
Size 20 Receptacles	M39029/58-363 (pin)

In-Line Junction Weight

In-Line Junction	Pounds	Grams
SJS816100	.0116	5.30
SJS816200	.0095	4.30
SJS820100	.0101	4.60
SJS820200	.0081	3.70

Relay Socket Dimensions

In-Line Junction Plug Dimensions

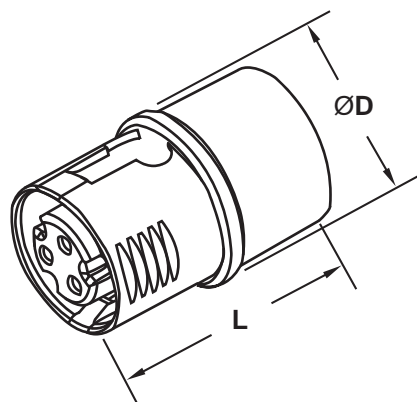

In-Line Junction Receptacle Dimensions

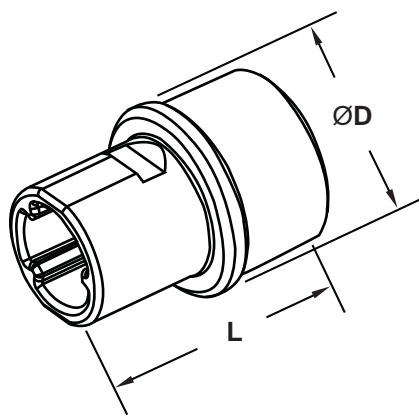

High Performance Clamps



High Performance P-Clamp

High Strength, Lightweight Wire & Tubing Clamps

Materials

Clamp Base:

Polyetheretherketone (PEEK™)
Per MIL-P-46183

Overmolding:

Silicone Rubber per ASTM-D-2000

Performance

Temperature Limits:

Continuous: -54°C to 107°C
Excursions: up to 177°C

Flammability:

UL94, V0

Product Description

High Performance P-Clamps are designed to replace and outperform traditional clamps. Consisting of PEEK™ polymer and featuring and over-molded silicone cushion, these clamps are completely non-corrosive and non-conductive. These high performance clamps are designed to be lighter than traditional P-Clamps, are equipped with a locking feature to streamline installation, and are available in 15 different sizes. Alternate cushioning material available upon request including Fluorosilicone for fuel tank applications.

P-Clamp Weight Chart

APCD P/N	Weight (lbs) per 100 Clamps	Weight (grams) per 100 Clamps
PCL150101	0.9	408
PCL150102	1.1	499
PCL150103	1.5	681
PCL150104	1.7	771
PCL150105	1.9	862
PCL150106	2.1	953
PCL150107	2.6	1180
PCL150108	2.9	1316
PCL150109	3.1	1407
PCL150110	3.3	1498
PCL150111	4.0	1816
PCL150112	4.4	1997
PCL150113	4.6	2088
PCL150114	5.2	2360
PCL150115	5.7	2587

High Performance P-Clamps

Amphenol Pcd Part Number	Diameter		F		L		H		T	
	Inch	cm	Inch	cm	Inch	cm	Inch	cm	Inch	cm
PCL150101	0.12	0.32	0.59	1.51	1.18	2.99	0.64	1.62	0.18	0.46
PCL150102	0.22	0.56	0.64	1.63	1.27	3.22	0.71	1.80	0.18	0.46
PCL150103	0.31	0.79	0.71	1.81	1.41	3.59	0.82	2.07	0.24	0.61
PCL150104	0.41	1.03	0.76	1.93	1.51	3.83	0.88	2.25	0.24	0.61
PCL150105	0.50	1.27	0.81	2.05	1.60	4.07	0.92	2.33	0.24	0.61
PCL150106	0.59	1.51	0.85	2.17	1.69	4.31	1.05	2.68	0.24	0.61
PCL150107	0.69	1.75	0.93	2.35	1.84	4.67	1.20	3.05	0.30	0.76
PCL150108	0.78	1.99	0.97	2.47	1.93	4.91	1.32	3.35	0.30	0.76
PCL150109	0.88	2.22	1.02	2.59	2.03	5.15	1.39	3.53	0.30	0.76
PCL150110	0.97	2.46	1.07	2.71	2.12	5.38	1.48	3.76	0.30	0.76
PCL150111	1.06	2.70	1.14	2.89	2.26	5.75	1.62	4.12	0.36	0.91
PCL150112	1.16	2.94	1.18	3.01	2.36	5.99	1.75	4.46	0.36	0.91
PCL150113	1.25	3.18	1.23	3.13	2.45	6.23	1.82	4.63	0.36	0.91
PCL150114	1.34	3.41	1.29	3.28	2.57	6.54	1.93	4.91	0.40	1.00
PCL150115	1.44	3.65	1.35	3.43	2.69	6.83	2.05	5.20	0.42	1.07

P-Clamp Dimensions

Side View

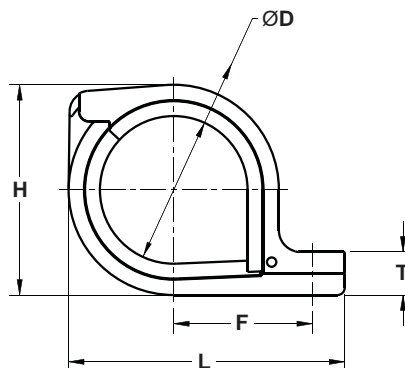

Bottom View

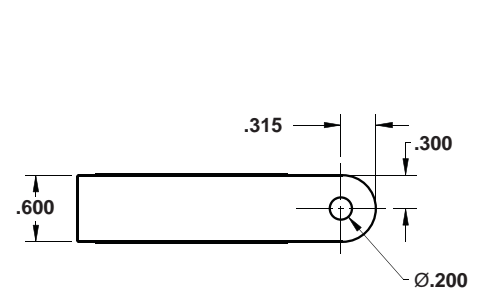

High Performance Omega Clamp

High Strength, Lightweight Wire & Tubing Clamps

Materials

Clamp Base:

Polyetheretherketone (PEEK™)
per MIL-P-46183

Overmolding:

Silicone Rubber per ASTM-D-2000

Performance

Temperature Limits:

Continuous: -54°C to 107°C
Excursions: up to 177°C

Flammability:

UL94, V0

High Performance Clamps



High Performance Omega Clamps

Amphenol Pcd Part Number	Diameter		L		F		H		C		E	
	Inch	cm	Inch	cm	Inch	cm	Inch	cm	Inch	cm	Inch	cm
PCL250008	0.45	1.14	2.19	5.56	0.78	1.98	0.91	2.31	1.56	3.96	0.20	0.51
PCL250009	0.51	1.30	2.25	5.72	0.81	2.06	0.97	2.46	1.62	4.11	0.20	0.51
PCL250010	0.57	1.45	2.31	5.87	0.84	2.13	1.03	2.62	1.68	4.27	0.20	0.51
PCL250011	0.63	1.60	2.42	6.15	0.89	2.26	1.14	2.90	1.79	4.55	0.25	0.64
PCL250012	0.70	1.78	2.49	6.32	0.93	2.36	1.21	3.07	1.86	4.72	0.25	0.64
PCL250013	0.77	1.96	2.56	6.50	0.96	2.44	1.28	3.25	1.93	4.90	0.25	0.64
PCL250014	0.83	2.11	2.62	6.65	1.00	2.54	1.34	3.40	1.99	5.05	0.25	0.64
PCL250015	0.89	2.26	2.68	6.81	1.03	2.62	1.40	3.56	2.05	5.21	0.25	0.64
PCL250016	0.95	2.41	2.79	7.09	1.08	2.74	1.51	3.84	2.16	5.49	0.30	0.76
PCL250017	1.01	2.57	2.85	7.24	1.11	2.82	1.57	3.99	2.22	5.64	0.30	0.76
PCL250018	1.07	2.72	2.91	7.39	1.14	2.90	1.63	4.14	2.28	5.79	0.30	0.76
PCL250019	1.13	2.87	2.97	7.54	1.17	2.97	1.69	4.29	2.34	5.94	0.30	0.76
PCL250020	1.20	3.05	3.07	7.80	1.22	3.10	1.79	4.55	2.44	6.20	0.33	0.84
PCL250021	1.26	3.20	3.10	7.87	1.24	3.15	1.82	4.62	2.47	6.27	0.30	0.76
PCL250022	1.33	3.38	3.17	8.05	1.27	3.23	1.89	4.80	2.54	6.45	0.30	0.76
PCL250023	1.39	3.53	3.23	8.20	1.30	3.30	1.95	4.95	2.60	6.60	0.30	0.76
PCL250024	1.45	3.68	3.29	8.36	1.33	3.38	2.01	5.11	2.66	6.76	0.30	0.76
PCL250025	1.51	3.84	3.35	8.51	1.36	3.45	2.07	5.26	2.72	6.91	0.30	0.76
PCL250026	1.57	3.99	3.41	8.66	1.39	3.53	2.13	5.41	2.78	7.06	0.30	0.76
PCL250032	1.95	4.95	3.82	9.70	1.60	4.06	2.54	6.45	3.19	8.10	0.33	0.84

Product Description

High Performance Omega Clamps are designed to replace and outperform traditional clamps. Consisting of PEEK™ polymer and featuring an over-molded silicone cushion, these clamps are completely non-corrosive and non-conductive. These high performance clamps are designed to be lighter than traditional Clamps, are equipped with a locking feature to streamline installation, and are available in 20 different sizes. Alternate cushioning material available upon request including Fluorosilicone for fuel tank applications.

Omega Clamp Weight Chart

APCD P/N	Weight (lbs) per 100 Clamps	Weight (grams) per 100 Clamps
PCL250008	2.0	907
PCL250009	2.1	952
PCL250010	2.2	997
PCL250011	2.9	1315
PCL250012	3.0	1360
PCL250013	3.2	1451
PCL250014	3.3	1496
PCL250015	3.4	1542
PCL250016	4.2	1905
PCL250017	4.4	1995
PCL250018	4.5	2041
PCL250019	4.7	2131
PCL250020	5.3	2404
PCL250021	5.0	2268
PCL250022	5.2	2358
PCL250023	5.3	2404
PCL250024	5.4	2449
PCL250025	5.6	2540
PCL250026	5.7	2585
PCL250032	7.3	3311

P-Clamp Dimensions

Side View

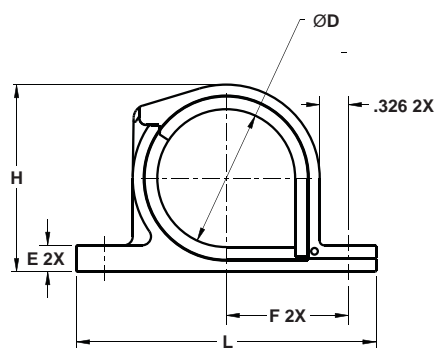

Bottom View

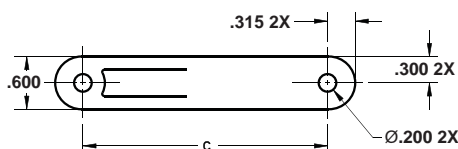

Power Distribution Bus



Power Bus 3

Power Distribution Bus

Materials
Module Body:
 Polyetherimide
 per ASTM-D5205
Color:
 Gray
Socket Contact Retainers:
 Beryllium Copper
Bus Bar and Pin Contacts:
 Copper, Nickel Plated per
 SAE-AMS-QQ-N-29C, Class I
Marking:
 High Temperature epoxy ink
 (Colors Optional)

Operating Range
Temperature:
 -55°C to 80°C
Voltage:
 1000 Volts AC RMS Max
Current:
 73 Amps Max
Vibration:
 MIL-STD-202, Method 204,
 Test Condition D
Shock:
 MIL-STD-202, Method 213,
 Test Condition K
 Fluid

Operating Range (cont.)
Thermal Shock:
 MIL-STD-202, Method 107,
 Test Condition B
Salt Spray:
 MIL-STD-202, Method 101,
 Test Condition B
Humidity:
 MIL-STD-202, Method 106
 (No Vibration Step 7B)
Contact Retention:
 16 ga. Contact = 30 lbs Min.
 8 ga. Contact = 55 lbs Min.
Fluid Immersion:
 Materials and Marking Shall Be
 Resistant to Skydrol LD-4 and
 MIL-H-83282 Hydraulic

Product Description

Power Bus 3 is a lightweight, compact and fully enclosed 3-phase, 73 amp, 1000 VAC power distribution bus for aircraft and other applications. The unique Power Bus 3 provides significant advantages in terms of size and weight reduction and strength increases over existing power bus devices. The construction features a rigid extruded polyetherimide channel that contains and isolates the three bus phases in individual chambers. Stackable modular sections are welded ultrasonically to the extrusion to build the Power bus 3 to any desired length.

Power Bus Dimensions

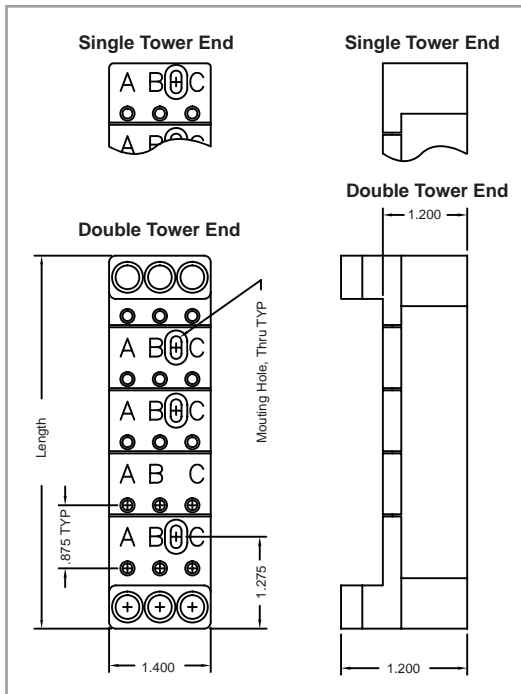

Amphenol Pcd Power Bus

Single Tower End

Output Sets	APCD P/N	Length
5	SSM300105	4.300
6	SSM300106	5.175
7	SSM300107	6.050
9	SSM300108	6.925
9	SSM300109	7.800
10	SSM300110	8.675
11	SSM300111	9.550
12	SSM300112	10.425
13	SSM300113	11.300
14	SSM300114	12.175
15	SSM300115	13.050
16	SSM300116	13.925
17	SSM300117	14.800
18	SSM300118	15.675
19	SSM300119	16.550
20	SSM300120	17.425
21	SSM300121	18.300
22	SSM300122	19.175
23	SSM300123	20.050
24	SSM300124	20.925
25	SSM300125	21.800
26	SSM300126	22.675
27	SSM300127	23.550
28	SSM300128	24.425
29	SSM300129	25.300
30	SSM300130	26.175
31	SSM300131	27.050
32	SSM300132	27.925
33	SSM300133	28.800
34	SSM300134	29.675
35	SSM300135	30.550
36	SSM300136	31.425

Double Tower End

Output Sets	APCD P/N	Length
5	SSM300205	5.175
6	SSM300206	6.050
7	SSM300207	6.925
9	SSM300208	7.800
9	SSM300209	8.675
10	SSM300210	9.550
11	SSM300211	10.425
12	SSM300212	11.300
13	SSM300213	12.175
14	SSM300214	13.050
15	SSM300215	13.925
16	SSM300216	14.800
17	SSM300217	15.675
18	SSM300218	16.550
19	SSM300219	17.425
20	SSM300220	18.300
21	SSM300221	1*9.175
22	SSM300222	20.050
23	SSM300223	20.925
24	SSM300224	21.800
25	SSM300225	22.675
26	SSM300226	23.550
27	SSM300227	24.425
28	SSM300228	25.300
29	SSM300229	26.175
30	SSM300230	27.050
31	SSM300231	27.925
32	SSM300232	28.800
33	SSM300233	29.675
34	SSM300234	30.550
35	SSM300235	31.425
36	SSM300236	32.300

Crimp Removable Socket Contacts

MIL-C-39029/5, MIL-C-39029/101

Materials:

Body:

Copper Alloy, Hard Gold
Plated per MIL-G-45204

Hood:

Stainless Steel Passivated

Performance:

Performance:

Performance in Accord with
SAE-AS39209 and Related
Specifications

M39029/5 Contact Dimensions

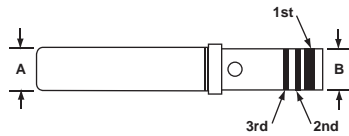

M39029/101 Contact Dimensions

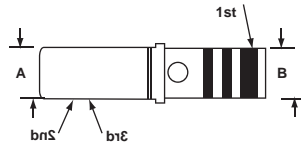

Contacts



Contacts By Relay Socket

M39029/5 Contacts Used with
M12883/40, /41, /47, & /48 Relay Sockets

M39029/101 Contacts Used with
M12883/44, /45, /46, & /52 Relay Sockets

Contact Design Characteristics

Bin Code	Military P/N	APCD P/N	Pin Size	Wire Size	1st	2nd	3rd	A (Max)	B (Max)
M39029/5 Contacts					Color Bands				
115	M39029/5-115	CNS511500	20	20	Brown	Brown	Green	.078	.078
116	M39029/5-116	CNS511600	16	16	Brown	Brown	Blue	.113	.103
117	M39029/5-117	CNS511700	16	20	Brown	Brown	Violet	.113	.078
118	M39029/5-118	CNS511800	12	12	Brown	Brown	Gray	.161	.151
119	M39029/5-119	CNS511900	12	16	Brown	Brown	White	.161	.103
M39029/101 Contacts					Color Bands				
551	M39029/101-551	CNS101551	22	28	Green	Green	Brown	.060	.048
552	M39029/101-552	CNS101552	22	22	Green	Green	Red	.060	.048
553	M39029/101-553	CNS101553	20	20	Green	Green	Orange	.076	.070
554	M39029/101-554	CNS101554	16	16	Green	Green	Yellow	.108	.103

Contact Installation Tooling

Bin Code	Basic Crimping Tool	Positioner	Wired Contact Installing Tool	Removal Tool
M39029/5 Contacts				
115	M22520/2-01, M22520/1-01 or M22520/7-01	M22520/2-02, M22520/1-02 Red, or M22520/7-02	M81969/14-02	M81969/14-02
116	M22520/1-01, M22520/7-01	M22520/1-02 Blue or M22520/7-03	M81969/14-03	M81969/14-03
117	M22520/1-01, M22520/7-01	M22520/1-02 Blue or M22520/7-03	M81969/14-02	M81969/14-02
118	M22520/1-01	M22520/1-02 Yellow	M81969/14-04	M81969/14-04
119	M22520/1-01	M22520/1-02 Yellow	M81969/14-03	M81969/14-03
M39029/101 Contacts				
551	M22520/7-01	M81969/7-11	M81969/16-04	M81969/16-04
552	M22520/7-01	M22520/7-11	M81969/16-04	M81969/16-04
553	M22520/7-01	M22520/7-12	M81969/16-01	M81969/16-01
554	M22520/7-01	M22520/7-13	M81969/16-03	M81969/16-02

Amphenol Pcd

Contacts



Crimp Removable Contacts

MIL-C-39029/1, MIL-C-39029/22

Materials:

Body:

Copper Alloy, Hard Gold Plated per MIL-G-45204

Hood:

Stainless Steel Passivated

Performance:

Performance:

Performance in Accord with SAE-AS39209 and Related Specifications

M39029/1 Contact Dimensions

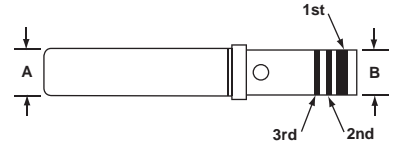

M39029/22 Contact Dimensions

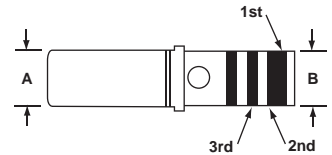

Contacts By Relay Socket

M39029/1 Contacts Used with M81714 Series I, TJE, TJSE, TJHD, and TJM Modules

M39029/22 Contacts Used with M81714/60, /61, /63, Series II Socket Junction Modules

Contact Design Characteristics

Bin Code	Military P/N	APCD P/N	Pin Size	Wire Size	1st	2nd	3rd	A (Max)	B (Max)
M39029/1 Contacts					Color Bands				
100	M39029/1-100	CNS068000	16	22	Brown	Black	Black	.062	.051
101	M39029/1-101	CNS060000	16	20	Brown	Black	Brown	.063	.078
102	M39029/1-102	CNS037000	14	16	Brown	Black	Red	.078	.105
103	M39029/1-103	CNS072000	12	12	Brown	Black	Orange	.095	.153
507	M39029/1-507	CNS022507	20	22D	Green	Black	Violet	.041	.048
M39029/22 Contacts					Color Bands				
191	M39029/22-191	CNS113900	22	22	Brown	White	Brown	.060	.048
192	M39029/22-192	CNS070900	20	20	Brown	White	Red	.076	.070
193	M39029/22-193	CNS072900	16	16	Brown	White	Orange	.108	.103
605	M39029/22-605	CNS123900	12	12	Blue	Black	Green	.168	.152

Contact Installation Tooling

Bin Code	Basic Crimping Tool	Positioner	Installing Tool	Wired Contact Removal Tool
M39029/1 Contacts				
100	M22520/2-01	M22520/2-11	M81969/14-02	M81969/14-02
101	M22520/1-01, M22520/2-01	M22520/1-02 Red, M22520/2-11	M81969/14-02	M81969/14-02
102	M22520/1-01	M22520/1-02 Blue	M81969/14-03	M81969/14-03
103	M22520/1-01	M22520/1-02 Yellow	M81969/14-04	M81969/14-04
507	M22520/2-01	M22520/2-32	M81969/14-01, or/1-04 or /8-01 or /8-02	M81969/14-01, or/1-04 or /8-01 or /8-02
M39029/22 Contacts				
191	M22520/7-01	M81969/7-11	M81969/14-01	M81969/14-01
192	M22520/7-01	M22520/7-12	M81969/14-10	M81969/14-10
193	M22520/7-01	M22520/7-13	M81969/14-03	M81969/14-03
605	M22520/1-01	Daniels, TH343 or TP405	M81969/16-03	M81969/16-03

Crimp Removable Socket Contacts

MIL-C-39029/92

Materials:

Body:

Copper Alloy, Hard Gold
Plated per MIL-G-45204

Hood:

Stainless Steel Passivated

Performance:

Performance:

Performance in Accord with
MIL-C-39209 and Related
Specifications

M39029/92 Contact Dimensions

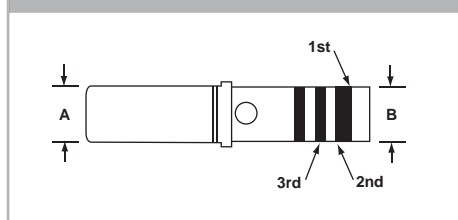

Contacts



Contacts By Relay Socket

M39029/92 Contacts Used with
M12883/40, /41, /47, /48, /54, /55 Relay Sockets

Contact Design Characteristics

Bin Code	Military P/N	APCD P/N	Pin Size	Wire Size	1st	2nd	3rd	A (Max)	B (Max)
M39029/92 Contacts									
531	M392029/92-531	CNS115900	22	22	Green	Orange	Brown	.062	.053
532	M392029/92-532	CNS074900	20	20	Green	Orange	Red	.078	.078
533	M392029/92-533	CNS126900	16	16	Green	Orange	Orange	.113	.103
534	M392029/92-534	CNS127900	16	20	Green	Orange	Yellow	.113	.078
535	M392029/92-535	CNS128900	12	12	Green	Orange	Green	.161	.151
536	M392029/92-536	CNS129900	12	16	Green	Orange	Blue	.161	.103

Contact Installation Tooling

Bin Code	Basic Crimping Tool	Positioner	Installing Tool	Wired Contact Removal Tool
M39029/92 Contacts				
531	M22520/2-01	Daniels K1561	M81969/8-03, /14-01	M81969/8-04, /14-01
532	M22520/1-01, M22520/2-01, M22520/7-01	M22520/1-02 Red, M22520/2-02, M22520/7-02	M81969/8-05, /14-02	M81969/8-06, /14-02
533	M22520/1-01 or M22520/7-01	M22520/1-02 Blue or M22520/7-03	M81969/8-07, /14-03	M81969/8-08, /14-03
534	M22520/1-01 or M22520/7-01	M22520/1-02 Blue or M22520/7-03	M81969/8-07, /14-03	M81969/8-08, /14-03
535	M22520/1-01	M22520/1-02 Yellow	M81969/8-09, /14-04	M81969/8-10, /14-04
536	M22520/1-01	M22520/1-02 Yellow	M81969/8-09, /14-04	M81969/8-10, /14-04

Компания «Life Electronics» занимается поставками электронных компонентов импортного и отечественного производства от производителей и со складов крупных дистрибьюторов Европы, Америки и Азии.

С конца 2013 года компания активно расширяет линейку поставок компонентов по направлению коаксиальный кабель, кварцевые генераторы и конденсаторы (керамические, пленочные, электролитические), за счёт заключения дистрибьюторских договоров

Мы предлагаем:

- Конкурентоспособные цены и скидки постоянным клиентам.
- Специальные условия для постоянных клиентов.
- Подбор аналогов.
- Поставку компонентов в любых объемах, удовлетворяющих вашим потребностям.
- Приемлемые сроки поставки, возможна ускоренная поставка.
- Доставку товара в любую точку России и стран СНГ.
- Комплексную поставку.
- Работу по проектам и поставку образцов.
- Формирование склада под заказчика.
- Сертификаты соответствия на поставляемую продукцию (по желанию клиента).
- Тестирование поставляемой продукции.
- Поставку компонентов, требующих военную и космическую приемку.
- Входной контроль качества.
- Наличие сертификата ISO.

В составе нашей компании организован Конструкторский отдел, призванный помогать разработчикам, и инженерам.

Конструкторский отдел помогает осуществить:

- Регистрацию проекта у производителя компонентов.
- Техническую поддержку проекта.
- Защиту от снятия компонента с производства.
- Оценку стоимости проекта по компонентам.
- Изготовление тестовой платы монтаж и пусконаладочные работы.



Тел: +7 (812) 336 43 04 (многоканальный)
Email: org@lifeelectronics.ru